

# THE MK.II DIY SHEET METAL SELF-LOADING PISTOL

## CONSTRUCTION PLANS

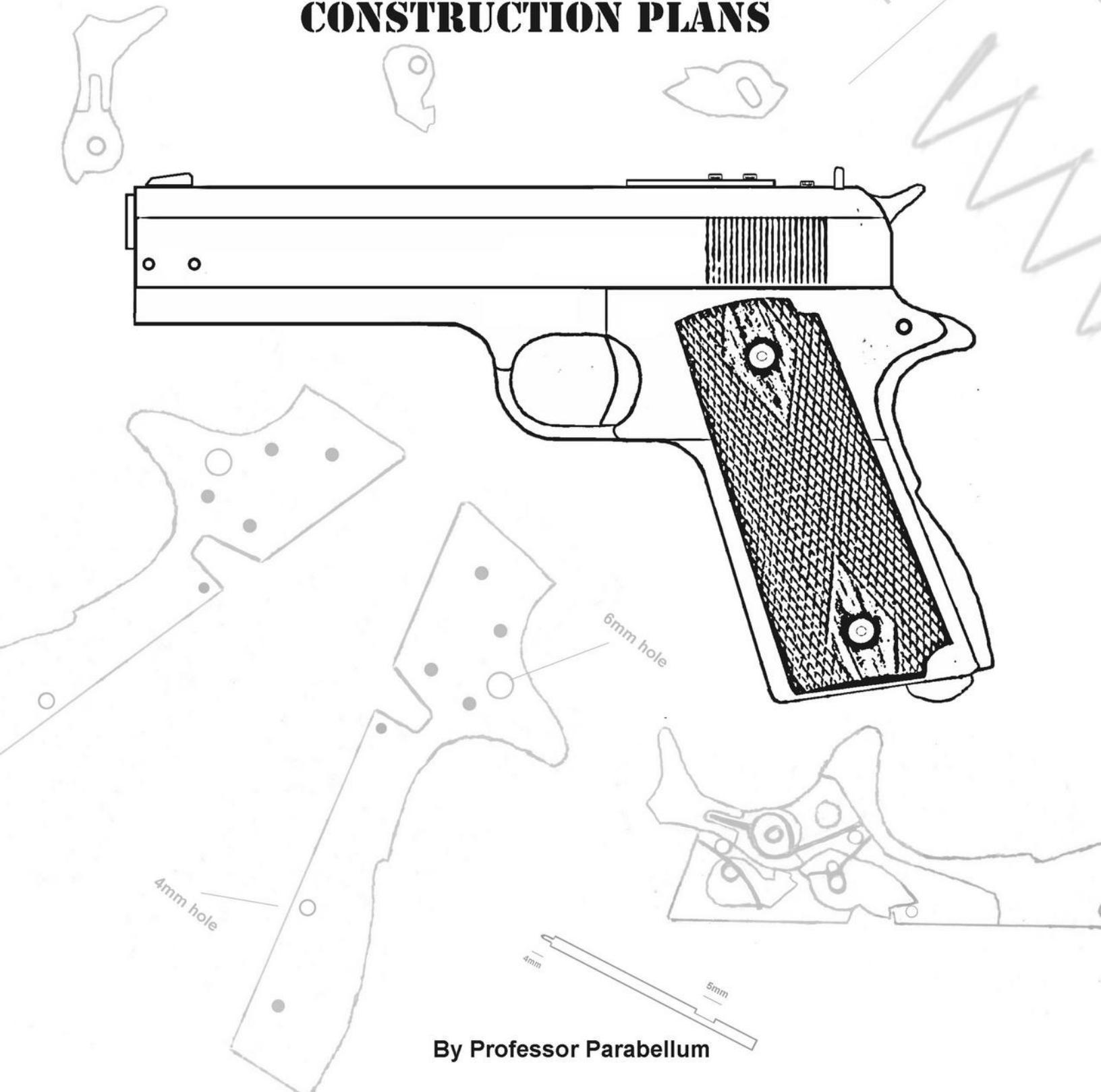

By Professor Parabellum

# .32 ACP SMSLP MK2

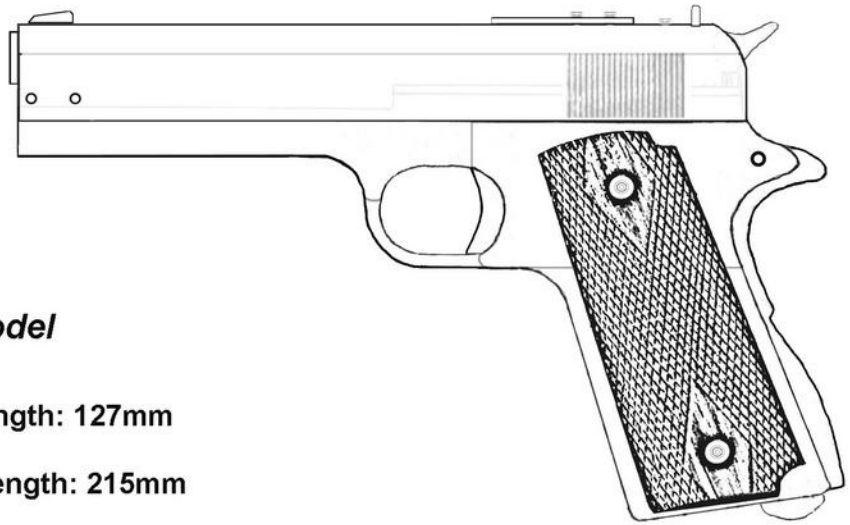

## *Standard model*

- Barrel length: 127mm
- Overall length: 215mm

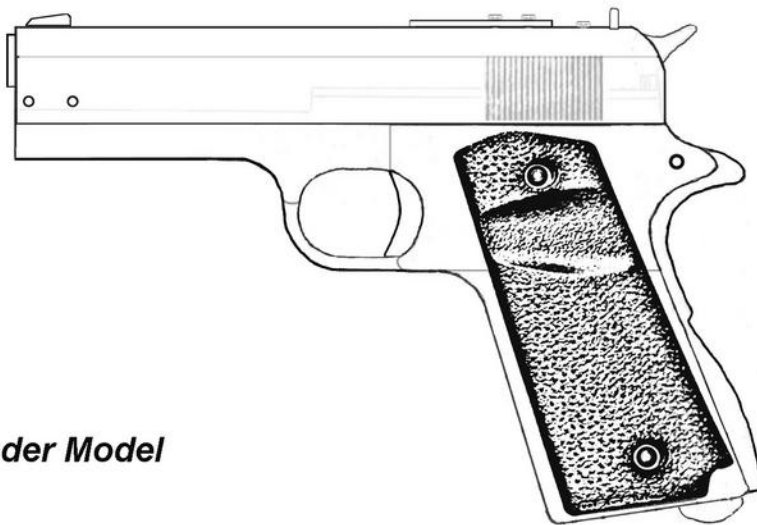

## *Commander Model*

- Barrel length: 108mm
- Overall length: 195mm

All pages included should be printed out on 8.5 x 11 US letter paper. Each component template is drawn to scale and can be cut out and glued to their respective thickness of material or used as a reference for measurements. Make sure the ruler at the bottom left of each sheet is 2 inches in length. Alternatively, take a screen-shot and enlarge the plans using a computer program until the ruler is the correct length, then trace the parts needed onto a sheet of paper taped over your monitor screen.

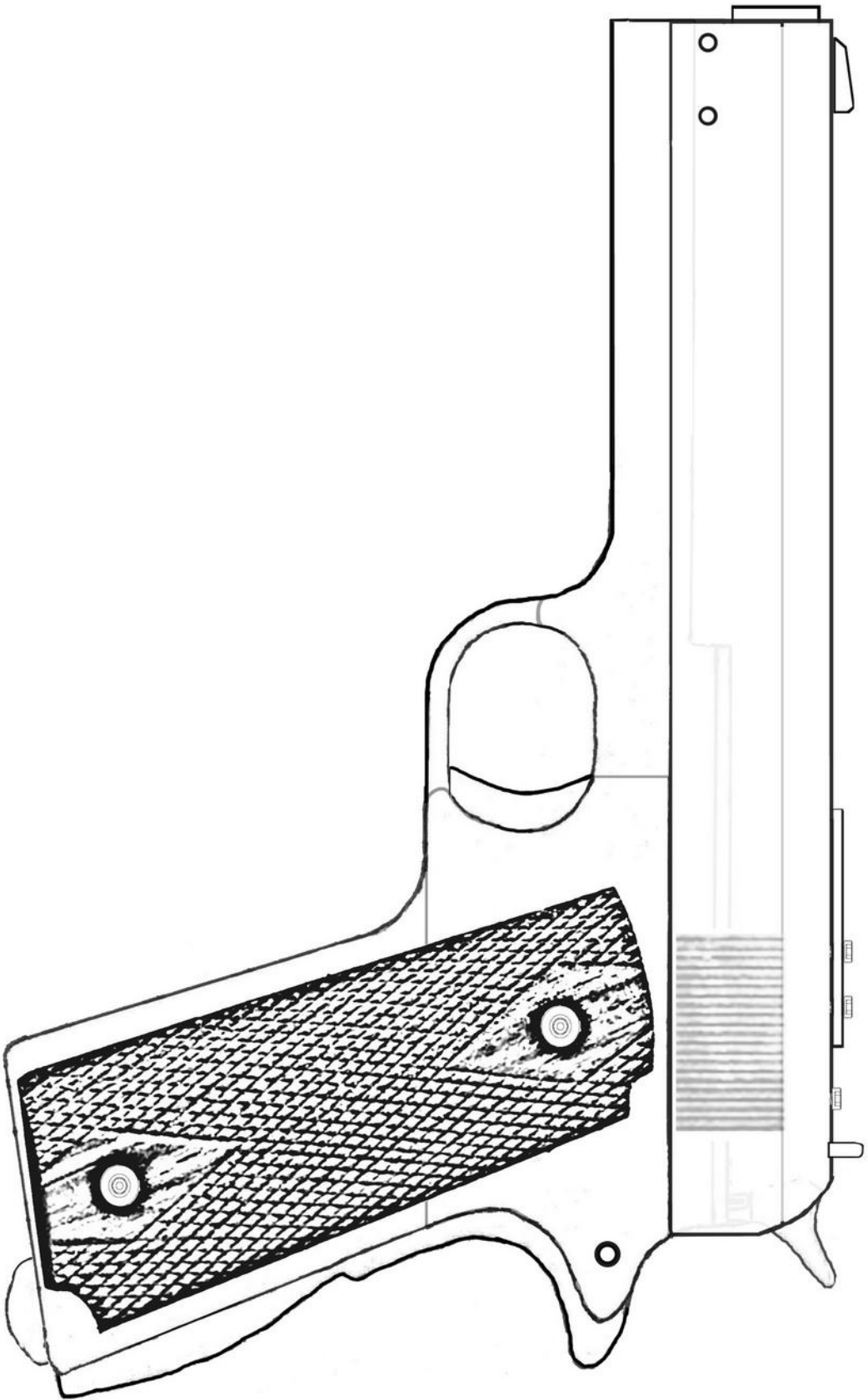

2 inches

Print on 8.5x11 US letter paper

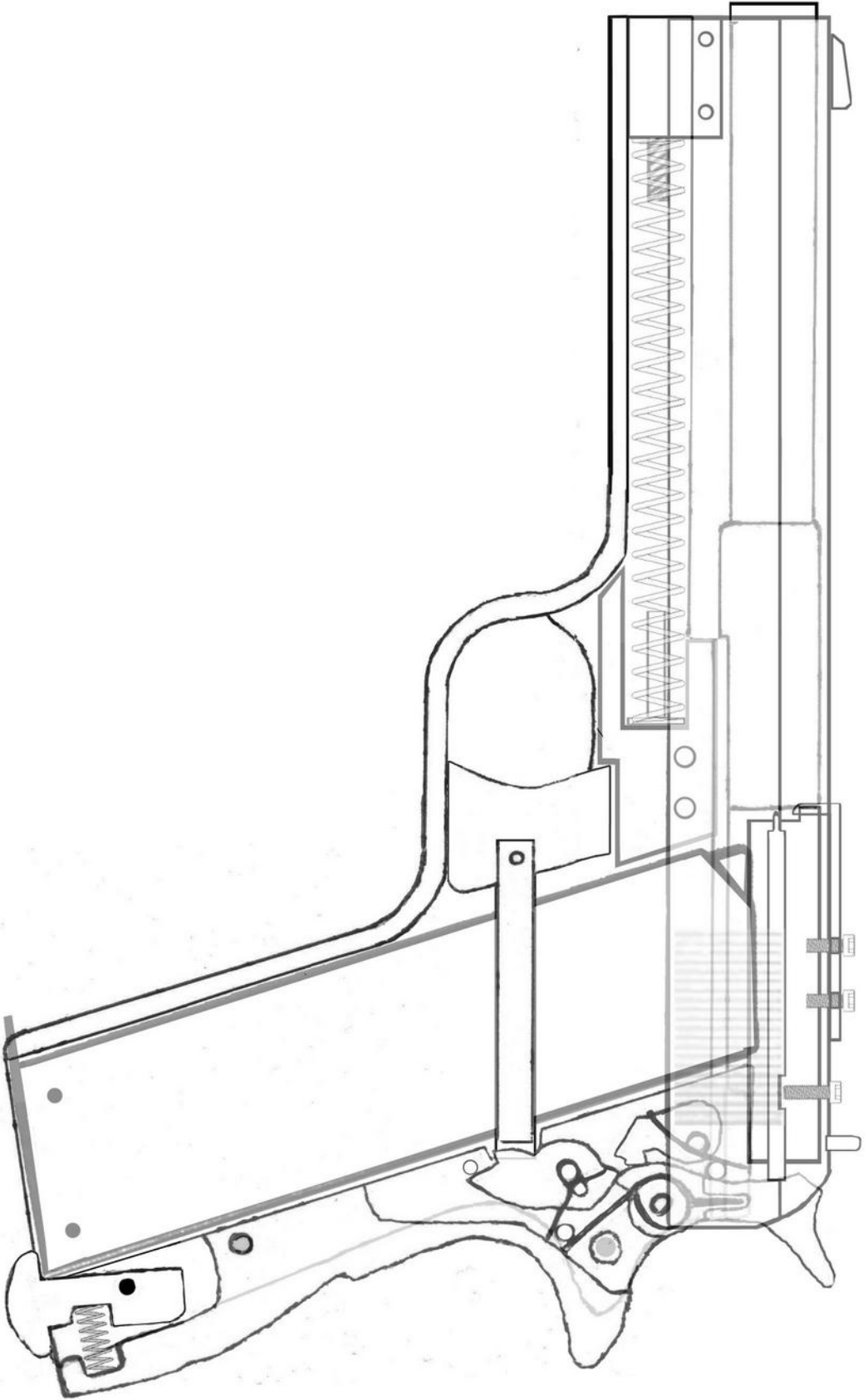

2 inches

Print on 8.5x11 US letter paper

## Right side frame plate

Cut from 14 gauge (2mm) thick mild steel sheet



# Left side frame plate

Cut from 14 gauge (2mm) thick mild steel sheet

To form slide rails, weld a continuous bead along top of both plates  
and grind to shape using an angle grinder or dremel until 2mm high x 2mm wide

*Alternatively weld on two steel strips*

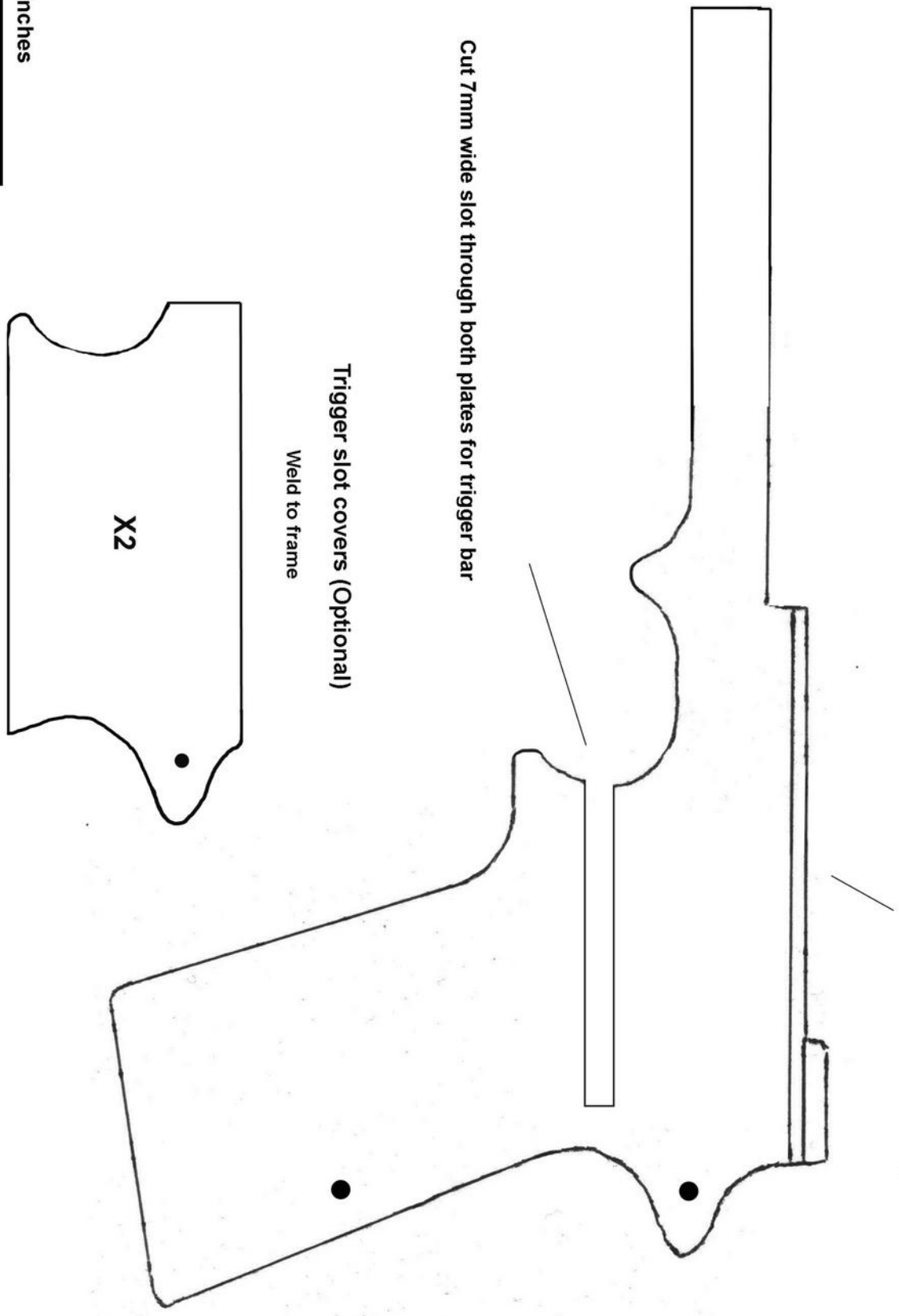

Cut 7mm wide slot through both plates for trigger bar

Trigger slot covers (Optional)

Weld to frame

X2

2 inches

# Trigger guard

- Bend to profile from an 11" long strip of 14mm wide, 3mm thick mild steel strap.
- Clamp inbetween frame plates and securely weld in place.

Grind welds smooth and sand edges with a flap wheel to a smooth profile

2 inches

Print on 8.5x11 US letter paper

Grind away 3mm for magazine base plate clearance

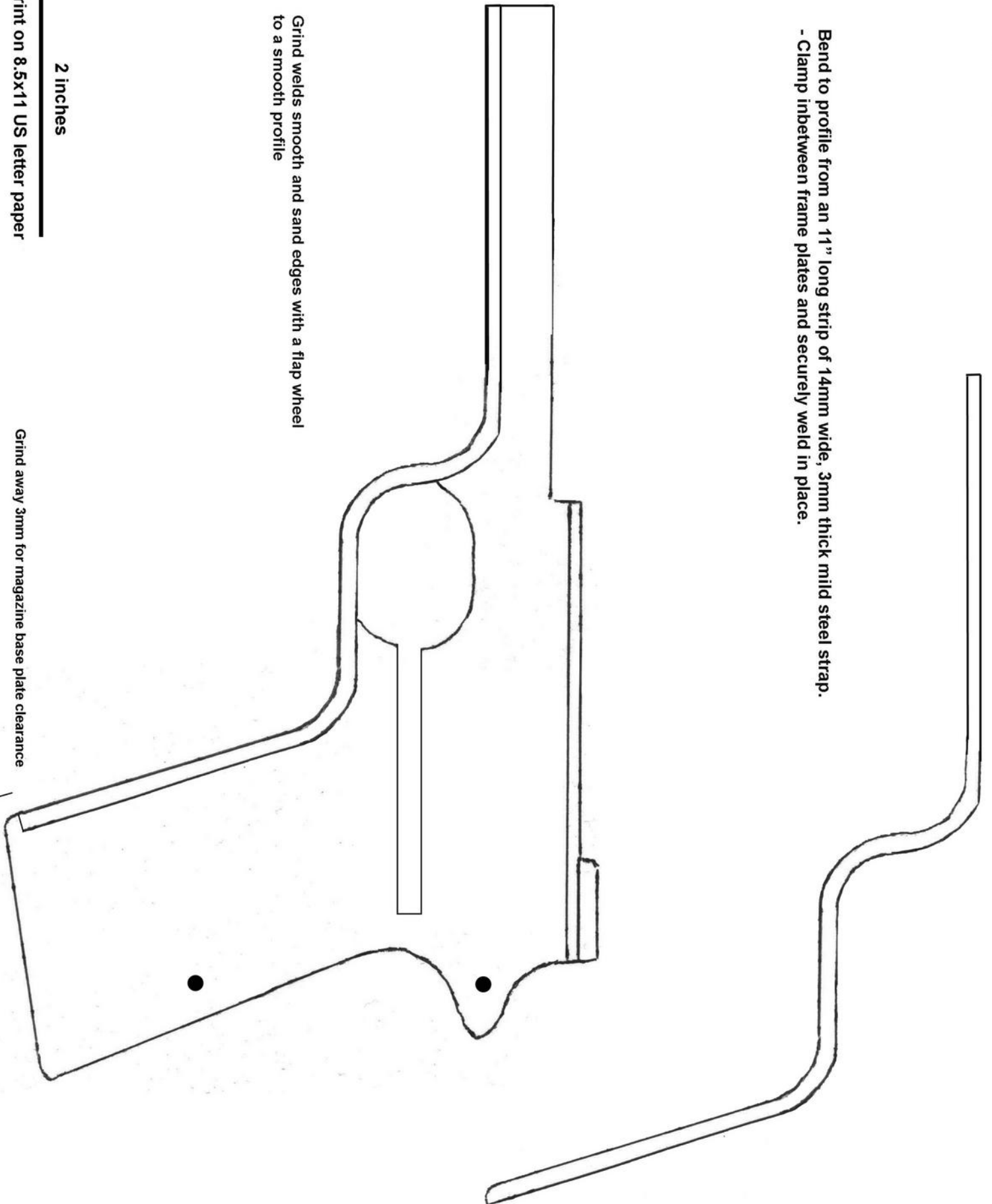

# Hammer pack side plates

Cut from 3mm thick mild steel sheet. Clamp both plates together before drilling.

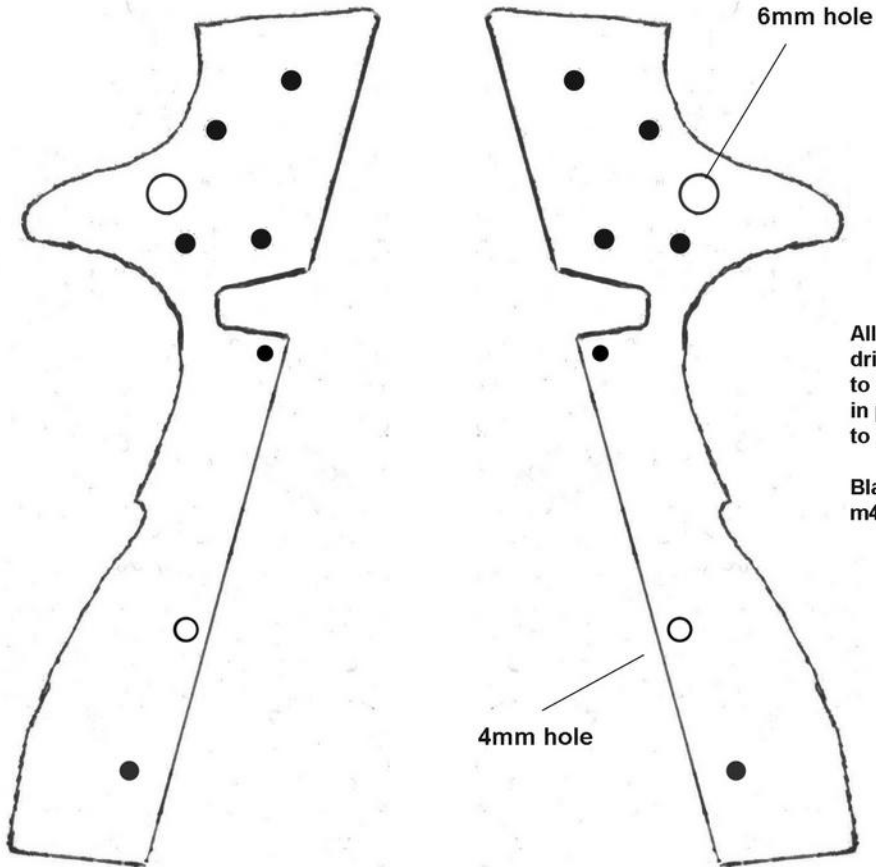

All black holes on right side plate are drilled with a 3mm bit and tapped to accept a 14mm long m4 bolt threaded in place, beheaded and sealed with epoxy to create six fixed pins, each 10mm high.

Black holes on left plate are drilled with an m4 bit. The pack should snap together closed.

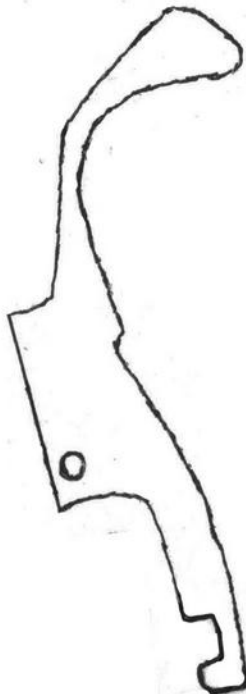
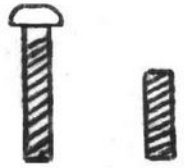

## Back strap

Cut from 8mm thick aluminum, plastic or steel plate

2 inches



# Hammer mechanism

## Hammer

(8mm plate)



## Sear

(Both 4mm plate)



## Disconnecter



Use a needle file to elongate 4mm hole in disconnecter

## Side profile

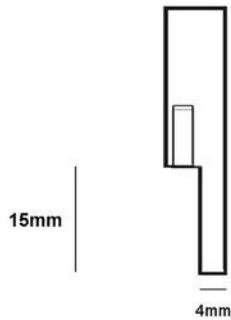

File down lower area until coil spring sits flush  
- use dremel slitting disc to cut spring arm slot

## Hammer spring

Bend to profile from heavy 19 gauge + spring steel music wire



## Sear spring

Bend to profile from 0.25 music wire

Bend end marked over edge of sear



## Disconnecter spring

0.25 music wire



Bend point marked so end wraps just below top point on disconnecter

2 inches

# Hammer pack assembled

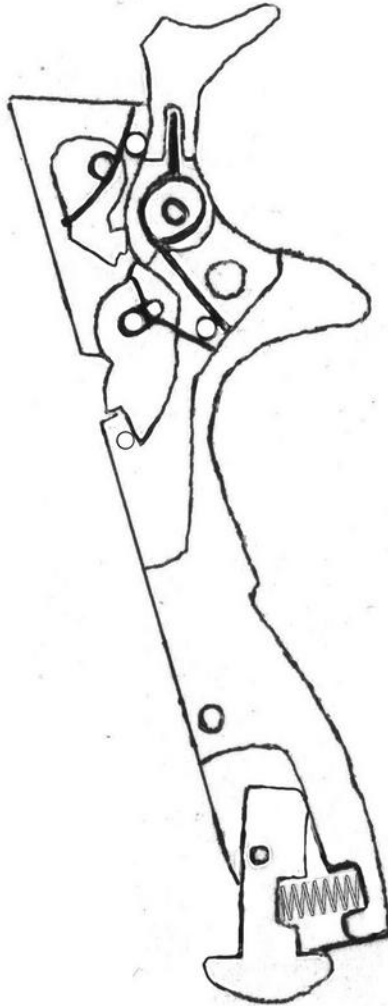

## Magazine catch

8mm thick steel or aluminum

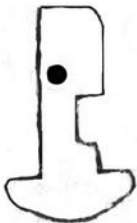

5mm dia x 15mm long compression spring

2 inches

---

## Sear disconnection sequence

1  
Hammer cocked:



2  
Trigger pulled:



3  
Hammer falling:



4  
Hammer resting forward:



5  
Trigger released:



# Trigger

## Trigger block

Cut from 14mm thick aluminum / plastic

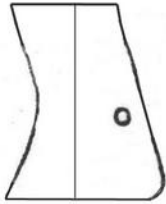

File front half down to 6mm - round off edges

## Trigger bar

Bend to shape from a 115mm length of 1mm steel strip. Pin to trigger.

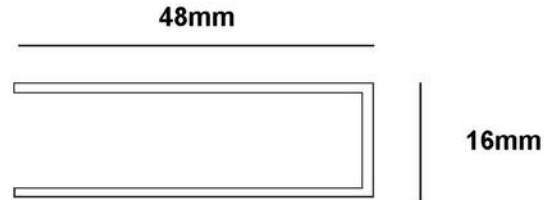

*Side view:*

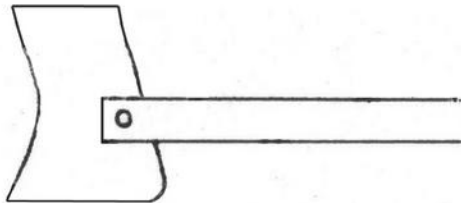

*Top view:*

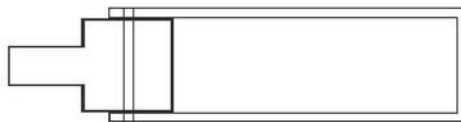

2 inches

# Barrel

7.5mm inner dia, 2.75mm wall

127mm long

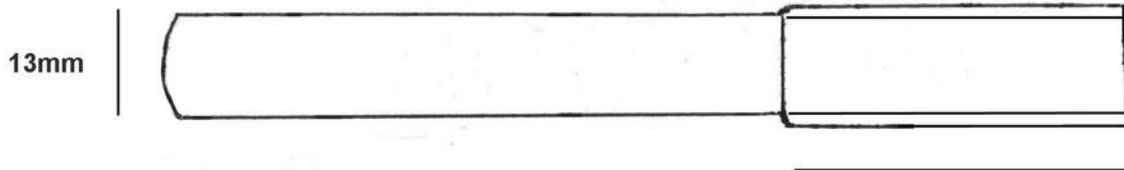

45mm

**Barrel collar**

(5/8" / 16mm steel tube, 1.5mm wall)

Solder or weld in place

Cut 6mm wide slot at top of barrel entrance to accommodate front of extractor



Bevel entrance with 16mm + drill bit  
- form slight ramp profile on lower wall

## Barrel lug

Cut from 14mm thick steel plate  
- Can alternatively be laminated from multiple sheet metal pieces.

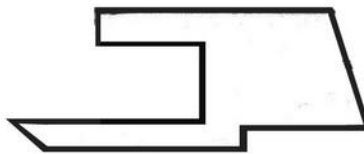

2 inches

# Barrel assembly

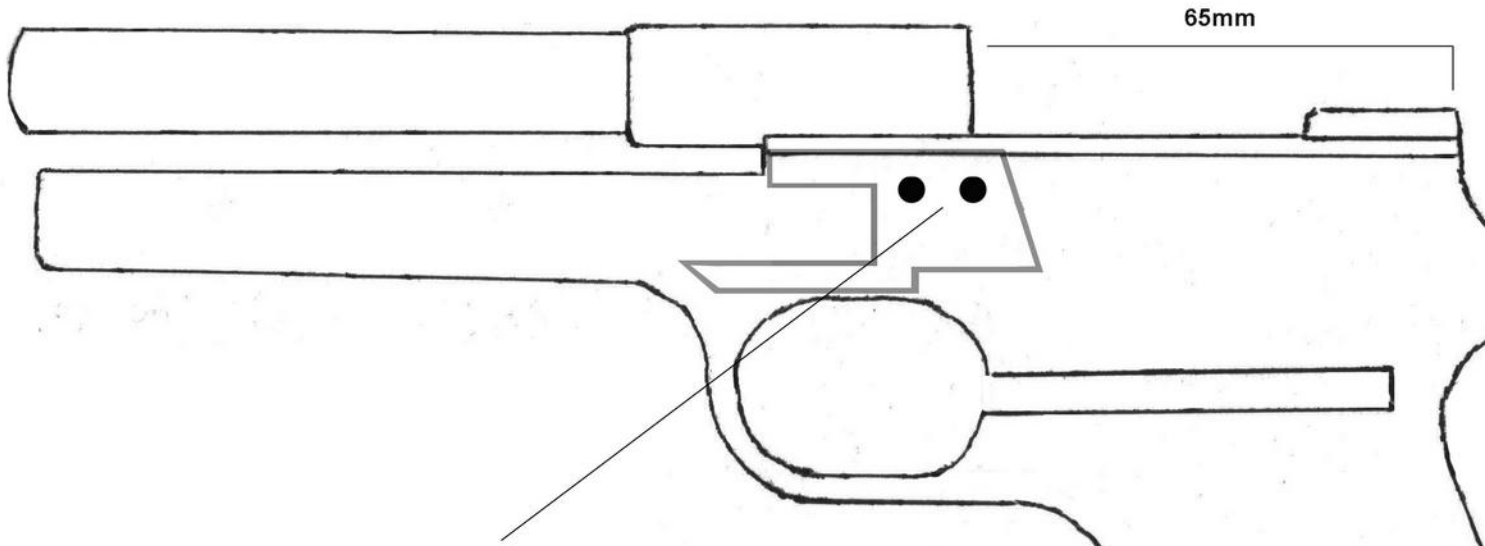
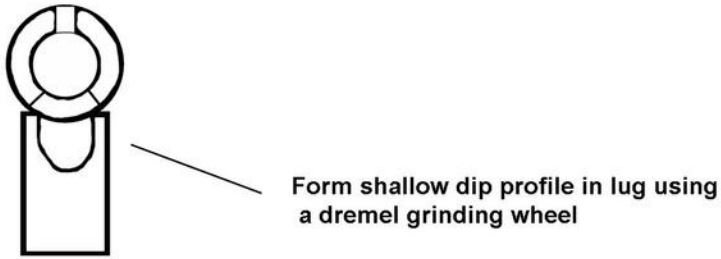
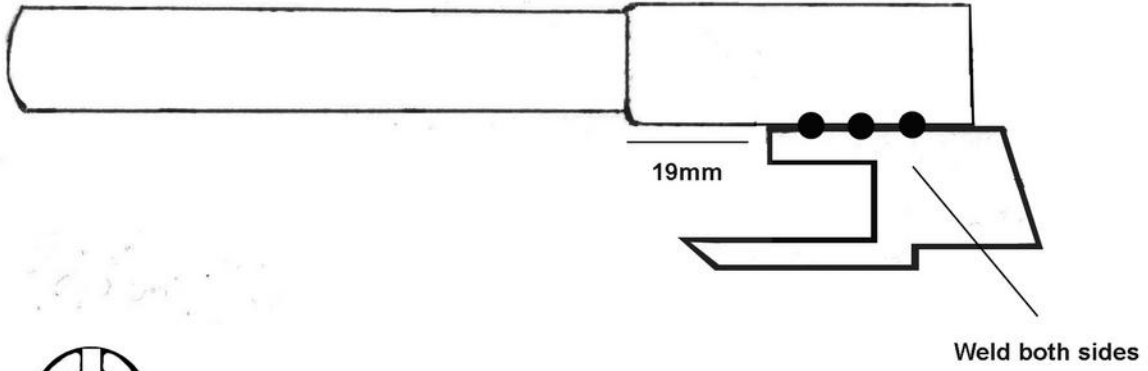

Secure barrel lug to frame using two 18mm long 5mm dia pins

2 inches

Print on 8.5x11 US letter paper

# Bolt piece

The bolt piece is made from a 57mm long length of 16mm (5/8") mild steel bar.

- Drill center with a 9.5mm drill bit until 3mm deep.
- Level hole flat using a 9.5mm drill bit having had its tip removed using an angle grinder
- Drill firing pin hole from front with a 3mm drill bit
- Drill from back using a 4.2mm drill bit, 50mm deep
- Cut feed channels using angle grinder to profile below:

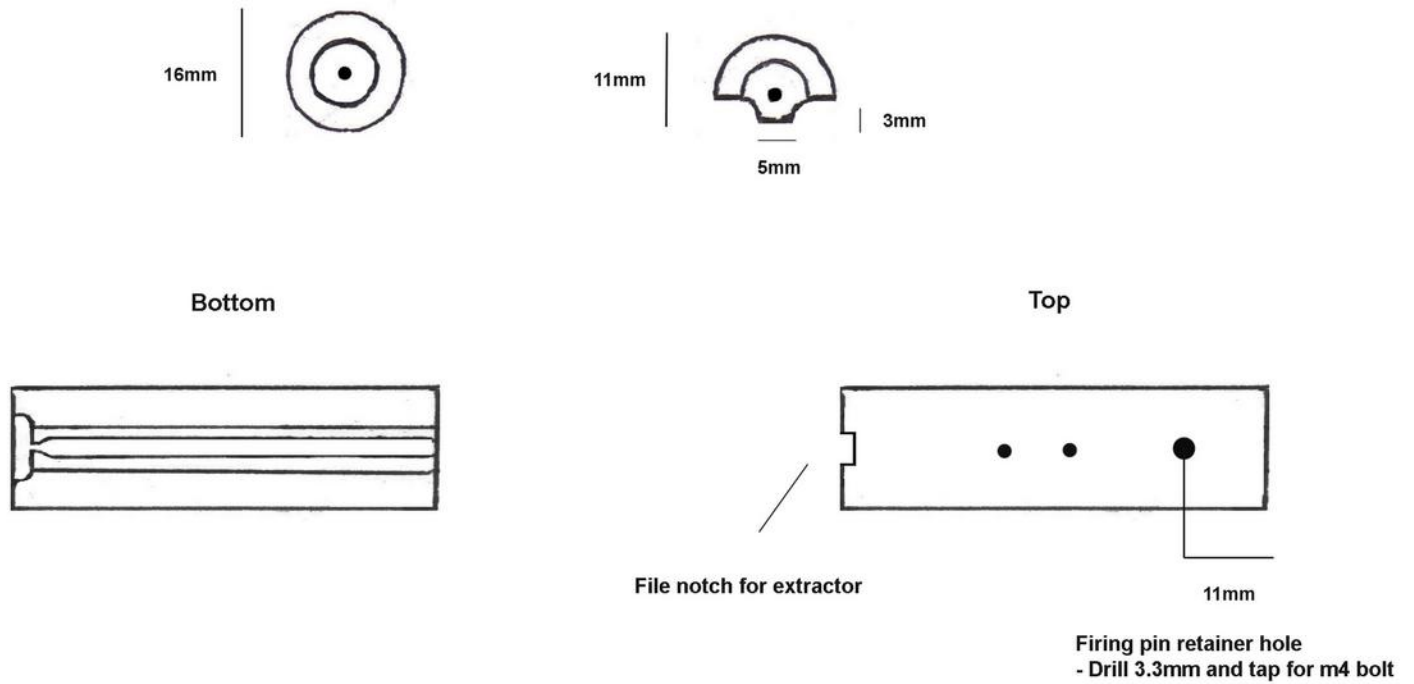

*Angle grinder 'milling'*

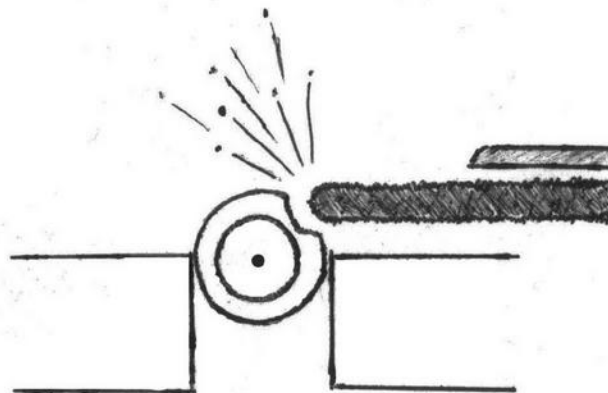

Secure bar in a vice and grind down sides using a small angle grinder fitted with a 2mm or 3mm grinding disc. Neaten cuts using a file.

2 inches

# Firing pin & extractor

## Firing pin

1/6" (4mm) dia silver steel bar. 60mm long.

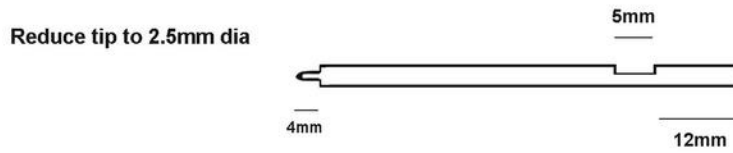

## Extractor

Bend from 45mm long, 5mm wide, 2mm thick steel strip.

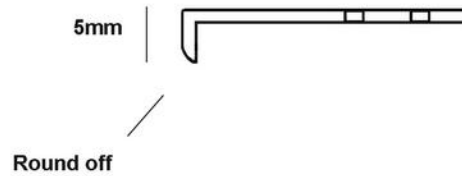

Hand fit so that front of claw is in contact with a cartridge rim when centered on bolt face. Cartridge should be able to slip under with ease. Retain using two m3 bolts, each 6mm long.

2 inches



## Slide side plates x 2

Cut from 3mm or 4mm thick mild steel plate, 18mm wide x 194mm long



Retention holes are only drilled once slide cover is welded in place and alignment with frame is established.

## Insides

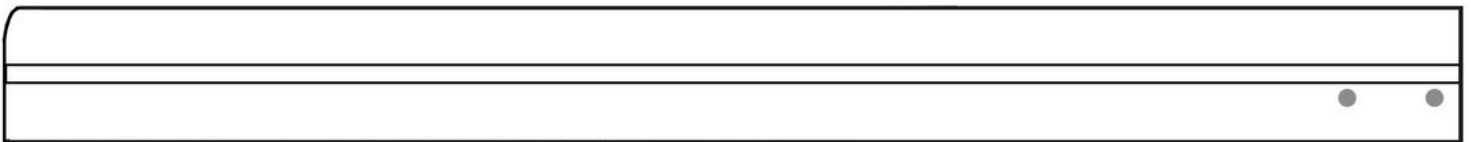

The slide rail cuts are formed by carefully using an angle grinder fitted with a 2mm grinding disc to form a shallow channel in the middle across the panel's entire length. Use a dremel and hand-file to neaten.

Clamp breech piece between slide plates centrally in-line with barrel and weld along each side in contact with slide. Grind down beads flush with sides.

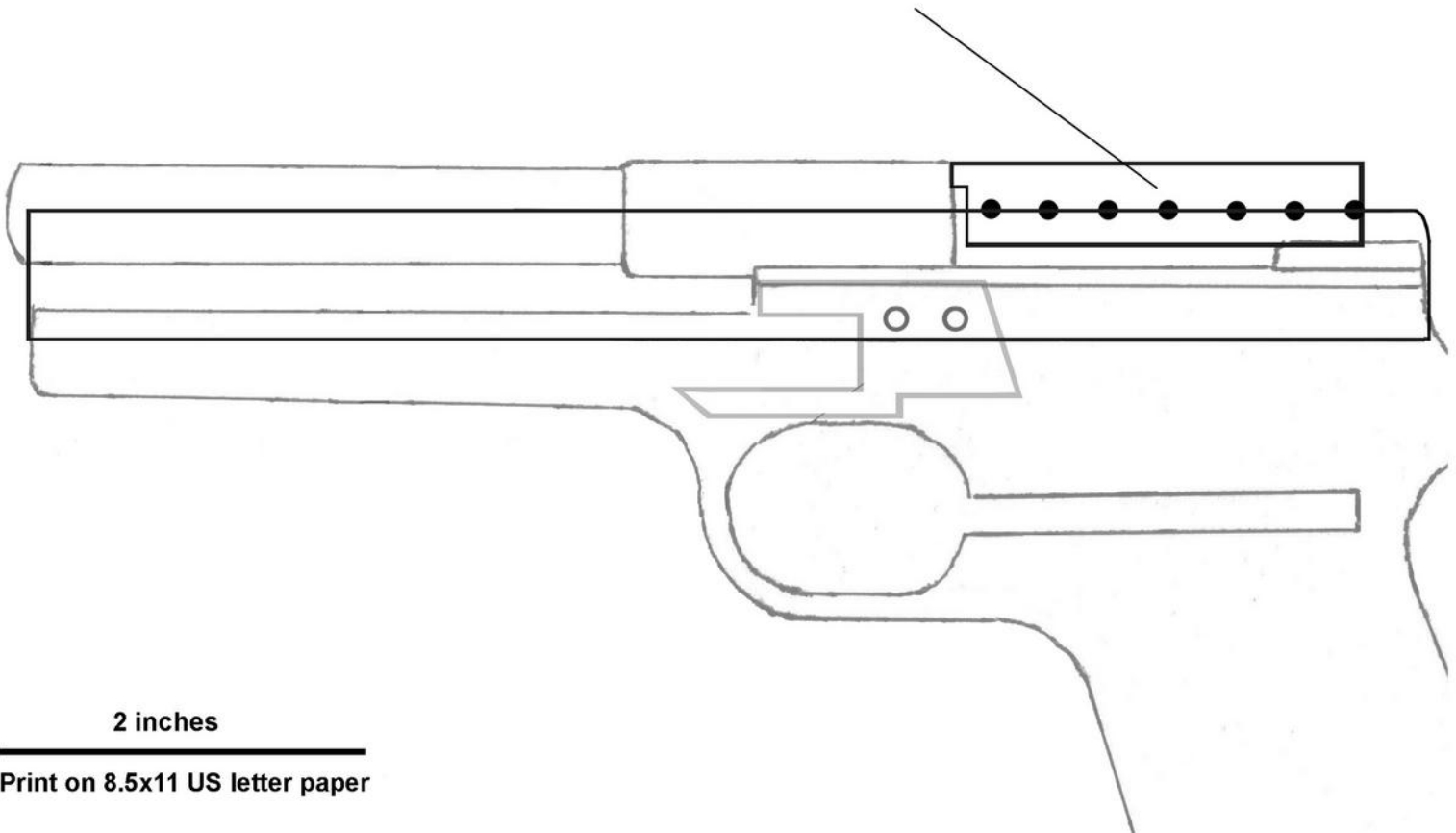

2 inches

# Slide cover

Create a U channel slide cover from a length of 2mm thick steel sheet. Ensure even wrap around with bolt and cut off flush with bottom of slide plates.

- 27mm high
- 194mm long

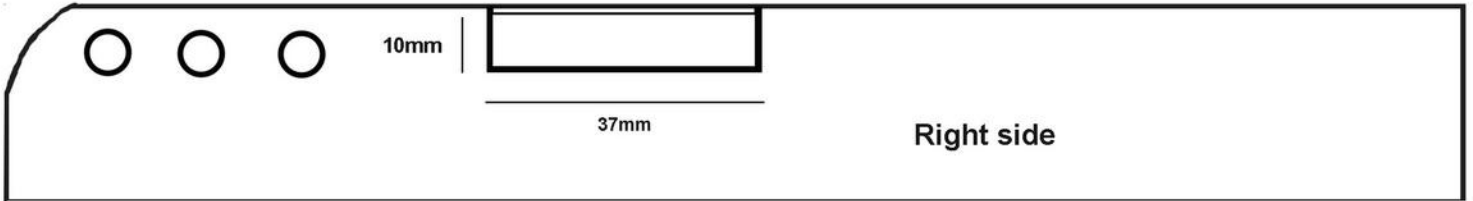

Drill three holes either side and spot weld cover permanently to inner bolt piece

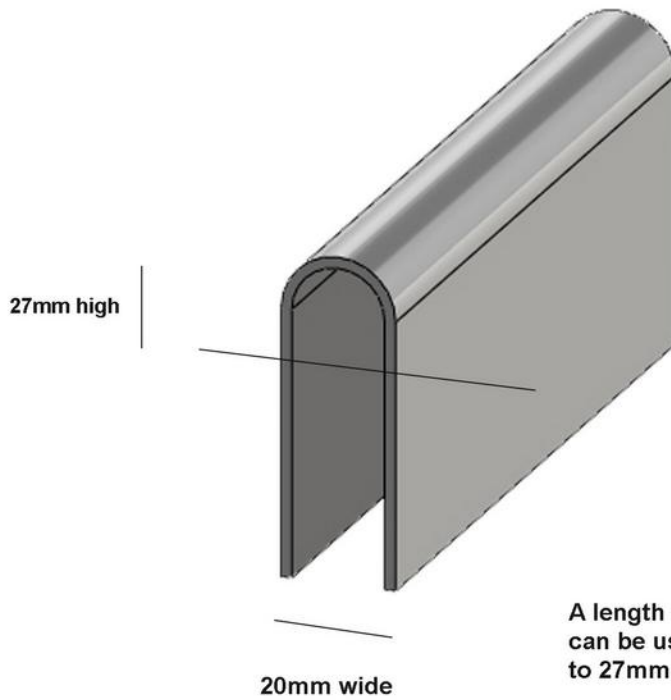
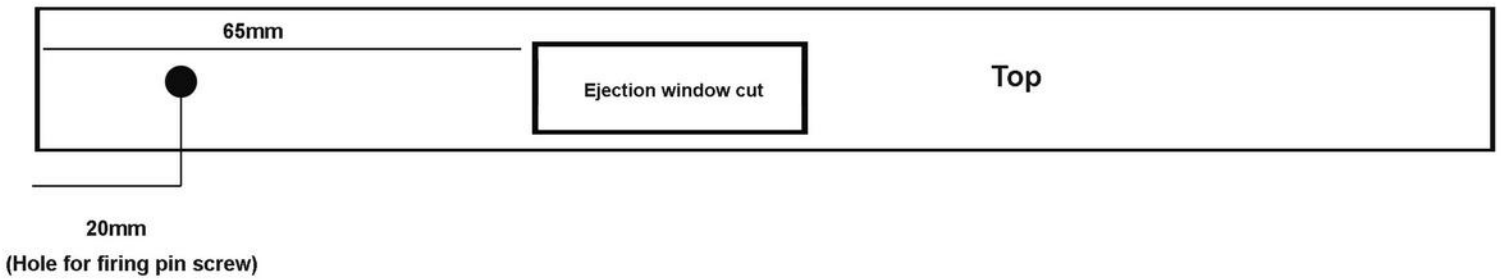

A length of 22mm dia round stock can be used as a forming bar. Cut U bend to 27mm in height.

2 inches

# Slide (assembled)

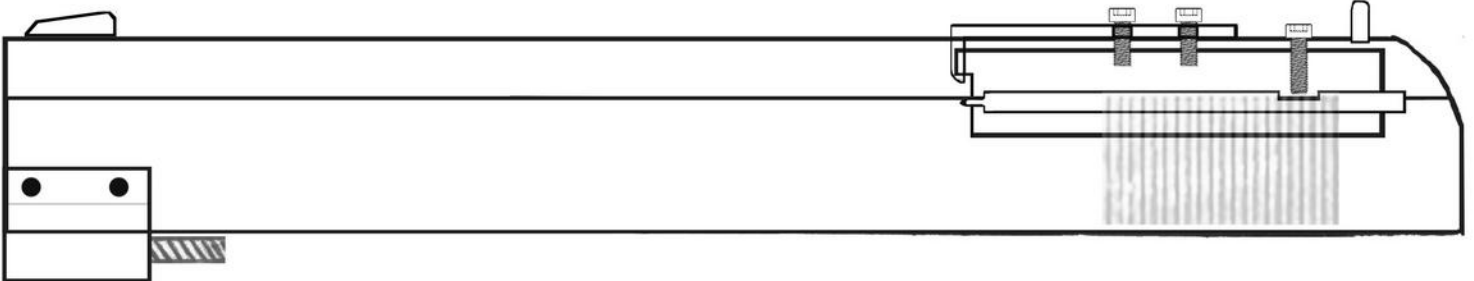

## Sights

3mm steel sheet. Dovetail into slide.

Serrate both sides using a jewelers saw

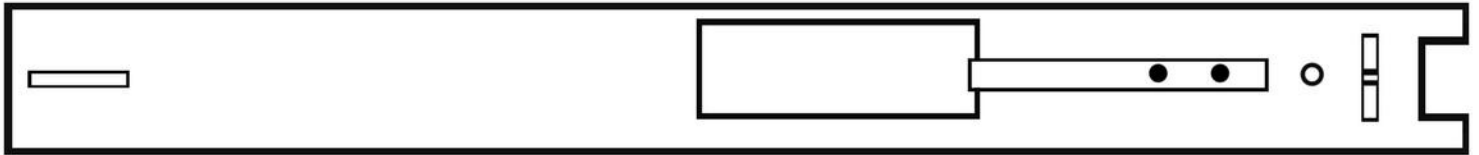
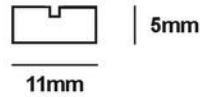
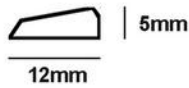

## Slide retainer lug

Tap a 15mm length of m5 bolt at rear to form recoil spring stud

Roll pins X2

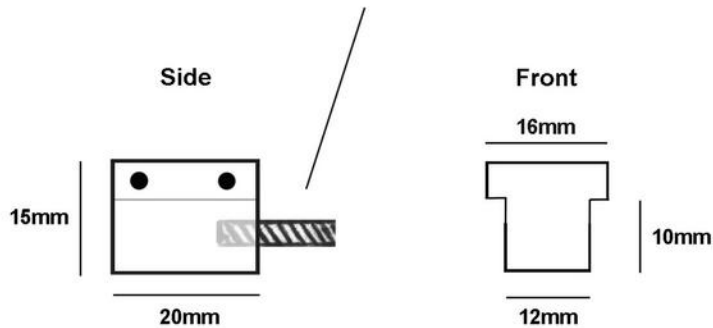

Can be modified from 5/8" steel square bar or cut from 1" round bar

Clamp lug securely in place at front of slide and drill through holes marked. Tap in two 1" long, 4mm diameter roll pins to retain.

2 inches

# Recoil spring

4.5"



Wire dia: .043 (1mm)

## Spring guide rod

20mm

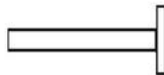

5mm dia rod. Solder an 8mm dia washer at base.

2 inches

# Magazine

Cut template out from 1mm thick mild steel sheet. Score on bend lines slightly using dremel.

Form around a 1/2" thick, 30mm wide block. Carefully weld together in spots along rear fold.

## Follower

Bend from a 50mm long, 10mm wide steel strip

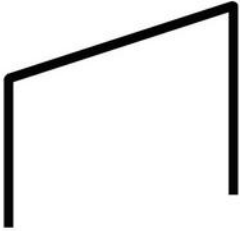

## Feed lips (rear)

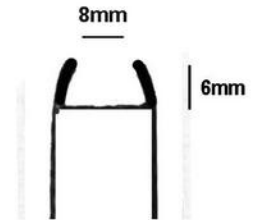

## Base plate

12mm thick aluminum

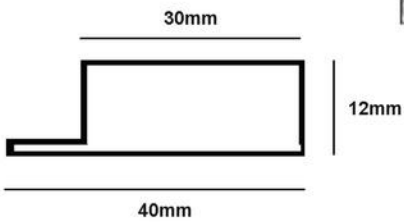

Secure base plate using two 14mm long seloc pins.

- Can be adjusted for optimum mag depth

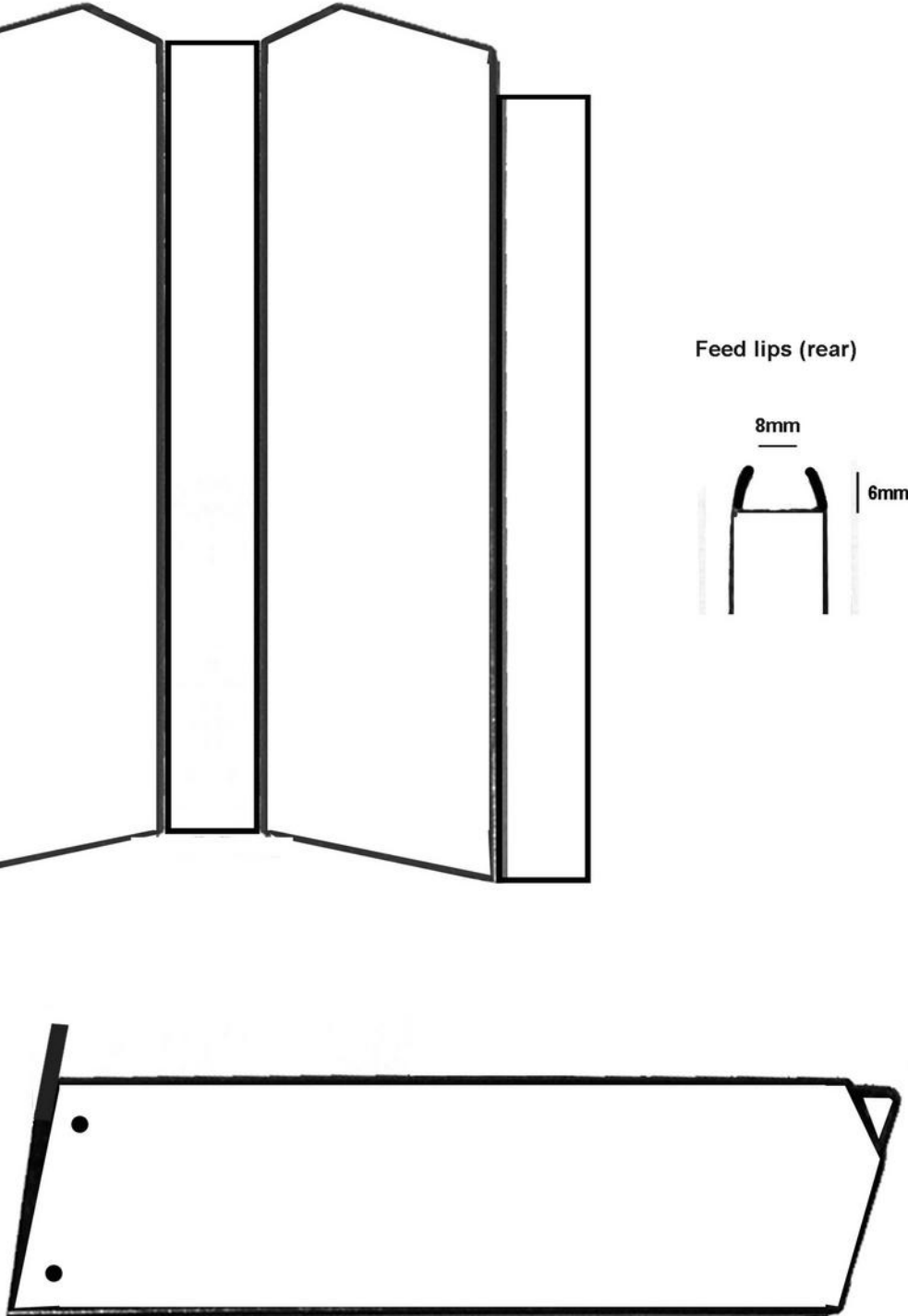

2 inches

Print on 8.5x11 US letter paper

# Magazine spring



Make a forming mandrel from a length of 1/4" (6mm thick) plate, 18mm wide, 12" long. Drill a hole at one end to tie a knot through.

Tightly form spring from 20 gauge spring steel music wire. Leave 15mm between coils.

Once complete, use pliers to form each coil into the correct rectangular shape.



2 inches

# Grip panels / stocks

1/4" thick hardwood or plastic

Secure to frame with four 5mm long M4 button head bolts

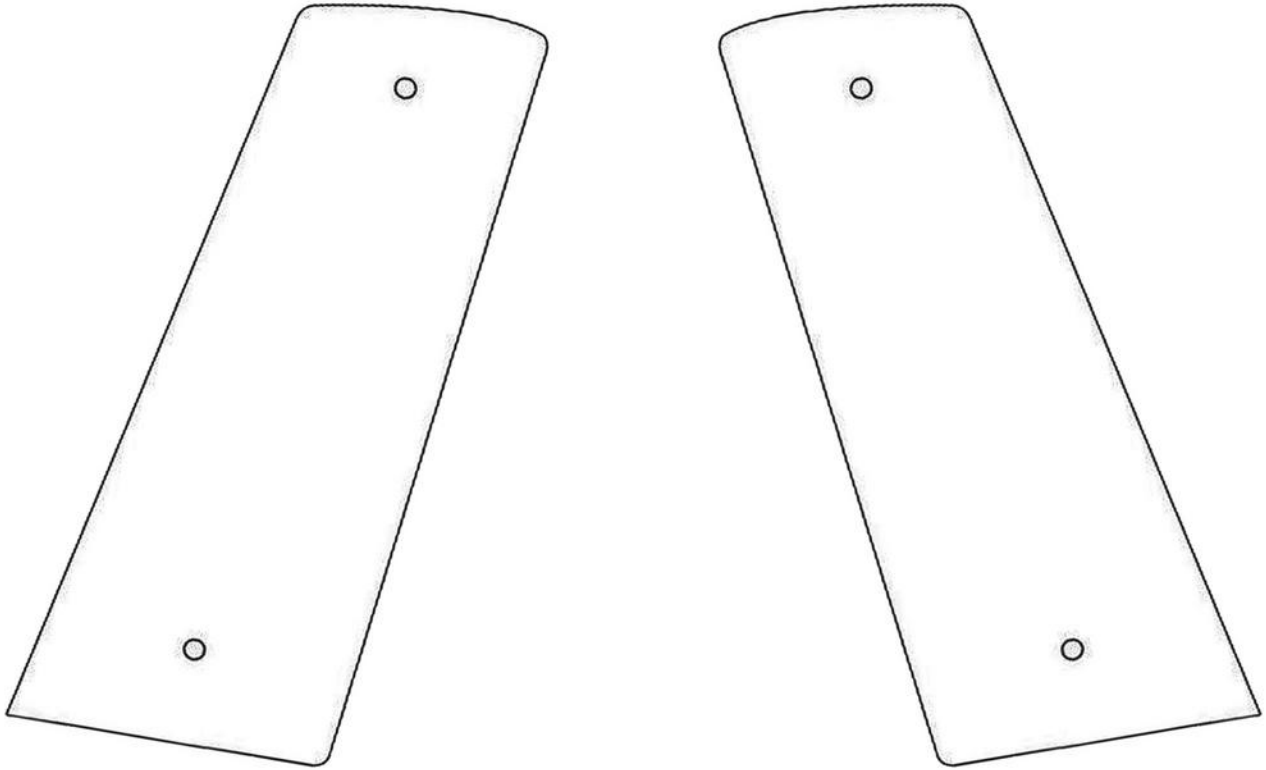

File down surfaces in contact with trigger slot covers to ensure flush fit against frame

*Alternatively fit standard 1911 grip panels*

2 inches

Print on 8.5x11 US letter paper

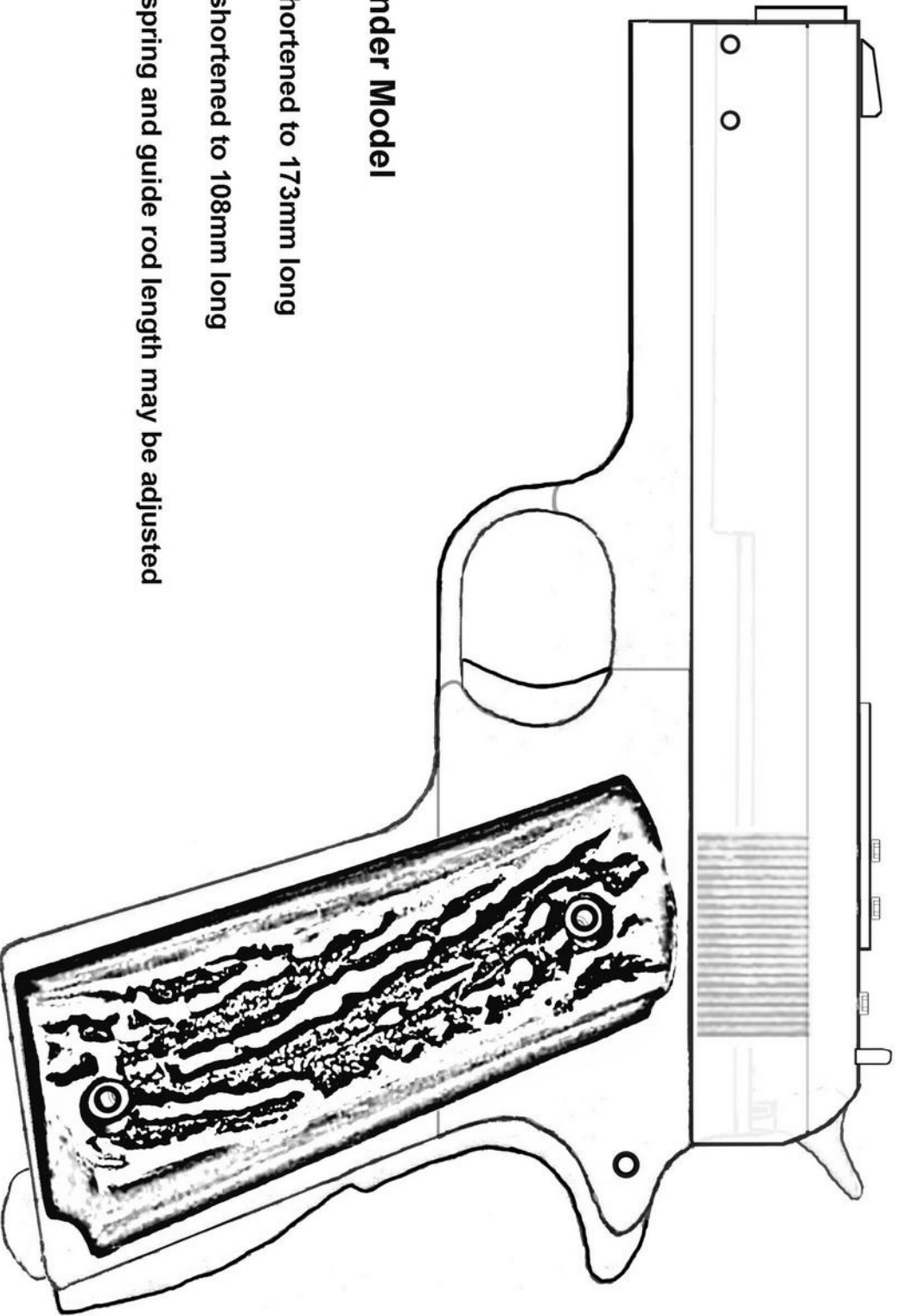

### **Commander Model**

- Slide shortened to 173mm long
- Barrel shortened to 108mm long
- Recoil spring and guide rod length may be adjusted

**2 inches**



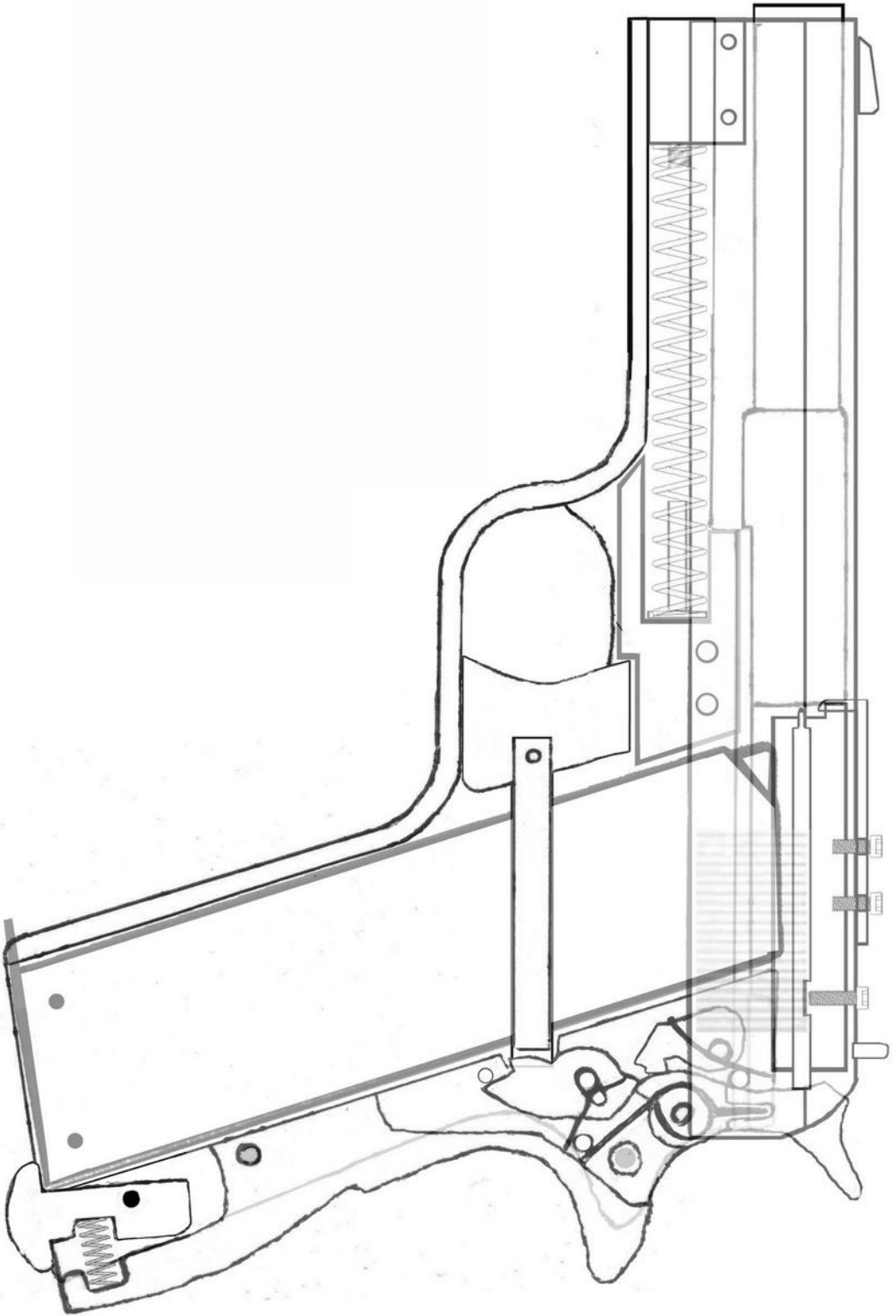

2 inches

Print on 8.5x11 US letter paper

