

The FSB Badger Gun

(.22 Rimfire)

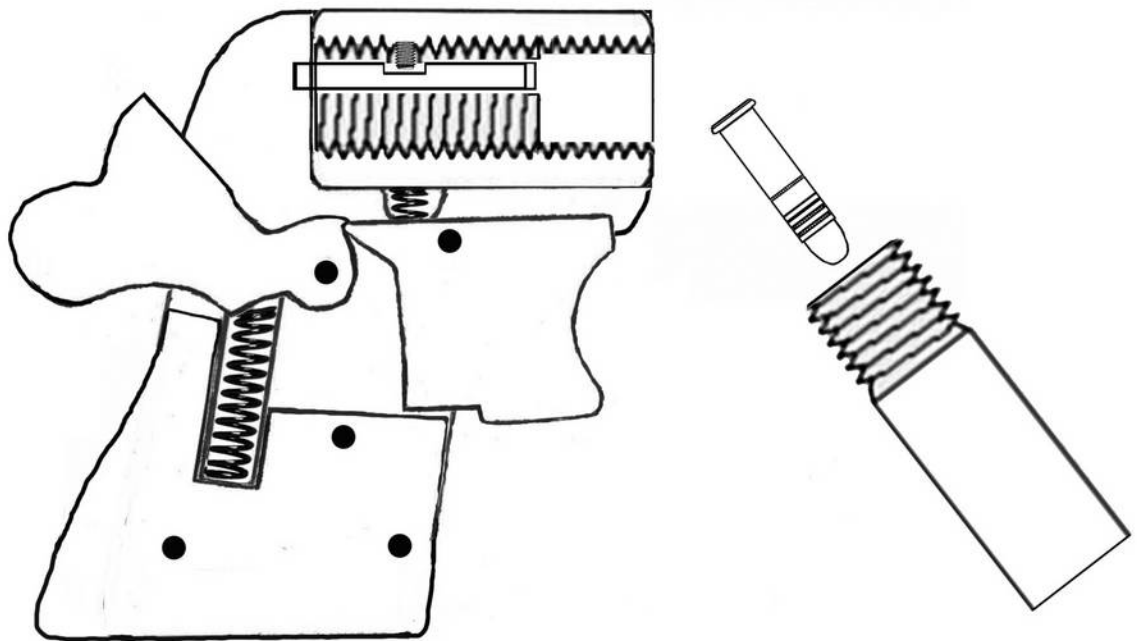

Modify an 85mm long M16 bolt by removing its head.
Reserve 50mm neck portion for barrel.

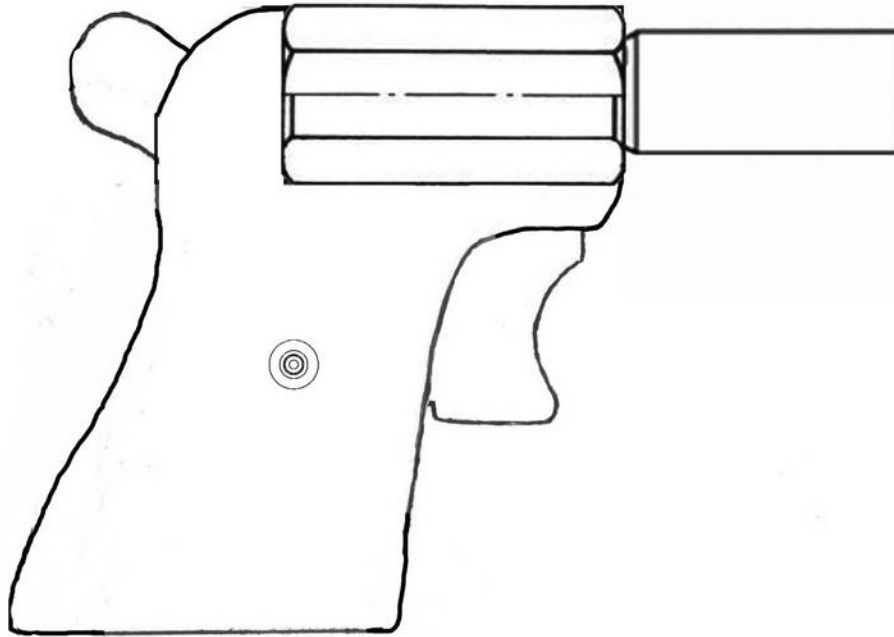
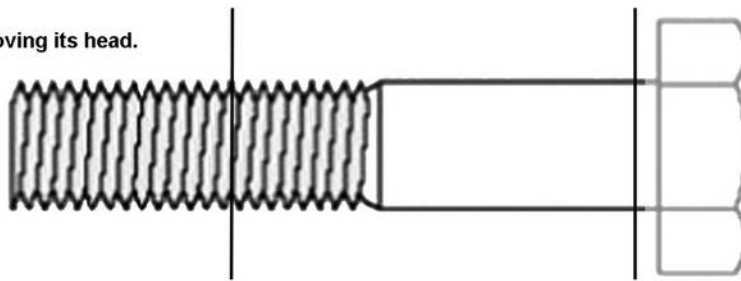

Select mild steel / zinc plated bolts for ease of drilling.

Alternatively a length of studding can be used.

Drill through with a 5mm bit, off-center

Drill and tap a hole for an m4 grub screw

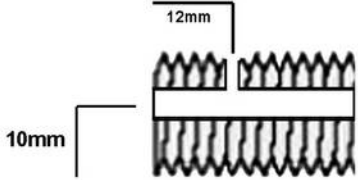

M16 studding connector nut
(Weld to frame)

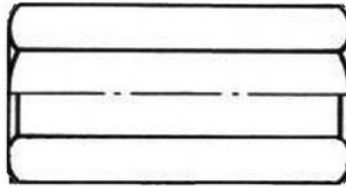

Drill through center with a 5.6mm (7/32") bit

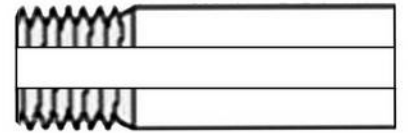

Firing pin

Modified from a 35mm long M5 bolt - file slot in middle

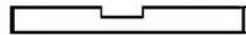

Form front into chisel point

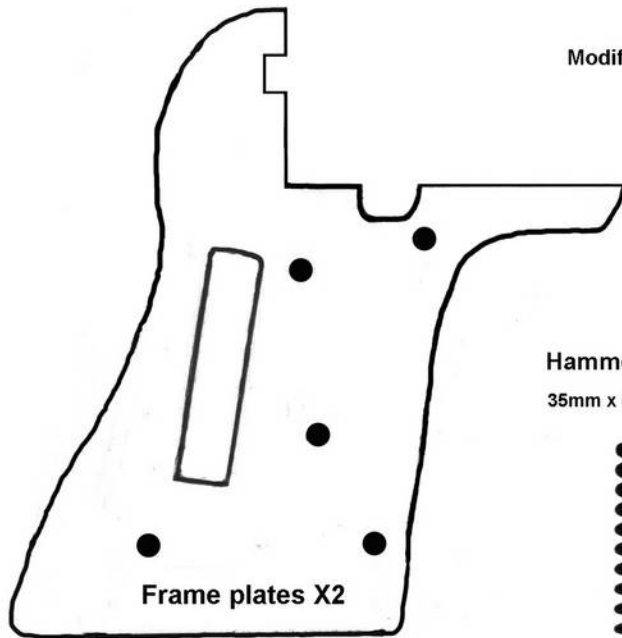

Frame plates X2

Hammer spring
35mm x 5mm x 2mm



Trigger spring
(Off-cut)

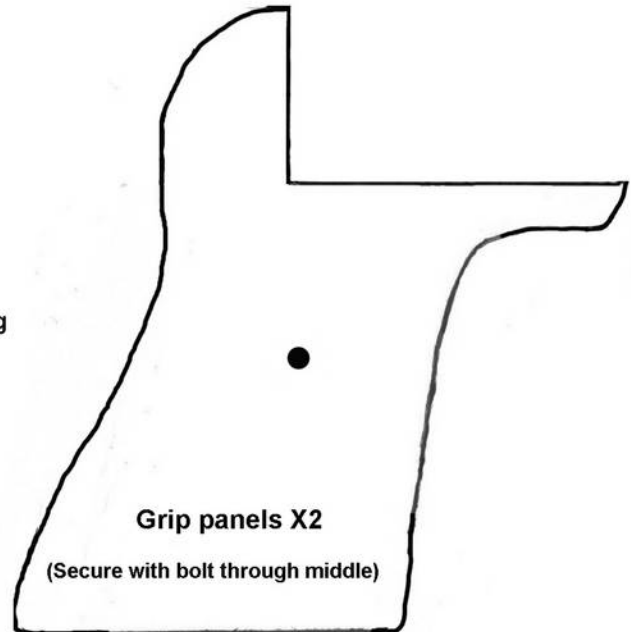

Grip panels X2

(Secure with bolt through middle)

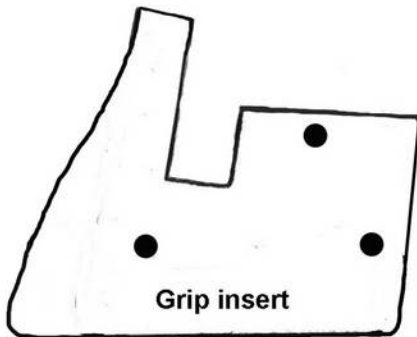

Grip insert



Secure trigger group with M4 bolts or pins

(Spot weld through holes or secure to frame with pins)

2 inches

Print on 8.5x11 US letter paper

Cut all pieces from 3mm or 4mm thick mild steel sheet

.38 / 9x19 version

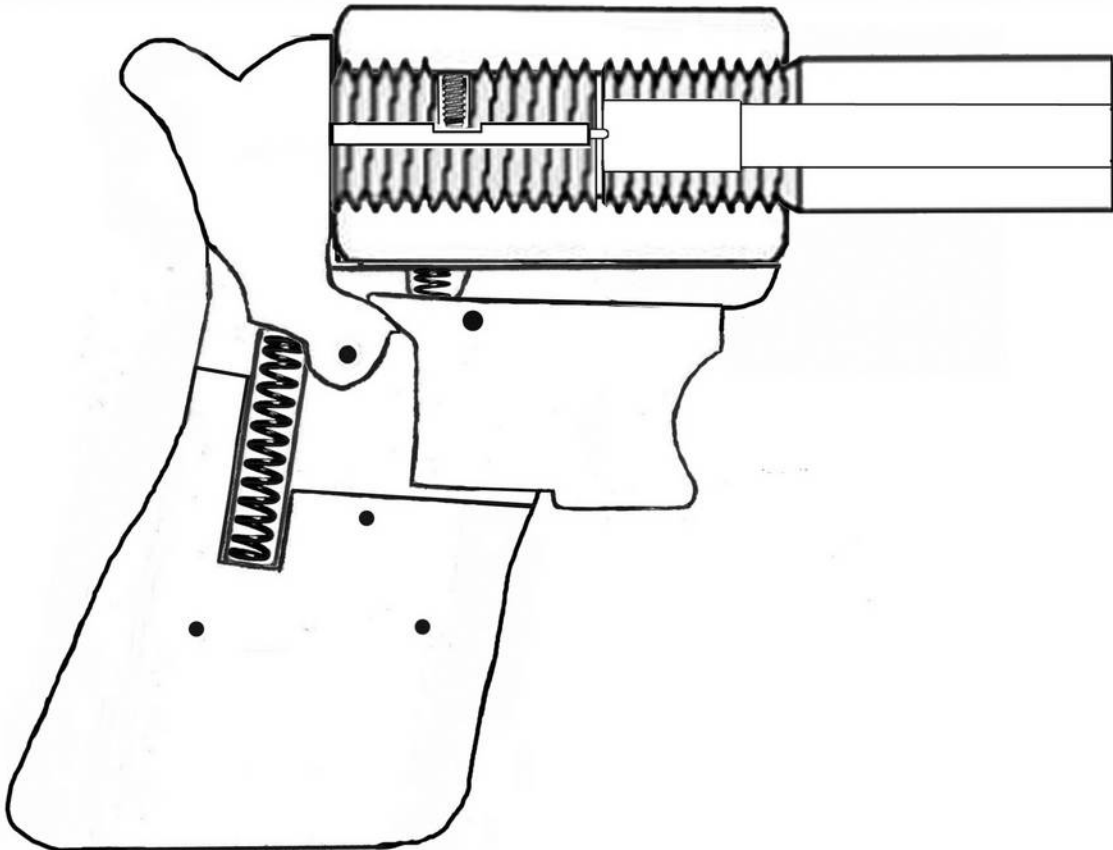
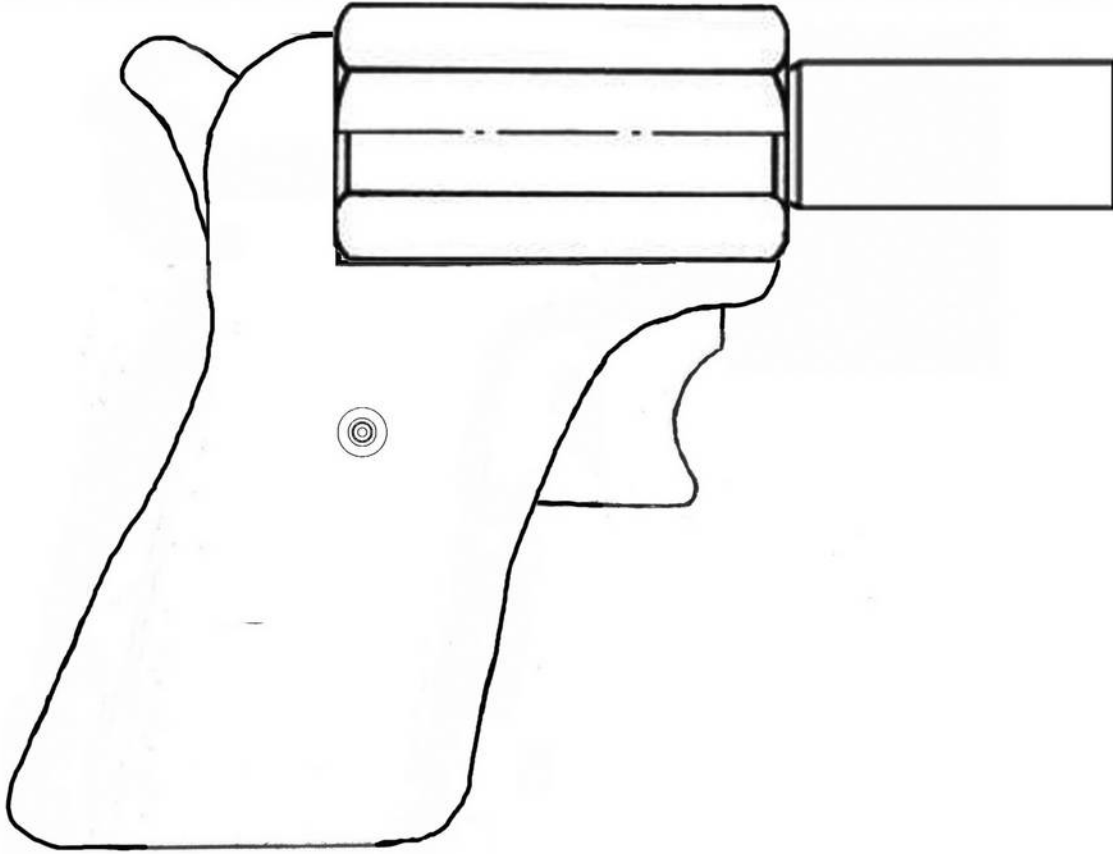

An M20 bolt and studding connector are used to construct the barrel and breech assembly. The firing pin channel is drilled in the center.

Firing pin

Modified from a 38mm long m4 bolt or bar

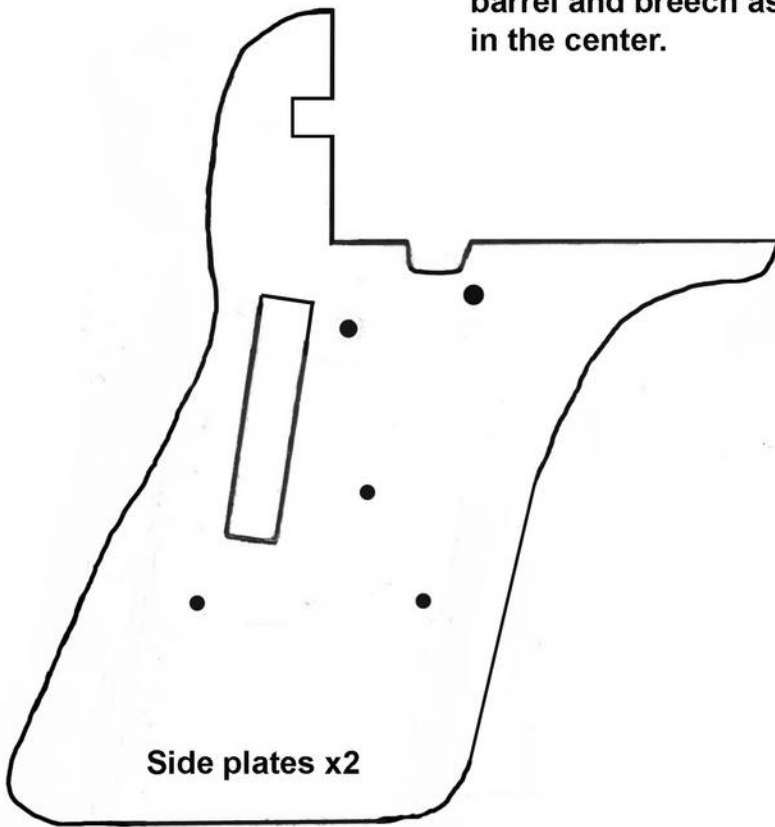

Side plates x2

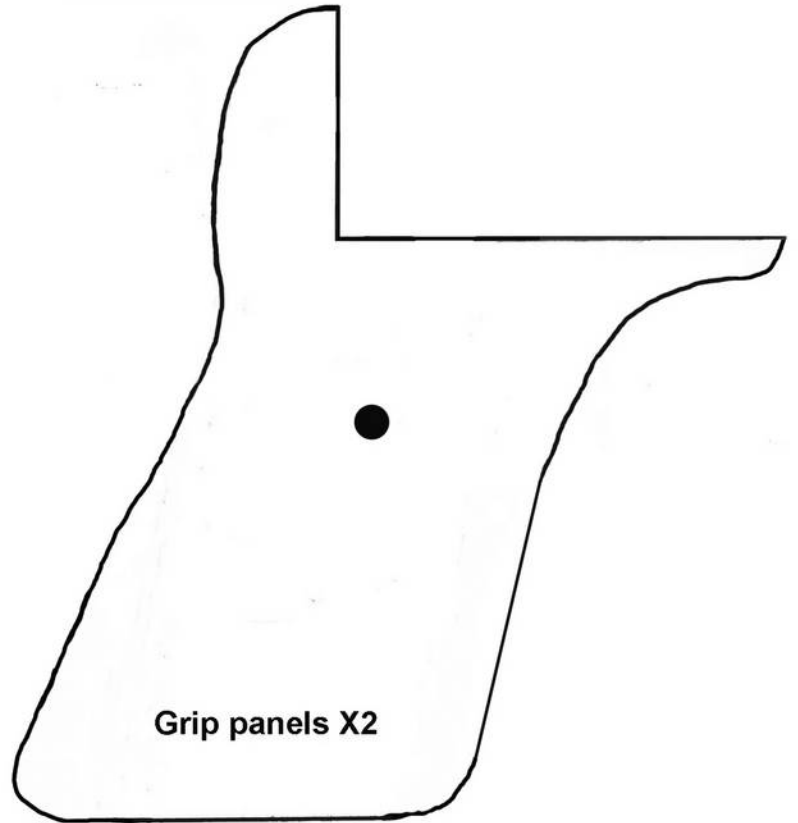

Grip panels X2

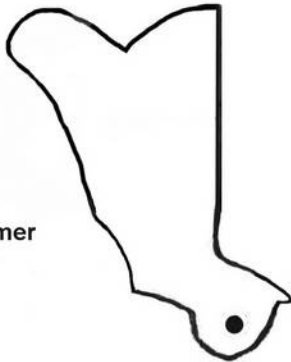

Hammer

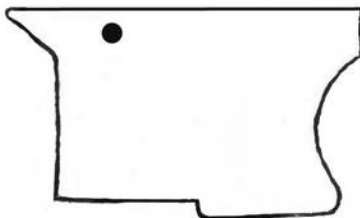

Trigger

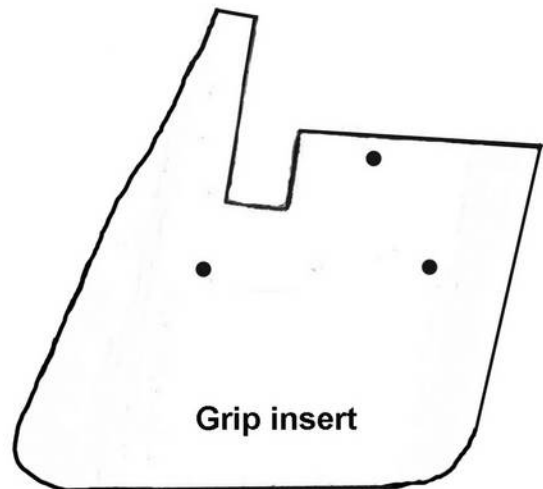

Grip insert

2 inches

Print on 8.5x11 US letter paper

Cut all pieces from 3mm or 4mm thick mild steel sheet

Firearms constructed using an identical nut & bolt barrel assembly

(Not the author's)



Pic1: The gun disassembled. Note the .22 round for size comparison.

Pic2: The hole for the striker is off-center because the .22LR is a rimfire cartridge.



Pic3: The gun with the striker cocked, the threading on the bolt acts as sear. Pushing the bolt down will make it fall and the rubber band will fling it against the primer. Using a file to make a larger sear is possible.



Pic4: The gun after firing/the striker down. Carrying the gun loose in a pocket in this manner is not a good idea as a bump against the striker means trouble.

However with some practise, one can cock the striker with one hand, without looking. With a barrel this short special care must be taken, though.

Pic5: The striker assembly. A piece of bicycle tire makes for an excellent spring. One washer has a notch to help the rubber band orient itself. Note that the band has ruptured after heavy use (100 shots), replacing it takes less than half a minute.



Pic6: With the striker down, the gun fits inside the fist of an adult man. Yet out of the 50mm barrel the .22LR is still deadly at close range



“

It ain't pretty but it doesn't have to be. The overall cost will stay around 10€/14\$ if you buy all the parts. But most of the parts can be scavenged from junk yards so you may end up with a free 9x19 handgun.

I drilled the barrel for a 9x19 using a 9mm bit and a 10mm bit for the chamber (a chamber reamer is recommended!) but you can chamber the gun for .38spl or even for .357mag if you are feeling lucky. I have found out that a barrel made out of an M20 bolt can take several hundreds of .357mag but it really is pushing the steel to its limits.

You should always remember that none of these parts were designed for this and an air cavity inside the steel may rupture the barrel or then after enough stress the steel may just give up. Using eye protection is an absolute must when using guns such as this.

That being said this gun can be amazingly durable when constructed properly. Especially with a properly sized striker (this is important!) and low pressure loads no problems *should* appear. Still, as always, you should test fire the gun extensively with high pressure loads before even thinking about firing it from hand. The steel isn't heat treated and wasn't meant to be used in a gun so after some time the barrel may fail under stress.

This is why I recommend you use mild loads. You can swap the caliber simply by switching the barrel and I would recommend shooting only low pressure 9x19 or .38spl and testing the barrel with high-pressure stuff (+P 9x19 or .357).

I have personally put hundreds of rounds through barrels made out of bolts and never have I had a failure. Now this doesn't mean they are optimal but the sure can take a beating. As you can see from the picture above M20 is a thick bolt and there's 5,5mm of steel around the bore and 5mm around the chamber (+the long nut is over the chamber making it even stronger). ”

