

# DIY .22 Revolver

## Construction Plans

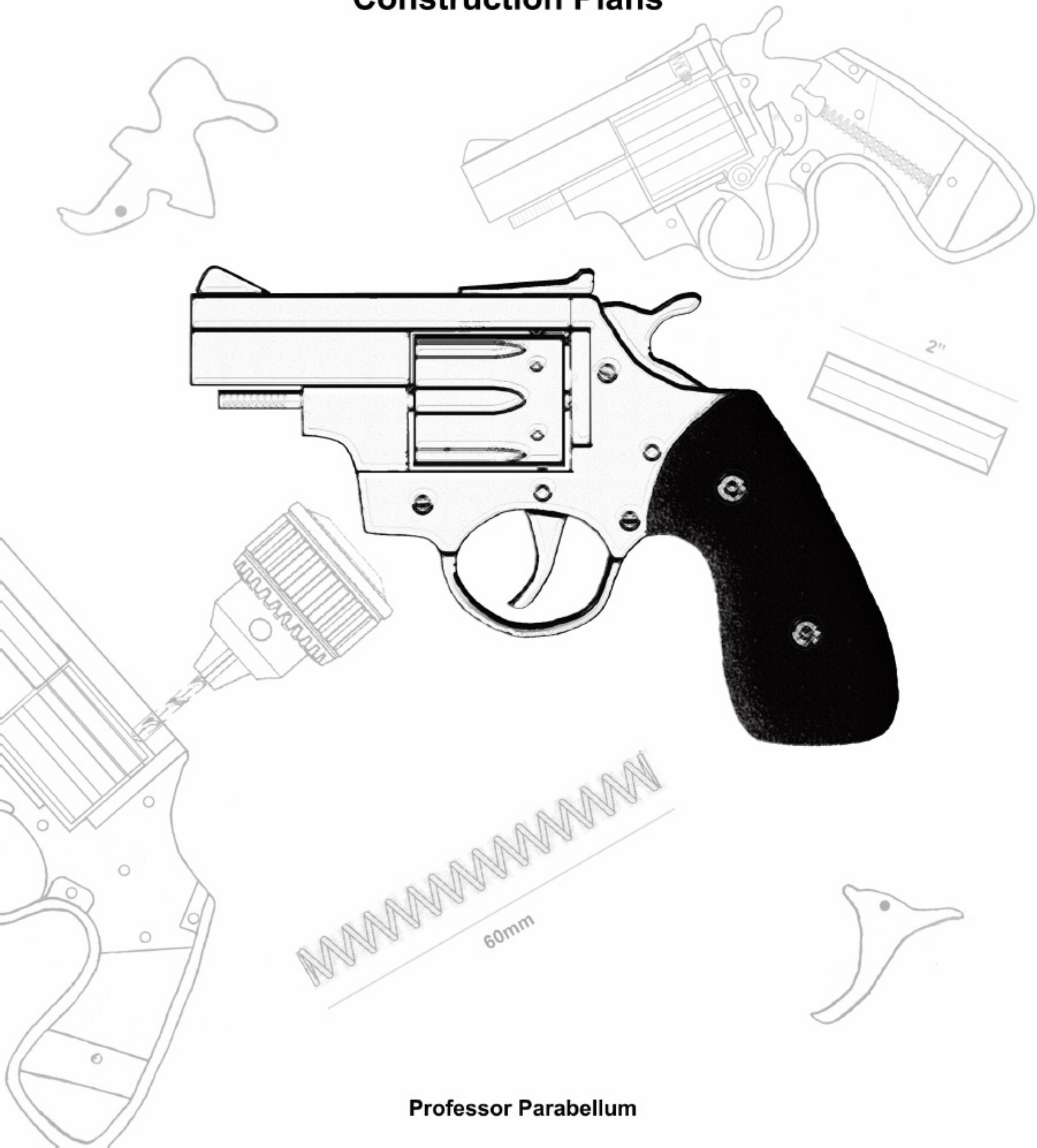

Professor Parabellum



The following drawings are reverse engineered from images of a revolver made by an unknown gunsmith in Russia. The design is both double and single action with a manually turned six shot cylinder which is indexed with the aid of a spring loaded detent. A removable pin held in place via friction allows the cylinder to be removed for loading and also doubles as a cartridge extraction rod when unloading. Only basic hand tools and a welder are required for construction of the gun, which uses steel plate and round bar stock for the majority of its components.



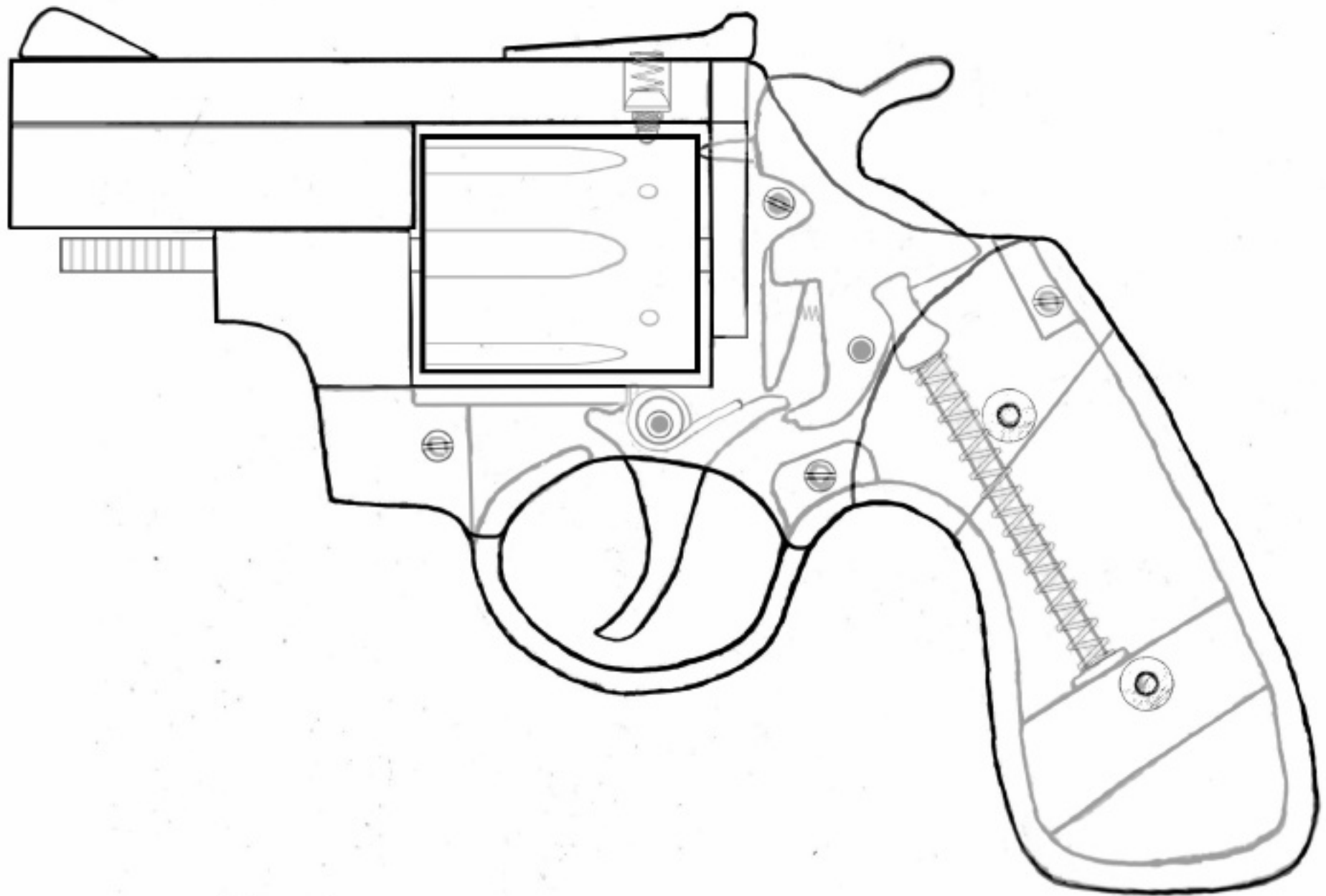

All pages included should be printed out on 8.5 x 11 US letter paper. Each component template is drawn to scale and can be cut out and glued to their respective thickness of material or used as a reference for measurements. Make sure the ruler at the bottom left of each sheet is 2 inches in length. Alternatively, take a screen-shot and enlarge the plans using a computer program until the ruler is the correct length, then trace the parts needed onto a sheet of paper taped over your computer's screen.

# Frame

Bend to profile from a 12" long strip of 3mm thick, 8mm wide mild steel strap.

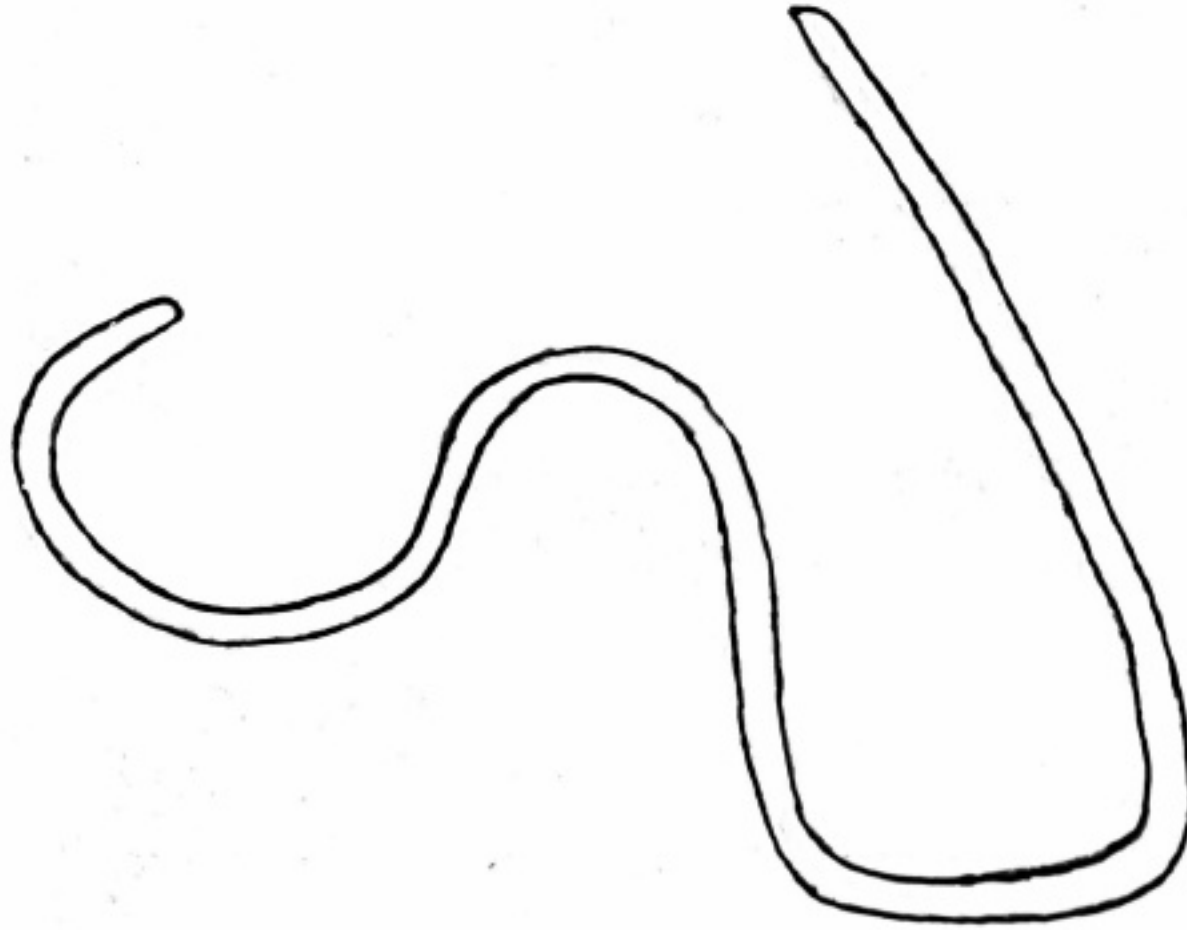

Cut out two pieces of 8mm thick steel plate and weld in the positions shown.

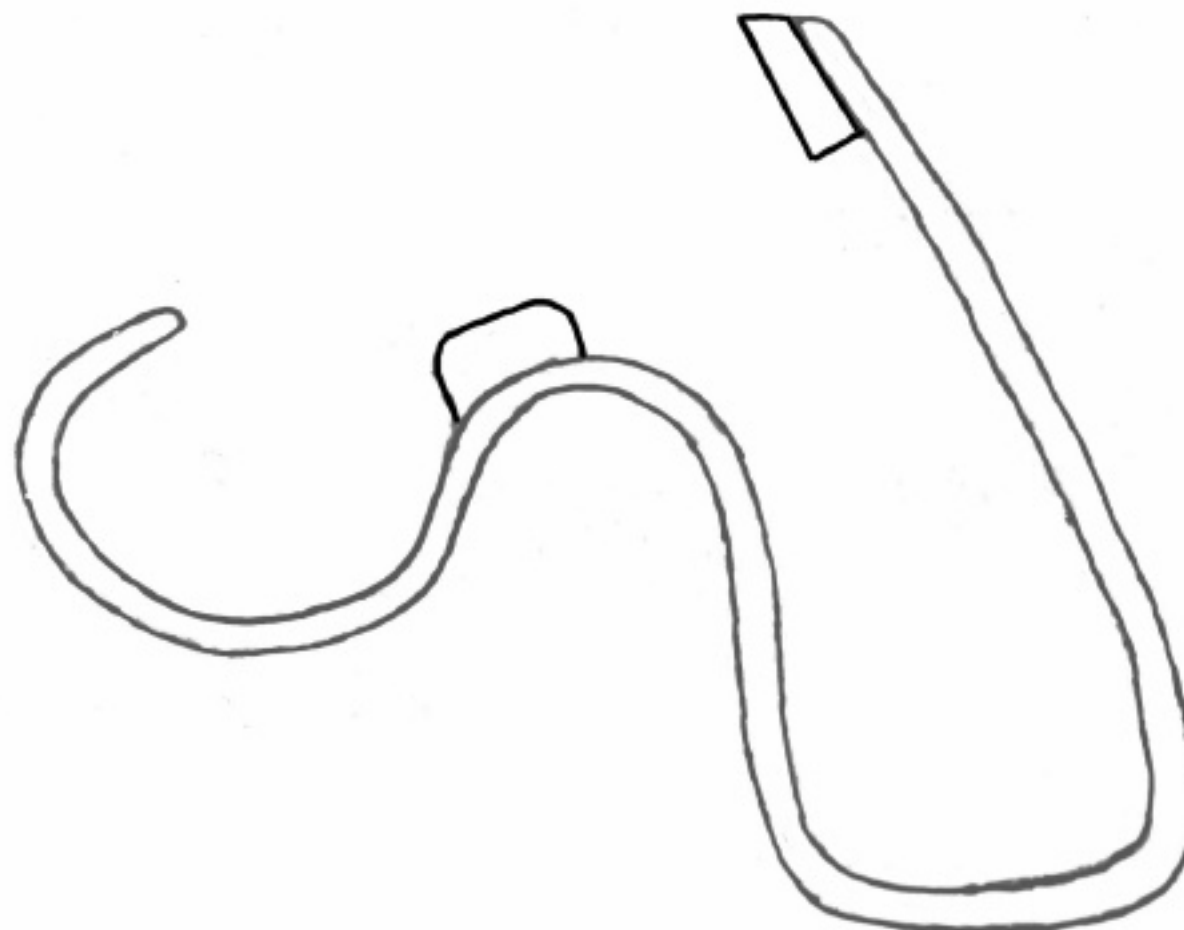
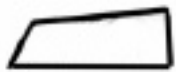

2 inches

Print on 8.5x11 US letter paper

# Frame side plates

Cut from 2mm thick mild steel sheet

*Right side:*

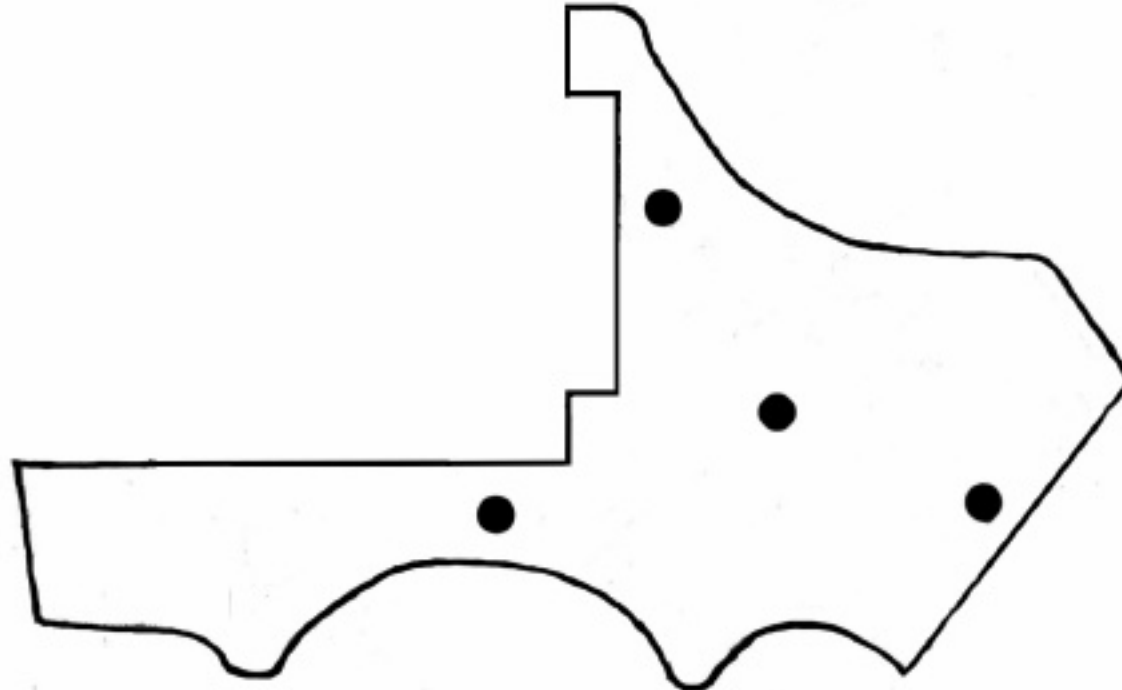

*Left side (cover):*

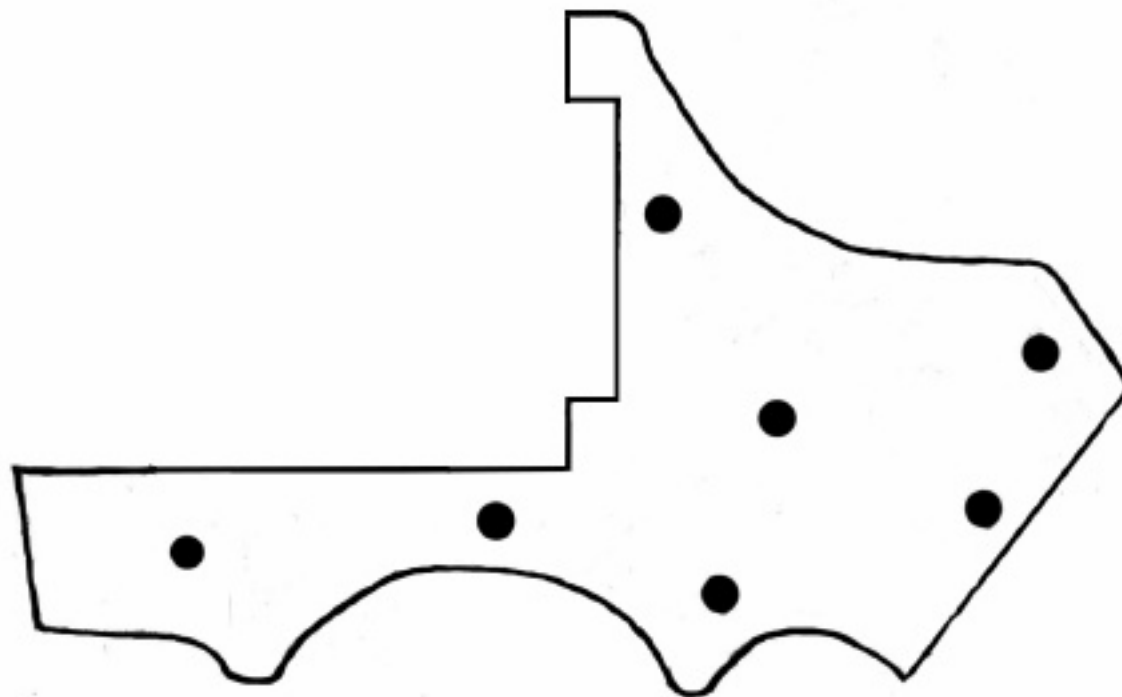

2 inches

---

Print on 8.5x11 US letter paper

## Hammer and trigger posts

*Right side plate*

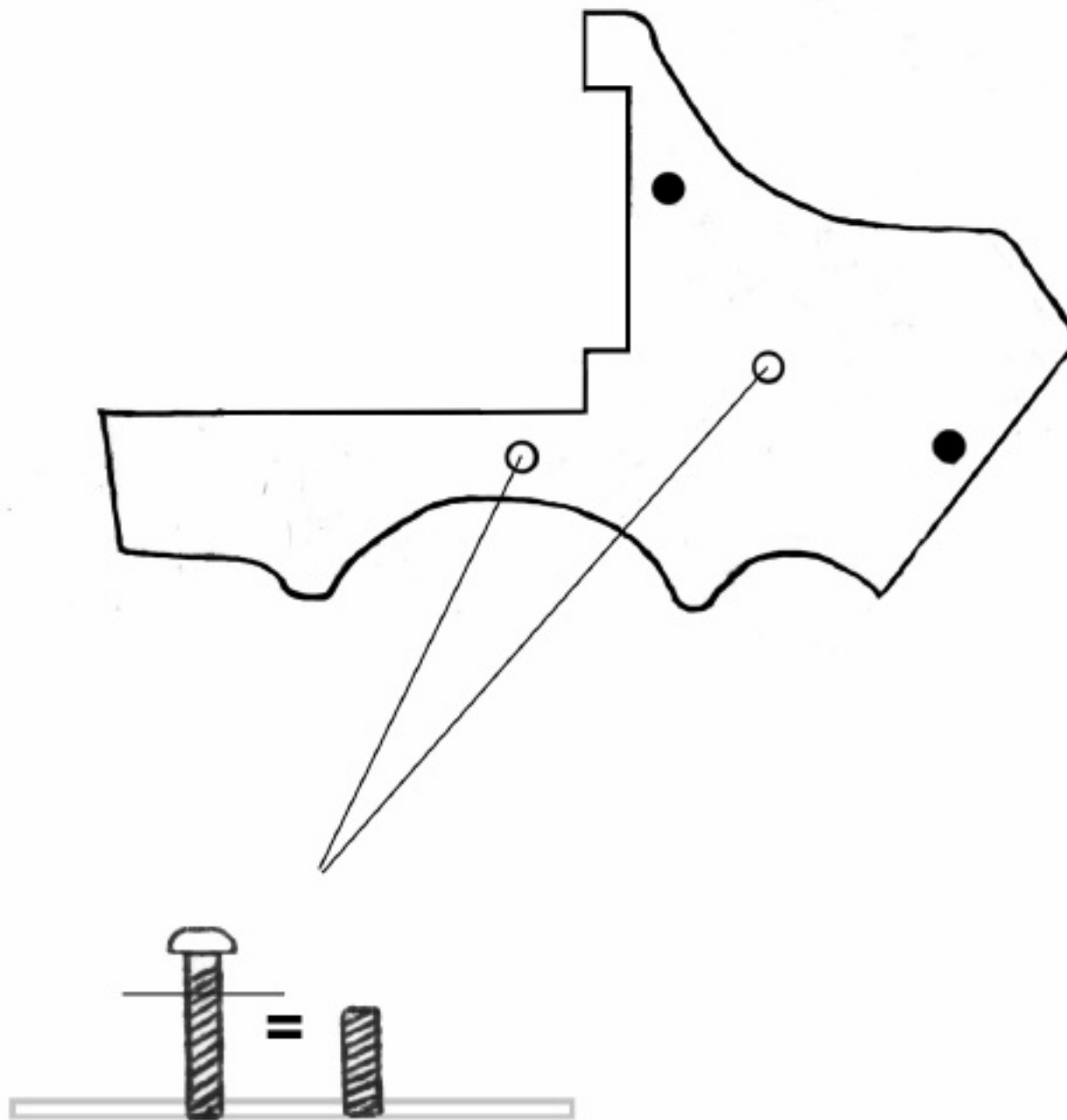

The hammer and trigger post holes are both drilled with a 3mm bit and tapped to accept an m4 bolt with epoxy applied to the threads. Each bolt is then beheaded to create two 10mm high fixed pivot posts. Alternatively use two 12mm long 4mm dia pins and weld over bottoms from right side.

# Hammer

Cut from 8mm thick steel plate.

Hole: 4mm



## Double action sear (Optional)

8mm steel plate

File down top width to 4mm



Drill shallow 3mm hole for spring seat

Compression spring  
(3mm dia, 8mm long)



Slot hammer with a dremel  
+ disc and pin DA sear in place

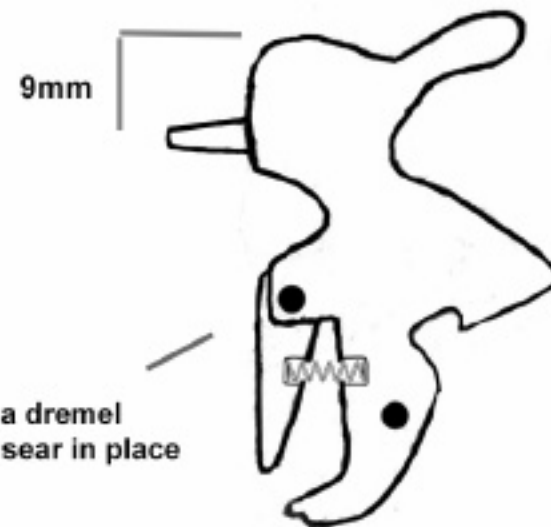

Firing pin hole is drilled 6mm deep to accept a length of 4mm dia drill rod which is epoxied in place. The finished firing pin should protrude 8mm from hammer face. The firing pin is filed down to a chisle edge point.

2 inches

Print on 8.5x11 US letter paper

# Trigger

Cut from 8mm thick steel plate

Hole: 4mm



Use a dremel fitted with a reinforced cutting disc to grind out a pocket for the trigger coil spring to sit, reducing the area surrounding the pin hole to 4mm in thickness.



Trigger coil spring

Can be modified from a washing line peg spring or wound from 19 gauge spring steel music wire.



Bend spring over arm

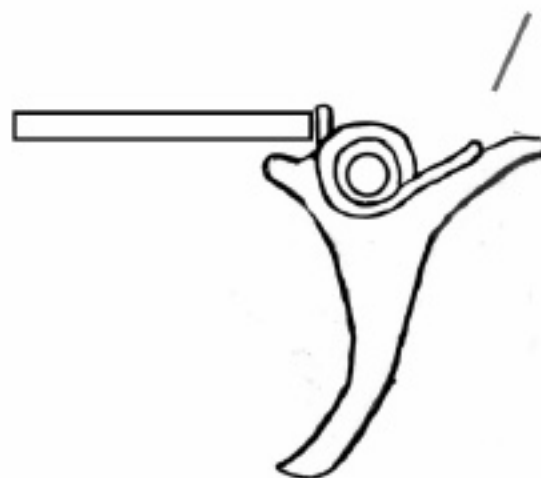

2 inches

Print on 8.5x11 US letter paper



# Barrel

The barrel can be a 2" length of 1/2" (13mm) outside dia seamless steel tube with a wall thickness of 4mm and reamed to size using a 5.6mm drill bit or bored from a solid bar. Alternatively a section of .22 air gun barrel may also be used.



Create a shallow forcing cone bevel using a 12mm dia drill bit at chamber end. Sand and polish smooth.

## Top strap

8mm thick mild steel plate, 88mm long, 8mm wide



Drill through top using a 4mm bit

## Bottom plate



2 inches

# Barrel assembly

Drill though using a 5mm bit for cylinder pin, as close to the top as possible

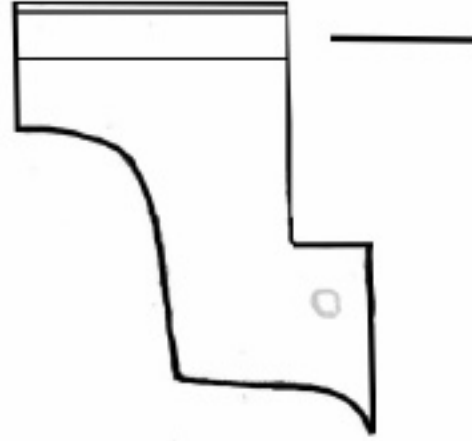

Clamp pieces together and weld a bead along each side. Sand smooth using an angle grinder fitted with a flap disc.

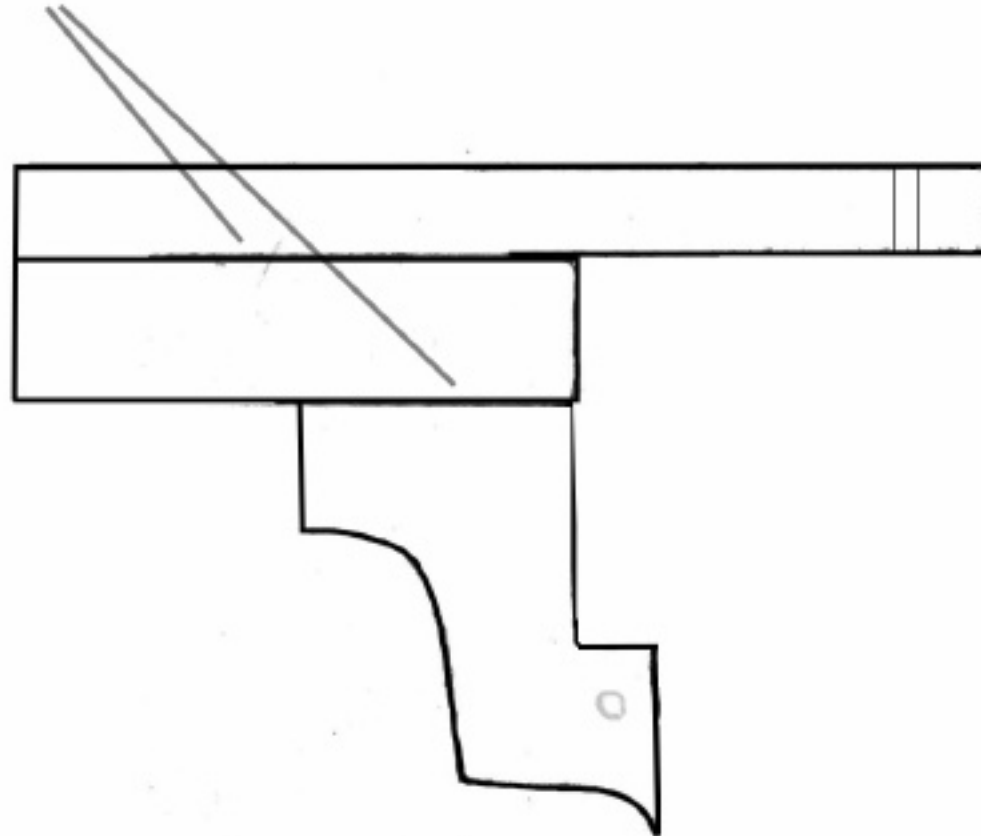

2 inches

# Breech plate

Cut from 5mm thick mild steel plate.

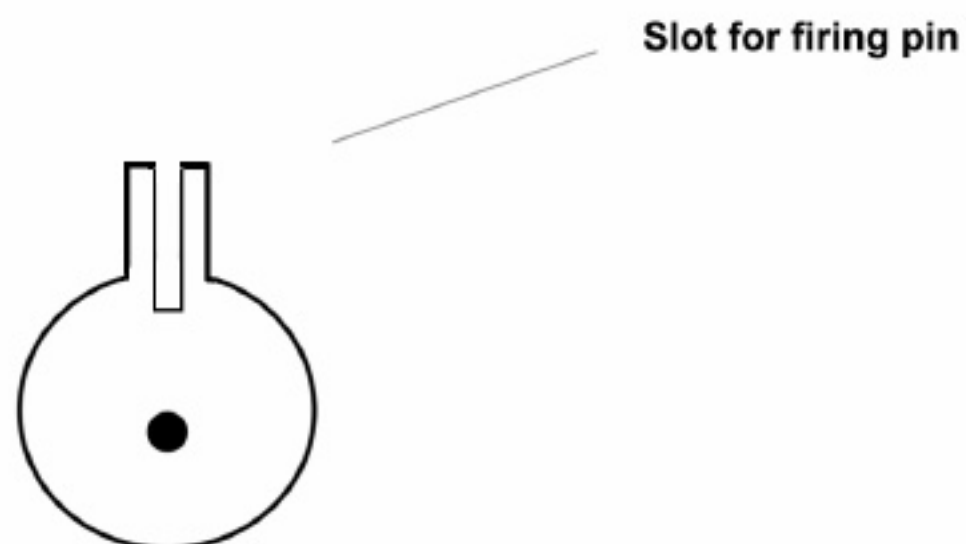

Drill cylinder pin retaining hole 5mm dia, 4mm deep.

## Cylinder pin

5mm dia steel round bar.



2 inches

Print on 8.5x11 US letter paper

# Frame assembled

Align left side plate with frame and drill screw holes.  
Tap for four m4 counter-sunk bolts.

Weld breech plate to top strap and right side frame plate.

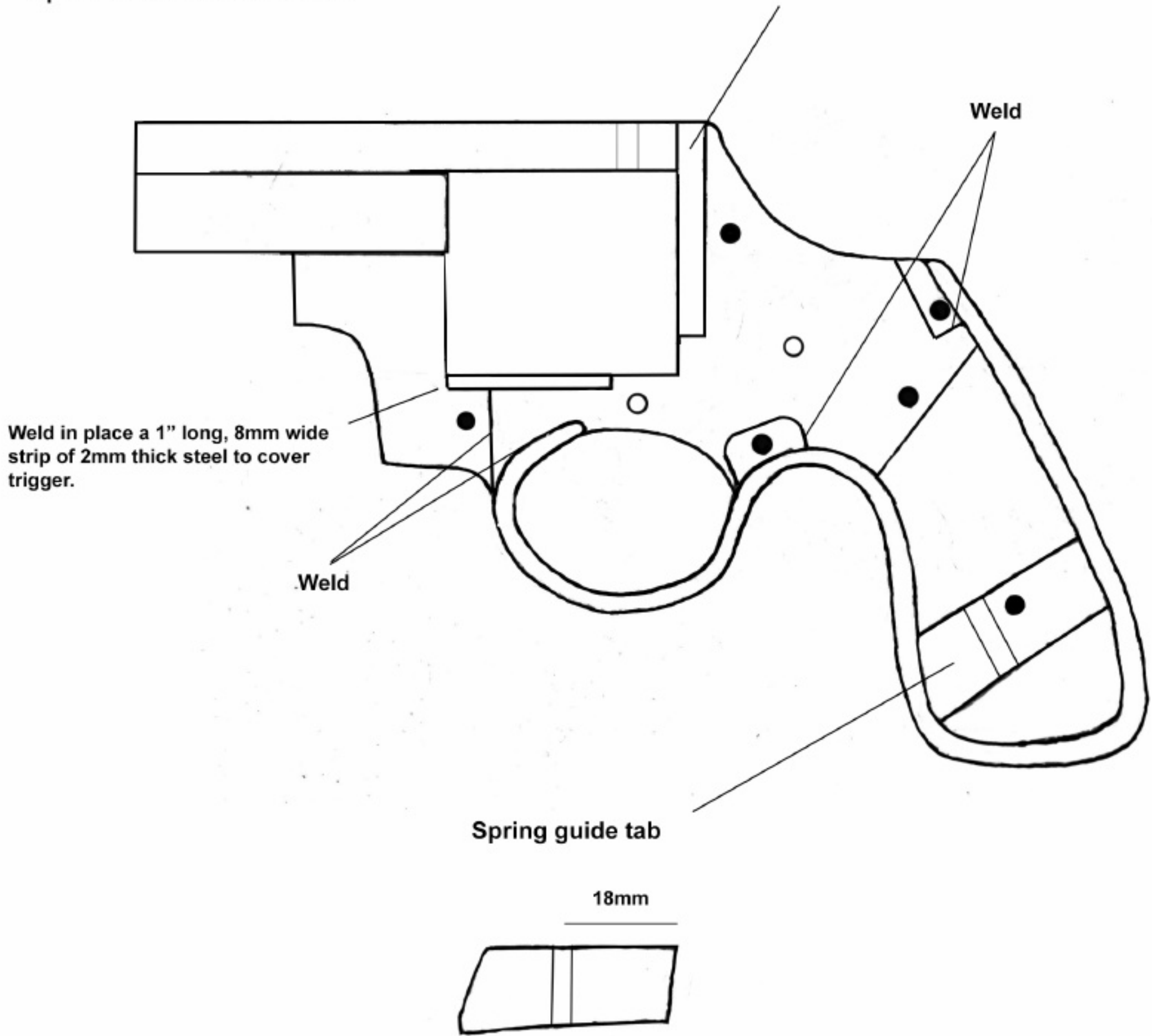

Weld in place a 1" long, 8mm wide strip of 2mm thick steel to cover trigger.

Cut from 8mm thick steel plate. Drill through with a 4mm bit for spring guide rod.  
Weld in position shown.

2 inches

Print on 8.5x11 US letter paper

# Guide rod and main spring

Cut from 8mm thick mild steel plate.



4mm dia steel bar, 55mm long.



Drill a hole using a 4mm bit and epoxy guide rod in place

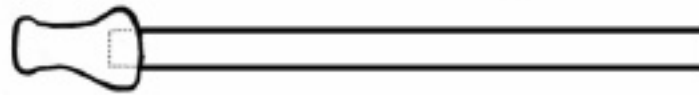

## Main spring

5mm ID, 60mm long. 1.5mm wire.



60mm

# Cylinder

30mm dia steel round bar, 35mm long

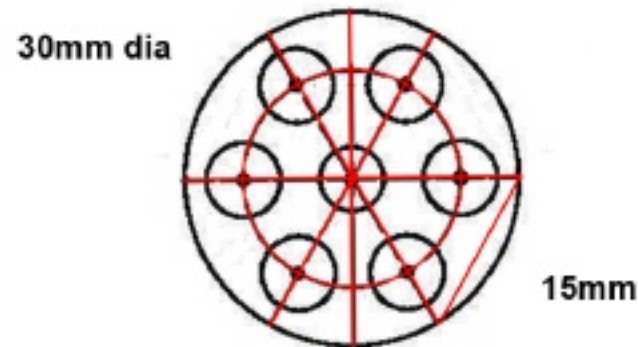
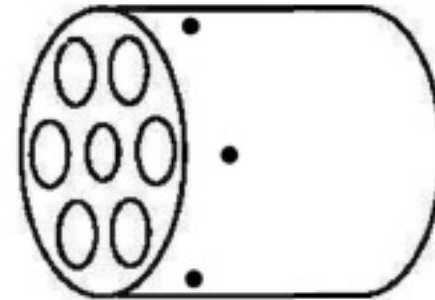
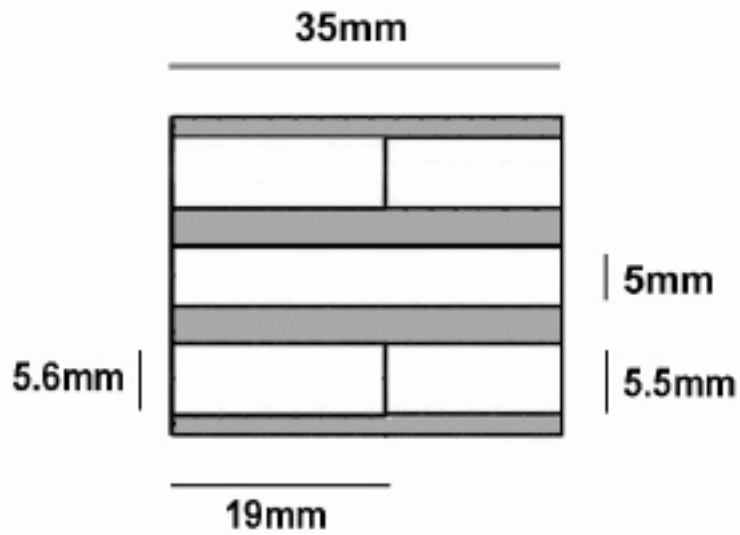

- Scribe two lines forming a cross to locate center.
- Following a clockwise pattern from the point on the right outer edge, mark 15mm to an adjacent point and scribe another line to the center.
- Set a compass to 10mm from the center and scribe 20mm dia inner circle to locate the positions of each chamber hole.
- Each chamber hole is drilled using a 5.5mm bit and chamfered 19mm deep using a 5.6mm bit.
- Drill through center using a 5mm drill bit for cylinder pin.

*Scallops can optionally be cut in between each chamber on the outside wall of the cylinder by using a dremel fitted with a rounded tipped grinding bit.*

2 inches

## Aligning the cylinder

Insert a 5" length of 5.5mm dia bar through barrel and into a chamber in the cylinder. Using the detent hole in the top frame strap as a guide, lower a 4mm drill bit through it and drill a shallow dent into the position (now locked) on the cylinder wall. Repeat the process for each of the six chambers. If completed correctly, the spring loaded detent will produce a ratcheting friction lock when the cylinder is turned. The hole is enlarged in diameter using an 5mm bit for a depth of 5mm to accommodate detent and spring.

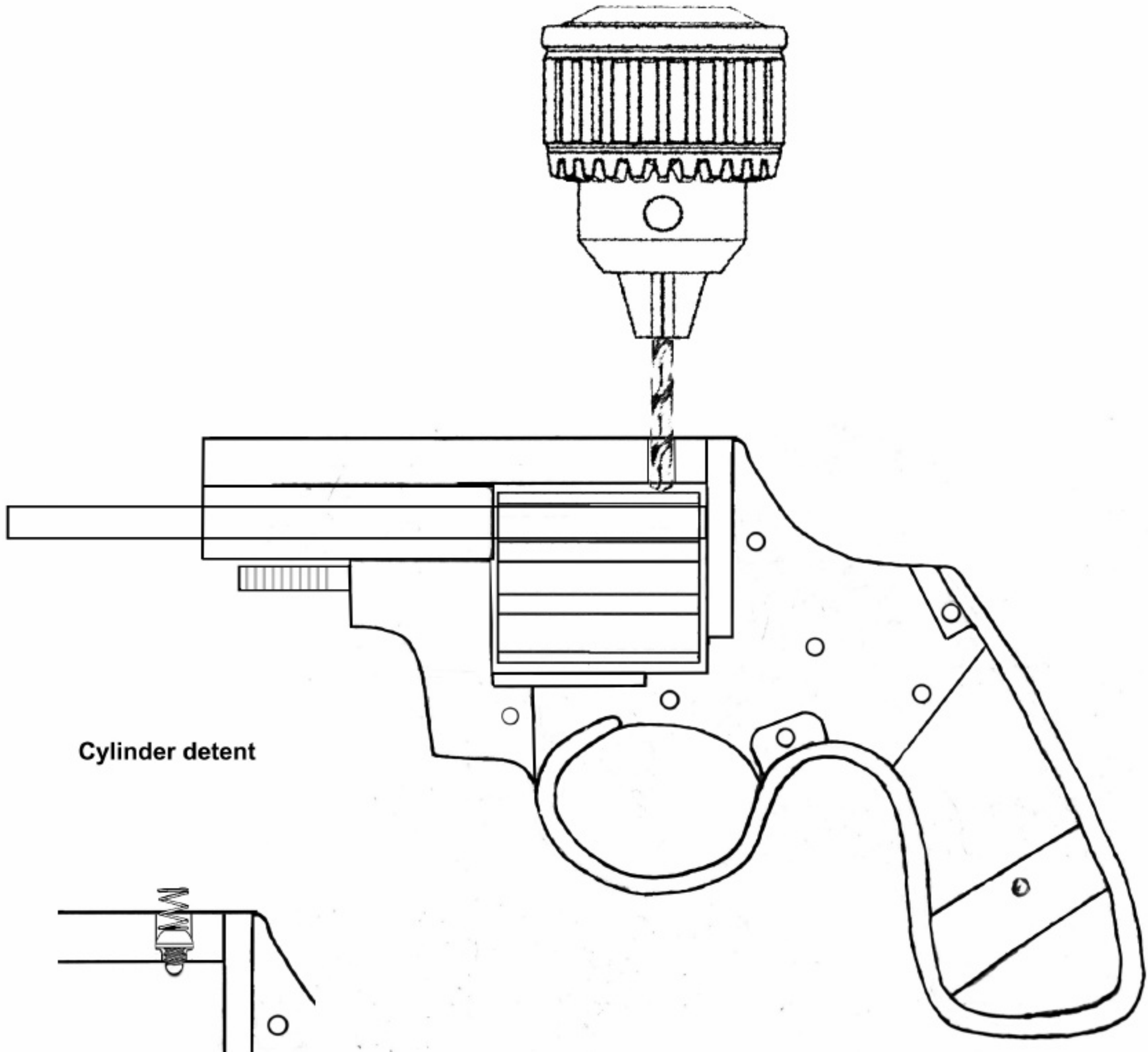

A 5mm long m4 bolt is modified by rounding off its tip and reducing the diameter of its head. A 5mm OD compression spring is inserted behind the bolt and retained by the rear sight.

# Sights

## Front

Cut from 4mm thick mild steel plate. Weld in place.

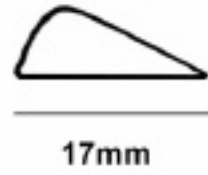

## Rear

Cut from 8mm thick mild steel plate

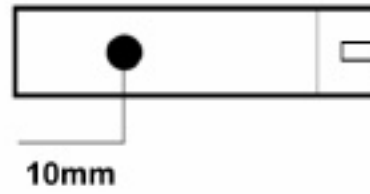
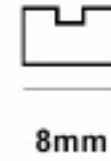
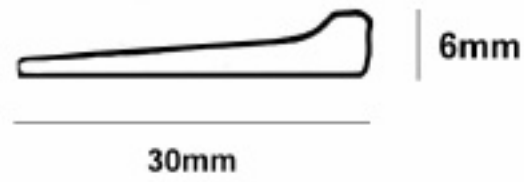

Retain to top strap using a counter-sunk m5 bolt.

2 inches

Print on 8.5x11 US letter paper



# Grips

Cut from 1/2" thick plastic or hardwood.

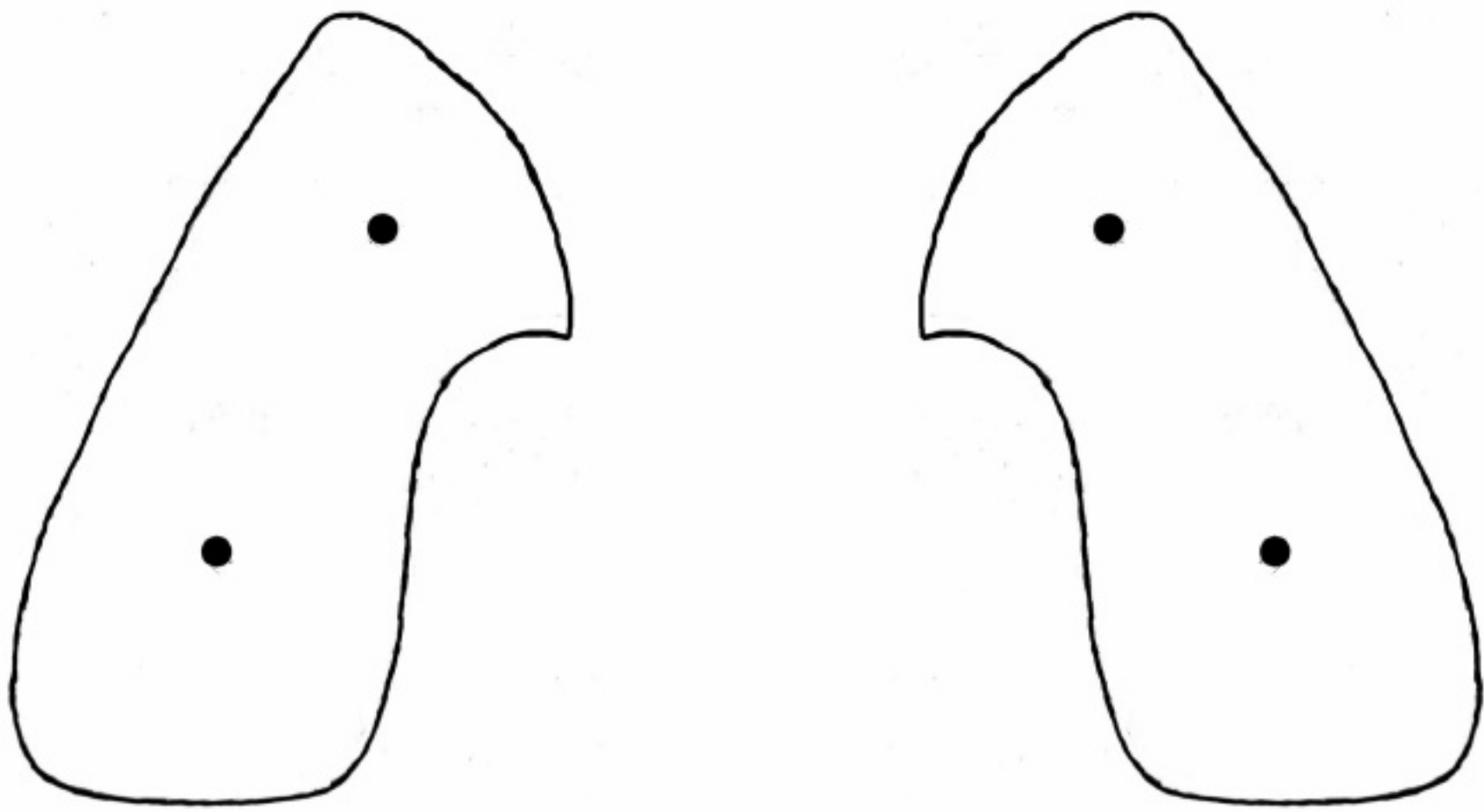

Epoxy a nut into each hole on left grip panel and retain using two m5 button head bolts, 1 1/12" long.

2 inches

---

Print on 8.5x11 US letter paper

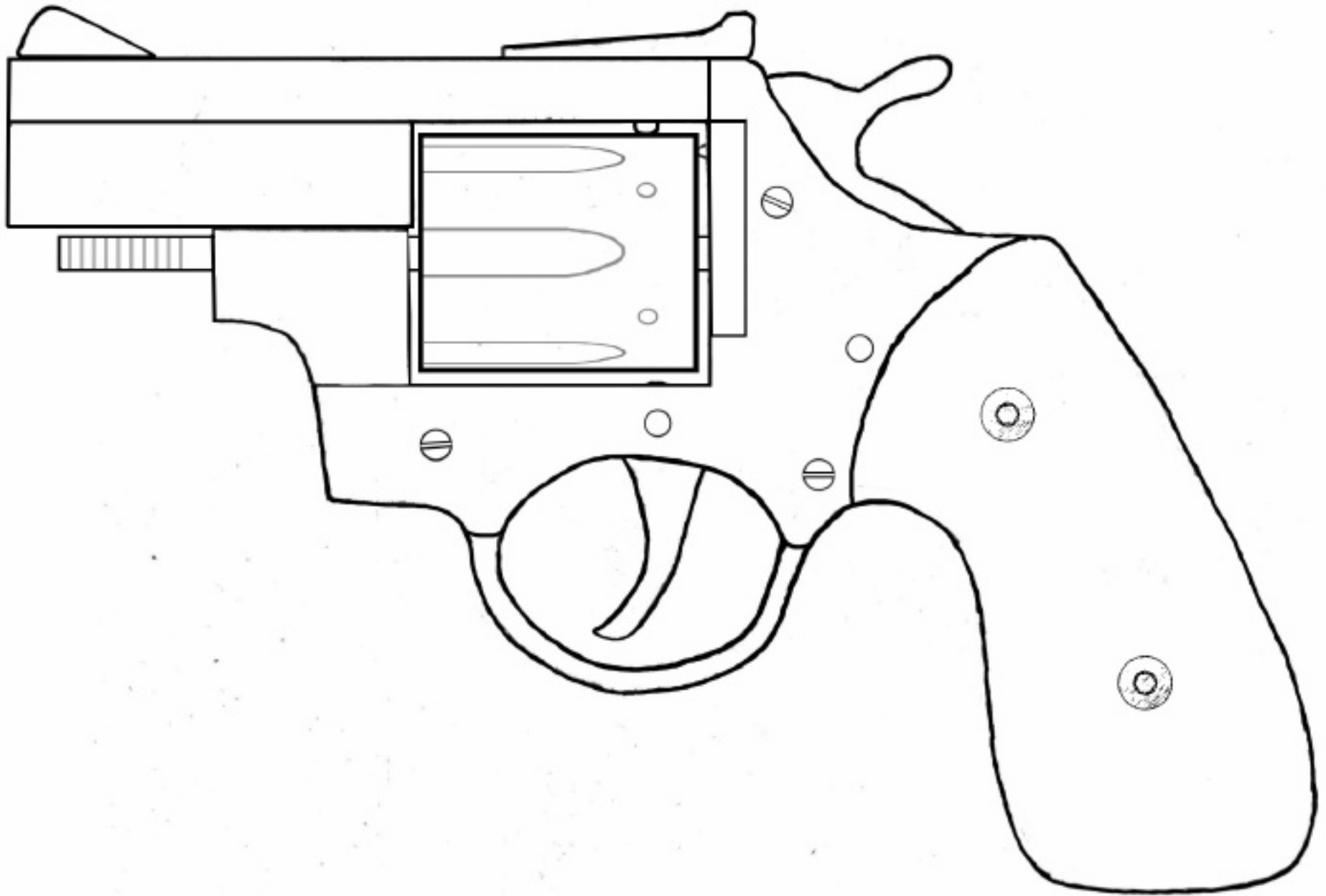

2 inches

Print on 8.5x11 US letter paper

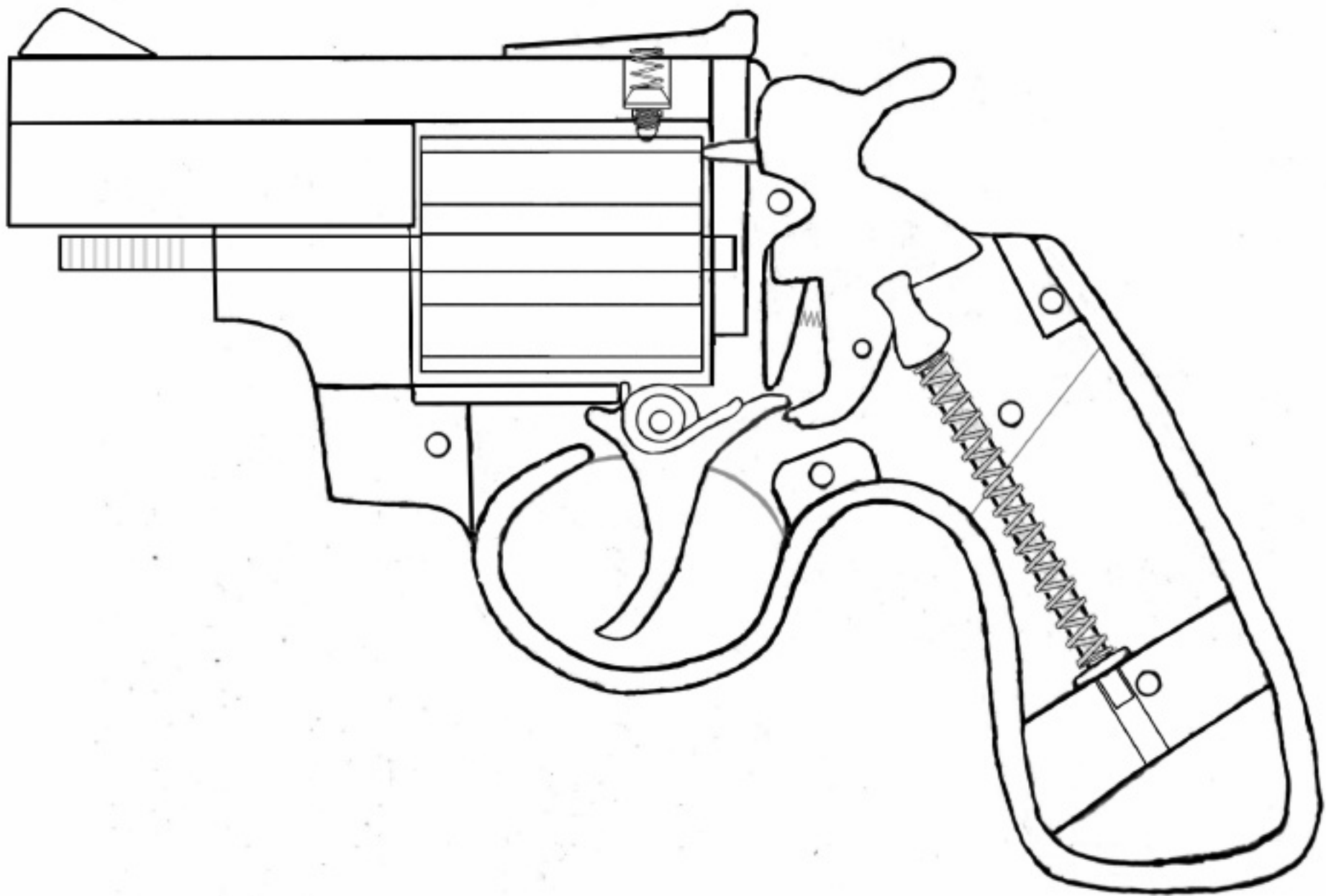

2 inches

---

Print on 8.5x11 US letter paper

