

**CHALLENGE TO APOLLO:
THE SOVIET UNION AND THE
SPACE RACE, 1945-1974**

NASA SP-2000-4408

**CHALLENGE TO APOLLO:
THE SOVIET UNION AND THE
SPACE RACE, 1945-1974**

by

Asif A. Siddiqi



National Aeronautics and Space Administration
NASA History Division
Office of Policy and Plans
Washington, DC

2000

Library of Congress Cataloguing-in-Publication Data

Siddiqi, Asif A., 1966-
Challenge to Apollo: the Soviet Union and the space race, 1945-1974 / by Asif A. Siddiqi
p. cm —(The NASA history series) NASA SP ; 2000-4408

Includes bibliographical references and index.

I. Astronautics—Soviet Union—History. 2. Space race—History. I. Title. II. Series. III.
NASA SP ; 4408.

TL789.8S65 S47 2000
629.4'0947—dc21

00-038684 00031047

*To my mother and my father,
who taught me the value of knowledge*

History is always written wrong, and so always needs to be rewritten.

—*George Santayana*

You can't cross the sea merely by standing and staring at the water.

—*Rabindranath Tagore*

TABLE OF CONTENTS

Acknowledgments	vii
Preface	ix
Glossary	xiii
Chapter One: Presage	1
Chapter Two: First Steps	23
Chapter Three: Stalin and the Rocket	69
Chapter Four: Sputnik	119
Chapter Five: Designing the First Spaceship	171
Chapter Six: Organizing for the Space Program	205
Chapter Seven: Gagarin	243
Chapter Eight : Looking to the Future	299
Chapter Nine: Space Politics	351
Chapter Ten: "There Are More Things in Heaven and Earth"	409
Chapter Eleven: Three Steps to the Moon	461
Chapter Twelve: A New Beginning	517
Chapter Thirteen: Tragedy	565
Chapter Fourteen: Getting Back on Track	609
Chapter Fifteen: Final Lap to the Moon	653
Chapter Sixteen: Options	699
Chapter Seventeen: Dreams Unfulfilled	745
Chapter Eighteen: Ashes to Ashes	799
Chapter Nineteen: Tomorrow Never Knows	839
Chapter Twenty: Coda	855

Bibliographic Essay.	861
Tables	
IA: Orbital Launch Attempts in the Soviet Piloted Space Program, 1960-74.	873
IB: Mission Parameters for Selected Orbital Flights	876
IC: Nonorbital Launch Attempts Supporting the Soviet Piloted Space Program, 1951-74	879
II: Cosmonaut Selection Groups, 1960-74	881
III: Administrative Organizations in the Soviet Missile and Space Programs. 1945-91	889
IV: Major Contractor Organizations in the Soviet Space Program. 1945-74	901
V: Space Launch Vehicle Designations	917
VI: Details of Launch Vehicles Used in the Soviet Piloted Space Program. 1957-74	921
VII: Designations for Piloted Space Vehicles.	925
VIII: Automated Launches Related to the Soviet Piloted Space Program. 1957-76 . .	931
IX: Governmental Decrees in the Soviet Missile and Space Programs, 1945-76. . . .	935
Appendices	
A: Soviet Piloted Space Projects, 1945-74	957
B: Dramatis Personae. 1945-74	965
Index.	979
The NASA History Series.	1007

CHALLENGE TO APOLLO

ACKNOWLEDGMENTS

This book is, in essence, sixteen years in the making. I first attempted to compile a history of the Soviet space program in 1982 when, encouraged by my mother, I put together a rough chronology of the main events. A decade later, while living on a couch in a college friend's apartment, I began writing what I thought would be a short history of the Soviet lunar landing program. The first draft was sixty-nine pages long. Late the following year, I decided to expand the topic to handle all early Soviet piloted exploration programs. That work eventually grew into what you are holding in your hand now. I wrote most of it from 1994 to 1997 in Northampton and Amherst, Massachusetts, and in Philadelphia, Pennsylvania, and completed the manuscript in December 1998.

It would have been difficult, if not impossible, to write this book without the generous assistance of numerous individuals who have spent years and in some cases decades trying to understand and analyze the arcana of the former Soviet space program. Writing this book was as much an exploration into research as it was a long journey making new acquaintances and friends from all over the world.

I am indebted to the staff at the NASA History Office—in particular to Lee Saegesser, Steve Garber, and Nadine Andreassen—for assisting me in my research despite their own busy schedules. Louise Alstork, Jonathan Friedman, Patricia Talbert, and John Edison Betts, Jr., were especially patient in proofreading the entire manuscript, making changes where necessary, and helping with the layout and final production. A most special note of gratitude to NASA Chief Historian Roger Launius, whose comments, encouragement, and guidance were indispensable to the completion of this book. This book would not have existed without his untiring support.

Of all the individuals who helped me with this book, I would particularly like to acknowledge the contributions of Peter Gorin, a recent Guggenheim Fellow at the Smithsonian's National Air and Space Museum. He generously shared notes, books, articles, comments, and his encyclopedic knowledge on any and every topic related to the Soviet space program. He also provided a lion's share of the illustrations and drawings used in this book.

I would also mention U.S. Air Force Lt. Colonel William P. Barry. Our countless exchanges via e-mail or letters were invaluable to coming to some understanding of the political and institutional processes that drove the early Soviet space program. I would have found it virtually impossible to write this book without the use of his remarkable analyses of the institutional history of the Soviet space program.

Dwayne Day at the Space Policy Institute at The George Washington University was an invaluable source for recently declassified U.S. government documents relating to Soviet programs. His insightful comments allowed me to frame many of my arguments in a more cogent manner.

My exchanges over e-mail with Bart Hendrickx and Mark Hillyer were essential to reexamining old events in a new light and eliminating many errors. Bart was very generous in sharing any materials that passed his way—a rare quality that set him apart from many other scholars in the field. Mark's vast knowledge about the sometimes mind-boggling and confusing histories of Soviet-era design bureaus helped me with my own studies on this arcane topic.

I want to give special thanks to T.A. Heppenheimer for his support throughout the project. His exhaustive knowledge of the history of space technology was useful in framing many of the main arguments of this work.

Igor Lissov of VideoCosmos in Moscow warrants special mention. He graciously answered many of my questions.

A very special thank you goes to Dennis Newkirk, the Russian aerospace analyst, for his never-ending efforts to provide me with materials useful for my work. He was one of the first Soviet "space watchers" with whom I communicated, and it was partially because of his encouragement that I began writing this book in the first place.

I would like to thank Glen Swanson, the founding editor of *quest: The History of Spaceflight Magazine*, for his constant material and moral support during the writing of this book. Glen also graciously shared his complete database of remarkable photographs, many of which I used in the book.

I would like to acknowledge the tireless contributions of the late Maxim Tarasenko for kindly facilitating my contacts with the RKK Energiya archivist Georgiy Vetrov. Maxim was one of the most brilliant space historians of his generation, and he will be sorely missed.

A very special note of thanks goes to Sergey Voevodin of Kostroma, Russia, who was an excellent source of information on the Soviet cosmonaut team.

Special thanks go out to Dr. Sergey Khrushchev, the late Dr. Georgiy Vetrov, and Dr. Gerbert Yefremov, all of whom graciously agreed to answer questions relating to the history of the Soviet space program and their own role in its early years. Their comments were invaluable in ferreting out details of previously hidden events in Soviet space history.

In addition to those named above, I would like to acknowledge the following for not only providing me with Russian-language material and photographs but also in many cases for answering detailed questions on various topics. They are: Igor Afanasyev, Vladimir Agapov, Michael Cassutt, Andrew Chaikin, Phillip Clark, James Harford, Christian Lardier, Jonathan McDowell, Peter Pesavento, and Joel Powell. I would also like to thank the following for providing many of the diagrams or photographs for the work: R. F. Gibbons, Dietrich Haeseler, Don Pealer, Charles Vick, Mark Wade, David Woods, and Steven Zaloga.

On a personal note, I would like to thank my mentor in Bangladesh, Fazlul Huq, and also Paul Thompson, Fred Ruppel, Inji, Sabina, Munmun, Karin Bell, Nadeem, Rahila, Bill Sparks, Rika, Dave Parnell, Pat, Jacqueline, the late musician Greg Black, Becky (who inspires), Heather, Karen Barth, Jill, and Danny. Thanks to the amazing Mandar Jayawantin in the hope that he will one day forgive me for not sharing my lunch with him. Thanks also to Paul, Iggy, Kurt, and Maynard.

A very special thank you to Anoo for being her wonderful self and for being so interested.

A very special note of love to my mother, who always told me that I could achieve anything as long as I worked hard enough for it; to my father, who bought me my first encyclopedia on spaceflight when I was twelve years old; to my sister Rochona, who endured years of my uncontrollable excitement over Soyuzes and Salyuts as an adolescent; and to her husband David, who graciously offered me an abode in which I could finish the book. Finally, a special thank you to Karen for being my best friend through all of this. I could not have written this book without her love and friendship.

PREFACE

On the Internet one day, I came upon a discussion of the space dog Layka, launched into orbit by the Soviet Union in 1957. Some people believed that the dog had died when oxygen finally ran out in her cabin. Others had heard that an automatic injection of poison had put her to sleep. Still others had read somewhere that poor Layka had literally burned up in the atmosphere when her capsule gradually fell to Earth. No one could point to a single source with any reasonable claim to authority on Layka's ultimate fate. The same news group carried a spirited discussion of U.S. space policy. The topic of choice was the heady period after the first Apollo Moon landing in 1969, in particular the political maneuvering behind the Nixon administration's approval of the Space Shuttle in 1972. Instead of quibbling over historical events, the emphasis was clearly on interpretation—a problem that had more to do with analysis than simply verifying the facts. The contrast between these two threads of conversation perfectly illustrated both the challenges and the differences in writing histories of the Soviet and American space programs. In one case, we are still disputing elementary facts and sources. In the other, we are disputing interpretations of facts and sources.

As astonishing as it may seem, the story of the Soviet space program, the world's first, has never been told in full. That is not to say that much has not been written on the topic. Western researchers during the 1970s and 1980s were able to interpret official exhortations in the Soviet press and discern some logic of the inner workings of the Soviet space program. All of these works had one major drawback: they were written at a time when the Soviets maintained very strict control over information, especially any that portrayed the space effort in a negative light. Many "facts"—that is, the raw skeleton of the story—were missing. All we had were accounts from the official Soviet media and rumor or speculation from unconfirmed sources—or a combination of both. Thus the range of issues that Western or even Soviet historians could address was severely limited.¹

Within Russian-language works, there are two relatively clear divisions in the historical record: those published before 1988, when the Soviet censorship apparatus consistently prevented an impartial representation of their efforts to explore space, and those published after, when the doors of the archives finally started opening up. The rupture was so great, it was as if everything written about the Soviet space program—and indeed almost every area of Soviet history—suddenly became obsolete by the turn of the 1990s. Entire programs, personalities, and even space missions of which we never knew all of a sudden came into focus, filling huge gaps in our understanding of the Soviet space effort during the Cold War. But it was not just a matter of filling in the blanks. The revisions and reassessments have been so pervasive that we could point to almost any event in the thirty-year span of the Soviet space and missile

¹ For the best Western accounts of the Soviet space program, see F. J. Krieger, *Behind the Sputniks: A Survey of Soviet Space Science* (Washington, DC: Public Affairs Press, 1958); William Shelton, *Soviet Space Exploration: The First Decade* (New York: Washington Square Press, 1968); Nicholas Daniloff, *The Kremlin and the Cosmos* (New York: Alfred A. Knopf, 1972); Peter Smolders, *Soviets in Space* (New York: Taplinger Publishing Co., 1973); Nicholas L. Johnson, *Handbook of Soviet Manned Spaceflight* (San Diego: Univelt, 1980); James E. Oberg, *Red Star in Orbit* (New York: Random House, 1981); Philip Clark, *The Soviet Manned Space Program: An Illustrated History of the Men, the Missions, and the Spacecraft* (New York: Orion, 1988); Dennis Newkirk, *Almanac of Soviet Manned Space Flight* (Houston: Gulf Publishing Co., 1990); Steven J. Zaloga, *Target America: The Soviet Union and the Strategic Arms Race, 1945–1964* (Novato, CA: Presidio, 1993); James Harford, *Korolev: How One Man Masterminded the Soviet Drive to Beat America to the Moon* (New York: John Wiley & Sons, 1997).

programs after World War II and find that our understanding of that singular occurrence has changed irrevocably.²

The recent disclosures have relevance far beyond the limited purview of Soviet space history. In the 1950s and 1960s, U.S. space policy to a large degree was a series of responses to what the Soviets were doing—or at least what policymakers *thought* the Soviets were doing. But despite its key role in shaping American space policy, there continues to be an abundance of ignorance or misinformation on the Soviet program. Many erroneous conjectures on Soviet space motives advanced by Western analysts during the Cold War have remained unquestioned by more recent scholars. Ultimately, any effort to make sense of the dynamics of space exploration during the Cold War, no matter how well-intentioned, will fall short without taking account of the recent revelations from the Russian side. What may be possible now is to take a second look not only at the Soviet space program, but also the U.S. space program—that is, to reconsider again humanity's first attempts to take leave of this planet.

Writing on a topic that has two dynamic parallel histories—one from the Cold War era and one from the post-Cold War era—is, for obvious reasons, a difficult problem. First, there is the challenge of creating context. One could easily lose the main thread of the story by annotating every episode with interpretations from two different time periods—that is, this is how the event was reported in the 1960s, and this is what *really* happened. I have tried as much as possible to avoid the pitfalls of such an approach, but at the same time, I have also not tried to shirk from the opportunity to contrast these two voices when they have served to embellish my story.

A second problem is one of identifying the right sources for the story. As much as possible, I have relied exclusively on Russian-language archival sources available in the post-1988 era. There are, however, several episodes in the narrative that warrant a wider historiographical context. Because of the dual nature of the history of the Soviet space program, different players in the effort have continued to promote contradictory accounts of the same event. For instance, Russian historians have never adequately addressed the use of German expertise in the immediate postwar period. They have generally minimized the German role as extremely peripheral. On the other side, the popular press in the West has had a tradition of dismissing early Soviet successes as merely an extension of German work. Can these two positions be reconciled in a scholarly treatise? In this case, the writing of history as an exercise in impartiality is caught between what is a somewhat dubiously established paradigm of history in the West and what is at best a history with missing chapters on the Soviet side. What I have tried to do is to use recently declassified information to provide a newer perspective, but one that is not necessarily divorced from the existing paradigms of yesteryears.

There are many such other cases in which Soviet space history has been artificially constrained between propaganda and speculation. This is one reason, I believe, that Soviet space achievements have generally been marginalized in the West and mythologized at home. For American historians, there is little debate on the holy grail of space history: it is the first landing of American astronauts on the surface of the Moon in 1969. On that July night in 1969, two men represented humanity's thirst for exploration, serving as ambassadors of the human

2. For the best recent Russian-language works, see Yu. A. Mozzhorin, *et al.*, eds., *Dorogi v kosmos: I* (Moscow: MAI, 1992); Yu. A. Mozzhorin, *et al.*, eds., *Dorogi v kosmos: II* (Moscow: MAI, 1992); Yaroslav Golovanov, *Korolev: fakty i mify* (Moscow: Nauka, 1994); Yu. A. Mozzhorin, *et al.*, eds., *Nachalo kosmicheskoy ery: vospominaniya veteranov raketno-kosmicheskoy tekhniki i kosmonavtiki: vypusk utroy* (Moscow: RNITsKD, 1994); B. Ye. Chertok, *Rakety i lyudi* (Moscow: Mashinostroyeniye, 1994); B. Ye. Chertok, *Rakety i lyudi: Fili Podlipki Tyuratam* (Moscow: Mashinostroyeniye, 1996); Yu. P. Semenov, ed., *Raketno-kosmicheskaya korporatsiya "energiya" imeni S. P. Koroleva* (Karolev: RKK Energiya, named after S. P. Korolev, 1996); V. V. Favorskiy and I. V. Mescheryakov, eds., *Voyenno-kosmicheskiye sily (voenno-istoricheskiy trud): kniga I: kosmonavtika i vooruzhennyye sily* (Moscow: VKS, 1997); B. Ye. Chertok, *Rakety i lyudi: goryachiye dni kholodnoy voyny* (Moscow: Mashinostroyeniye, 1997).

race in our first visit to another celestial body. For most American historians, everything before was simply a prelude and everything after has been a disappointment. Historians in Russia see things much differently. It was, after all, the Soviet Union that launched the first handiwork of humankind into orbit around Earth in 1957—Sputnik, or "fellow traveler." Only four years later came the second big milestone: the Soviet Union sent the first human into space. Yuriy Gagarin. Here was another huge moment, like that of the Apollo landing eight years later: for the first time since human life emerged on this planet, one of us had broken through the atmosphere that surrounds us and sped into the cosmos. But history has remembered Gagarin's short flight much differently. With the race to the Moon won, the American view of the Soviet space program changed dramatically: American historians remembered Sputnik and Gagarin not for their importance in human history, but only as catalysts for the decision to send humans to the Moon. There are works, too numerous to mention, on the repercussions of both Sputnik and Gagarin in the United States, but few on the historical meaning of these events divorced from geopolitics—as there was on Apollo. It is not surprising that this is so. With little film footage, paranoid secrecy, and no advance warning, the Soviets themselves were mostly responsible for consigning these events into that blurry historical limbo between propaganda and speculation. They eventually lost any claim to resonance that they might have had otherwise.

The Soviet space program was, of course, not simply propaganda nor speculation. It emerged from the ashes of World War II, when with Stalin's blessing, a group of ambitious engineers began testing old German missiles from the desert near the Aral Sea. With the onset of the Cold War and the explosion of the first Soviet atomic bomb in 1949, these experiments with rockets gained a new urgency. Many considered rockets, especially long-range ballistic missiles, an ideal way to deliver deadly atomic bombs across continents. Throughout the 1950s, as missile designers made vast advances in rocket design, it became possible to consider options that had little direct military utility—ideas such as space travel. Spurred by a small handful of visionary engineers devoted to the cause of space exploration, the Soviets diverted a strand of their military rocketry program into a single project to launch a satellite into orbit. Conceived as an exercise in scientific research, Sputnik was meant to be a modest contribution to an international effort to study Earth and its surroundings. While its scientific dividends might have been anticipated, no one could have predicted its political repercussions. After the launch of Sputnik on October 4, 1957, in the public image, the Soviet Union moved from being a nation of obsolete agricultural machines to a great technological superpower. Gagarin's flight less than four years later eliminated any remaining doubts about Soviet prowess in space exploration. In both cases, the Americans had lagged behind badly. These two pivotal achievements led eventually to the race to the Moon—a race of epic proportions that culminated in the Apollo landing in 1969. A span of only eight years separated the resounding victory of Gagarin and the crushing humiliation by Apollo. So what happened? What kind of effort did the Soviets mount to compete with Apollo? And why did it fail? I have tried to answer these questions by weaving together a record of the technical, political, and personal histories behind these three endeavors: the launch of Sputnik, the flight of Gagarin, and the challenge to Apollo.

My goal was not to write a history simply because it had never been written before. Certainly, recording the facts is an important exercise, but that would limit the job to a simple chronology. There are several major questions of interpretation that still have to be answered. I have only tackled a few of these.

The first major question has to do with discerning the institutional underpinnings of the Soviet space program. Given the new evidence, can we identify the primary constituencies that drove the effort? What kind of patterns of decision-making did they display? What interests were they serving? The record seems to indicate the importance of both individuals and institutions, all of whom emerged to power not because of the space program, but because of its antecedent ballistic missile development effort.

The second question addresses Soviet space technology. Our conventional understanding of Soviet space technology is generally framed in terms of obsolete products pushed through production-line processes that discourage major innovation. In the evolution of their early missile and space programs, did the Soviets adhere to the idea of incremental advances, or were there technological leaps? Did the Soviets benefit from foreign expertise during these early years? More often than not, the answers to these questions do not conform to our entrenched notion of how the Soviets managed technology in the Cold War era.³

Finally, why did the Soviets manage to beat the Americans in launching the first intercontinental ballistic missile, the first satellite, and the first human into space, but fail to beat the United States in landing the first person on the Moon? Was it simply because the last goal was significantly more challenging than the previous three? Or was it because, as was conventionally thought for many years in the West, that the Soviets simply did not want to race the Americans to the Moon? The answers to these questions are not simple: personal, institutional, political, and technological issues intersected in the complex schema of the Soviet Moon program, leading it to its final ignominious failure in 1969.

For this work, I have specifically focused on piloted space programs. In the first four chapters of this book, however, I delve into the origins of the Soviet long-range ballistic missile program and the events leading up to the launch of Sputnik. The following seven chapters cover the rise of the Soviet piloted space program under the tutelage of its founder, Sergey Pavlovich Korolev, ending with his premature death in 1966. The next seven chapters take the story up to 1974, covering the Soviet loss in the Moon race under the direction of Korolev's successor, Vasiliy Pavlovich Mishin. Finally, in the remaining two chapters, I briefly tell the story after 1974.

Note on Transliteration

I have used a modified version of the standard used by the U.S. Board on Geographic Names preferred by the University of Chicago Press. The drawback of this system is that it is often phonetically inappropriate. For example, the letter "e" is pronounced as "yo" in Russian. Thus "Korolev" should actually be pronounced as "Korolyov." There was one major exception to the Board of Geographic Names system: I have omitted the use of inverted commas (the "soft" and "hard" signs) within Russian words to reduce clutter in the text for those not familiar with the Russian language.

One other note is that NASA's normal convention has been to spell the Soviet cosmodrome "Baikonur," with an "i" instead of a "y." In this book, to be consistent with the rest of the transliteration, it is spelled "Baykonur." The reader will also find a difference in the spelling of some common first names, such as Sergei as Sergey and Yuri as Yuriy.

³ For Western works on the history of Soviet technology see for example Ronald Amann and Julian Cooper and R. W. Davies eds. *The Technological Level of Soviet Industry* (New Haven, CT: Yale University Press, 1977); Kendall E. Bailes, *Technology and Society Under Stalin: Origins of the Soviet Intelligentsia, 1917-1941* (Princeton, NJ: Princeton University Press, 1978); Ronald Amann and Julian Cooper eds. *Industrial Innovation in the Soviet Union* (New Haven, CT: Yale University Press, 1982); Bruce Parrot, *Politics and Technology in the Soviet Union* (Cambridge, MA: MIT Press, 1983); Matthew Evangelista, *How the United States and the Soviet Union Develop New Military Technologies* (Ithaca, NY: Cornell University Press, 1988); Loren R. Graham, *What Have We Learned About Science and Technology from the Russian Experience?* (Stanford, CA: Stanford University Press, 1998).

CHALLENGE TO APOLLO

GLOSSARY

AN SSSR	USSR Academy of Sciences
BOR	Unpiloted Orbital Rocket-Glider
BS	lateral stabilization
CIA	(U.S.) Central Intelligence Agency
CSAGI	Special Committee for the International Geophysical Year
DLB	Long-Duration Lunar Base
DOK	Engine Orientation Complex
DOS	Long-Duration Orbital Station
EOR	Earth-orbit rendezvous
EKR	Experimental Winged Missile
EPAS	Apollo-Soyuz Experimental Flight (Soviet name for the Apollo-Soyuz Test Project)
EPOS	Experimental Piloted Orbital Aircraft
EVA	extravehicular activity
FIAN	(P. N. Lebedev) Physical Institute of the USSR Academy of Sciences
FOBS	Fractional Orbital Bombardment System
GAU	Chief Artillery Directorate
GDL	Gas Dynamics Laboratory
GeoFIAN	Geophysical Institute of the USSR Academy of Sciences
GIPKh	State Institute of Applied Chemistry
GIRD	Group for Study of Reactive Motion
GKAT	State Committee for Aviation Technology
GKB	Lead Design Bureau
GKNPTs	State Space Scientific-Production Center
GKO	State Committee for Defense
GKOT	State Committee for Defense Technology
CKRE	State Committee for Radio Electronics
GMT	Greenwich Mean Time
GNII AiKM	State Scientific-Research Institute for Aviation and Space Medicine
GOGU	Chief Operations and Control Group
Gosplan	State Planning Organ
GR	global missile
GSKB	State Union Design Bureau
GSMZ	State Union Machine Building Plant
GTsP	State Central Range
GU	Chief Directorate
GUKOS	Chief Directorate of Space Assets
GULag	Chief Directorate of Camps
GURVO	Chief Directorate of Reactive Armaments
IAE	Institute of Atomic Energy
IAKM	Institute of Aviation and Space Medicine
ICBM	intercontinental ballistic missiles
IGY	International Geophysical Year
IKI	Institute of Space Research
IMBP	Institute for Biomedical Problems

IP	Measurement Point
IS	Satellite Destroyer
KB	Design Bureau
KB OM	Design Bureau of General Machine Building
KCB	Committee for State Security
KIK	Command-Measurement Complex
KORD	Engine Operation Control (system)
KPSS	Communist Party of the Soviet Union
KSU	command and signal instrument
KVTs	Coordination-Computation Center
LH ₂	liquid hydrogen
LI	Flight-Research Institute
LK	Lunar Ship
LKS	Light Space Aircraft
LOK	Lunar Orbital Ship
LOR	lunar-orbit rendezvous
LOX	liquid oxygen
MAI	Moscow Aviation Institute
MAP	Ministry of Aviation Industry
MEK	Martian Expeditionary Complex
MEP	Ministry of Electronics Industry
MIAN	Mathematics Institute of the Academy of Sciences
MIK	Assembly-Testing Building
MKB	Machine-Building Design Bureau
MKBS	Multirole Space Base-Station
MMZ	Moscow Machine-Building Plant
MNII	Moscow Scientific-Research Institute
MNII RS	Moscow Scientific-Research Institute for Radio Communications
MO	Ministry of Defense
MOK	Multirole Orbital Complex or Martian Orbital Complex
MOL	Manned Orbiting Laboratory
MOM	Ministry of General Machine Building
MOP	Ministry of Defense Industry
MP	maneuvering, piloted
MPK	Martian Landing Complex
MRP	Ministry of Radio Industry
MSM	Ministry of Medium Machine Building
MTKVP	Reusable Vertical-Landing Transport Craft
MVTU	Moscow Higher Technical School
MZ	Machine Building Plant
NASA	National Aeronautics and Space Administration
NATO	North Atlantic Treaty Organization
NEK	Scientific-Experimental Complex
NIEI PDS	Scientific-Research and Experimental Institute of the Parachute Landing Service
NII	Scientific-Research Institute
NII AP	Scientific-Research Institute for Automation and Instrument Building
NII AU	Scientific-Research Institute for Aviation Equipment
NII IT	Scientific-Research Institute for Measurement Technology
NII P	Scientific-Research Institute for Instrument Building
NII PM	Scientific-Research Institute for Applied Mechanics

CHALLENGE TO APOLLO

GLOSSARY

NII RP	Scientific-Research Institute for Rubber Industry
NII TP	Scientific-Research Institute for Precision Instruments or Scientific-Research Institute for Thermal Processes
NIIP	Scientific-Research and Test Range
NIP	Scientific-Measurement Point
NITI	Scientific-Research and Technical Institute
NKVVD	People's Commissariat for internal Affairs
NORAD	North American Air Defense Command
NPO	Scientific-Production Association
NS	normal stabilization
NTK	Scientific-Technical Committee
NTS	Scientific-Technical Council
OK	orbital ship
OKB	Special or Experimental Design Bureau
OKB MEI	Experimental Design Bureau of the Moscow Power Institute
OPM	Department of Applied Mathematics
OPS	Orbital Piloted Station
OTK	Special Technical Commission
PKA	Gliding Space Apparatus
PVO	Air Defense Forces
RKK	Rocket-Space Corporation
RKS	Adjustment of Apparent Velocity
RNII	Reactive Scientific-Research Institute
RVSN	Missile Forces of Strategic Designation (Strategic Missile Forces)
SALT	Strategic Arms Limitation Talks
SKB	Special Design Bureau or Serial Design Bureau
SKG	Special Design Group
SOBIS	simultaneous emptying of tanks
SOKB	Union Experimental Design Bureau
SOUD	System of Orientation and Motion Control
SOZ	System for Ensuring Firing
SP	Special Publication (NASA)
SR	Suborbital Rocket-Glider
TASS	Telegraph Agency of the Soviet Union (Soviet news agency)
TDU	Braking Engine Unit
TGU	Third Chief Directorate
TKA	Transport-Supply Ship
TLI	translunar-injection
TMK	Heavy Interplanetary Ship
TMKB	Turayev Machine-Building Design Bureau
TMZ	Tushino Machine Building Plant
TNT	trinitrotoluene
TOS	Heavy Orbital Station
TsAGI	Central Aerohydrodynamics Institute
TsIAM	Central Institute of Aviation Motor Building
TsK	Central Committee
TsKB	Central Design Bureau
TsKBEM	Central Design Bureau of Experimental Machine Building
TsKBM	Central Design Bureau of Machine Building
TsKIK	Central Command-Measurement Complex

TsNII	Central Scientific-Research Institute
TsNII Mash	Central Scientific-Research Institute for Machine Building
TsPK	Cosmonaut Training Center
TsSKB	Central Specialized Design Bureau
TsUKOS	Central Directorate of Space Assets
TsUP	Flight Control Center
UDMH	unsymmetrical dimethyl hydrazine
UHF	ultrahigh frequency
UNKS	Directorate of the Commander of Space Assets
UNRV	Directorate of the Commander of Reactive Armaments
UPMK	Cosmonaut Maneuvering and Motion Unit
UR	universal missile
US	Controlled Satellite
USSR	Union of Soviet Socialist Republics
UZKA	Directorate of the Deputy Commander of Artillery
VHF	very high frequency
VIAM	All-Union Institute for Aviation Materials
VMF	Soviet Navy
VNII	All-Union Scientific-Research Institute
VNII EM	All-Union Scientific-Research Institute for Electro-Mechanics
VNII IT	All-Union Scientific-Research Institute for Current Sources
VPK	Military-Industrial Commission
VSNKh	All-Russian Council of the National Economy
VTs	Computation Center
VVS	Soviet Air Force
YaERD	nuclear-electric rocket engine
ZIKh	M. V. Khrunichev Machine Building Plant

CHALLENGE TO APOLLO

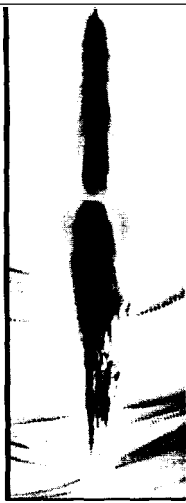

CHAPTER ONE

PRESAGE

Origins

The rocketry and space programs of the Soviet Union had their origins in the late 1800s with the farsighted and at times farfetched writings of a deaf, self-taught school teacher named Konstantin Eduardovich Tsiolkovskiy. Born in 1857, Tsiolkovskiy had produced a series of thirty small monographs in the late 1800s, culminating in his classic work "Exploration of the Universe with Rocket-Propelled Vehicles," published in the May 1903 issue of the St. Petersburg journal *Nauchnoye obozreniye* (*Scientific Review*). In this and later works, Tsiolkovskiy elucidated his complex ideas on rocketry and space exploration, supporting most of his conceptions with complex mathematical analyses. In his most revolutionary idea, he proposed that humans could hope to fly to very high altitudes and ultimately into outer space only by using liquid-propellant rockets. One of his most important conclusions was that a rocket would be capable of carrying up a cargo of any size, and develop any speed desired, as long as the rocket was sufficiently large and the ratio of the mass of the propellant to the mass of the entire rocket was large enough—a relationship that is known as the Tsiolkovskiy Equation.¹

While some of his work was clearly in the realm of fantasy, the breadth of his contribution to astronautics is astounding. In his early work, he wrote eloquently on such topics as multistage rockets, high-energy liquid propellants such as liquid oxygen and liquid hydrogen, giant space stations in Earth's orbit with food regeneration systems, and the dangers of high temperatures on an object returning to Earth. He even investigated the idea of a spacesuit for activity in open space. Tsiolkovskiy was a generation older than two other equally famous founders of theoretical and practical astronautics: the American Robert H. Goddard and the Rumanian Hermann Oberth. All three, quite independently, pursued their extraordinary ideas on rocketry and space exploration, but Tsiolkovskiy was perhaps a bit more pessimistic than his peers. Unlike Goddard, who launched the world's first liquid propellant rocket in 1926, Tsiolkovskiy was unable to build even a small rocket. He apparently believed that few of his conceptions of the future would ever be brought to fruition.

1 V. P. Glushko, *Development of Rocketry and Space Technology in the USSR* (Moscow: Novosti Press Publishing House, 1973), p. 9; Evgeny Riabchikov, *Russians in Space* (Moscow: Novosti Press Publishing House, 1971), p. 98; Nicholas Daniloff, *The Kremlin and the Cosmos* (New York: Alfred A. Knopf, 1972), p. 17. The 1903 publication was only the first part of the article. When the journal was closed down with the May issue, Tsiolkovskiy had to wait until 1911 to see the second part published in *Vestnik vozdukhoplavaniya*.

2 For an English language summary of Tsiolkovskiy's work, see A. A. Blagonravov *et al.*, *Soviet Rocketry: Some Contributions to its History* (Jerusalem: Israel Program for Scientific Translations, 1966), pp. 68–126; Daniloff, *The Kremlin and the Cosmos*, pp. 13–17.

In the early part of the 1900s, Tsiolkovskiy's ideas received little if any attention as a result of both the extreme mathematical nature of his work and a general disinterest from the Czarist government. The Bolshevik Revolution in 1917 seems to have aroused a modicum of interest in his ideas from the new Soviet leadership. This was partly to illustrate the Czarist government's lack of foresight, but also tied to new ideology: "In Communist theory, technological progress was virtually equivalent to the march of history." The year after the Revolution, Tsiolkovskiy was elected a full member of the prestigious Russian Socialist Academy. Later in 1921, he was granted a lifetime pension in honor of his groundbreaking scientific contributions on space exploration and rocketry.⁴ Given his strong support for the Revolution, the Soviet government was only too eager to promote his writings.

In the Western historiography of the early history of astronautics, Tsiolkovskiy's name is the best known. But within Russia and later the Soviet Union, there were two other remarkable visionaries who played as great a role in inspiring a new generation of young amateurs as the great Tsiolkovskiy himself. One of these was Yuriy Vasilyevich Kondratyuk, a man who had a life as amazing as any figure in the history of Soviet rocketry. He was born Aleksandr Ignatyevich Sharkey in 1897 in the Ukraine. Brilliant even in his childhood, he published his seminal works in his twenties and thirties, the first, *Tyem, kto budet chitat chtoby sroyit* (To Those Who Will Read in Order to Build), in 1919 and the second, *Zauoyeuaniye mezhplanetnykh prostranstv* (The Conquest of *Interplanetary Space*), in 1929. In these works, Sharkey showed a remarkable grasp of problems in rocket dynamics and engineering. Unaware of Tsiolkovskiy, he came to many of the same conclusions and extended the field of astronautics to new areas. Among the topics he described were minimum-energy spaceflight trajectories to other planets, the theory of multistage rockets, intermediate interplanetary ship refueling bases, and the landing of probes on planets using atmospheric drag. One of his most famous contributions to the literature was the formulation of a mission profile for a lunar landing using two separate vehicles, a mother ship in lunar orbit, and a lander on the surface. When American astronauts landed on the Moon in 1969, they used very much the same idea.⁵

Sharkey's career was cut short by the strangest of circumstances. In 1916, he had been conscripted into the Army to fight on the Caucasus front in Turkey. After the Bolsheviks came to power in October 1917, Sharkey decided to leave the Army, but on his journey back home, he was conscripted by the rebel White Army to fight the communists. He eventually deserted but was found by the White Army again in Kiev, where he joined their ranks briefly before deserting again. After the Revolution, he was in a difficult position. To the Whites, he was a habitual deserter, and to the Reds, he was an officer in the White Army—both sides wanted him shot. To save his life, his stepmother sent him some documents of a man named Yuriy Vasilyevich Kondratyuk, who was born in 1900 and died on March 1, 1921, of tuberculosis. On August 15 of the same year, Sharkey assumed his new identity and tried to lead an inconspicuous life, far from the public eye. Terrified of being found out, he did not join the amateur rocketry groups of the Soviet Union in the 1920s and 1930s despite his lifelong passion for rocketry. He died sometime in late February 1942 defending Moscow against the Nazis. His grave was never found.⁶

3 Walter McDougall *The Heavens and the Earth: A Political History of the Space Age* (New York: Basic Books, 1985) p. 27

4 Daniloff *The Kremlin and the Cosmos* 1972 p. 19; William P. Barry "The Missile Design Bureaux and Soviet Piloted Space Policy 1953-1970" Ph.D. thesis in Politics, Faculty of Social Studies, University of Oxford, 1996

5 G. V. Petrovich, ed. *The Soviet Encyclopedia of Space Flight* (Moscow: Mir Publishers, 1969) pp. 209-10

6 Valeriy Rodikov "Who Are You, Engineer Kondratyuk?" (English title) in V. Shcherbakov, ed. *Zagadki zvezdnykh ostrovov kniga pyataya* (Moscow: Molodaya gvardiya, 1989) pp. 36-53

The third major figure of the period was Fridrikh Arturovich Tsander, born in 1887 in Riga, the capital of Latvia. By his late twenties, Tsander had but one aim: to acquire the necessary knowledge to make a journey into space. In 1921, he gave a report at an inventors' conference on his pet project for an interplanetary aircraft. Three years later, he published his landmark work in the journal *Tekhnika i zhizn (Technology and life)* titled "Flight to Other Planets," in which he expounded on the design of rocket engines, calculations for interplanetary trajectories, and conceptions of safety systems. One of his favorite ideas was of a combined rocket-aircraft for takeoff from Earth, which would consume its own metallic wings as propellants after flight through the atmosphere. He amplified this and several other concepts in another book published in 1932 titled *Problema poleta pri pomoshchi reaktiunyykh apparatou (The Problem of Flight by Means of Reactive Vehicles)*. Perhaps Tsander's most famous contribution was his untiring popularization of spaceflight in the late 1920s by lecturing on the topic across the Soviet Union.⁷

The increased visibility of rocketry and space exploration in the public eye in the late 1920s, through exhibitions and special publications, were crucial to inspiring a new, younger generation of Soviet engineers—those born this century, who would eventually direct the course of the world's first space program. This group of individuals came to prominence in the 1930s with the formation of small rocketry societies in Moscow and Leningrad dedicated to the design and construction of short-range liquid-fueled rockets. In many ways, the influence and power that these men wielded in their later years was far more imposing than the same possessed by their counterparts in the concurrent rocketry societies in the United States and Germany. This is, perhaps, one of the key distinctions in historical perspective in looking at the space programs of the United States and the Soviet Union. In the former, the pioneers were defined by their institutions, and in the latter, the pioneers were the institutions.

In the Soviet Union, the most important of these individuals was Sergey Pavlovich Korolev, a former mechanical engineer who was to become the *de facto* head of the Soviet space program and remained so until his untimely death in 1966. It would not be an overstatement to say that without his guidance, administrative powers, and vision, the Soviet Union would not have become the foremost space-faring nation in the world in the late 1950s and early 1960s. Korolev was born on December 30, 1906, in the town of Zhitomir in the Ukraine.⁸ His natural parents were divorced when he was three years old, and the young Korolev was shuffled from city to city until his mother remarried. He did not attend school until he was fourteen, studying only at home with tutors.

Korolev's first passionate interest was aeronautics, and from an early age, he read voraciously on the exploits of aviation pioneers throughout the world. At the age of seventeen, he joined a glider club in the town of Odessa and eventually became the leader of the aeronautics club there. In 1926, he enrolled in the Moscow Higher Technical School in the Department of Aerodynamics as an advanced student and for the first time came into contact with famous Soviet aeronautical designers such as Andrey N. Tupolev, who was a professor at the university. As part of his thesis work at the school, Korolev designed and built a full-scale glider that he later flight-tested: this and other glider projects were brought to fruition by 1930, and Korolev graduated in February of that year as an "aeromechanical engineer."⁹ Immediately following graduation, he was asked to begin work as an engineer at the V. P. Menzhinskiy Central Design Bureau headed by Chief Designer Dmitriy P. Grigorovich, where the work was far more ambitious than his modest

7 Petrovich ed. *The Soviet Encyclopedia of Space Flight* p. 468

8 A. P. Romanov and V. S. Gubarev *Konstruktor* (Moscow: Politicheskoy literatury, 1989) p. 16; Yaroslav Golovanov *Sergei Korolev: The Apprenticeship of a Space Pioneer* (Moscow: Mir Publishers, 1975) p. 23. The date of his birth in the "new" Gregorian calendar adopted following the Great October Revolution is January 12, 1907.

9 Golovanov *Sergei Korolev* pp. 135–36, 170; Romanov and Gubarev *Konstruktor* pp. 31–33. Among his graduating class was the later chief designer of aircraft and missiles, Semyon A. Lavochkin.

gliders. There, he was part of an engine design group working on a new heavy bomber named the TB-5. Within five months, he was finally transferred to the prestigious Central Aerohydrodynamics Institute (known as "TsAGI" in its Russian abbreviation) in Moscow. By all accounts, he was considered a promising aeronautical engineer and by that time had authored several articles on aviation, gliders, and light aircraft."

It was during this period that Korolev for the first time became seriously enamored with the possibilities of space exploration and rocketry. He had maintained a fairly cursory interest in space travel since the late 1920s as a result of several well-publicized exhibitions in the Soviet Union that showcased the works of Coddard, Oberth, Tsiolkovskiy, and Kondratyuk. Korolev's overriding passion during the late 1920s was, however, aeronautics, and it seems that he was not "converted" until he had contact with several resourceful engineers employed at TsAGI in 1930. Among these individuals was the forty-four-year-old Tsander. By that time, Tsander had unsuccessfully requested the government to support his rocketry experiments, but such practical efforts evoked little interest from the leadership." In December, Tsander posted an advertisement in the Moscow newspaper *Vechernyaya moskva* calling for responses from those interested in "interplanetary communications," a euphemism for space travel." Many of the 150 people who responded met several times in early 1931 under Tsander's direction to discuss the possibility of establishing an amateur group to focus on the practical aspects of rocketry and space exploration. The early meetings led to the formation, on July 18, 1931, of the so-called Bureau for the Investigation of Reactive Engines and Reactive Flight. By early September, the society's name was changed to the Group for the Investigation of Reactive Engines and Reactive Flight (better known by its Russian acronym "GIRD").¹³ Korolev joined forces with Tsander at this time, impressed by Tsander's claim that he could build a rocket engine. The young Korolev had the germ of an idea to combine a rocket engine with a glider and create a high-altitude aircraft.

Tsander's group at GIRD was formally under the jurisdiction of the voluntary Society for the Promotion of Defense, Aviation, and Chemical Production (or "Osoaviakhim"), a governmental entity that sponsored amateur and premilitary activities among Soviet youth in such areas as gliding, auto racing, hot-air balloons, and glider construction. The Moscow branch of GIRD was only the first of many groups interested in rocketry that sprouted in the ensuing months in such cities as Arkhangelsk, Baku, Bryansk, Kharkov, Leningrad, Novocherkassk, and Tiflis. By June 1932, Osoaviakhim had formalized a relationship with the Moscow GIRD (also called the Central GIRD) that set the stage for modest amounts of financial support for their activities. Under Tsander's leadership, the Moscow GIRD was particularly successful in its early incarnation and conducted public lectures and courses and even published a number of books on rocketry. Along with these promotion efforts, Tsander and Korolev were also interested in practical work in the building of rockets and were able to work overtime on their experiments in a small wine cellar on Sadovo-Spasskiy Street in Moscow.¹⁴

10 Aleksandr Romanov Korolev (Moscow: Molodaya gvardiya, 1996) pp. 88-89. The works of the Central Design Bureau and TsAGI were actually merged at the time.

11 An English language summary of Tsander's work can be found in F. A. Tsander, *Problems of Flight by Jet Propulsion: Interplanetary Flights* (Jerusalem: Israel Program for Scientific Translations, 1964). See also Barry 'The Missile Design Bureaus'.

12 Romanov and Cubarev, *Konstruktory*, p. 35; Christian Lardier, *L'Astronautique Soviétique* (Paris: Armand Colin, 1992) p. 19.

13 C. S. Vetrov, S. P. Korolev, *Kosmonavtika: peruye shagi* (Moscow: Nauka, 1994) pp. 35-36. The actual date for the formation of GIRD has not been ascertained by Soviet or Russian historians. The current interpretation is that the group was set up sometime between September 1 and 20. The earliest preserved document mentioning the organization is dated September 23, 1931, and is reproduced in Vetrov, S. P. Korolev, *Kosmonavtika*, p. 38.

14 Clushko, *The Development of Rocketry and Space Technology*, p. 15; Riabchikov, *Russians in Space*, p. 105.



The original members of the GIRD team are shown here in 1932. Top center is Yury Pobedonostsev, while bottom center is Sergey Korolev. On the extreme right is Fridrikh Tsander, the space visionary who founded the group. (files of Asif Siddiqi)

Among the other early members of GIRD were Mikhail Klavdiyevich Tikhonravov, who was thirty-one years old, and Yuriy Aleksandrovich Pobedonostsev, only twenty-four, both of whose contributions to the early achievements of the Soviet rocketry and space programs would be invaluable. Although they were not officially supported by the Soviet government, the engineers and technicians at GIRD were infected by an unusually vivid sense of enthusiasm and optimism. In particular, Korolev's whole life had begun to revolve around ideas of rocketry and astronautics, and there were many discussions during GIRD's early days of sending rockets into space and landing people on Mars. One of the more common inspiring phrases of the engineers was reportedly: "To Mars! To Mars! Onward to Mars!" This was a phrase that Tsander would use to greet his fellow workers. He had even named his two children Merkurii ("Mercury") and Astra.¹⁵ The economic situation in the Soviet Union at the time, however, necessitated that their interests in rocketry and aeronautics would have to be financed by themselves. These limitations, although considerable, did not cause much hesitation on their part, and the group often sold family valuables to finance their private endeavors. They usually labored in their spare time, and the fact that there was no obvious profit in such work was not an issue of great concern. Unlike Tsander, who had little interest in acquiring leadership skills, Korolev was a natural focus of the group, and in addition to his increasing technical expertise, he developed sharp managerial and administrative skills—assets that would serve him well in his later days. He had become completely absorbed in the idea of spaceflight by this time. It was a dream that he would never abandon.

¹⁵ Riabchikov *Russians in Space* p 106 Yaroslav Golovanov *Korolev fakty i mify* (Moscow Nauka 1994). p 132

On May 1, 1932, Korolev replaced the ailing Tsander as the formal leader of the GIRD organization, and simultaneously four different divisions were formed to further optimize their rocketry efforts—groups led by Tsander, Tikhonravov, Pobedonostsev, and Korolev himself. Most of their efforts were focused on the development of low-thrust liquid-propellant engines for small handmade rockets and gliders.¹⁶ Under Korolev's leadership, the work at GIRD also took a significant turn as he began to extract larger amounts of funding to pay GIRD members and obtain better equipment for building rockets and gliders. He also encouraged strict professionalism among all the workers and quickly became known among larger circles as not only a bright engineer but also an efficient organizer. Just three months following Korolev's appointment, the Soviet government's Directorate of Military Inventions began financing some of the organization's work, although the group still remained subordinate to the amateur Osoaviakhim." The work at the organization finally culminated in the late summer of 1933 with the first launches of what would eventually be the first Soviet liquid-propellant rocket. Designated the 09, the 2.2-meter-tall vehicle had been designed by a team under Tikhonravov. Powered by jellied petroleum burning in liquid oxygen, the rocket was loaded up in a truck and taken to the Nakhbino firing range outside of Moscow for its first launch on August 11, 1933. This attempt and a second one on August 13 were failures, but a third try on the 17th went down in history. After a precariously slow liftoff, the rocket reached a modest altitude of about 400 meters during thirteen seconds of flight.¹⁸ In a moment of exhilaration, Korolev authored a short article for the GIRD news flyer:

The first Soviet liquid-propellant rocket has been launched. The day of August 17 will undoubtedly be a memorable day in the life of GIRD, and from this moment Soviet rockets should start flying above the Union of Republics. . . . Soviet rockets must conquer space!"

Although it was the first resounding success for GIRD, the organization's spiritual guide was not present to witness the event. Tsander had been suffering from exhaustion caused by overwork, and some of his associates had forced him to take a vacation. On the journey to a health spa, Tsander contracted typhus and collapsed. He died without regaining consciousness on the morning of March 28, 1933.²⁰ In one sense, Tsander's death presaged the end of an era of amateur Soviet rocketry. Within months, Korolev and his associates would find themselves in the employ of the Soviet government.

The Soviet military had actually sanctioned the formation of a small government rocketry research laboratory in Moscow on March 1, 1921, to conduct work on "rocket projectiles."²¹ Unlike the GIRD efforts, however, all the research at this laboratory was dedicated to the development of solid-fuel rocket engines for artillery. This group, headed by a chemical engineer named Nikolay I. Tikhomirov, was moved to Leningrad in June 1928 and renamed the Gas Dynamics Laboratory (GDL) of the Military Scientific Research Commission. The following year, in May 1929, a special group (the "Second Section"), headed by a young engineer named Valentin Petrovich Glushko, had been brought into GDL to specifically conduct research on electric rocket engines.²² Born on August 20, 1906, Glushko had converted to space exploration

16 The main work at GIRD prior to March 1932 was the development of the OR 1 and OR 2 rocket engines for use with an experimental glider named the BICH 11. See Vetrov S. P. Korolev i kosmonavtika p 46

17 *Ibid* pp 50-70

18 *Ibid* p 69 Golovanov Sergei Korolev pp 273-74

19 Golovanov Sergei Korolev pp 274-75

20 Riabchikov Russians in Space p 109 Golovanov Korolev pp 147-48

21 Glushko The Development of Rocketry and Space Technology p 6

22 *Ibid* p 12 Riabchikov Russians in Space p 86

early through his voracious readings of the works of Jules Verne—so much so that at the age of fifteen, he had written a letter to Tsiolkovskiy. "Just three years later in July 1924, only eighteen years old, he had published an article in the popular press titled "Conquest of the Moon by the Earth." Even more impressively, in 1926, Glushko authored a work titled "Extraterrestrial Station" in the journal *Nauka i tekhnika* (Science and *Technology*).²⁴ A soft-spoken individual with somewhat of a stern disposition, Glushko no doubt saw a chance at realizing his dream of space exploration as an engineer for GDL. Recognizing his exceptional technical capabilities, the leaders of CDL had redirected Glushko in 1931 to start work on liquid-propellant rocket engines for military applications.

By 1931, there were two major independent rocketry organizations in the Soviet Union—one active in the design of rockets (GIRD) and the other focused on rocket engines (GDL).

Around this time, the two groups began developing informal contacts with each other and began negotiations to explore the possibility of coordinating their work. Following a long and elaborate series of discussions, aided by strong lobbying from Marshal Mikhail I. Tukhachevskiy, the Deputy People's Commissar for the Army and Navy, GIRD and GDL were consolidated into one organization in the fall of 1933. The official decree (no. 0113) from the Revolutionary Military Council was issued on September 21, 1933, and called for the formation of the Reactive Scientific-Research Institute (RNII).²⁵ Tukhachevskiy appointed Ivan T. Kleymenov, the former head of the now defunct GDL, to serve as the new RNII's first director. Korolev, no longer an amateur rocketeer, was appointed Kleymenov's deputy.

Tukhachevskiy had originally envisioned RNII as a breeding ground for advanced liquid- and solid-propellant missiles for use by the artillery sector, but this idea faced some resistance from higher placed military leaders. Uninterested in the future prospects of rockets, the military refused to let Tukhachevskiy have jurisdiction over the new institute. Instead, a little over a month after its formation, on October 31, RNII placed under the jurisdiction of the People's Commissariat of Heavy Industry, the "ministry" responsible for production of several major ground-based weapons.²⁶ At the same time, there was a clash between Kleymenov and Korolev

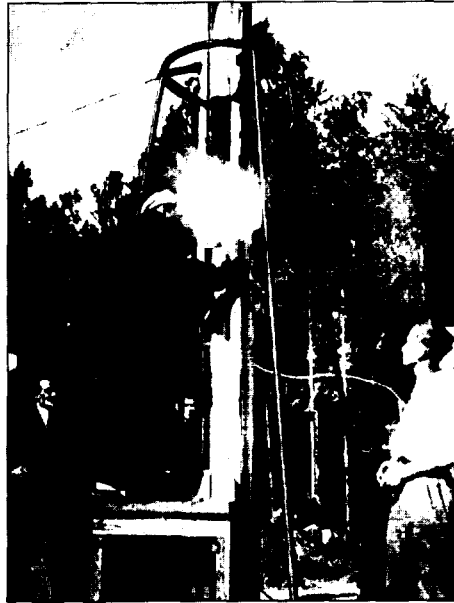

The GIRD team is shown here in 1933 feeding liquid oxygen to the "09," the first Soviet liquid-propellant rocket. From left to right are Sergey Korolev, Nikolay Yefremov, and Yuriy Pobedonosisev (files of Asif Siddiqi)

23 Romanov and Gubarev, *Konstruktor*, p. 274. The letter was dated September 26, 1923. Tsiolkovskiy replied within a month.

24 Col. M. Rebrov, "Specific Impulse" (English title), *Krasnaya zvezda*, August 26, 1989, p. 4. The 1926 article was published as V. P. Glushko, "Extraterrestrial Station" (English title), *Nauka i tekhnika* 40 (October 8, 1926): 3-4.

25 Vetrov, S. P. Korolev i kosmonavtika, p. 76; Glushko, *The Development of Rocketry and Space Technology*, p. 17.

26 Glushko, *The Development of Rocketry and Space Technology*, pp. 17-18. This was formalized by a second decree (no. 104) from the Council of Labor and Defense on October 31, 1933.

over the thematic direction of the institute. The former was not a rocketry specialist; it was well known that he had a poor understanding of the field in general, believing that the institute's most urgent mandate should be the creation of solid-propellant artillery shells. When Korolev disagreed, Kleymenov demoted him to the section chief on winged missiles.²⁷ It was a change in jobs that probably saved Korolev's life in later years. A former CDL veteran and accomplished solid-propellant engineer named Georgiy E. Langemak was tapped to fill Korolev's old position. To the latter's disappointment, some of the more interesting projects, such as the development of liquid-propellant rocket-powered aircraft, were dropped from the institute agenda at the time."

A second reorganization was enacted by Kleymenov in May 1935 as RNII was divided into four major sectors emphasizing solid-propellant missiles, solid-propellant takeoff accelerators for military aircraft, launch installations for solid-propellant rockets, and liquid-propellant missiles.²⁸ Korolev's primary interest was the development of rocket gliders, but this area of focus seems to have rapidly diminished in terms of its value in the eyes of the RNII leadership. Korolev himself initially worked on several high-altitude rockets before he found himself leading efforts on a number of promising long-range winged missiles for military applications. Glushko and Tikhonravov undertook most of the work on liquid-propellant engines, and although some of these engines found use on gliders and missiles, most were never installed on any working designs.

Unhappy with the work at RNII, Marshal Tukhachevskiy sanctioned the establishment, in August 1935, of a separate organization in the General Staff's Chief Artillery Directorate, designated Design Bureau No. 7, to focus exclusively on liquid oxygen missiles—an area of research that the RNII leadership had neglected.²⁹ The original goal of creating a centralized rocketry research organization gradually became subsumed under conflicts resulting from clashes between the proponents of solid propellants and liquid propellants. Earlier, on the seventy-fifth anniversary of Tsiolkovskiy's birth, several speakers from the USSR Academy of Sciences mocked the great visionary's ideas as impractical and of little use. The conflict was exacerbated by the opinions of former CDL researchers at RNII who continued to view the amateur GIRD veterans as "crackpots" without any connection to reality.³⁰ After Tsiolkovskiy's death in 1935,

27 Vetrov *S. P. Korolev i kosmonautika* p. 77

28 Yu. Biryukov 'Life Aspiring to Higher Goals (on the 90th Birthday of S. P. Korolev)' (English title) *Novosti kosmonautiki* 1 (January 1-12 1997) 63-67

29 Lardier *L'Astronautique Soviétique* pp. 31-34

30 Glushko *Development of Rocketry and Space Technology* p. 19. Barry "The Missile Design Bureaux 'Design Bureau No. 7 (KB 7)' was primarily composed of engineers who had "defected" from RNII. Later histories of the early Soviet rocketry program dismissed the efforts of KB 7 as a failure, but in truth, the activities at this bureau were quite successful given the circumstances. Led by former RNII engineers L. K. Korneyev and A. I. Polyarniy, KB 7 developed a series of increasingly complex rockets for exploring high altitudes. One of these, although never launched, was the R-05, one of the first Soviet rockets designed exclusively for investigations of the upper atmosphere. Special instruments were developed by the Optics Institute and the Chief Geophysical Observatory for this rocket. KB 7 also designed several complex guidance and gyroscope systems, some of them as sophisticated as those developed at RNII. A second independent effort was continued by amateur engineers of the former GIRD who had elected not to be part of the governmental RNII. Solid propellant missiles such as the VR-3 and the TR-3 were developed under the leadership of I. A. Merkulov in the Reaction Section of the Stratospheric Committee of Osoaviakhim. The latter organization also developed some of the first ramjet engines for rocket applications. Both these efforts, however, were discontinued by the late 1930s. KB 7 itself was dissolved in 1939 following a decision by the Artillery Directorate that liquid propellant missile research was not a useful avenue of military research. See Glushko *The Development of Rocketry and Space Technology* p. 19, the author writes that KB 7 "failed to produce the desired results." See also I. A. Merkulov "Organization and Results of the Work of the First Scientific Centers for Rocket Technology in the USSR" in Frederick I. Ordway III, ed. *History of Rocketry and Astronautics*, Vol. 9 (San Diego, CA: American Astronautical Society, 1989), pp. 70-72-73. Lardier *L'Astronautique Soviétique* pp. 39-41-43. Riabchikov *Russians in Space* pp. 128-29.

31 For an excellent summary and analysis of the events at RNII in the 1930s, see Barry "The Missile Design Bureaux."

interest in rocketry, let alone space travel, very visibly declined as the Soviet government began to slowly withdraw from its earlier support for such technologies.

Despite the organizational discord in RNII, there was a significant amount of research on rocketry conducted during that period. Korolev himself made a presentation at the All-Union Conference on Stratospheric Studies in Leningrad in March and April 1934, calling for the development of scientific instruments for high-altitude rockets to study the upper atmosphere." In December, Korolev authored a slim volume titled *Raketnyy polet v stratosfere* (Missile Flight Into the Stratosphere), in which he considered for the first time the launch of humans to high altitudes. He conceded that given the current state of Soviet technology, such a plan might be somewhat premature. The following year, Korolev, Glushko, Tikhonravov, Pobedonostsev, and other engineers at RNII actively participated in a Moscow workshop, the All-Union Conference on the Uses of Rocket-Propelled Craft for the Exploration of the Stratosphere, dedicated completely to the possibilities of high-altitude science using powerful rockets."

Korolev was personally involved in the design of several missiles for military applications beginning in the mid-1930s. These initially included high-altitude missiles but progressively encompassed the design and construction of winged missiles.³⁴ Work on the latter rockets was used as the basis for the development of one of the first practical rocket plane designs in the Soviet Union, designated the RP-318. Conceived in July 1936, intensive static engine firings were conducted in late 1937 and early 1938 in preparation for the first flight, which Korolev intended to make himself." Glushko and Tikhonravov at the same time worked independently on other projects, the former developing at least fifty different low-thrust nitric-acid-based rocket engines for a variety of applications. Many of these units had relatively high-performance characteristics, with thrust levels as high as 600 kilograms. Thus, although the original goals of Korolev, Glushko, and Tsander had been put to the side for the time being, it is clear that the work at RNII was not only productive but also extremely important in terms of the later achievements of the Soviet rocketry program. Apart from the purely technological advancements and the mastery of important practical processes, the years at RNII also gave the young engineers their first active involvement in issues of organization and management. Although the political and social institutions under which they worked under were obviously vastly different, the work at RNII in many ways parallels that of the Germans and the Americans with their own amateur rocketry societies, which also attracted the interest of their respective governments. However, while all three independent early rocketry efforts in the late 1930s had to address the impending war, only one was to face the full brunt of the government's attack on its own people.

32. Vasili Mishin and Boris Raushenbakh. "The Scientific Legacy of Academician Sergei Korolyov." in *History of the USSR. New Research 5. Yuri Gagarin. To Mark the 25th Anniversary of the First Manned Space Flight* (Moscow: Institute of the History of Natural Science and Technology of the USSR Academy of Sciences, 1986). p. 106; Vetrov, S. P. *Korolev i kosmonavtika*, p. 80.

33. Peter Stache. *Soviet Rockets*. Foreign Technology Division Translation. FTD-ID(RS)T-0619-88 (from unnamed source). Wright-Patterson Air Force Base, Ohio, November 29, 1988, p. 206. This is a translation of Peter Stache. *Sowjetischer Raketen* (Berlin: Militärverlag der DDR, 1987). See also Mishin and Raushenbakh. "The Scientific Legacy," p. 106; Vetrov, S. P. *Korolev i kosmonavtika*, p. 89.

34. Lardier, *L'Astronautique Soviétique*, pp. 35-39. The high-altitude missiles included Objects 209, 609-1, RDD-604, and RAS-521. The winged missiles included Objects 48, 201, 212, 216, 217, and 218.

35. *Ibid.*, pp. 37-38, Glushko, *The Development of Rocketry and Space Technology*, p. 18. The original designation of the RP-318 was Object 218.

The Purges

All Soviet-era histories of early rocketry programs came to an abrupt end in 1937 when Stalin's Great Purges reached its zenith. The purges had a profound effect, not only on the scientific community but also on almost every other sector of Soviet society. Directed by the secret police—the People's Commissariat for Internal Affairs (NKVD)—and by Soviet leader I. V. Stalin's personal vision of suspicion, paranoia, and complete terrorization, the purges effectively decimated a whole generation of the Soviet Union's best engineers, writers, politicians, military officers, academics, and scientists. No one was safe at the time, however tenuous their ties to ideological trappings; people were picked up off the street for completely arbitrary reasons and never seen again. Not surprisingly, a feeling of paranoia crept into almost every level of society, fed by the suspicion and mistrust, as millions faced the threat of possible execution or internment in labor camps. "Informing" on an associate became less a compromise of one's value system than simply a means to live through the torture of NKVD agents.

RNII had been renamed the Scientific Research Institute No. 3 (NII-3) on January 2, 1937.³⁶ Within a year after that reorganization, the engineers of the institute were left with little doubt that their safety was no longer assured. The first effective indication that their luck had run out came in the late spring of 1937. The NKVD suddenly arrested Marshal Tukhachevskiy, the early patron of NII-3 and one of the more brilliant strategists of the Soviet military. on May 22, 1937. Recently appointed the commander of the Volga Military District, Tukhachevskiy was charged with having been part of an "anti-Soviet Trotskyite conspiracy." Interrogated and beaten savagely along with several other "accomplices" during the ensuing days, Tukhachevskiy was sentenced to death after a short trial. His sentence was carried out on June 12. Executed along with him were his mother, sister, and two brothers. Almost overnight, the name Tukhachevskiy became a dreaded word, and association with his name was a sure method of attracting suspicion. The marshal's links to NII-3 were not passed over by the NKVD, and the secret police seemingly put the entire group under surveillance, allegedly through the services of an ambitious communications specialist named Andrey G. Kostikov. Having joined NII-3 in 1934, Kostikov eventually became the prime motivator of the purges at the institute on behalf of the NKVD. Working with Clushko and others on liquid-propellant engines, Kostikov rose quickly through the ranks of NII-3; by mid-November 1937, he had become deputy director of the institute.

Kostikov's ascendance to power was preceded by the arrest of former NII-3 Director Kleymenov on the night of November 2 on charges of being a member of an anti-Soviet Trotskyite organization that had been part of a trade delegation to Germany.³⁸ Within days. Kleymenov's deputy Langemak was also arrested. Despite intense torture, the former refused to confess to any of the charges: Langemak, on the other hand, believing that he had a chance to save his life, broke under duress, and he confessed that Clushko had also been a member of the secret organization. Both were executed after signing false charges—Kleymenov on January 10, 1938. and Langemak the day after. Kostikov, meanwhile, continued to support the NKVD

36 Valeriy Zharkov "Pobedonostsevs Criteria" (English title) in Shcherbakov ed *Zagadki zvezdnykh ostrovov* p 73

37 Aleksey Khorev "How Tukhachevskiy Was Condemned The USSR State Security Committee Has Declassified Materials Related to the Conviction of Marshal of the Soviet Union Tukhachevskiy and the Other Military Leaders in 1937 The Archives Have Revealed the Documents on Their Execution and Cremation" (English title) *Krasnaya zvezda* April 17 1991 p 4

38 N L Anisimov and V G Oppokov "Incident at NII-3" (English title) *Voyenno istoricheskiy zhurnal* no 10 (October 1989) 81-87 Kleymenov had been removed from his post on August 30 1937

in their senseless vendetta, having provided fabricated evidence for the arrest of the two executed RNII leaders.³⁹

Kleymenov and Langemak were the first of many to pay a dear price because of their tenuous links to Tukhachevskiy. By the end of 1937, the NKVD had a statement denouncing Korolev and Clushko as "wreckers" of the rocket group—a statement probably extracted from Kleyrnenov and Langemak. This led to an expanded meeting on February 13, 1938, of the Scientific and Technical Council of the institute. One of the items on the agenda was the "denigration of the personality" of rocket engine designer Glushko.⁴⁰ He was charged with maintaining connections with "enemies of the people," disclosing military secrets, and avoiding public work. Officially, his accusers included Kleymenov and Langemak. On February 20, a second meeting was held, again to present more "evidence" against Clushko. All of Clushko's colleagues, save one, denounced him: Korolev was not present at this meeting. A resolution was adopted to the effect that Glushko was "unreliable," and a few days later, on March 23, 1938, he was arrested on charges of being an "enemy of the people."⁴¹

Following Glushko's arrest, the focus shifted to Korolev, certainly the leading NII-3 engineer at the time.⁴² Korolev himself publicly stated that he could not believe that Glushko had intentionally been involved in "wrecking" activities, only to arouse suspicions against him. At the time, Korolev was directing tests of Object 212, a winged surface-to-air missile, but these had to be temporarily suspended following a head injury on May 29, 1938, that left him hospitalized for a few weeks.⁴³ The NKVD, however, moved ahead with their agenda, and after several weeks of deliberations, on June 20, they formally denounced Korolev on charges of being a member of an anti-Soviet organization. The final piece of "evidence" against Korolev was a letter signed by four senior engineers at the institute denouncing Korolev of various disruptive activities.⁴⁴ The NKVD proffered five separate charges, including an accusation that Korolev had destroyed the RP-318 rocket-plane, even though at the time it sat quite intact in the hangar of the institute's headquarters. The denunciation also stated that both Korolev and Glushko had been "responsible for all errors, omissions, mistakes, and disruptions at the test stands."⁴⁵ Exactly a week later, on June 27, 1938, Korolev, barely recovered from his accident, was arrested and taken to the Lubyanka prison.⁴⁶ By all accounts, Korolev sincerely believed that his conviction and arrest was a bureaucratic mistake; it seems, however, that his distraught mother, Mariya N. Balanina, had realized the gravity of the situation and sent at least three letters addressed to Stalin himself pleading her son's innocence and expressing grave concern for his health.⁴⁷

39. The new director of NII-3, B. N. Slonirner, and the new deputy director, Kostikov, were formally appointed to their new positions less than two weeks after Kleymenov's arrest. See Golovanov, Korolev, p. 235.

40. Rebrov, "Specific Impulse."

41. Vetrov, 5 P Korolev i kosmonautika, pp. 121–22; Mikhail Rudenko. "O chem dymal zhyul vern." Trud, September 1, 1993, p. 3.

42. Korolev had been the senior engineer of Group No. 2 at NII-3 since January 1938.

43. Zharkov, "Pobedonostsev's Criteria," p. 76; Vetrov, 5 P Korolev i kosmonautika, p. 122.

44. Romanov and Cubarev, *Konstruktor*, pp. 48–49. Further biased evidence was supplied by investigators Bykov and Shestakov.

45. Rebrov, "Specific Impulse." For a detailed explanation of the charges against Korolev, see G. Vetrov. "In Difficult Years" (English title), *Aviatsiya i kosmonautika* no. 1 (January 1989): 36–37.

46. Anisimov and Oppokov, "Incident at NII-3." The order for Korolev's arrest was issued by the Chief Economic Directorate of the NKVD on the directive of First Deputy Chief Military Procurator C. K. Raginskiy, who himself was arrested in 1939. See B. A. Viktorov, "Restoration of Name" (English title), *Nauka i zhizn* no. 5 (May 1988): 78–82. Korolev was arrested under stipulation of article 58 of the RSFSR criminal code, points 7 and 11, which included charges of being "a member of an anti-Soviet underground counter-revolutionary organization."

47. The first two letters are reproduced in full in Anisimov and Oppokov, "Incident at NII-3," and were dated July 15 and July 22, 1938. An excerpt from the third, dated August 19, 1938, was published in Viktorov, "Restoration of Name."

Korolev was interrogated twice during this period. The first time he denied all charges. During the second occasion, after severe torture and beating, he "confessed" and signed a document implicating himself in the charges. Kostikov had also personally written a letter to the NKVD in July documenting Korolev's "anti-Soviet character." Combined with the false accusations from Kleymerov, Langemak, and Glushko, Korolev did not have to wait very long. On September 27, the Military Collegium of the USSR Supreme Court, under Vasiliy V. Ulrikh, sentenced Korolev to ten years in a "correctional labor camp." with a "deprivation of all rights" for five years and the confiscation of all personal property.⁴⁸ The second part of the sentence was merely a euphemism for hard labor at one of the many slave labor camps located throughout the Soviet Union: Korolev was to be sent to the Kolyma Arctic death camp at the Maldyak gold mine near Nagayev Bay in Siberia.⁴⁹ Korolev later said of the accusations against him:

During the investigation of my case, I could not prove or explain anything because there was no investigation in the proper sense of the word. I was bluntly accused of sabotaging research in new technology. I could not imagine a more absurd and incredible charge because the development of this new technology was the cause of my life and the work I loved."⁵⁰

Until his transfer to the labor camps, Korolev continued to make efforts to obtain a retrial. Put away at the Novocherkasskiy Prison in southern Russia, he wrote to Stalin himself in February 1939, pleading his innocence against the false charges.⁵¹

These letters most likely never reached Stalin's eyes and not surprisingly had little effect on Korolev's fate. There were, however, two factors that intersected in 1938-39 that saved Korolev's life. Soon after his imprisonment, a close friend of Korolev's, famed pilot Valentina S. Grizodubova, had joined forces with another famous Soviet aviator, Mikhail M. Gromov, and Korolev's own mother to author a letter to the Central Committee of the Communist Party requesting a review of Korolev's case.⁵² The statement apparently reached the office of Nikolay I. Yezhov, the chairman of the NKVD. Although Yezhov was abruptly arrested in November 1938, his successor, Lavrentiy P. Beriya, happened to have a particular interest in the Korolev case. Beriya would eventually make his reputation as one of the cruelest perpetrators of state terror in the Soviet Union, but when he assumed his new role in January 1939, he was more interested in cultivating an image of himself as a humane and fair person. After Beriya's appointment, prosecutor Ulrikh himself wrote to the NKVD to protest Korolev's original sentence. Prompted by the lobbying of Supreme Soviet members Grizodubova and Gromov, Beriya was convinced that Korolev was a good example to display his "humanity." Thus, at a special meeting of the Plenum of the High Court on June 13, 1939, the NKVD agreed to Ulrikh's protest and signed an order changing Korolev's official charge from a "member of an anti-Soviet counter-revolutionary organization" to the less serious "saboteur of military technology" and requested a new trial.⁵³

48 Vetrov S P Korolev i kosmonavtika p 122 Col M Rebrov 'The Leader Little Known Pages From the Life of S P Korolev' (English title) *Krasnaya zvezda* July 1 1989 p 4

49 Romanov and Cubarev *Konstruktor* pp 48-49

50 Mariya Pastukhova "Brighter Than Any Legend" (English title) *Ogonek* 49 (December 1987) 18-23 N Kidger 'Arrests Limited' Rocket Development ' letter to the editor *Spaceflight* 30 (1988) 169

51 Anisimov and Oppokov "Incident at NII 3 " Other letters were also allegedly written in August and October 1938 and April 1939 See Romanov *Korolev* p 158 Korolev was moved to Novocherkasskiy on October 10 1938

52 Viktorov 'Restoration of Name " At the time it was the All Union Communist Party (VKP) Gromov's status in the Soviet Union then was in many ways comparable to that of Charles Lindbergh's in the United States Gromov along with A B Yumashev had completed the first nonstop airplane flight from the Soviet Union to the United States in 1937

53 Ibid Romanov *Korolev* p 159

Unfortunately for Korolev, it was too late. Less than two weeks prior to the new order, on June 1, he had already started his journey to the Kolyma camp.⁵⁴ He traveled by rail in an overcrowded cattle car across the Ural and Baykal mountain ranges before being transported in the hold of a ship along with hundreds of other prisoners across the Sea of Okhotsk. Korolev arrived at Kolyma in August 1939. Given the conditions at the camp, it would have been surprising if he ever believed he would leave it alive. He worked as an Earth digger in a gold mine off the Kolyma River for the ensuing months. It was well known even at the time that of all labor camps of the GULag system, Kolyma was the most brutal and cruel." During operations throughout World War II, the camp claimed the lives of between 2 and 3 million people. Most of the deaths were from overwork, famine, cruelty from the guards, and the harsh Arctic climate. In the first months, Korolev was so brutally treated that he was left with a huge scar on his head and lost half his teeth from scurvy. He also had the misfortune of arriving at Kolyma during one of the worst winters in its entire history of operations. Despite the inhuman conditions at Kolyma, Korolev continued to make efforts to deny his guilt. In a letter dated October 15, he wrote to the Soviet Union's chief procurator demanding his immediate return to Moscow.⁵⁵ Addressed to Andrey Yu. Vyshinskiy, the powerful lawyer and diplomat who was personally responsible for sending thousands to their deaths, Korolev wrote. "I have been foully slandered by the institute director, Kleymenov, his deputy, Langemak, and engineer Clushko." He was apparently unaware that Kleymenov and Langemak had been executed."

Clushko meanwhile had been sentenced in absentia to eight years in prison on August 15, 1939, during a special session of the NKVD. They sent him to a prison for scientists and engineers in Tushino near Moscow, part of a larger network of prisons that specifically held the scientific intelligentsia of the country." The inmates referred to such prisons as *sharashka*, a word deriving from the Russian slang expression meaning a "sinister enterprise based on bluff or deceit." Of the other major individuals at NII-3, both Tikhonravov and Pobedonostsev, for reasons unclear, escaped hardship, and they remained behind to work at a revamped NII-3. In November 1937, the institute had been transferred to the Commissariat for Ammunitions, the "ministry" responsible for the production of a variety of artillery weapons systems." This change also presaged a major thematic restructuring in the direction of work at NII-3 as Kostikov was appointed director of the institute in late 1939. Most of the post-purge efforts at NII-3 were focused on the development of launch equipment and solid-fuel missiles for use by the artillery forces. Some work on earlier projects, such as Korolev's Z12 missile and the RP-318 rocket-plane, was allowed to continue, but it is clear that there was a significant turn in research at the institute—one that effectively stilted many years of fruitful work.

54. Golovanov, Korolev, p. 264.

55. GULag is the Russian acronym for Chief Directorate of Camps.

56. Vetrov, *S. P. Korolev i kosmonautika*, pp. 126–30; Pastukhova, "Brighter Than Any Legend." An earlier letter to Stalin was dated August 13, 1939.

57. German Nazarov, "You Cannot Paper Space With Rubles. How to Save Billions" (English title), *Molodaya guardiya* no. 5 (April 1990): 192–207.

58. In fact, as late as July 1940, Korolev was still in the dark about their fate.

59. This was Plant No. 82. Initially, Clushko worked under a section headed by the noted aeronautical engineer B. S. Stechkin. See Boris Katargin and Leonid Sternin, "Pushing Back the Missile Technology Frontiers," *Aerospace Journal* no. 5 (September-October 1997): 88–90; N. L. Anisimov and V. G. Oppokov, "Incident at NII-3: II" (English title), *Voyenno-istoricheskii zhurnal* no. 11 (November 1989): 65–71.

60. Aleksandr Solzhentstyn, *The first Circle* (New York: Harper & Row, 1958), p. ix, referenced in James Harford, *Korolev: How One Man Masterminded the Soviet Drive to Beat America to the Moon* (New York: John Wiley & Sons, Inc., 1997), p. 57.

61. Lardier, *L'Astronautique Soviétique*, p. 44. Another source suggests that this transfer occurred in 1940. See B. Ye. Chertok, *Rakety i lyudi* (Moscow: Mashinostroyeniye, 1994), p. 35.

Beriya's change-of-heart in 1939 prompted officials to search out Korolev in the camps. After what must certainly have been the most torturous period of his life, in December 1939, the starved Korolev was located at Kolyma and put on a train back to Moscow. Of the 600 individuals who had been at the camp when Korolev had arrived, only 200 remained alive when he left. In Khabarovsk in the Soviet far east, he received medical attention for the first time and eventually ended up in Moscow on March 2, 1940, incarcerated in cell number 66 at the notorious Butyrskiy Prison, one of the more physically and psychologically degrading facilities of the GULag system." Soon after, the NKVD, under Beriya's watchful eye, undertook an investigation into Korolev's case, which concluded on May 28, 1940. The secret police handed down its sentence more than a month later on July 10, effectively sealing Korolev's fate for several years: the official sentence stated the Korolev would be "deprived of his freedoms" for the next eight years." Although the verdict saved him from another trip to the death camps, it was another cruel blow for Korolev. Once again, he wrote several letters to Stalin, Beriya, and the chief procurator in the following months.⁶⁴ It was clear that he was not willing to give up on his plight.

While his lobbying efforts may not have had an effect on his imprisonment, an unrelated event at the time would eventually save Korolev from the trials of the Butyrskiy Prison. Famous Soviet aircraft designer Andrey N. Tupolev had also been incarcerated during the purges in October 1937. He had been sent off first to Moscow's dreaded Lubyanka Prison and then soon to the slightly "better" Butyrskiy facility also in Moscow." Perhaps because of the impending war effort, Stalin apparently took a personal interest in those who had worked or studied under Tupolev. Stalin ordered Tupolev to prepare a list of individuals who could be useful for in support of the aeronautical industries. One of those on the list of twenty-five was Korolev, who had studied under Tupolev as a young college student." Thus in September 1940, Korolev was transferred from Butyrskiy to a newly formed aviation design bureau located in Stakhanov village near Moscow under Tupolev's nominal command. The facility remained under the direct control of the 4th Special Department (for new technology) of the NKVD.⁶⁷ Officially designated the Central Design Bureau No. 29 (TsKB-29), the plant was another of the *sharashka* system, with all the engineers serving as prisoners of the Soviet state. The inmates were housed in a special prison with barracks and were guarded at all times. One of those who was also incarcerated at TsKB-29 recalled his own arrival at the *sharashka*:

We were taken to the dining room . . . heads turned to our direction, sudden exclamations, people ran to us. There were so many well-known, friendly faces. At the tables we can see A. N. Tupolev, V. M. Petliakov, V. M. Myasishchev, I. G. Neman, S. P. Korolev, A. I. Putilov, V. A. Chizhevskiy, A. M. Cheremukhin, D. S. Makarov, N. I. Vazhenkov — the elite, the cream of Russian aircraft technology. . . . It was impossible to conceive that they had all been arrested, and they were all prisoners — this meant a catastrophe for Soviet aviation!⁶⁸

62 Vetrov 5 P Korolev i kosmonavtika p 123

63 Anisimov and Oppokov "Incident at NII 3 II"

64 The letter dated July 13, 1940 to Stalin and the documents dated July 23 to the chief procurator and Beriya and September 13 to the chief procurator are reproduced in full in *ibid*

65 Robert Conquest The Great Terror A Reassessment (New York Oxford University Press 1990) p 295

66 There are differing accounts as to how many names were actually on this alleged list. For example, one fellow prisoner whose name was also on the same list, L. L. Kerber, recounted in 1991 that there were 200 names on Tupolev's list. See Harford Korolev p 59. See also A. Romanov "Force of Spirit" (English title), Trud February 26, 1988 p 3, in which S. M. Yeger, another prisoner, claims that twenty-five people were on the list.

67 Vetrov 5 P Korolev i kosmonavtika p 125 Romanov and Cubarev Konstruktory pp 50-51 Romanov Korolev p 160

68 A. Sharagin Tupoleuskaya *Sharaga* (Frankfurt Georgi Aleksandrovich Ozerov 1971) pp 13-14. A slightly different translation is used in McDougall *the Heavens and the Earth* p 38.

Prisoners of War

The beginning of World War II was an unexpected blow for the Soviet Union. The German invaders advanced rapidly over Soviet territory toward the major cities of the nation. While the Great Purges had been a tragic setback for Soviet rocketry, the war provided an unexpected setting for the organization of sporadic and disparate rocketry efforts that trained and gave experience to a new generation of engineers weaned on wartime conditions. In the initial period of the war, none of the efforts were directed toward anything more than modest solid-fuel rockets for use on either aircraft or as short-range artillery weapons.

For Korolev, the work at TsKB-29 was a far cry from his earlier goals. The primary thematic work of the group was the quick fruition of project 103 to build a military bomber designated the Tu-2.⁶⁹ The bomber eventually went into operation in October 1942, and it was then that the NKVD acted on Korolev's repeated requests to be transferred to work on rocket engines. In November, Korolev was moved to a special design bureau working at Aviation Plant No. 16 in Kazan." This facility was also part of the NKVD prison system and effectively operated by the secret police. It comprised several subordinate teams working on different problems. By coincidence, one of these groups, Design Bureau No. 2, was headed by none other than Korolev's former NII-3 associate Glushko. The latter had spent the immediate prewar years in Tushino working for ramjet specialist Boris S. Stechkin before being moved to Kazan in 1940. The primary goal at the design bureau in Kazan was to develop auxiliary liquid-propellant rocket engines to assist in the takeoff phases of a variety of propeller-driven aircraft. Korolev himself was appointed chief of Group No. 5 in charge of reactive units in January 1943." Thus, about five years after his arrest, Korolev eventually found his way back into the design of liquid-propellant rocket engines, although clearly it was not with the same goals in mind as RNII or GIRD had proposed years before.

While few personal details are available of Korolev's time at the Kolyma mines, his years at the Tupolev prison and at Plant No. 16 in Kazan have been better documented. The first impressions of those who saw Korolev after he first arrived to work for Tupolev were not encouraging. Another prisoner recalled:

He [Korolev] looked terrible. He was emaciated and exhausted. Tupolev showed a lot of care in his relationship with Korolev which we could not understand. Apparently, he valued qualities of Korolev that we did not notice at the time. He was industrious, responsible, and had an interest in creative solutions."

The NKVD never really relinquished their hold on Korolev. Legend has it that their agents told Korolev, upon arrival at the Tupolev sharashka, that "our country doesn't need your fireworks. Or maybe you're making rockets for an attempt on the life on our leader?" There are reports that Korolev was "absolutely firm, never disguising his contempt for the regime."

69 Yuriy Biryukov and Vikentiy Kornarov. "S. P. Korolev in the 'Sharashka'" (English title). In Shcherbakov, ed., *Zagadki zvezdnykh ostrovov*, p. 103. The airplane flew its first flight in January 1941. Because of the rapid advance of Germans into Soviet territory, TsKB-29 itself was moved in July of that year to a different location at Plant No. 166 in Irtysh, near Kulomzino in the Omsk region. See Biryukov and Kornarov. "S. P. Korolev in the 'Sharashka'." p. 103, Lardier, *L'Astronautique Soviétique*, p. 46.

70. Biryukov and Kornarov. "S. P. Korolev in the 'Sharashka'." p. 104: Romanov and Cubarev, *Konstruktor*, p. 53

71 Biryukov and Kornarov. "S. P. Korolev in the 'Sharashka'." p. 105

72 Rebrov, "The Leader" The associate was S. M. Yeger

73 Conquest. *The Great Terror*, p. 294.

74. James E. Oberg. "Korolev and Khrushchev and Sputnik." *Spaceflight* 20 (April 1978): 144-50

Professor Georgiy A. Ozerov, a Soviet engineer who knew Korolev in the *sharashka*, described him as "a cynic and a pessimist who took the gloomiest view of the future." One of Tupolev's deputies also recalled later that Korolev's favorite phrase in prison was "we will all vanish without a trace." Apparently, he was very contemptuous of the regime and fully expected to be shot. Others say that Korolev never doubted the "honesty and sense of justice" of Stalin.⁷⁵ This is partly borne out by his letters addressed to Stalin from both Kolyma and the Butyrskiy Prison. It seems that only after the denunciations by Khrushchev in 1956 did Korolev realize the magnitude of Stalin's ruthlessness during the purges. A fellow prisoner of Korolev's at the NKVD prison, Esfir M. Rachevskaya, relayed one particularly touching anecdote. She recalled later how one day the radio was playing Aram Khachaturyan's violin concerto:

I felt homesick. I wanted to be back home, in Moscow, with my family and friends. Tears ran down my cheeks, and I looked round to see Korolev standing beside me with tears in his eyes too. After looking at him, I began to cry most bitterly. He went back into the office, and when I returned, he was sitting at his desk absorbed in his work."

The Presidium of the Supreme Soviet, no doubt on orders from the NKVD, signed an official order (protocol no. 18) on July 27, 1944, officially releasing both Glushko and Korolev from confinement." They were among a group of thirty-five engineers freed at the time, cited for their "contribution in building aircraft jet boosters." The effects of the decree went into effect on August 10, but it is clear that given the wartime conditions and the continuing threatening nature of the NKVD, little changed in either of their lives. In fact, both Korolev and Glushko still officially remained convicts of the Soviet state because their original sentences were not overturned. With their release, Glushko's group, Design Bureau No. 2 of Plant No. 16, was officially moved from under the jurisdiction of the NKVD to the aviation industry and renamed the Special Design Bureau for Special Engines (OKB-SD). Glushko was appointed the chief designer and Korolev his deputy. The irony of Korolev's position as Glushko's deputy was not lost on either as their positions had been effectively reversed from the days of RNII in the 1930s.

Still focused more on aviation applications than pure rocketry, all of the work at this location was dedicated to the use of liquid-propellant rocket engines, such as the RD-1KhZ, RD-2, and RD-3, on Soviet fighter planes designed by Lavochkin, Sukhoy, and Yakovlev.⁷⁶ In his new state of "freedom" and as the deputy chief designer of OKB-SD, Korolev apparently made an attempt to interest the leaders of the aviation industry in long-range missiles. On October 14, 1944, just over two months after his release, he submitted a report to First Deputy People's Commissar of Aviation Industry Petr V. Dementyev on the possibility of developing two long-range missiles fueled by solid propellants. Both of these, the unguided ballistic D-1 and the winged guided D-2, used elements of a prewar missile named the 217, which had been the

75 Leonid Vladimirov *The Russian Space Bluff* (New York: The Dial Press, 1973) p. 146. Vetrov, S. P. *Korolev i kosmonautika* p. 135. The deputy was L. L. Kerber.

76 Pastukhova, 'Brighter Than Any Legend.'

77 V. Lysenko, ed., *Three Paces Beyond the Horizon* (Moscow: Mir Publishers, 1989) pp. 33-34. See also A. Yu. Ishlinskiy, ed., *Akademik S. P. Korolev: ucheny i inzhener chelovek* (Moscow: Nauka, 1986) p. 141.

78 Romanov, *Korolev* pp. 192-93.

79 Katorgin and Sternin, 'Pushing Back the Missile Technology Frontiers.'

80 Biryukov and Kornarov, 'S. P. Korolev in the Sharashka' pp. 106-07. When NII I was formed in May 1944, Glushko's design bureau may have been subsumed as part of the NII I system as a sector in the institute. See C. Wachtel, 'The Chief Designers of the Soviet Space Program,' *Journal of the British Interplanetary Society* 38 (1985) 561-63. Lardier, *L'Astronautique Soviétique* p. 62.

81 A good summary of the work at OKB SD is provided in Vetrov, S. P. *Korolev i kosmonautika* pp. 157-74.

focus of work at NII-3. The proposed ranges of the vehicles were, respectively, sixty and a half kilometers and 115 kilometers." The missiles had capabilities comparable to the German A-4 but were obviously derived from different antecedents. In a clear indication of Korolev's long-dormant dreams, he even proposed using the D-2 for "manned flight."

In submitting a later report on the D-1 and D-2 in December 1944, Korolev laid down a specific timetable for the development of the two vehicles, emphasizing their military utility. Korolev did not understate the required leap of technology and management required for such a project, adding that: "The tasks we face are immense and the altitudes we want to reach are such as our predecessors and teachers of the pioneer days . . . could only dream. . . ." ⁸² As the war raced to a close in early 1945, Korolev was allowed to work on a second version of the D-1/D-2 project draft, although much if not all the work at the OKB-SD remained focused on rocket accelerators for airplanes. It seems that the leadership of the aviation industry had little interest in involving itself in the development of ballistic missiles, an attitude that eventually put the early postwar Soviet efforts in rocketry firmly in the hands of a resourceful group of artillery people.

The work at OKB-SD may have given refuge to a beleaguered Korolev, but the most important Soviet liquid-propellant rocketry research was carried out elsewhere, in a new institute formed in 1944 by combining the efforts of two other aeronautical and rocketry organizations. The first of these was Kostikov's NII-3, which during the early part of the war developed missiles for the famous Katyusha system to which most Russian historians continue to refer in almost mythical terms." On July 15, 1942, the aviation industry took control of NII-3 at the same time that Kostikov's rising star reached its zenith. Having gained innumerable honors in his rise to power, Kostikov was suddenly arrested on March 15, 1944, on charges of deceiving the Soviet government and Stalin personally in connection with a rocket plane project." By this time, aviation industry leaders had formulated a plan to merge NII-3, now renamed the State Institute for Reactive Technology, with a second organization.

This second entity had been formed in Moscow in the mid-1930s as a small aircraft design bureau under the leadership of Viktor F. Bolkhovitinov. After relocating in 1937 to Kazan, two years later, the group settled down at Khirniki as the Special Design Bureau of Plant No. 293. By 1944, the team, made up mostly of young talented engineers, had developed one of the first Soviet rocket planes, the BI-1, and they were moving on to more advanced designs.⁸³ Among this group were Aleksandr Ya. Bereznyak, Konstantin D. Bushuyev, Boris Ye. Chertok, Aleksey M. Isayev, Mikhail V. Melnikov, Vasilii P. Mishin, and Arvid V. Pallo—individuals who would all eventually play critical roles in the emergence of the Soviet space program in the 1950s and 1960s. To consolidate scarce resources during the war, the aviation industry signed a merger decision on May 29, 1944, which effectively united the old NII-3 and Bolkhovitinov's team into a new institute designated Scientific Research Institute No. 1 (NII-1).⁸⁷ Maj. General Petr I.

82. *Ibid.*, pp. 178-85, Biryukov and Komarov. "S. P. Korolev in the 'Sharashka'." p. 108. The ranges were thirty-two and seventy-six kilometers, respectively, in the initial draft of the project.

83. Stache, *Soviet Rockets*, p. 162.

84. Riabchikov, *Russians in Space*, pp. 135-36. The RS-82 and RS-182 missiles designed by the executed Langemak were used as a basis to design the Katyusha rockets, although Kostikov apparently took credit for their genesis.

85. Anisimov and Oppokov, "Incident at NII-3"; Romanov and Cubarev, *Konstruktor*, p. 46; Lardier, *L'Astronautique Soviétique*, p. 46; Vetrov, *S. P. Korolev i kosmonautika*, p. 141.

86. Riabchikov, *Russians in Space*, p. 134; Chertok, *Rakety i lyudi*, pp. 18-21.

87. Chertok, *Rakety i lyudi*, p. 144; Lardier, *L'Astronautique Soviétique*, p. 61; Wachtel, "The Chief Designers of the Soviet Space Program." The old NII-3 (known as GIRT since July 15, 1942) was originally reorganized into the Scientific-Research Institute for Reactive Aviation (NII RA) on February 18, 1944. The same NII RA was then combined with Bolkhovitinov's Plant No. 293 later on May 29 of the same year to become NII-1. See Rostislav Angelskiy, ". . . And if not Korolev?" (English title), *Aviatsiya i kosmonautika: uchera, segodnya, zavtra* no. 4 (1998): 22-26.

Fedorov, the former deputy director of a major research institute in the Soviet Air Force, was appointed the first director of NII-1, with Bolkhovitinov as his deputy. Fedorov established at least five sections in the new institute, three of which were exclusively dedicated to the development of liquid-propellant rocket engines for use on military aircraft. Although the thematic direction of the work at the new NII-1 was little different from that of its component organizations, the unification served as a means to bring some order into the somewhat chaotic rocketry efforts during World War II.

Raketa

The Soviet leadership in 1944 had no interest in creating a program for the development of ballistic missiles in support of the war effort. Despite this lack of enthusiasm for indigenous efforts, there was considerable interest in acquiring and studying concurrent German rocket technology. Without a doubt, the most technologically sophisticated and advanced rocketry program during the war existed in neither the United States nor the Soviet Union, but at Peenemünde in Germany under the administrative leadership of General Walter Dornberger. With the young Wernher von Braun as the technical head of operations, Dornberger's group of highly talented individuals had, by the end of the war, developed one of the most feared weapons of World War II, the A-4 ballistic missile. More commonly known as the V-2, or "vengeance weapon," in German, the A-4 performed its first successful launch on October 3, 1942, after three failures in March, June, and August of the same year. With a maximum range of about 300 kilometers and a capability to reach altitudes of close to ninety kilometers, the A-4 was produced in the thousands by slave labor in the latter part of the war as almost a last-gasp attempt by the Nazis to turn the inevitable course of the war. A second weapon, the Fieseler Fi-103 "flying bomb," also known as the V-1, was part of this intense German campaign to numb Great Britain into submission. Although casualties were relatively low compared to aerial bombing, the specter of the two missiles produced an unimaginable sense of terror among the mostly civilian victims.

In a letter dated July 13, 1944, British Prime Minister Winston Churchill personally requested Stalin's cooperation in locating and retrieving A-4 and Fi-103 production materials that the Germans were leaving behind with their retreat.⁸⁸ Churchill's prime concern was that British intelligence officers be allowed to inspect and examine any captured A-4 components from the experimental missile station at Debica near Krakow in Poland, which, by July 1944, was only about fifty kilometers from the Soviet frontlines. As they began their retreat in mid-1944, the Germans had, however, done a fairly good job of destroying all possible remnants of their research.

Stalin ordered the formation of a secret expeditionary group of Soviet specialists to investigate the remains at Debica. People's Commissar of Aviation Industry Aleksey I. Shakhurin tapped the NII-1 organization to help set up an advance team. Under the watchful eye of the NKVD, on August 5, Maj. General Fedorov led a small group of NII-1 engineers, including Korolev's old RNII associates Tikhonravov and Pobedonostsev, to Debica.⁸⁹ Initially, the Soviet team collected some interesting parts, such as an A-4 combustion chamber and parts of propellant tanks, before allowing British teams to enter a week later to conduct their own investigations. Highly accurate aerial maps prepared by the latter were instrumental in locating more fallen A-4 debris from test firings that the Germans had conducted. Recovered parts from the missile were soon loaded into

⁸⁸ The complete text of this letter is reproduced in Chertok *Rakety i lyudi* pp 86-87

⁸⁹ Ibid pp 87-88. Yu P Semenov ed *Raketno Kosmicheskaya Korporatsiya "Energiya" imeni S P Koroleva* (Korolev RKK Energiya named after S P Korolev 1996) p 18. Others going to Debica were N G Chernyshov R Ye Sorokin M Ye Shekhtman and Yu A Fedosyuk

Li-2 transport aircraft and returned to Moscow under tight NKVD security. Upon return to Moscow, with the exception of NII-1 Director Fedorov and Deputy Director Bolkhovitinov, almost all the employees of NII-1 were kept in the dark about the entire operation. Eventually, the NKVD loosened some of their restrictions, and Bolkhovitinov was ordered to establish a very small group of talented engineers to study the engineering aspects of the A-4. This section of A-4 researchers was given the top-secret designation *Raketa*, the Russian word for "missile," and included RNII veterans Tikhonravov and Pobedonostsev. Plant No. 293 alumni Bereznyak, Bushuyev, Chertok, Isayev, and Mishin, and newcomers Nikolay A. Pilyugin and Leonid A. Voskresenskiy.⁹⁰

Possibly the youngest of the group was Vasily Pavlovich Mishin, a specialist in control systems who, twenty years later, would lead the Soviet program to land a cosmonaut on the Moon. He was born on January 5, 1917, in the village of Byualino not far from Moscow. His brother and sister died in childhood, and his family disintegrated soon after. The young Mishin was raised by his grandfather because his father had been jailed for several years for not informing on a person who had told a joke about Stalin. After his father's release, Mishin moved to Moscow and qualified as one of the lucky entrants into the prestigious Moscow Aviation Institute in 1935. He was 18 at the time and apparently considered a very bright student. There, Mishin did his prediploma work under the aircraft designer Bolkhovitinov. Passionately in love with flying, Mishin was also well known as one of the first pilots in the Soviet Union to master a "self-starting" piloting technique without outside assistance. Later in 1940, he was called up for work at Bolkhovitinov's Plant No. 293 and took part in the development of the one of the world's first rocket-powered airplanes, the BI-1, which flew successfully in 1942.⁹¹ Mishin was one of many of Bolkhovitinov's engineers transferred to NII-1 in early 1944, and after the A-4 fragments were recovered in August, he became one of the leading members of the group. Equipped with a very assertive personality, he was instrumental in extracting important information on the workings of the German missile from the few scraps that were recovered. Because of his father's "suspect" background, Mishin was apparently considered somewhat of a state risk and was not allowed to travel anywhere without permission.

The primary goals of the 1944 recovery operations were to determine whether the possibility existed of creating an analog of the A-4 weapon in Soviet industry. It seems that the evaluation team was actually organized on two different levels. While the *Raketa* group at NII-1 was kept busy with a technical investigation of the recovered remains, a second group was tapped to advise Stalin and the Soviet leadership on the possible uses of such weapons—that is, their utility in wartime conditions. This process was the catalyst for introducing a second group of individuals, the artillery officers, who would play a very significant role in the future development and operation of the Soviet space program.

In the late summer of 1944, the Chief of Staff of the Third Army's Katyusha Rocket Launcher Unit Operations Group, Major Georgiy A. Tyulin, was recalled from his duties for a top secret assignment.⁹² A thirty-year-old officer serving in the Chief Artillery Directorate, Tyulin had studied at the aerodynamics laboratory at Moscow State University in the late 1930s and, since 1941, had been one of the leading experts in handling rocket operations. His reassignment led him to a top secret scientific and technical division headed by a Lt. Colonel Anatoly

90. Romanov and Gubarev, *Konstruktory*, p. 57; Romanov, *Korolev*, pp. 203–04; Chertok, *Rakety i lyudi*, p. 88. Others in the *Raketa* group were Bordachev, A. A. Borovkov, I. F. Florov, and Yu. A. Kononov.

91. A. Tarasov, "Missions in Dreams and Reality" (English title), *Pravda*, October 20, 1989, p. 4, Mikhail Rebrov, "The Last Argument. A Study of the Designer in Black and White" (English title), *Krasnaya zvezda*, March 25, 1995, p. 6.

92. Lt. Gen (Ret.) G. Tyulin, "The 'Seven' Years, Accomplishments, People" (English title), *Krasnaya zvezda*, April 1, 1989, pp. 3–4.

I. Semenov, under whose leadership he was to study captured German Fi-103 and A-4 missiles. The entire effort was coordinated by the Communist Party through the auspices of Maj. General Lev M. Gaydukov, a member of the Military Council of the Mortar Guards Unit and simultaneously chief of the Party Central Committee's department for artillery affairs.⁹³

It is not clear whether the NII-1 Raketa group had any significant personal interaction with artillery officers Tyulin or Semenov, but clearly their individual findings were coordinated. According to Tyulin, he was to "thoroughly study models of German field rocket artillery, large quantities of which were available at the captured ammunition depots, and to prepare proposals on developing future rocket systems."⁹⁴ In studying the Fi-103 cruise missile, Tyulin was evidently not impressed with its wartime capabilities and concluded that it would not be worthwhile to engage in immediately developing a replica of the vehicle. His reasoning may have stemmed from its slow speed and vulnerability to anti-aircraft defenses. On the other hand, it seems Tyulin had been far more impressed with the A-4. On developing some vision of future military strategy, Tyulin's assessments may have been limited by the minuscule knowledge about the A-4 available to the Soviets at the time. At one early meeting with his superior, he was asked what his group had learned about the missile: Tyulin recalled saying that "we know practically nothing about the [A-4] missile except that it flies."⁹⁵ By late 1944, Semenov and Tyulin prepared a recommendation for Maj. General Gaydukov that called for heightened efforts to capture as much A-4 materials as possible; they strongly emphasized the importance of such weapons for the artillery sector in wartime conditions.

In the NII-1 Raketa group, work on reconstituting the A-4 progressed slowly at first but began to pick up pace by the end of 1944. Engineer Isayev later recalled that:

In the summer of 1944 a pile of bent steel, broken glass, electrical cable, and battered housing, filled with electronic devices, was brought into the conference room of our institute. . . . For the next two months the conference room became a laboratory where designers reconstructed the Hitlerite "wonder weapon" from broken pieces of sheet metal, aluminum, and electron tubes. . . .⁹⁶

Mishin added: "We quickly traced out from the pieces the layout of the rockets and the pneumatic systems, and calculated trajectories; our mathematician, Yuriy Kononov, was outstanding in this task."⁹⁷ What the Soviets extrapolated from the recovered debris stunned the members of the Raketa group. The capabilities of the A-4 were far in advance of any missile produced or even planned by the Soviets during the war. Swallowing their collective pride, in two months, Raketa head Bolkhovitinov was able to produce a lengthy report on their findings and submitted it officially to his bosses. Commissar of the Aviation Industry Shakhurin and his First Deputy Dementyev.⁹⁸ Bolkhovitinov's recommendations were clear: efforts should be made to reconstitute and recreate the German A-4 missile, while at the same time creating a modernized version for the military. Unfortunately for those at NII-1 and the aviation industry in general, neither Shakhurin nor Dementyev were particularly interested in putting resources into developing missiles. Both apparently were perfectly happy to let the People's Commissariat of Ammunitions do that job, given that the latter sector had manufactured the literally thousands of solid-fuel Katyushas that the Soviets had used to terrorize the Nazis. Shakhurin did not make

93 For Gaydukov's posts see Chertok *Rakety i lyudi* pp 123-24 Lardier *L'Astronautique Soviétique* p 49

94 Tyulin "The Seven "

95 *Ibid*

96 Stache *Soviet Rockets* p 168

97 Tarasov "Missions in Dreams and Reality "

98 Carl Fredrik Geust *Under the Red Star* (Shrewsbury UK Airline 1993) p 114

the decision blindly. He apparently called together a meeting of the most prominent Soviet aviation designers, such as Tupolev, Yakovlev, Mikoyan, and Lavochkin, to hear their recommendations on the issue. Not surprisingly, none believed that rockets had any utility as military weapons in the near future: fighters and bombers would do fine for now.⁹⁹ Shakhurin dissolved the Raketa team in November and put them back into their earlier work. This decision was apparently taken very hard by Bolkhovitinov's team, and he, "at his own risk," instructed Mishin to continue calculations on the A-4 missile based on the analysis of recovered parts.¹⁰⁰

There was a short resurgence of interest in early 1945, when information was received at the institute that additional pieces had been located at Debica. To investigate, a second team, this one headed by NII-1 Director Maj. General Fedorov, left Moscow on February 7, 1945. Unfortunately, over Kiev, the aircraft lost control and crashed, killing all twelve crew members and passengers on board. Mishin was supposed to be on the flight, but at the last minute Soviet security officials did not allow him to board the aircraft, replacing him with engineer Aleksey A. Borovkov. The secret police believed that he would be a security risk because his father had an unfavorable prison record.¹⁰¹

Shakhurin's rejection of the possible uses of the A-4 missile in late 1944 eventually had significant repercussions for the institutional backdrop of the Soviet space program. Twenty years in the future, the Soviet Air Force would pay the price for Shakhurin and Dementyev's decision to stay out of missiles. While not interested in the A-4, Shakhurin was, however, much more attracted to the capabilities of the Fi-103 cruise missile. Perhaps because of its physical similarity to aircraft, Shakhurin and Dementyev believed that this weapon held greater promise. This interest in the cruise missile helped start the third wartime rocketry effort, other than Glushko's OKB-SD and Bolkhovitinov's NII-1—one to reproduce the German Fi-103. The job went to a brilliant thirty-year-old mathematician named Vladimir Nikolayevich Chelomey, whose later role as one of the powerhouses of the Soviet space program would be the stuff of legends.

Born on June 30, 1914, in the small Ukrainian town of Sedlets, Chelomey graduated from the Kiev Aviation Institute in 1937—the same institute at which Korolev had studied in the mid-1920s. He was an exceptionally gifted student. As an undergraduate, Chelomey published his first textbook on vector analysis, and in 1938 alone, he published fourteen articles on mathematics in the official journal of the Kiev Aviation Institute. In 1939, he defended his master's dissertation at the Institute of Mathematics at Kiev. Based on his remarkable intellectual gifts, Chelomey was selected as one of fifty of the most promising students in the Soviet Union and entered a special postgraduate program soon after. By 1941, he was a sector chief at the P. I. Baranov Central Institute of Aviation Engine Building and began some fairly important work on the development of pulse-jet engines—research that in many ways paralleled that of the Germans on the Fi-103 missile. Unaware of the German work, Chelomey had proposed the development of a pulse-jet cruise missile in 1943, but his idea had been rejected at the time. Later in 1944, Stalin had called in Shakhurin and Air Force Commander-in-Chief Marshal Aleksandr A. Novikov and ordered them to start a crash program to develop an analog of the German missile. On the night of June 13, 1944, at a meeting of the State Committee for War

99. Mikhail Rebrov, "Plans That Failed to Live up to Hopes, or No Prophets in Our Fatherland" (English title), *Krasnaya zvezda*, December 27, 1997, p. 6.

100. B. Kononov, "From Germany to Kapustin Yar" (English title), *Izvestiya*, April 6, 1991, p. 3. See also Boris Kononov, *Tayna Sovetskogo raketnogo oruzhiya* (Moscow: ZEVS, 1992), p. 7.

101. Tarasov, "Missions in Dreams and Reality": Chertok, Rakety i lyudi, p. 89; Lardier, *L'Astronautique Soviétique*, pp. 61–62. Among those killed were Raketa veterans A. A. Borovkov and Yu. V. Kononov, solid-propellant specialist L. E. Shvarts, and NII-1 Sector Heads S. I. Dementyev and R. I. Popov. NII-1 Director Fedorov was replaced by Ya. L. Bibikov.

attended by Shakhurin and Novikov, Stalin signed an order for Chelomey to proceed with work on creating a long-range winged missile using a pulse-jet engine." Chelomey received all the facilities he needed, on October 19, he was officially appointed chief designer at Plant No. 51 of a design bureau that had been headed by the recently killed famous aviation designer Nikolay N. Polikarpov.¹⁰³

It seems Chelomey that had enacted a very accelerated program and went through ten different design configurations before settling on a missile that was quite similar to the German Fi-103. Designated the IOX. Chelomey directed sixty-three launches of the missile between March and August 1945.¹⁰⁴ Air-launched from the Pe-8 bomber, the tests produced modest results, and there was little hope that the missile could be used actively in battle during the waning days of the war. In March 1945, Chelomey was summoned to the presence of Stalin and Beriya to discuss the future of the missile. In a moment of tension, Beriya bluntly asked Chelomey whether he had appropriated the design of the IOX from the German Fi-103. Chelomey replied, "I obviously could not have borrowed their ideas. Whether the Germans [stole] my ideas is a question for you. Lavrentiy Pavlovich." It was a typically fearless response from Chelomey, and such ambition and assertiveness would eventually posit him as one of the major players in the early Soviet space program. As for the IOX missile, in the end it did not produce very encouraging results, although Chelomey continued to pursue the work by upgrading the performance characteristics of the rocket. Meanwhile, by late 1945, the Soviets had captured the remains of the German Fi-103, and the Fi-103's clear superiority to the IOX may have prompted Chelomey to rethink his future plans.¹⁰⁶

Chelomey's work at OKB-51 was the third major Soviet rocketry effort during the war. It seems that all three groups—NII-1, OKB-SD, and OKB-51—worked fairly independently of each other, despite the fact that from 1944, all were employed by the same "ministry," the People's Commissariat of Aviation Industry. Clearly none of the design bureaus conducted any major work on long-range ballistic missiles, the necessary prerequisite to the early space program. It would, in fact, take firsthand experience with the remains of the German rocketry program in the immediate postwar years to finally integrate and produce the first dedicated ballistic missile program in the Soviet Union. By 1945, however, each of the major players in that program had served their apprenticeship. For Korolev, and the rest of the aeronautical engineers in particular, despite severe obstacles and setbacks such as the Purges and the war itself, a solid training ground in the 1930s and 1940s had produced a number of bright and sharp individuals—all equipped to handle postwar challenges. If the rocket societies of the 1930s can be called the schools of apprenticeship for Korolev, Glushko, Tikhonravov and others, then the years 1945 and 1946 were to be their baptism from isolated technicians into pragmatic scientists, who would eventually have the industrial might of the nation behind them.

¹⁰² N N Bogolyubov et al eds V N Chelomey *izbrannyye trudy* (Moscow Mashinostroyeniye 1989) pp 6-7 10

¹⁰³ Rostislav Angelskiy 'Like the German V There Was the Russian Tenth X' (English title) *Aviatsiya kosmonavtika* 19 (August 1996) 27-40 Note that another source suggests that the date of his appointment was September 17 1994 See Colovanov *Korolev* p 727 The official order to produce an Fi 103-type analog was signed by Shakhurin on January 18 1945

¹⁰⁴ Angelskiy 'Like the German V' Steven Zaloga *Target America The Soviet Union and the Strategic Arms Race 1945-1964* (Novato CA Presidio 1993) p 113 Other sources suggest that the tests began in December 1944 See Bogolyubov et al eds V N Chelomey p 10

¹⁰⁵ Nina Chugunova 'V N Chelomey Highlights of His Biography' (English title) *Ogonek* no 4-5 (January 1993) 24-29 Valeriy Rodikov 'Im vremya dast taistvennyuy znatnost' in Shcherbakov ed *Zagadki zvezdnykh ostrovov* pp 5-7

¹⁰⁶ One of the major limitations of the IOX was the inaccuracy of its guidance system and it was this particular factor that seems to have precluded full production of the missile for the Soviet Air Force See Zaloga *Target America* p 113

CHALLENGE TO APOLLO



CHAPTER TWO FIRST STEPS

At the end of World War II in May 1945, the Soviet Union was in almost total ruins. No other nation in the world was as devastated and crippled by the war. Approximately 27 million Soviet people lay dead by the end of 1945.¹ In addition, with as many as 1,700 of the nation's cities destroyed, the industrial infrastructure was stretched to the limit. Half the housing in the country that had existed at the beginning of the war was no longer standing, and the productivity of the agricultural sector was close to famine proportions. To add hardship to the lives of ordinary Soviet citizens, the internal repression that had reached its peak in the late 1930s did not disappear after the end of the war. The millions who expected the end of hostilities with Germany to presage an era of societal order were to be very disappointed. In the immediate postwar years, the combined cruelty of Stalin and Beriya reached inhuman proportions. A wave after wave of Soviet citizens continued to disappear into the depths of the GULag system.

Given these distressing conditions, one would expect that an interest in such an esoteric idea as rocketry would have receded from the minds of engineers. In most Soviet accounts of postwar rocketry, however, descriptions abound in a peculiar sense of patriotism and sense of purpose that are difficult to explain. Filtering out what is obvious propagandistic prose, there is a clear subtext of "the mission," not among the bureaucrats and Communist Party officials, but among the young engineers themselves, most, if not all, of whom had already passed through immense hardships at the hands of both Hitler and Stalin. Some of this feeling is clearly attributable to the nature of the relentless aggression of the Nazis against Soviet citizens and the obvious wish to preclude such attacks on the Soviet Union ever again. But this patriotism, if it can be termed such, was also steeped in contradiction for the military scientist in the postwar Soviet Union. While one was actively pursuing science in the name of defending one's native land from attack, one was also implicitly maintaining the status quo of societal oppression that kept the country's paranoid leaders safe in their offices in the Kremlin. And compounding all else was fear. As there is a subtext of patriotism in descriptions of postwar rocketry, there is also a sense of almost mortal fear of the activities of Stalin and Beriya. It was this combined fear of the country's leaders and love of the country itself that provided the context within which the young aeronautical engineers of the 1930s and 1940s began slowly to regroup and start anew in 1945.

¹ The post *glasnost* official count was set at 27 million dead, although there is reason to believe that the actual count was as high as 34 million. See Fyodor Setin, "How Many Did We Lose in the War," *New Times* no. 7 (1990) 46-47. Steven Zaloga, *Target America: The Soviet Union and the Strategic Arms Race, 1945-1964* (Novato, CA: Presidio, 1993), pp. 30, 280.

In Germany

As the war in Europe ended in the late spring of 1945, all of the major allied powers began quickly to investigate and exploit the advances in German military technology. Even before the conclusive end of hostilities, the major rocketry centers of Peenemunde and Nordhausen had become prime targets for intelligence services. In the case of the Soviet Union, Stalin may have played a role in diverting troops first toward Peenemunde rather than Berlin in the last few months of the war. Precisely five days after Adolf Hitler's suicide in Berlin, on May 5, 1945, an infantry unit led by a Major Anatoliy Vavilov from the Second Belorussian Front took control of Peenemunde. The place was evidently deserted, and Vavilov faced little or no resistance.¹ Later, when Soviet forces occupied the A-4 plant at Nordhausen, the soldiers found the remains of thousands of concentration camp prisoners who had been forced to manufacture A-4s during the last days of the war.²

For Soviet officials who had been expecting a treasure trove of important information on the German rocketry program, the situation was indeed disappointing. As the Soviets would later learn, almost all the major German engineers working on the A-4 program had willingly surrendered to American military forces. In particular, Wernher von Braun, perhaps the most talented and powerful engineer among the Germans, had begun making plans for such a move well before the end of the war. As early as January 1945, von Braun and others had commenced preparations to relocate to a region that had a high probability of being occupied by U.S. forces.³ By early May, they were securely in the hands of the U.S. Army. They did not come empty handed. Apart from the 525 odd individuals who constituted the elite of the rocketry team, they also carried documentation on rockets spanning thirteen years. Earlier in April, U.S. forces had also stumbled into the giant A-4 plant at Nordhausen. Alongside the stacked bodies of hundreds of murdered camp slaves were scores of missiles in various stages of assembly. Within days, parts for at least 100 A-4 missiles were packed and shipped back into the U.S. zone before the arrival of Soviet forces.⁴ A major portion of what could not be taken back in the given time was simply destroyed. Soviet leaders who had expectantly awaited capture of this most precious war booty were in some cases stunned by the efficiency and swiftness with which these weapons were taken from under their noses. Stalin was reportedly quoted as saying:

This is absolutely intolerable. We defeated the Nazi armies: we occupied Berlin and Peenemunde; but the Americans got the rocket engineers. What could be more revolting and more inexcusable? How and why was this allowed to happen?

The Soviet effort to capture both German missile technology and expertise in the last days of the war seems to have been rather disorganized. There was clearly interest from a variety of

² Walter A. McDougall, *The Heavens and the Earth: A Political History of the Space Age* (New York: Basic Books, Inc., 1985), pp. 42-43; Frederick I. Ordway III and Mitchell R. Sharpe, *The Rocket Team* (New York: Thomas Y. Crowell, 1979), p. 261. The actual events leading to the capture of Peenemunde by the Soviet Army still remain somewhat unclear. Authoritative sources state that the site first came under Soviet control as early as March 9 or 10, 1945. See Ordway and Sharpe's text on page 111 (for March 9) and Boris Chertok, *Rakety i lyudi* (Moscow: Mashinostroyeniye, 1994), p. 98 (for March 10). However, it is clear that when Vavilov's unit first entered Peenemunde on May 5, there were still SS troopers at the site who had been awaiting the arrival of Soviet soldiers.

³ The Mittelwerk plant for the A-4 missiles was actually closer to the town of Niedersachswerfen rather than Nordhausen, although Soviet teams used the latter name more commonly than the former.

⁴ Ordway and Sharpe, *The Rocket Team*, pp. 254-55.

⁵ McDougall, *The Heavens and the Earth*, pp. 44-45.

⁶ Dr. G. A. Tokaty, "Soviet Space Technology," *Spaceflight* 5 (March 1963): 58-64. This quote is also excerpted in McDougall, *The Heavens and the Earth*, p. 44, but referenced to a different source.

sectors in the A-4 and the Fi-103, but at least in the first few months of Soviet operations in occupied German territory, these activities were not well coordinated or clearly defined. The Soviet Air Force had much incentive to gather information on these missiles, and the Commissariat of the Aviation Industry tapped its subordinate NII-1 as a source for engineering knowledge to support initial Air Force missions into newly captured territory. This was an obvious choice because many of the NII-1 engineers who had worked in the defunct Raketa group in 1944 had a rudimentary knowledge of some of the A-4's systems. Soviet artillery, primarily represented by the Mortar Guards Unit and the Chief Artillery Directorate, also had more than a cursory interest in German rocketry, and it seems that there was some degree of overlapping duties if not outright conflict between the needs of the Air Force and the needs of the Red Army Artillery in this matter.

Artillery officers viewed these advanced liquid-propellant missiles as merely extensions of the small *Katyusha* rockets that had been used so successfully during the war, and thus they were reluctant to share jurisdiction over missiles. In addition, the recommendations of the commission under Semenov and Tyulin in late 1944 clearly played a major role in the artillery branch's interest in these weapons. While the artillery and aviation sectors originally had autonomous and perhaps conflicting goals and duties, at the lower levels, there seems to have been a significant amount of interdependence. Most of the artillery officers had little or no expertise in missile technology and relied heavily on the interpretations of the young aviation engineers from NII-1. Furthermore, the latter group realized early on that their own bosses would not be very supportive of expending time and money to study German missiles. The engineers from NII-1 thus developed important relationships with powerful artillery officers who not only were far more favorable to the exploitation of German rocket technology, but who also saw missile weapons in general as potent tools of war.

One of the first teams to enter Germany to investigate German missiles was established in early May under the leadership of Maj. General Andrey I. Sokolov, who at the time was the deputy chief of the Mortar Guards Unit. He tapped Lt. Colonel Georgiy A. Tyulin to be part of the initial teams into Germany, presumably because Tyulin was familiar with both the Fi-103 and A-4 missiles. On May 24, the first group flew from Moscow to Berlin to begin the organization of an inspection team. Artillery officers on board included Lt. Colonel Anatoliy I. Semenov and Colonel Aleksandr G. Mrykin, both from the Chief Artillery Directorate, who were there to make assessments on production and procurement.⁷ The group was rounded out by several aeronautical engineers who had been asked to assist the artillery officers on technical issues during their field operations in Germany. The latter group included a number of NII-1 employees, including Aleksey M. Isayev, the leading rocket engine specialist at NII-1, and Arvid V. Pallo, a pre-Purge associate of Korolev's from NII-3.⁸

Flying first into Berlin, Sokolov and Tyulin's team slowly made their way to Peenemünde by the end of May. The scene that awaited them at the famous rocketry center was not encouraging. Not only was the place almost completely deserted by Germans, but there was almost nothing left behind to claim for the Soviet side. What still remained had been destroyed by the fleeing Germans or the Americans prior to the Soviet Army's capture of the launch site.⁹ For

7. Lt. Gen. (Ret.) G. Tyulin, "The 'Seven' Years. Accomplishments, People" (English title), *Krasnaya zvezda*, April 1, 1989, pp. 3-4; Yu. A. Mozzhorin, et al., eds., *Dorogi v kosmos I* (Moscow: MAI, 1992), p. 156; Carl-Fredrik Geust, *Under the Red Star* (Shrewsbury, UK: AirLife, 1993), p. 115. In this last source, the author suggests that the May 24 team was led by Lt. General Gaydukov, the Communist Party's point man on artillery affairs, but it seems that Gaydukov arrived in Germany much later.

8. Chertok, *Rakety i lyudi*, p. 67; Yu. A. Mozzhorin, et al., eds., *Dorogi v kosmos II* (Moscow: MAI, 1992), pp. 42-43. Others along with Isayev and Pallo included Rayetskiy, Raykov, and Berglyezov.

9. G. A. Tokaty, "Foundations of Soviet Cosmonautics," *Spaceflight* 10 (October 1968): 335-46.

several days, Sokolov's team literally scoured through piles of garbage attempting to make some sense of what might have existed at Peenemünde. According to Tyulin:

The test beds, the laboratory buildings, the shops of the experimental plant and the launching equipment of the [A-4] were depressing to look at. The bombing of Hitler's missile citadel . . . had attained its goal. The full-scale production plants in the vicinity of Nordhausen created the same impression.¹⁰

Equally disappointing for the Soviets was the fact that of all the Germans captured at the site, none were key officials in the development of either the Fi-103, the A-4, or any of the other many tactical missiles created during the war. As the inspection team members interrogated the remaining Germans through May and June, it was increasingly clear that not one was an expert in any field, although many did have extensive technical experience in manufacturing shops and plants.

On June 1, another group of Soviet engineers and officers, the latter from the Air Force, arrived at Peenemünde. Among this team was Boris Ye. Chertok, a thirty-three-year-old guidance systems engineer who had worked in the Raketa group at NII-1 in 1944.¹¹ At Peenemünde,



A rare photo showing artillery Colonel *Georgiy Tyulin (left)* and *Sergey Korolev* in Germany in 1946 during the A-4 missile recovery operations. Tyulin would rise swiftly in later years, becoming one of the most important managers of the Soviet space program in the 1960s (files of Peter Gorin)

¹⁰ Tyulin "The Seven"

¹¹ Chertok *Rakety i lyudi* p. 66. Chertok had actually arrived earlier in Germany. He had been on one of the first inspection teams to arrive in late April as part of an Air Force group interested in German radar and precision instrument research.

CHALLENGE TO APOLLO

Chertok took a leading role in making impartial assessments of leftover German remains. The preliminary impressions resulting from the combined inspection of the artillery and Air Force groups at Peenemunde in May and June had repercussions not only on the perceived level of German missile technology, but they also reflected poorly on the accomplishments of the Soviets themselves. By the end of the war, the most powerful operational Soviet rocket engine had a thrust of one and a half tons, The A-4, meanwhile, had used an engine with a thrust of twenty-seven tons—a staggering gap, especially when one considers the roughly comparable activities of the rocketry groups in the 1930s in both Germany and the Soviet Union. The Soviets did not have a single program for the development of a long-range ballistic missile. Tyulin had no doubt as to the reasons for the lag:

*In Germany we realized that if there were no arrests, we would have reached a very high technical level as early as the late thirties. As a result of repressions in the army and the scientific community, the development of our rocketry had stopped at powder rockets, and only when our leaders learned about the "V" rockets, Stalin took an interest in rocketry."*¹²

Despite the apparent weaknesses in Soviet expertise, officials were quick to emphasize that there was also reason to feel somewhat positive. Following the initial survey of German technology, a member of the Air Force evaluation team recalled that:

... so far as theories and projects were concerned, the Soviet rocket scientists and engineers appeared to be, basically, as advanced, as inventive and as clever as their German counterparts; but in putting these theories into practical technology we turned out to be miles behind the Germans!"

Among the more curious finds at Peenemünde was a German edition of a book by Tsiolkovskiy on rocketry and spaceflight. To the surprise of the Soviets, almost every page of the monograph was embellished by von Braun's comments and notes. Elsewhere in the archives of the Nazi Air Ministry, the Soviets were even more surprised to find detailed drawings of a missile designed by Tikhonravov during the late 1930s at NII-3, during a time when all such work was classified." There was no apparent explanation of how the information made its way into German hands.

Chertok and the others arrived at the Mittelwerk plant in Nordhausen on July 14 and immediately began to create some sense of order out of the chaotic state at the factory. The visiting Soviets were without doubt much more impressed by the facilities at Mittelwerk than those at Peenemunde. The plant was built into the side of a mountain, with two three-and-a-half-kilometer-length galleries, allowing entire trains to enter the facility. Here, the Soviet team discovered several A-4s in various stages of assembly, and team members carefully documented all available findings for later analysis and study. German technicians who had remained behind at Mittelwerk shocked the Soviet occupiers by stating that production levels at the facility had remained at peak levels until almost the end of May. Approximately thirty-five complete missiles were apparently being turned out every day that month." Having collated the preliminary

¹² Mariya Pastukhova "Brighter Than Any Legend" (English title) Ogonek 49 (December 1987) 18-23

¹³ Tokaty "Foundations of Soviet Cosmonautics "

¹⁴ Roald Z. Sagdeev *The Making of a Soviet Scientist: My Adventures in Nuclear Fusion and Space From Stalin to Star Wars* (New York: John Wiley & Sons, 1993) p. 5 fn. 2; Michael Stoiko *Soviet Rocketry: Past, Present and Future* (New York: Holt, Rinehart and Winston, 1970) p. 64

¹⁵ Chertok, *Rakety i lyudi*, p. 108

information on the plant, the inspection group moved to Bleicherode on July 18 and set up shop at the Villa Franka, which had served as von Braun's home during the latter days of the A-4 effort. By this point, the Soviet group had managed to gather together about 200 German technicians who had worked on missiles during the war. There still seems to have been efforts, both overt and covert, to capture some of the more important individuals in the A-4 program, in particular von Braun. A German engineer related to U.S. authorities on August 15:

I had been for several days in [the] Russian occupied zone around Bleicherode to pick up my baggage, which had been left there. At this occasion I spoke to an old collaborator. . . . He told me that the Russians intended to develop a big rocket for a normal range of 3,000 miles and that they are needing specialists with knowledge of the theory of flight mechanics and control equipment. He told me that the Russians set big prices for getting over to Russian area Prof. V Braun and Dr Steinhoff.⁶

None of these efforts met with success, although several members of the inspection commission continued to travel to the U.S. occupation zone to make offers to middle-level engineers.

At Bleicherode, the engineers on the Soviet inspection team settled down with their information and were given permission to establish a joint Soviet-German centralized coordination center not only for the further collection of information, but also to attempt to reestablish production of the A-4 at the Mittelwerk plant as soon as possible. The Soviet military administration in Germany named it the Institute Rabe, for "raketenbau und entwicklung," which was German for rocket manufacture and development." Major Chertok was named the co-leader of the institute along with a German engineer named Gunther Rozenplenter. NII-1 veteran Isayev was appointed to handle all propulsion issues.

Upon the formation of the Institute Rabe, a veritable flow of Soviet aeronautical engineers from NII-1 and elsewhere began to converge first in Berlin and then at Bleicherode. On July 25, Yuriy A. Pobedonostsev, Korolev's old GIRD associate, arrived in Germany, quickly becoming one of the leading engineers in the A-4 restoration operation.¹⁸ A major influx of technically competent Soviet engineers occurred in early August. This group was sent to Germany under extremely strict secrecy, far more than had been subjected to the earlier team in May. All the individuals in the new group had been summoned the day prior to their departure to a Party Central Committee department and were only told that they were to leave for Germany the next day as members of a secret Special Technical Commission. None were told the goal of the mission, and all were given military ranks on the spot to preclude questions from the other Allies on the role of civilians in the occupied zones. Flying aboard the Li-2 aircraft on August 9, 1945, were Yevgeniy Ya. Boguslavskiy, Vasily P. Mishin, Nikolay A. Pilyugin, Viktor A. Rudnitskiy, Mikhail S. Ryazanskiy, and less well-known engineers Bakurin, Floreyskiy, and Goryunov." Both Mishin and Pilyugin were well acquainted with the A-4's basic elements, having worked on the examination of parts recovered at NII-1 in 1944. Upon his arrival at Rabe, Pilyugin, an expert on guidance systems, was appointed the first deputy chief of the institute. Further arrivals later in August represented a variety of fields in rocketry, such as liquid-propulsion rocket engines, guidance systems, control systems, gyroscopes, launch facilities, and flight testing. The tech-

16 Ordway and Sharpe *The Rocket Team* p 290

17 *Ibid* p 320 Chertok *Rakety i lyudi* p 116 Rabe itself was also the German word for "raven"

18 Valeriy Zharkov "Pobedonostsevs Criteria" (English title) in V Shcherbakov ed *Zagadki zvezdnykh ostrovov knrga pyataya* (Moscow Molodaya Gvardiya 1989) p 94

19 B Kononov "From Germany—To Kapustin Yar" (English title) *Izvestiya* April 6 1991 p 3 One source says that Ryazanskiy had actually arrived in Germany before in either late April or early May 1945 See Mozzhorin *et al* eds *Dorogi v kosmos* 1 p 160

nical expertise of the Institute Rabe swelled as individuals such as Vladimir P. Barmin, Aleksandr Ya. Bereznyak, Vasilii S. Budnik, Semyon G. Chizhikov, Vasilii I. Kharchev, Nikolay M. Kurilo, Viktor I. Kuznetsov, Yevgeniy M. Tsetsior, and Leonid A. Voskresenskiy converged at the former German rocketry centers in August 1945.²⁰

While these engineers were essentially part of the technical aspect of the operations, the artillery sector began to take control over many of the higher decision-making levels. Based on information received in Moscow through the summer, in August, the commander of the Mortar Guards Unit, Maj. General Nikolay N. Kuznetsov, established a central command for rocketry operations in Berlin to serve as the nerve center of the Special Technical Commission (OTK in its Russian abbreviation).¹ As the first head of OTK, Kuznetsov explained to all those involved that the Institute Rabe and all subsidiary work on restoring A-4 operations would now be under the command of the artillery sector, specifically the Chief Artillery Directorate. It was understood by the members of OTK that the question of which "ministry" would take over missile production was still being debated, a result of vacillation on the part of the aviation sector on its role in ballistic missile development.

Kuznetsov's boss back in Moscow, Maj. General Lev M. Gaydukov, apparently was a vigorous advocate for moving the whole sector to the armaments industry, which had produced the solid-propellant Katyushas during the war. Gaydukov himself visited Nordhausen in August to make a personal assessment of the work of the 284-strong team in Germany. Gaydukov and Kuznetsov appointed the young Lt. Colonel Tyulin as a deputy chief of OTK to be stationed at Berlin to direct and coordinate field operations of all the aviation engineers. Former NII-1/Raketa and GIRD member Pobedonostsev served as the top engineering coordinator of OTK. By this time, the field of operations in Germany comprised: the Zentralwerke, an assembly plant located at an old A-4 repair depot at Klein Bodungen; the Institute Rabe under Chertok and Pilyugin, whose duties were focused on reconstructing the A-4 guidance systems; and the propulsion test stands at Lehesten, where Pallo and Isayev were in the process of cataloguing information on rocket engines."

Perhaps one of the more successful phases of the early work in Germany was carried out at Lehesten. Located close to Nordhausen in southern Thuringia, OTK engineers Isayev and Pallo had essentially taken over control of the facility in the early summer of 1945 in the interest of restoring "normal" levels of testing, which was understood to be more than thirty firings per day. In July, Pallo became the chief of static testing at about the same time that the Soviets uncovered one of the more significant treasures, a set of more than fifty brand new tested and certified combustion chambers in an underground depot at Lehesten.¹ In addition, the Soviets discovered fifteen completely undamaged railway cars containing a plethora of equipment, some of which were also cars used for transporting the A-4 missiles and propellant to various sites.

In their operations in Germany, the Soviets were assisted by German engineers and technicians at every site. While the Soviets early on conceded that the best and brightest from the Peenemünde team were in the hands of the Americans, they did not shirk from using the services of those who remained as much as possible. In addition, every effort was made to "capture" more technically adept Germans. In the early fall of 1945, the Soviets started a dedicated program, designated Operation Ost, to explore the possibility of adding more capable Germans to the services of OTK. Led by Institute Rabe head Chertok, these efforts were partially

20 Chertok *Rakety i lyudi* pp 121-22, 124. The assigned military ranks of some of these engineers were Barmin (Colonel), Chertok (Major), Isayev (Lt. Colonel), Kuznetsov (Colonel), Mishin (Lt. Colonel), Pallo (Major), Pilyugin (Colonel), Pobedonostsev (Colonel), Ryazanskiy (Colonel), and Voskresenskiy (Lt. Colonel).

21 *Ibid* pp 123-24. Mozhgorin et al eds *Dorogi v kosmos II* pp 75-76.

22 Mozhgorin et al eds *Dorogi v kosmos I* p 137.

23 Chertok *Rakety i lyudi* pp 155-56.

successful. He coordinated several trips by the Burgomeister of Bleicherode, who crossed the Werra River into U.S.-captured territory to make offers to Germans at Witzenhausen. One of those who responded favorably was Helmut Grottrup, the former assistant to the director of the Guidance, Control, and Telemetry Laboratory at Peenemünde, who made at least two secret trips into Soviet-controlled territory to discuss his future. In mid-September of 1945, Grottrup and his family finally moved permanently to the Institute Rabe at Bleicherode, adding a very significant asset to the capabilities of OTK.²⁴ Grottrup's reasons for siding with the Soviets had evidently less to do with political affiliations than his reluctance to leave Germany. Others who eventually put their lot with the Soviets included aerodynamicist Dr. Werner Albring, design engineer Josef Blass, guidance and control expert Dr. Johannes Hoch, gyroscope and theoretical mechanics specialist Dr. Kurt Magnus, propellants chemist Dr. Franz Mathes, propulsion specialist Dr. Joachim Umpfenbach, and ballistics expert Dr. Waldemar Wolff.²⁵ While none of them had played any major roles in the development of the A-4 or any of the other missiles developed by the Peenemünde team, their services were indispensable to the Soviets in mastering construction, production, and testing operations.

OTK was augmented by two further and certainly more important additions in September 1945. Maj. General Gaydukov, the Communist Party's representative for OTK and the head of all A-4 recovery operations in Germany, was apparently very conscious of the need for qualified engineers to be in Germany to participate in the work of the commission. He also happened to be aware of the rich history of rocketry in the Soviet Union, including the activities at GIRD and NII-3 in the 1930s. In the late summer of 1945, Gaydukov prepared a list of aeronautical engineers who he believed would be great assets to the OTK effort in Germany but who had all been incarcerated in the late 1930s as a result of the Great Purges.²⁶ It was a calculated move on Gaydukov's part, but it worked. Two of the names on the list given to Stalin himself were Sergey P. Korolev and Valentin P. Glushko.

Korolev had been working at OKB-SD since July 1944 in Khimki on a variety of rocket engines to assist fighter planes in taking off. An effort to interest the aviation industry in long-range missiles did not produce fruit." In late August, both Glushko and Korolev were finally discharged from work at OKB-SD, the latter immediately returning to Moscow to see his wife Kseniya and daughter Natalya, whom he had not seen since 1940. It was his first real taste of freedom in more than seven years. The holiday with his family proved to be unusually short. In early September, Korolev was summoned to the Commissariat of Armaments in Moscow and informed of the work of scientists and engineers in Germany working on restoring A-4 production: he was immediately assigned to join that effort.²⁸ Summarily given the military rank of Lt. Colonel, Korolev flew via Warsaw into Berlin on September 8 and was received by

24 Ibid p 126 Peter Smolders 'I Meet the Man Who Brought the V 2 to Russia' *Spaceflight* 37 (July 1995) 218-20 Ordway and Sharpe *The Rocket Team* p 319

25 Christian Lardier *L'Astronautique Soviétique* (Paris Armand Colin 1992) pp 72-73 Ordway and Sharpe *The Rocket Team* p 335 Chertok *Rakety i lyudi* pp 125-26

26 Chertok *Rakety i lyudi* pp 137-38

27 On June 30 1945 Korolev submitted a second draft of his D 1/D 2 missile proposal to the leaders of the Commissariat of the Aviation Industry As in his prior report Korolev advocated the establishment of a special design bureau attached to NII 1 to focus on bringing the D 2 project to fruition In addition to a list of engineers that he believed should be transferred to this new bureau he also set out a timetable for work on the missile to begin on November 1 1945 Perhaps most significantly Korolev emphasized the need to study not only captured German missile technology but also U.S. and British efforts in the field See Yuri Biryukov and Vikentiy Komarov 'S P Korolev in the Sharashka' (English title) in Shcherbakov ed *Zagadki zvezdnykh ostrovov* pp 108-09 G S Vetrov 'S P Korolev i kosmonavtika peruye shagi' (Moscow Nauka 1994) p 184

28 Aleksandr Romanov Korolev (Moscow Molodaya Gvardiya 1996) pp 200-05 First Deputy Peoples Commissar of Armaments V M Ryabikov informed Korolev of his new assignment

Lt. Colonel Tyulin. By this time, the latter, in addition to his duties as a deputy head of OTK, was also the head of the new Institute Berlin, established to gather and analyze all available documentation on German missiles in one place.²⁹ Glushko, given the rank of colonel, arrived in Berlin at this time, although he did not fly in with Korolev.

The addition of both Korolev and Glushko to OTK added very significantly to the expertise of the investigation team in Germany. They were undoubtedly two of the brightest and most experienced engineers in the field of rocketry in the Soviet Union, and the majority of the other members of the team were well acquainted with their work in the 1930s. In late September, after a few weeks familiarizing himself with the nerve center of operations at the Institute Berlin, Korolev was taken to the Institute Rabe in Bleicherode. Characteristically, he did not waste much time, and within days, he began to take a leading part in the operations of OTK. One of his first actions was to establish a special subgroup of the commission, designated *Vystrel* ("Shot"), specifically for studying and learning the preparations for launching the A-4. He appointed two of the former NII-1 veterans, Voskresenskiy and Rudnitskiy, as leading members of the team to gather and sift through all available documentation. Glushko meanwhile was sent to Lehesten to oversee work on A-4 engines. Isayev and Pallo, both of whom had been instrumental in laying a solid base for future work at the site, were ordered to return back to Moscow, and all the work at the plant was taken over by Glushko and his deputy Vitaliy L. Shabranskiy.³⁰

The actual search for documentation turned out to be somewhat harder than anticipated. For example, in the fall of 1945, rumor reached the Institute Berlin that a railway truck loaded with missile drawings that were to have been sent to Austria by the fleeing Germans had been captured by Czechoslovak insurgents near Prague. Mishin, being one of the most well acquainted with the design of the A-4 rocket, immediately left for Prague to investigate the matter. In the Czech capital, he was able to locate an A-4 production coordination office, which had directed the supply of parts from scores of companies in Austria, Hungary, Poland, and Czechoslovakia during the war. Despite this obviously significant prize, he was still unable to locate the mysterious train. After pleas to the British administration officials nearby fell on deaf ears, he was able to use some "unorthodox measures" to finally locate and secure all the missile documentation. It seems that OTK engineer Bereznyak's sister Mariya, who had been imprisoned in a concentration camp by the Germans, played a major but still unknown role in the find.³¹

Korolev and Glushko both assumed relatively important roles in the work of OTK by late 1945, and there clearly seems to have been an implicit recognition in the abilities of both individuals by the leadership. Both were highly talented and professional engineers with formidable theoretical and practical backgrounds in missile and aviation technology. In addition, Korolev had a tremendous ability for administrative and managerial tasks. At least in the initial stages of cooperation, he was very cooperative with all the German engineers, no doubt helped by his fluency in the German language. Glushko, on the other hand, while probably a better engineer, was less successful in dealing with either the Germans or his subordinates. He was a perfectionist and insisted on being involved in every last detail of the work of his assistants. In

29. Mozzhorin, et al., eds., *Dorogi v kosmos: II*, p. 76; Chertok, *Rakety i lyudi*, p. 141. The original head of the Institute Berlin was D. G. Dyatlov.

30. Kononov, "From Germany—To Kapustin Yar"; Chertok, *Rakety i lyudi*, pp. 144, 147, 157. The *Vystrel* group was originally headed by Korolev, but after his appointment as chief engineer of the Institute Nordhausen, Voskresenskiy replaced him.

31. Kononov, "From Germany—To Kapustin Yar"; Geust, *Under the Red Star*, pp. 116-17; Boris Kononov, "Soviets Rocket Triumphs Started in Germany" (English title), *Izvestiya*, March 5, 1992, p. 5.

addition, it seems that he had little appreciation or tolerance for any of the German work from the Peenemunde team." It was perhaps the cumulative effect of their different approaches to the work in Germany that eventually resulted in the effective reversal of their roles during the war. It was increasingly clear by the end of 1945 that of all the engineers working for OTK, Korolev was the one to watch.

During their time in Germany, on only one occasion did either Korolev or Glushko come into contact with U.S. or British forces. In early October 1945, the three Western powers conducted a series of preliminary firings of the A-4 from Cuxhaven on the North Sea shore. For the third launching on October 15, Soviet representatives were invited to witness the launch. Five officials were sent on behalf of the Soviet side. Lt. General Sokolov, who led the initial teams into Peenemunde. Lt. Colonel Tyulin, Pobedonostsev, Glushko, and Korolev. Despite much "arm waving and shouting," Korolev was not allowed into the launch-viewing area by U.S. Maj. General Alexander M. Cameron, chief of the Air Defense Division, Supreme Headquarters, Allied Expeditionary Force. Korolev was escorted outside the compound and had to view the launch from a much farther distance. Later that day, he was also prohibited from viewing the assembly and checkout area despite angry complaints. Pobedonostsev, for his part, spoke briefly with one of the German observers, a Lieutenant Hochmuth, casually telling him that he was aware that the A-4 material from Mittelwerk was going to White Sands in New Mexico—a piece of information that was supposed to be top secret at the time. Pobedonostsev also complained of having "a hell of a time" at Nordhausen because the U.S. side had "cleaned the place out." He offered the Allies a tour of Nordhausen if the U.S. side would reciprocate with a similar offer to show White Sands to the Soviets. The U.S. Army refused the offer, although it seems that the Allies would definitely have been in a position to gain much more, because White Sands at the time was essentially barren." The Soviet team returned from Cuxhaven to their side of Germany with little concrete information. The time ahead was to be critical for laying the groundwork for their own launchings.

Research on the A-4 was only a part of the overall work of the engineers in Germany. A significant portion of the occupation was focused toward capturing a myriad of other types of military technology, such as fighters, bombers, and tanks. In the case of missiles, OTK had groups working on acquiring knowledge on such surface-to-air German missiles as the Schmetterling, Typhoon, and Wasserfall. Perhaps the most interesting of these areas of investigation was a theoretical study from August 1944 authored by Viennese engineers Dr. Eugen Sanger and Dr. Irene Bredt of the Airmail firm Deutsche Luftfahrtforschung, titled "Über Einen Raketenantrieb Fernbomber" ("On a Rocket Propulsion Engine for Long-Range Bombers"). The Nazis had evidently published only 100 copies of the study. Sanger and Bredt foresaw the use of a 100-ton single-stage piloted rocket-aircraft for dropping 300-kilogram bombs over transcontinental ranges. The vehicle, also called the "antipodal bomber," was designed to be launched from a sled, reaching a maximum velocity of six kilometers per second and a maximum altitude of more than 160 kilometers. Sanger and Bredt theorized that following launch, the spaceship would dip into the atmosphere at a shallow angle and skip once again back into space—a process that would be repeated several times until, during one of the dips, the ship would drop a bomb over the desired target." The Luftwaffe had initially supported the project.

32 Zaloga. *Target America*. p. 119

33 Ordway and Sharpe. *The Rocket Team*. pp. 306-07; Tyulin, "The 'Seven'."

34 Irene Sanger-Bredt, "The Silver Bird. A Memoir," *History of Rocketry and Astronautics. Vol. 7 part 1* (San Diego, CA: American Astronautical Society, 1986); Kenneth Gatland, ed., *The Illustrated Encyclopedia of Space Technology: A Comprehensive History of Space Exploration* (New York: Harmony Books, 1984), pp. 199, 204; Henry Matthews, *The Secret Story of the Soviet Space Shuttle* (Beirut, Lebanon: Henry Matthews, 1994), p. 22; Ordway and Sharpe, *The Rocket Team*, p. 327.

CHALLENGE TO APOLLO

encouraged by the assertion that the bomber would be capable of reaching New York City. Little work on the bomber was carried out by the Germans, however, as the war ground to a halt. During the exploratory work of Soviet engineers in Germany, Isayev had initially discovered the document at Peenemünde in May 1945. The capabilities of the antipodal bomber had apparently startled the Soviets, and news had even reached Stalin's ears. It seems that his interest was serious enough for him to appoint a special group from the Air Force to investigate the issue."

The months of indecision on the part of the aviation sector on the issue of developing long-range ballistic missiles finally came to a resolution. In November 1945, a representative from the Central Committee of the Communist Party arrived in Berlin to inform the leaders of OTK that while the Party leadership was satisfied with the work of the commission, efforts in Germany would cease in early 1946, until a final decision on which industrial sector to allocate the work had been made.³⁶ The representative also announced that Maj. General Gaydukov would take over the position as chairman of OTK, replacing the indisposed Maj. General Kuznetsov, who was recovering from an automobile accident in late September. Gaydukov's appointment was propitious for he was not only one of the most vigorous supporters of the valuable work in Germany, but he had also personally given Stalin the list including Korolev's name that had added the latter's valuable talents to the work of OTK.

Gaydukov inherited the honor of making perhaps one of the most important policy decisions in the early history of the Soviet rocketry and space programs. Stalin had given him the responsibility of selecting a "ministry" to oversee the missile effort in Germany. There were three choices: the Commissariat of the Aviation Industry, the Commissariat of Ammunitions, or the Commissariat of Armaments." Gaydukov first offered the role to People's Commissar of the Aviation Industry Aleksey I. Shakhurin, but the latter was not impressed. Similar to his earlier decisions in 1944, Shakhurin saw no future in missiles and continued to believe in the possibilities of rocket-powered aircraft. Shakhurin's rejection had grave implications for OTK because most of the engineers of the commission were still officially under the employ of the aviation sector.³⁸ People's Commissar of Ammunitions Boris L. Vannikov was interested, but Stalin unexpectedly tapped him to oversee administrative aspects of the atom bomb project. For Gaydukov, this left one remaining choice, the Commissariat of Armaments, headed by a thirty-seven-year-old former mechanical engineer who would go on to play one of the most crucial roles in the history of the Soviet space program. Dmitriy Fedorovich Ustinov."

Ustinov was born on October 30, 1908, in Samara, and he graduated from the Leningrad Military Mechanical Institute as a mechanical engineer in 1934. By 1938, he was the director of the Bolzhevik Arms Factory, one of the most important armaments facilities in the Soviet Union. Certainly, his quick rise to this prominent position was partly because of the massive toll of the Purges in the late 1930s, which resulted in much of the original and more experienced industrial hierarchy being decimated. The lack of qualified individuals at the beginning of the war prompted Stalin to pick the thirty-two-year-old Ustinov as the People's Commissar

35 Zaloga *Target America* p 122 Chertok *Rakety i lyudi* p 91 The chief of the Air Force department of the Soviet Military Administration in Germany Lt General T. F. Kutsevalov was the most enthusiastic and vigorous advocate of the project See D. A. Sobolev *Nemetskyy sled v istorii sovetskoy aviatsii* (Moscow: RiTs Avianbik 1996) pp 83-85

36 Chertok *Rakety i lyudi* p 137

37 *Ibid* p 138

38 *Ibid* p 160 In late 1945 all NII I employees who were part of the commission in Germany were immediately ordered to return to the Soviet Union to resume work on aircraft. A second attempt to reduce the rocketry recovery effort in Germany occurred in early 1946. Both of these potentially disastrous orders seem to have been stalled by Gaydukov as he looked for a more acceptable alternative.

39 *Ibid* p 140

of the Armaments in 1941. The inexperienced industrialist was responsible for the design and production of a host of Soviet ground and tactical weaponry. Ustinov did not disappoint Stalin, and it was clear by the end of the war that he had done an outstanding job marshaling the resources of the state to produce huge amounts of ammunitions. Younger than both Korolev and Glushko. Ustinov was well respected in the government and seems to have managed to somehow remain outside of ongoing political intrigues that inevitably landed many a bureaucrat in the GULag. Prior to finalizing the arrangement of transferring all Soviet ballistic missile efforts to the Commissariat of Armaments, Stalin and Gaydukov had Ustinov send his deputy, Vasilii M. Ryabikov, to Germany to personally assess the level of work at Berlin, Nordhausen, Lehesten, and elsewhere. It was a short visit, but it was pivotal for the landmark decisions of 1946.



Minister of Armaments Dmitry Ustinov shown here in the 1940s was the principal industrial architect of the Soviet ballistic missile program. In various posts he remained the manager of the missile and space programs during a period spanning almost forty years (copyright Steven Zaloga)

NII-88

The work of OTK continued in early 1946 with two clear goals: the restoration of wartime production of A-4 missiles and the accomplishment of the first postwar launches of these missiles from German soil. As Korolev assumed more of a pivotal role in the work of the commission, plans were falling into place for testing a series of A-4 vehicles in 1946 in coordination with the scores of German engineers who had either been captured or voluntarily aligned themselves with the Soviets. These plans had evidently originated from suggestions from Korolev following his viewing of the Allied A-4 launches at Cuxhaven in October 1945. He himself received official recognition for his work in Germany in February, when he was briefly recalled to Moscow and promoted to the rank of colonel — the same as such other prominent engineers of OTK as Pobedonostsev, Glushko, and Pilyugin.⁴⁰ During the visit, he also met with Georgiy M. Malenkov. Stalin's right-hand man, and reported on the general state of OTK's investigations. Arriving back in Berlin in early March, Korolev was in an unusually cheerful mood, no doubt because he had been told back in Moscow that his name was one of those under consideration as possible engineering head of a central organization for the design of Soviet ballistic missiles.⁴¹ Soon after Korolev's return to Germany, Gaydukov officially announced that all of OTK's operations would now be further coordinated by the new Institute Nordhausen, which would replace the old Institute Rabe. He also revealed that he himself had been appointed the director of the institute and that Korolev would now be the first deputy director and chief engineer.⁴²

40. *Ibid.* p. 162: Tyulin, "The 'Seven'."

41. Mozzhorin, et al., eds., *Dorogr v kosmos 1*, p. 118.

42. *Ibid.* p. 137: Chertok, *Rakety i lyudi*, pp. 162–63. Note that the first source states that the reorganization was in May and not in March 1946.

The reorganization in March 1946 led to the formal establishment of the following divisions of OTK, all led by the Institute Nordhausen:

- Plant No. 1 (also known as the Design Bureau Olimpiya) at Sommerda, about fifty kilometers east of Leipzig, set up at the premises of the Rheinmetall-Borsig firm and headed initially by Budnik and then by Mishin, for the collating of all technical documentation on the A-4
- Plant No. 2 (also known as the Montania Plant) at Lehesten, designated for the assembly, production, and testing of all rocket engines and headed by Glushko and Shabranskiy
- Plant No. 3 (also known as Zentralwerke) at Klein Bodungen, for pilot production of A-4s and headed by Kurilo
- Plant No. 4 at Sonderhausen, for the preparation of A-4 guidance systems and other electrical equipment, staffed by those who were formerly at the Institute Rabe, including Boguslavskiy, Chertok, Pilyugin, and Ryazanskiy
- The *Schparkasse* group, headed initially by Mishin and then by Lt. Colonel Tyulin and staffed by several artillery officers, for theoretical problems, including ballistics
- A special Soviet-German bureau, headed by the German Grottrup, which was given the task of preparing a detailed history of the A-4 development program with a focus on guidance systems, radiotechnical elements, and the selection of propellants
- The *Vystrel* group, headed by Voskresenskiy and Rudnitskiy and including Institute Berlin Chief Engineer Barmin, for mastering launch and testing procedures"

The primary goal of the entire operation was to restore production of the A-4 missiles sufficiently to manufacture several dozen of the vehicles for flight testing. This goal gradually became the primary objective for OTK in Germany as Korolev delegated the responsibility for launch operations to Voskresenskiy. The German engineers under Grottrup were indispensable in this effort, filling in gaps in the information whenever there were problems. In addition, because of the geographically scattered nature of the original wartime German production facilities for the A-4s, many of the parts for the missiles were no longer available, because the manufacturing entities now resided in either British or U.S. territory. Resourceful Germans under Grottrup were, however, able to obtain many components from the Allies by bartering with food, tobacco, or alcohol." The sights of abandon and wreckage at Peenemünde and Nordhausen in the early summer of 1945 had prompted feelings of pessimism among Soviet officials and engineers. Yet, only a year later, the commission was close to assembling a limited number of full-scale A-4 missiles from Mittelwerk.

Cooperation between the Germans and the Soviets was for the most part harmonious and to a degree a function of the Soviet engineer who had responsibility for a particular area. For example, rocket engine firings at Lehesten were evidently conducted at first under the direction of Dr. Urnfenbach, but were taken over by Glushko once the exact processes had been mastered. While the intensity of the joint activities between the Soviets and the Germans may have varied, the work of OTK did for the first time bring together scores of Soviet engineers and military officers under a single umbrella organization. Almost all of the major chief designers of the Soviet space program up until the late 1980s were members of this commission in Germany, an astonishing historical precedent that has no parallel in the U.S. space program. Many of the Soviet individuals in fact made their first acquaintance with each other in Germany in the immediate postwar period.

43. Chertok. *Rakety i lyudi*, pp. 163-64; Mozzhorin, et al., eds., *Dorogi v kosmos: I*, pp. 137-38; Ordway and Sharpe. *The Rocket Team*, pp. 320-21.

44. Ordway and Sharpe. *The Rocket Team*, p. 321.

The pivotal nature of the work in Germany in 1945–46 eventually gave rise to the important question of the elaboration of a national agenda with respect to ballistic missiles. The question of defending the territory of the Soviet Union after a devastating war was clearly on the minds of Soviet leaders. At the end of World War II, the Soviet Union may have had the most powerful land force in the world, but this power had suddenly become secondary following the events of August 1945. With the destruction of Hiroshima and Nagasaki by atomic bombs, the United States had revealed its absolute military superiority over any other country in the world. For Stalin in particular, this was unacceptable. While work on the development of nuclear weapons had been conducted during the war, the bombings in Japan prompted Stalin to move this work to an urgent footing. Just eighteen days after Potsdam and fourteen days after Hiroshima, on August 20, 1945, a secret decree of the Central Committee and the Council of Ministers called for the formation of the Special Committee on the Atomic Bomb to direct and coordinate all efforts on the rapid development of operational nuclear weapons.⁴⁵ This committee was headed by secret police head Beriya himself, and its work was kept concealed even from some members of the Politburo. Acutely aware that having a nuclear weapon was only one-half of the solution, efforts were simultaneously focused on a delivery system for these explosives. Taking a cue from the magnificent American B-29 bomber, the Soviet leadership began to explore the possibility of creating analogous aircraft for the delivery of nuclear weapons. This effort was in fact taken to pathological extremes with the construction of carbon copies of a captured B-29 in the postwar years.⁴⁶ Unwilling to rule out even the most unlikely of propositions, it also seems that Stalin had been keenly interested in missiles as weapons of war. The impressive performance of the German A-4 undoubtedly attracted his attentions, and the possibility of using such vehicles with nuclear weapons was not an avenue of research he was about to ignore.

On March 18, 1946 at the first session of the Supreme Soviet of the USSR, the rubber-stamp parliament of the country, a decree was adopted recommending the development of new technologies as part of the Soviet Union's rebuilding. In particular, the decree clearly called for "efforts towards ensuring further increases in the defensive capabilities of the USSR and ensuring the equipping of the armed forces of the Soviet Union with the latest military technology."⁴⁷ This first decree set the stage for an official visit by a commission of high industrial and military leaders to Germany to investigate and assess the work of OTK. The chairman of the visiting commission was Marshal Nikolay D. Yakovlev, the commander of the Chief Artillery Directorate, the military organ that had legal control over most of the artillery officers within OTK. Other members were: the Commander-in-Chief of Artillery Forces of the Red Army, Nikolay N. Voronov; the current Chief of Staff of the Southern Forces Group of the Red Army, Col. General Mitrofan I. Nedelin; and People's Commissar of Armaments Ustinov, the defense industrialist appointed by Stalin to lead the new rocketry sector in the Soviet Union.⁴⁸ Nedelin, at the time forty-three years old, was one of the brightest and most accomplished officers in

45 Yu P Maksimov ed *Raketnyye voyska strategicheskogo naznacheniya* (Moscow RVSN 1992) pp 32–33 David Holloway *Stalin and the Bomb: The Soviet Union and Atomic Energy 1939–1956* (New Haven CT Yale University Press 1994) p 129 G A Goncharov N I Komov and A S Stepanov 'The Russian Nuclear Declassification Project: Setting Up the A Bomb Effort 1946' *Cold War International History Project Bulletin* 8 9 (Winter 1996/1997) 4 10–16

46 Zaloga *Target America* pp 70–72

47 A P Romanov and V S Cubarev *Konstruktor* (Moscow Politicheskoy Literatury 1989) p 60

48 Tyulin 'The Seven' Mozhgorin et al eds *Dorogi v kosmos I* p 118 Note that according to Chertok *Rakety i lyudi* p 233 the commission's visit was in February 1946. Another person on the visiting commission may have been B L Vannikov the former Peoples Commissar for Agricultural Machine Building who was currently involved in leading industrial aspects of the nuclear weapons development program. See David Holloway *Military Technology* in Ronald Amann Julian Cooper and R W Davies eds *The Technological Level of Soviet Industry* (New Haven CT Yale University Press 1977) p 455

the artillery sector and had extensive experience in using the solid-fuel Katyusha rockets in wartime conditions.

The commission's visit in May 1946 was instrumental in introducing the role of the defense industrialist, the third major player in the Soviet space program after the aviation engineers and artillery experts. Represented by such individuals as Ustinov and Ryabikov, these defense industrialists would lay their indelible stamp on the rocketry and space sector, molding its activities for the next forty years. Ustinov met Korolev for the first time on this trip and was apparently very impressed with the latter's capabilities. It may have been during this visit that representatives of the commission first informed Korolev that he would be appointed chief designer of all long-range missile development.⁴⁹ OTK Chairman Maj. General Gaydukov's high evaluation of Korolev's work clearly played a critical role in this decision. Korolev himself chose his principal deputy, a man who would figure prominently in the Soviet reach for the Moon. In early 1946, after his short trip to Moscow, Korolev had asked OTK engineer Mishin if he would agree to serve with him back in the Soviet Union. Mishin had declined, at first choosing to return to spend time with his wife and two daughters. Following the May 1946 visit by the Yakovlev commission, Korolev made a second offer, asking Mishin to head a joint Soviet-German design bureau as his deputy, the goal of which would be to create a complete set of technical blueprints for the A-4 based on the drawings captured in Czechoslovakia. By this time, Mishin's family was with him in Germany, and he agreed.⁵⁰ As the head of Plant No. 1 at Sommerda, Mishin assumed one of the leading roles in OTK, and as later events would attest, he clearly impressed Korolev with his assertive nature.

Upon the completion of the Yakovlev commission's short visit in May, the members prepared what would become without doubt the most important decree in the history of the Soviet rocketry and space programs. This decree, the Council of Ministers decree no. 1017-419ss, titled "Questions of Reactive Armaments," was formally signed into law by Stalin on May 13, 1946. The primary effect of the decree was to establish a coordinated governmental mechanism for handling the issue of ballistic and cruise missiles.⁵¹ First and foremost, Stalin sanctioned the formation of a top-secret nine-member Special Committee for Reactive Technology, much like the one for the atomic bomb. The Soviet leader's choice for chairman of the new committee was somewhat of a surprise: Georgiy M. Malenkov, forty-four, who had headed the secret Council on Radar since June 1943, but who had very little experience in dealing with any rocketry or artillery matters.⁵² More curiously, it seems that Malenkov had not been one of the major power brokers in the postwar Stalin leadership, such as Beriya, Molotov, or Voroshilov. As future events would attest, he would eventually become a leading player in upper echelons of the Kremlin, although it would at best be an extremely uneven career ahead. A natural choice for one of the two deputy chairmen of the committee was the thirty-seven-year-old Ustinov, who concurrently served as the head of the Commissariat of Armaments. In 1946, the Commissariat of Armaments was reorganized as part of a general restructuring in the Soviet defense industry, absorbing the military production of the wartime Commissariats (Munitions, Mortars, Medium Machine Building, and Tank Industry), and redesignated the new

49. Konovalov. "From Germany—To Kapustin Yar."

50. Mozzhorin, et al., eds. *Dorogi u kosmos I*, p. 118. Mishin had met Korolev for the first time in Prague in November 1945. See A. Tarasov. "Missions in Dreams and Reality" (English title). *Prauda*, October 20, 1989, p. 4.

51. The complete text of the important decree is reproduced in I. D. Sergeev, ed. *Khronka osnovnykh sobytiy istorii raketnykh voysk strategicheskogo naznacheniya* (Moscow: TsIPIK, 1994), pp. 227–33. The actual Russian word "reaktivnyi" is alternately translated as "reactive," "jet," or "rocket." The word is most commonly used to mean "jet-propelled" as in the Group for Study of Jet Propulsion (GIRD), but in this particular case, "rocket" or "reactive" may be a more appropriate choice.

52. Chertok. *Rakety i lyudi*, pp. 228, 233.

Ministry of Armaments." The other deputy chairman of the committee was Ivan G. Zubovich, forty-five, an expert in electronics who until his new appointment had served as the First Deputy People's Commissar of the Electronics Industry.

Of the other members, certainly the most important was Ivan A. Serov, forty, the Deputy Minister of Internal Security and Beriya's right-hand man. Given the pervasive influence of the state security apparatus in every level of Soviet society and government, it seems that Serov may have actually been the most influential, if not powerful, member of the special committee, serving as Beriya's direct contact on missile issues. Beriya at the time personally kept tabs on the much more important atomic bomb development effort, and it is very unlikely that he would have allowed someone such as Malenkov to have oversight over the rocketry sector. Although official governmental documents of this period give little hint of Beriya's control over *both* the nuclear and rocketry sectors, personal recollections of participants and observers of the early Soviet rocketry program give a different view, emphasizing the direct control that both Beriya and Serov exercised over the missile sector, despite the apparent lack of any formal institutional mechanism.⁵⁴ The only military person on the committee was Marshal Yakovlev, who had headed the visiting commission to Germany in May 1946."

In addition to giving the special committee jurisdiction for overseeing all ballistic and cruise missile efforts, the decree had several other important repercussions. The document specifically called for scientific research and test work, dedicated to the reproduction of the German A-4 guided ballistic missile and the Wasserfall surface-to-air missile, using Soviet materials in the period 1946-48. It appointed Ustinov's Ministry of Armaments as the leading industrial sector to manufacture these vehicles. Several other ministries were tapped to develop and produce such important parts as guidance systems (Ministry of Electronics Industries), gyroscopes (Ministry of Ship Building Industries), liquid propellants (Ministry of Chemical Industries), rocket engines (Ministry of Aviation Industries), and launch complexes (Ministry of Machine Building and Instrument Building)."

Given the fact that the Ministry of Armaments was responsible for developing a variety of weapons systems, a special subsection of the ministry, the Seventh Chief Directorate, was established to handle all ballistic missile research. Ustinov appointed one of his wartime lieutenants, Sergey I. Vetoshkin, forty, to head this directorate." In the interest of providing a large facility from which to direct ballistic missile development, the special committee set aside a factory in Kaliningrad, the M. I. Kalinin Plant No. 88, which had originally been founded in 1866 in St. Petersburg but was transferred to the suburbs of Moscow in 1918.⁵⁸ Throughout the war, the factory had been used for manufacturing artillery weapons and tanks. By an order from Ustinov on May 16, the plant was turned over to form the base of operations for the new Scientific Research Institute No. 88, the central entity in the Soviet Union working on the development of long-range ballistic missiles. Known more commonly as NII-88 (pronounced

53 John McDonnell 'The Soviet Defense Industry as a Pressure Group' in Michael McGwire, Ken Booth and John McDonnell, eds. *Soviet Naval Policy: Objectives and Constraints* (Halifax, NS: Centre for Foreign Policy Studies, 1975), p. 114.

54 See for example Col. Gen. A. Maksimov 'White Crow' (English title) *Krasnaya zvezda*, January 12, 1990, p. 4; Sergey Khrushchev *Nikita Khrushchev krizisy i rakety: vzglyad iznutri*, tom 1 (Moscow: Novosti, 1994), pp. 13-143. Both sources state that Beriya had been responsible for controlling the rocketry sector.

55 The remaining original four members of the special committee were Aksel I. Berg (director of the Institute of Radiotechnology and Electronics), Petr N. Goremkyn (minister of Agricultural Machine Building), Petr I. Kirpichnikov (deputy chairman of Gosplan), and Naum E. Nosovskiy (head of the First Chief Directorate of the Ministry of Armaments). See Sergeev, ed. *Khronika osnovnykh sobyitii*, p. 227.

56 *Ibid.*, pp. 228-29.

57 Yu. Mozhgorin and A. Yeremenko 'From the History of Space Science: From the First Ballistics to II' (English title) *Aviatsiya i kosmonavtika*, no. 8 (August 1991), 34-35.

58 Lardier *L'Astronautique Soviétique*, p. 72.

"nee-88'0, all long-range rocketry for the next ten years was directed from this institution. Maj. General Lev R. Gonor, the forty-year-old wartime head of the famous Barrikady Plant at Stalingrad, was appointed director of NII-88 on August 16, 1946.⁵⁹

At the same time, the primary client for these weapons, the Ministry of Armed Forces, established the Fourth Directorate within its Chief Artillery Directorate. This directorate was heretofore used as the branch of the armed forces handling all procurement, testing, operations, specifications requests, and basic research issues dealing with long-range ballistic missiles. The first chief of the directorate was thirty-five-year-old Maj. General Sokolov, who had led the initial inspection teams into Peenemünde the previous year. Maj. General Gaydukov, the chairman of OTK back in Germany, would serve as Sokolov's deputy." In June, Sokolov and Gaydukov were instrumental in creating the Scientific Research Institute No. 4 (NII-4) within the Fourth Directorate to investigate "the development of methods of testing, acceptance, storage and combat application of missile weaponry." Known secretly as "unit 25840" and located at Bolshevo near Moscow, the first director of the institute was Lt. General Aleksey I. Nesterenko, thirty-eight, yet another of the Katyusha veterans from World War II. Nesterenko was evidently picked for the post in part because of a definitive scholarly work on missile-artillery operations during the war.

The Fourth Directorate was also tasked with two other jobs: proposing a site from which the A-4 and other missiles could be tested and forming a unit of troops specifically for acquiring expertise in preparing and launching these large rockets. For the latter goal, on August 15, 1946, the so-called Special Purpose Brigade of the Supreme High Command Reserve was created within the Fourth Directorate to master the required expertise to use the A-4 ballistic missiles for training and wartime situations. Maj. General Aleksandr F. Tveretskiy, an officer who had served with the ubiquitous Lt. Colonel Tyulin, was appointed the brigade's first commander. Tveretskiy was a curious choice for the post: he had been excluded from membership in the Communist Party because of an incident during the war. When in a rage, he had shot his personal chauffeur. The core brigade was established at Sonderhausen in Germany, where they were sent to first study all available technical documentation on the A-4 to have a thorough knowledge of its capabilities and operational characteristics. Korolev, Pilyugin, and other senior



Maj. General Lev Gonor was the first director of the famous NII-88 institute, which was the focus of all early long-range ballistic missile development in the Soviet Union (files of Peter Gorin)

59 Yu. Mozzhorin and A. Yeremenko "From the History of Space Science: From the First Ballistics to (English title) *Aviatsiya i kosmonavtika* no 7 (July 1991) 40-41 Chertok *Rakety i lyudr* p 234 For a wartime account of Gonors role in the armaments industry see D. F. Ustinov *Vo imya pobedi zapisky narkoma vooruzheniya* (Moscow: Voennoye izdatelstvo 1988)

60 Mozzhorin *et al.* eds *Dorogi v kosmos II* pp 22-88

61 Mozzhorin and Yeremenko "From the History of Space Science" Sergeyev ed *Khronika osnovnykh sobytiy* p 20 The order for the creation of NII 4 was signed by the Council of Ministers on May 13, 1946 and by the Ministry of Armed Forces on May 24, 1946. The institute formally came into existence on June 21, 1946

engineers of OTK were instrumental in coordinating all work with the brigade troops, some of whom later became full-time engineers with different design bureaus. For the most part, the brigade, composed of officers from the Mortar Guards Unit, Artillery, Air Force, and Navy, traveled to and from the major A-4 locations in Germany, learning operating and handling techniques from both the Soviet Vystrel group and the Germans themselves.⁶²

The May 1946 decree also had important repercussions for the work in Germany. The writing clearly stressed the need to completely master aspects of design, production, and testing of the major German missiles, such as the A-4, Wasserfall, Rheintochter, and Schmetterling. A formal plan of action for further work in Germany was requested on the basis of a visit by Ustinov, Yakovlev, and others in the coming weeks. Most importantly, the decree formally stated that the work of OTK in Germany would end in late 1946 with the transfer of all German and Soviet personnel to Soviet territory, primarily to NII-88. At the time, the Special Committee for Reactive Technology concealed this order from the Germans and many of the Soviet engineers working in OTK. Originally, since about late 1945, a major portion of the work in Germany had been focused toward conducting a similar operation to the one the Allies had conducted at Cuxhaven, but by the spring of 1946, all such efforts were discontinued in anticipation of the move to Kaliningrad.⁶³

It is clear both from the language of the decree and concurrent events that the entire operation was subsumed under a cover of secrecy. This was no doubt partly a result of Beriya's control of the sector but also stemmed from the ultimately military nature of the program. Even at this early point, the ultimate purpose of the Soviet effort in Germany was far from clear to the Allies, who were in some cases only kilometers away from the Soviets.

In early August 1946, members of the Special Committee for Reactive Technology officially visited Germany to make a second assessment of the A-4 effort. Arriving at Bleicherode were Marshal Yakovlev, Ustinov, Gonor, Vetoshkin, and two new members of the committee. One of them was Georgiy N. Pashkov, thirty-five, the chief of the rocket technology sector (the "2nd Department") at Gosplan, who had been recently appointed to this new position to serve as a senior advisor to the Communist Party on rocketry management issues." It was evidently clear to most of the hosts at the Institute Nordhausen that Ustinov and Pashkov were both the most powerful and influential members of the visiting commission. On August 9, Ustinov officially appointed the thirty-eight-year-old Korolev as the new "chief designer" of all long-range Soviet ballistic missiles, to dispense his duties as the head of a special department in NII-88.⁶⁵ Korolev's selection for this important position did not come without resistance. Given his time as a Kolyma inmate and the fact that he was for all intents and purposes still an "enemy of the state," there were many in the upper Communist Party ranks who were unwilling to allow him to play such an important role in a top-secret national security program. The first choice to head ballistic missile development was in fact another OTK engineer named Yevgeniy V. Sinilshchikov, whose main focus had been work on the German Wasserfall surface-to-air missiles." It is clear, however, that Ustinov was quite impressed by Korolev's work in Germany, and the recommendation from Gaydukov no doubt sealed his appointment. One of the new chief

62 Tyulin. "The 'Seven'": Sergeev, ed., *Khronika osnovnykh sobytiy*, p. 5, Holloway. *Stalin and the Bomb*, p. 457; Maksimov, ed., *Raketnyye voyska strategicheskogonaznacheniya*, p. 38

63 Tyulin, "The 'Seven'": Sergeev, ed., *Khronika osnovnykh sobytiy*, p. 231

64 Chertok. *Rakety i lyudi*, pp. 171-73. By his own account, Pashkov was appointed in "March or April of 1946." See Mozhzhorn, et al., eds., *Dorogi v kosmos II*, p. 57. The other visiting member was N. I. Vorontsov, a deputy minister of the Communications Equipment Industry

65 Tyulin. "The 'Seven'" Order No. 83-K called for: "The Appointment of Comrade Sergey Pavlovich Korolev as Chief Designer of 'Article No. 1' at the NII-88." "Article No. 1" was the R-1 missile

66 Konovalov. "From Germany—To Kapustn Yar."

designer's first decisions was to appoint Mishin, then only twenty-nine years old, as his "first deputy," a common Russian term for "first among the deputies." On the same day as Korolev's new appointment, Mishin and several others from OTK flew back to Moscow to lay the groundwork for "transferring the set of scientific and technical documentation on the [A-4] rocket into Russian." Mishin served as acting head of the ballistic missiles department at Kaliningrad until Korolev's return from Germany.

For Korolev, his quick reemergence from obscurity and hardship was a vindication of sorts, although it hardly compensated for the trials of the Gulag. Most recent accounts do suggest, however, that he had a very positive attitude about life during his stay in Germany. In May 1946, a few months prior to his new appointment, his wife and daughter had arrived in Germany to visit him, staying through the summer. Korolev relished his newfound freedom, and he tried to make his tour in Germany a holiday of sorts. Between work schedules, he would take the time to drive around the countryside with his family in a state-sanctioned Opel automobile." By this time, his reputation and the idiosyncrasies of his personality had made a great impression on the other members of the Soviet team. Later accounts from his subordinates and peers consistently underline his excellent managerial skills and his insistent emphasis on personal responsibility. Over the years, the latter aspect of his character, while assuming almost mythical proportions, also fostered a genuine feeling of professional workmanship among the engineers in his department. His strong personality and stubborn character also generated fear, not often unfounded. An engineer working under him later recalled that "Korolev was never lenient. He was harsh and hot-tempered. All of us who worked at his design office knew that he was merciless when he saw someone being careless or inattentive." At the same time, he was also known as being extremely kind and giving. Most recollections suggest that he had no hesitation in sharing or giving credit to those who actually deserved it—a precedent that he established during these initial months in Germany during the postwar period. As the weeks wore on, there was almost unanimous belief among Soviet engineers that Korolev was the best man for the job.

New Organizations

The efforts in Germany in 1946 eventually began to split into two different paths. The first of these roads was the cooperative Soviet-German work to prepare several A-4s from parts that had been recovered at Nordhausen and elsewhere. By mid-1946, it was clear that only about a dozen A-4 articles could be produced given the relatively meager leftovers discovered. To extend the potential of using these vehicles both as training missiles and as formal armaments of the armed forces, Korolev at the time was ordered to commence work on a Soviet copy of the A-4, designated the R-1.⁷⁰ The primary difference between the two vehicles was a redesigned tail and instrument compartment to increase the range of the Soviet version. Engineers also used a modified guidance and control system designed not only to nominally increase operational characteristics of the vehicle but also to adhere to production processes in Soviet industry. It was clear, however, to Korolev and the other leading engineers of OTK that creating a Soviet copy of the A-4 would only serve as an interim measure. In fact, Korolev had very little enthusiasm for working on the R-1 project, and this issue may have caused some friction with his superiors. Even at that early stage, he had some major reservations about the

67. Mozzhorin, et al., eds., *Dorogi v kosmos* I, p. 118

68. Romanov, Korolev, p. 213.

69. V. Lysenko, ed., *Three Paces Beyond the Horizon* (Moscow: Mir Publishers, 1989), p. 45.

70. The "R" stood for "raketa," the Russian word for "missile."

limited capabilities and cumbersome operational characteristics of the A-4 rocket, and he considered merely duplicating the missile a waste of time. Prompted by these considerations, in early 1946 at Sonderhausen. Mishin and Budnik had begun early work on an uprated A-4 with a range more than twice as much as its predecessor—that is, 600 kilometers. By the second half of 1946, Korolev and Glushko had already performed "a critical analysis of the missile."⁷¹ Designated the R-2 (and K-1 by British intelligence), the new missile was essentially a stretched A-4 with a new engine designed under Glushko.

It seems that there had been some major German input into these early R-2 studies. In the summer of 1946, Gaydukov had asked the Germans to suggest technical improvements to the A-4 by mid-September. The Germans under Grottrup submitted about 150 recommendations, most of them based on ideas that had been considered by the original Peenemünde team during the war. The Soviet side accepted only half of the list and asked that the rest be studied in more detail prior to a resubmittal. According to the recollections of German engineers, it seems that Korolev had made "as little use as he could of the Germans at Zentralwerke."⁷² Despite the coolness in terms of collaboration, the Germans themselves were apparently very impressed with Korolev's professionalism and courtesy. The latter was reportedly sympathetic to the needs of the German engineers; on one occasion, Korolev himself helped rebuff the Soviet secret police's attempts to harass Grottrup's secretary.

For the Germans, the underlying fear that they would be taken back to the Soviet Union was confirmed in October 1946. On the 21st, Grottrup and several of the leading Germans attended a meeting on possible improvements to the A-4. There was a party for the attendees afterwards, which was rudely interrupted at 4:00 a.m. when the Soviets began their massive operation to transport about 6,000 Germans from various technical industries to the USSR. Each individual was handed a document containing the following passage:

As the works in which you are employed are being transferred to the USSR, you and your entire family will have to be ready to leave for the USSR. You and your family will entrain in passenger coaches. The freight car is available for your household chattels. Soldiers will assist you in loading. You will receive a new contract after your arrival in the USSR. Conditions under the contract will be the same as apply to skilled workers in the USSR. For the time being, your contract will be to work in the Soviet Union for five years. You will be provided with food and clothing for the journey which you must expect to last three or four weeks."

The entire operation was prepared and coordinated by Ivan A. Serov, the Deputy Commissioner of the Soviet Military Administration in Germany and Beriya's point man in the rocketry program. Some engineers, even from the Soviet side, expressed reservations about taking the Germans wholesale back to the USSR. Korolev himself reportedly remarked that "we [the Soviets] must have a little more self-respect."⁷⁴ In the end, the words of Beriya and Serov were final. In the months preceding the transfer, Serov had requested from Gaydukov a list of the most capable German rocketry specialists. Gaydukov returned with 152 names, all of whom, including their families (a total of 495 people), boarded trains for the Soviet Union on October 22 and 23.

71. Tyulin, "The 'Seven'", Chertok, *Rakety i lyudi*, p. 165.

72. Ordway and Sharpe, *The Rocket Team*, pp. 321-23.

73. *Ibid.*, pp. 323-24; Chertok, *Rakety i lyudi*, p. 178.

74. Tokaty, "Foundations of Soviet Cosmonautics": Chertok, *Rakety i lyudi*, p. 177.

By the time the Germans arrived in Moscow, a vast network of institutions was forming around the nerve center of NII-88 at Kaliningrad, about sixteen kilometers north of Moscow. The institute itself, headed by Maj. General Gonor, was divided into three formal structural units:

- A specialized design bureau to design long-range ballistic missiles
- A scientific branch with subdepartments for materials science, stress, aerodynamics, engines, fuels, control, testing, and telemetry
- An experimental plant to manufacture the missiles"

The design bureau was headed by Karl I. Tritko, who had formerly served as the chief engineer of the Barrikady Plant during the war. Tritko was assigned jurisdiction over at least eight departments in the design bureau, each focusing on a particular thematic direction. As the new chief designer of long-range ballistic missiles, Korolev headed Department No. 3, tasked initially with restoring A-4 production.⁷⁶ Vasiliy P. Mishin served as Korolev's first deputy, while two other engineers, Vasiliy S. Budnik and Leonid A. Voskresenskiy, also served as deputies. Konstantin D. Bushuyev, who would go on to direct the Soviet portion of the Apollo-Soyuz Test Project, joined in November 1946 and served as head of the planning sector of the

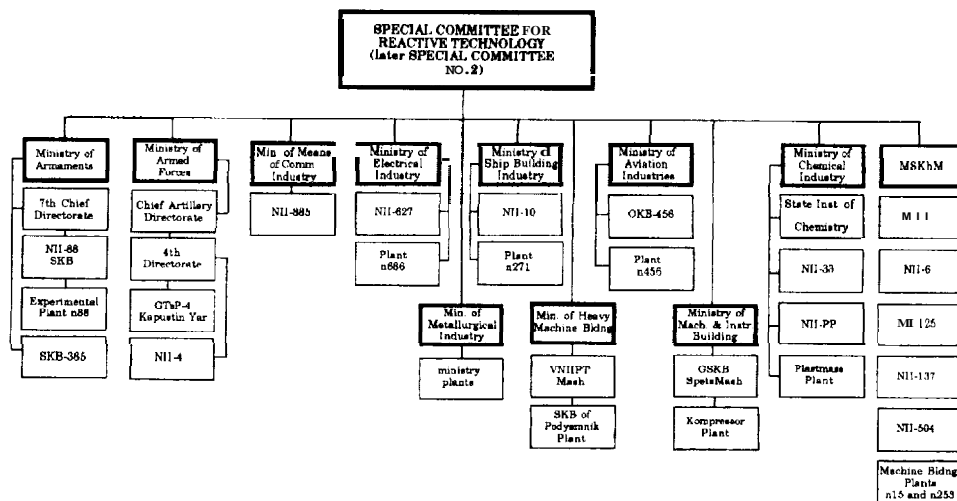

The organization of the Soviet ballistic missile program under the Special Committee for Reactive Technology in the late 1940s (copyright Asif Siddiqi)

75 Mozhzhorin and Yeremenko "From the History of Space Science " The structure of NII 88 was established by Ustinov's order on August 26 1946

76 Mozhzhorin et al eds *Dorogi v kosmos* I pp 67-68 The other known departments were Department No 4 (to develop an anti-aircraft missile based on the German Wasserfall) headed by Ye V Sinilshchikov Department No 5 (to develop an anti aircraft missile based on the German Schmetterling) headed by S Yu Rashkov Department No 6 (to develop an anti aircraft missile based on the German Typhoon) headed by P I Kostin and Department No 8 (to develop liquid propellant rocket engines for the Soviet versions of the Wasserfall and Schmetterling) headed by N L Umanskiy It is clearly evident that at least half of the work at NII 88 was dedicated to efforts other than surface to surface long range ballistic missiles Korolev was officially appointed chief of Department No 3 on August 30 1946

department responsible for all long-range projects." Many of the other engineers who were employed at Department No. 3 went on to head their own design bureaus as chief designers of the Soviet space program in the 1960s and 1970s. Among the major individuals who joined in 1946-47 were Refat F. Appazov, Viktor F. Gladkiy, Aleksandr S. Kasho, Vyecheslav M. Kovtunenko, Dmitriy I. Kozlov, Sergey S. Kryukov, Svyastoslav S. Lavrov, Arkadiy I. Ostashev, Ivan S. Prudnikov, Yevgeniy V. Shabarov, and Georgiy S. Vetrov. At the time of its formation, this department employed sixty engineers, fifty-five technicians, and twenty-five workers.⁷⁸ The successor organization to this small section is known today as the Energiya-Rocket Space Corporation ("RKK Energiya").

The scientific branch of NII-88 was headed officially by the new chief engineer of the institute, Yuriy A. Pobedonostsev, who was Korolev's prewar colleague from the GIRD and NII-3 days." Pobedonostsev oversaw at least five separate departments that focused on specific engineering areas in support of actual design work at the design bureau. Boris Ye. Chertok, the head of department U for guidance systems, served as Pobedonostsev's immediate deputy." There was clearly a visible trend in hiring those who had performed admirably in Germany to important positions in the NII-88 hierarchy, as evidenced by the new posts for not only Korolev, but also Mishin, Pobedonostsev, and Chertok. In spite of Korolev's appointment as chief designer, he was, however, still buried under several levels of the bureaucratic chain. Officially, he was responsible to Chief Engineer Pobedonostsev and then to NII-88 Director Gonor, which naturally set limits as to his influence in institute decisions. These multiple levels of leadership proved to be difficult for Korolev to adjust to, given that back in Germany he had essentially assumed a coordinating role for the entire recovery operation by mid-1946.

The living conditions for those at NII-88 in 1946 were not very conducive to comfort. Even the more senior engineers had to live in "communal apartments" because of the lack of housing. At least half of the employees of the specialized design bureau were in fact on a waiting list for a single room for their families. Most of the workers simply lived in overcrowded barracks and tents, working often through weekends in hastily constructed hangars and "auxiliary structures" at an experimental airfield, which had been given to the institute upon its formation." Instead of working tables, the engineers used equipment boxes for drawings. Manufacturing buildings were in poor conditions, with leaking roofs and puddles on the floor after rainstorms. One engineer remembers that "the heating didn't work, so it was colder inside the shops than outside."⁷⁹ Disease was widespread, and hospital facilities were severely lacking. In addition to their primary job of missile engineering and development, all the engineers had to participate in the building of work facilities, test installations, and even housing. Additional duties involved gardening and assisting the kolkhozes they sponsored. During 1946, at least 1,832 people quit

77 S S Kryukov "K D Bushuyev—Scholar Designer Technical Director of the Soyuz Apollo Program" (English title) in B V Raushenbakh ed *Issledovaniye tvorchestva osnovopolozhnikov kosmonautiki i yeye souremennye problemy* (Moscow Nauka 1989) pp 38-39 Mozzhorin and Yeremenko 'From the History of Space Science

78 Yu Ishlinskiy ed Akademik S P Korolev *ucheniy inzhener chelovek* (Moscow Nauka 1986) pp 514-16 Lardier *L'Astronautique Soviétique* p 73 Mozzhorin et al eds *Dorog v kosmos I* p 170

79 Pobedonostsev was appointed to his new position at the same time as Korolev in August 1946 See Chertok *Rakety i lyudi* p 175 He returned from Germany to take up his post on December 21 1946

80 The other departments were department M for materials (headed by V N Iordanskiy) department P for strength (headed by V M Panferov) department A for aerodynamics and gas dynamics (headed by Rakhmatulin) and department I for testing (headed by P V Tsybin) See *ibid* p 249

81 B Konovalov 'Dash to the Stars' (English title) *Izvestiya* October 1 1987 p 3 Mozzhorin and Yeremenko 'From the History of Space Science'

82 James Harford *Korolev How One Man Masterminded the Soviet Drive to Beat America to the Moon* (New York John Wiley & Sons Inc 1997) p 93

the institute, while the volume of work was always increasing. It was a pace and level of labor that were quite unusual for civilians, even given the poor postwar economic conditions in the Soviet Union. Most of the engineers were in their late twenties or early thirties, fresh from graduation, although in time Korolev managed to recruit some of his old prewar colleagues from NII-3 and even GIRD.

The transfer of the Germans in late 1946 significantly augmented the work at NII-88. On arrival in Moscow on October 28, the 150 or so German rocketry specialists were split into two groups. One group ended up at the new NII-88 Branch No. 1 on Gorodomlya Island in Lake Seliger, about 240 kilometers northwest of Moscow—a remote location that had been witness to some of the most bitter fighting between the Soviets and the Germans. Needless to say, the locals were not very welcoming to the Germans." Dr. Waldemar Wolff and Josef Blass were appointed the German chiefs of the group. The more fortunate of the Germans were transferred to the northeastern section of Moscow to facilitate easier and direct collaboration with engineers at NII-88 in Kaliningrad. Eventually, however, the latter group dispersed; many were assigned to various industrial ministries. It became clearer to the "guests" that the only Germans the Soviets planned to use as a group were the ones at Gorodomlya. The Germans were to focus on six major themes:

- Consultation on creating a Soviet version of the A-4
- Work on "organizational schemes"
- Research in improving the A-4 main engine
- Development of a 100-ton thrust engine
- Assistance in the "layout" of plant production rooms
- Preparation of rocket assembly using German components⁸⁴

Living conditions for the Germans depended greatly on their relative importance and their education. Grottrup's family, for example, was housed in a six-room villa outside of Moscow that had formerly been occupied by a member of the Council of Ministers, and they were provided with a chauffeured BMW automobile. Others were housed according to a system based on the number of members in their families and their academic seniority. The latter criterion in fact determined their pay scales. Those with the equivalent of a Ph.D. degree, such as Magnus Schmidt, and Umpfenbach, were paid 6,000 rubles a month. Those with engineering diplomas, such as Grottrup and Schwartz, were paid 4,500 rubles. The rest received 4,000 rubles a month. By comparison, most of the Soviet engineers themselves were paid much less. Korolev as a chief designer and head of a department was paid 6,000 rubles a month. NII-88 Chief Engineer Pobedonostsev earned 5,000 rubles, while Korolev's first deputy Mishin was paid only 2,500 rubles a month." Most other Soviet engineers were paid much less.

While NII-88 was the primary institute responsible for the design and development of long-range rockets, it was by no means the only one. Unlike the small-scale vehicles developed by GIRD and NII-3 in the 1930s, missiles on the scale of the A-4 used systems that were vastly

83 Ordway and Sharpe *The Rocket Team* p. 325. The German 'guests' at Branch No. 1 were put under the direct command of F. G. Sukhomlinov from the Ministry of Armaments, replaced soon after by P. I. Maloletov who had formerly headed the NII-88 experimental plant. See Chertok *Rakety i lyudi* p. 195. Another source suggests that the first director of Branch No. 1 was V. D. Kurganov.

84 P. Bork and G. A. Sadovoj "On the History of Rocketry Developed in the U.S.S.R. in the First Years After the Second World War (The Participation of German Specialists in the Development of Soviet Missile Technology in the Early Post War Period)" in J. D. Hunley, ed. *History of Rocketry and Astronautics*, Vol. 19 (San Diego: CA Univelt, 1997), pp. 143-52.

85 Chertok *Rakety i lyudi*, pp. 196-97. Ordway and Sharpe *The Rocket Team* p. 325.

more complicated. In particular, the guidance systems, engines, and launch platforms were areas for which NII-88 was forced to collaborate with a number of other important institutes spread across the Soviet defense industry. As with the Ministry of Armaments and its NII-88, other design organizations were under the command of other ministries. On July 3, 1946, the Ministry of the Aviation Industry established the Special Design Bureau No. 456 (OKB-456) at its former Aviation Plant No. 84 in Khimki for the design, development, and production of high-performance rocket engines. Headed by Chief Designer Glushko, the infrastructure and materials at the new design bureau had been transferred wholesale from the Lehesten plant in Germany. Glushko was also able to assemble about 150 of his old colleagues from the wartime days at OKB-SD." Much of the effort at OKB-456 was focused toward testing existing A-4 main engines and facilitating the manufacture of its Soviet-made version, the RD-100.

Guidance and control systems for long-range missiles were handled by several enterprises spread across the Soviet defense industry. The Scientific Research Institute No. 885 (NII-885), under Director Nikolay D. Maksimov in the Ministry of the Communications Equipment Industry, was tasked with the design and development of all autonomous guidance systems, radio control systems, and radiotelemetry systems." Mikhail S. Ryazanskiy, thirty-seven, was appointed the chief designer of radio control systems for all Soviet ballistic missiles, while simultaneously serving as the chief engineer of the institute. With a background in developing radar instruments for naval systems, Ryazanskiy had worked at NII-20 until his arrival in Germany. In early 1947, Nikolay A. Pilyugin, thirty-eight, a veteran of the NII-1/Raketa effort, was named Ryazanskiy's principal deputy for autonomous guidance systems as the chief of the Automation Department.⁸⁸ Both these men had played major roles in the work in Germany and would have a significant influence over future events in both the rocketry and space programs of the Soviet Union.

The development of all-command gyroscope instruments for the long-range ballistic missiles was entrusted to Scientific Research Institute No. 10 (NII-10), in the Ministry of the Shipbuilding Industry, under new Chief Designer Viktor I. Kuznetsov, who was thirty-three. With a background in designing gyroscope instruments during the war, Kuznetsov had also worked in Germany in 1945-46 and based much of his subsequent efforts on the results of this research. The clearly important job of designing launch pads and associated equipment for the missiles was assigned to the State Union Design Bureau of Special Machine Building (CSKB SpetsMash), within the Ministry of Machine and Instrument Building. The appointed chief designer was Vladimir P. Barmin, thirty-seven, who had headed the production of the Katyusha missile launch containers throughout the entire period of the war at the famous Kompressor Plant in Moscow." During 1945-46, Barmin had also served as chief engineer of the Institute Berlin in Germany.

86 Chertok *Rakety i lyudi* pp 196-97 Lardier *L'Astronautique Soviétique* pp 73-74 Until Glushko's arrival the plant had been headed by P. D. Lavrentiyev and was producing Li 2 transport aircraft under license

87 Mozzhorin and Yeremenko "From the History of Space Science" The NII 885 was established on February 26 1938 to develop radio control systems For a short time beginning May 13 1946 this institute was subordinated to the Sixth Chief Directorate of the Ministry of the Electronics Industry and renamed the Scientific Research Institute for Special Technology (NII ST) See K. V. Gerchik ed. *Nezabyuayemnyy Baykonur* (Moscow Interregional Council of Veterans of the Baykonur Cosmodrome 1998) pp 267-68 Maxim Tarasenko 'Evolution of the Soviet Space Industry' presented at the 46th International Astronautical Congress IAA 95 IAA 2 I 01 Oslo Norway October 2-6 1995

88 Yu. A. Mozzhorin et al eds *Nachalo kosmicheskoy ery uospomnaniya veteranov raketno kosmicheskoy tekhniki i kosmonavtiki* uypusk 2 (Moscow RNITSKD 1994) p 279 Lt Gen G. Tyulin "Look Forward" (English title) *Krasnaya zvezda* May 18 1988 p 4 Chertok *Rakety i lyudi* pp 235-333 Pilyugin's Automation Department was the NII 885's Department No. 3

89 Mozzhorin and Yeremenko "From the History of Space Science" Mozzhorin et al eds *Dorogiv kosmos II* pp 50-76



This still from a late-1940s-era film shows the original members of the famous Council of *Chief* Designers. Starting second from *left* are *Chief* Designers Vladimir Barmin, Mikhail Ryazanskiy, Sergey Korolev, Viktor Kuznetsov, Nikolay Pilyugin (standing), and Valentin Glushko. At the far *left* is Boris Chertok, who was a deputy *chief* engineer responsible for guidance systems at NII 88. (copyright Christian Lardier)

Korolev, Glushko, Ryazanskiy, Pilyugin, Kuznetsov, and Barmin each represented the primary areas of development for long-range ballistic missiles. By the last few months in Germany in late 1946, the six had in fact begun to have informal meetings to coordinate overall program goals. After the major organizational changes in 1946–47, they continued these informal contacts. As the programs for missile development began to assume greater levels of complexity, Korolev developed the idea of forming a "Council of Chief Designers" consisting of the six leading chief designers. Established sometime in November 1947, the council was an informal and separate entity from the institutes and design bureaus and eventually assumed engineering control over much of the early development of the Soviet space program.

The original council consisted of Korolev (who was the chairman responsible for overall design), Glushko (rocket engines), Barmin (launch equipment), Kuznetsov (gyroscopes), Pilyugin (autonomous guidance systems), and Ryazanskiy (radio control systems)." One of its outstanding advantages was that it circumvented the normal chain of command in the industry and facilitated swifter and more efficient work. The standard hierarchy in the new missile industry meant that a particular design bureau or institute would be responsible to the specific ministry that had jurisdiction over it. The new council, however, managed to bring together individuals who were officially employed by several different ministries. This was clearly a novelty in the very centralized approach of the Soviet defense industry and illustrated Korolev's early pragmatism and originality in the search for more efficient work.

Apart from the central six organizations involved in the missile sector, there were at least two other major entities that played very significant roles in the formation of the space program. The first was NII-1, the institute that had served as a training ground for so many of the engineers who had ended up under Korolev. On November 29, 1946, a major reorganization in the

90 Col M Rebrov "Council of Chiefs" (English title) *Krasnaya zvezda* April 8 1989, p 3 Pilyugin was technically a deputy chief designer from 1946 until mid-1948 when he was appointed a chief designer

institute was enacted as Mstislav Vsevolodovich Keldysh, a thirty-five-year-old mathematician, was appointed the new director.

Keldysh was born on February 10, 1911, in Riga, Latvia. His passion for mathematics was reinforced by his mentor, the famous Nikolay Luzin, who educated a generation of brilliant Soviet mathematicians. To Luzin's disappointment, Keldysh was more interested in applied fields rather than theory and ended up with a research position at the prestigious N. Ye. Zhukovskiy Central Aerohydrodynamics Institute (or TsAGI). His record was outstanding. In 1938, at the age of twenty-seven, he single-handedly found a solution to "flutter," the sharp increase in vibrations beyond critical flight velocity, after which aircraft would tend to simply fall apart. Later, by the end of the war, Keldysh tackled another difficult problem by discovering a way to avoid "shimmy," a phenomenon discovered by U.S. engineers that caused the front wheel of three-wheeled aircraft to oscillate from left to right upon landing. Keldysh's writings encompassed an astoundingly vast range of scientific areas, including aerodynamics, pure mathematical theory, hydromechanics, vibrations and oscillation, and thermal excitations of sounds. Based on these accomplishments, in 1946, the USSR Academy of Sciences elected the twenty-five-year-old Keldysh to be an Academician, possibly one of the youngest men ever to have such an honor.⁹¹

The primary goal of the reorganized NII-1, still under the jurisdiction of the Ministry of the Aviation Industry, was to examine the Sanger-Bredt antipodal bomber proposal for potential use as an "intercontinental rocket-plane."⁹² A second major theme at the institute was basic research on aerodynamics, ballistics, rocket, and ramjet engines. Several divisions were established within the institute to study these problems, including an aeronautical design bureau headed by former Raketa head Viktor F. Bolkhovitinov and three engine design bureaus. Aleksey M. Isayev, the engineer who had been one of the first Soviets to enter Peenemünde in the spring of 1945, led the first of these engine design bureaus. He had returned from Germany to the Soviet Union in September 1945 to resume his work at NII-1 following a productive period at the Lehesten plant. By all accounts, Isayev was one of the most talented rocket engine designers in the country at the time, and it is more than likely that there was some level of rivalry between Clushko and Isayev at this early stage. Leonid S. Dushkin, tapped to head the second engine design bureau, also focused on rocket engines, while Mark M. Bondaryuk, appointed to the third bureau, led the development of ramjet engines for the Sanger-Bredt bomber. All three were to eventually develop propulsion systems for long-range strategic missiles.

Besides NII-88 and NII-1, NII-4 was the third organization with a major role in the early postwar rocketry sector. Unlike all the other research institutes and design bureaus, NII-4 was part of the Ministry of Armed Forces, the primary *client* for ballistic missiles. Formed at the same time as NII-88, one of those who had ended up at NII-4 was Mikhail K. Tikhonravov, Korolev's old collaborator from GIRD and the designer of the first Soviet liquid-propellant rocket. Tikhonravov had served at NII-1 throughout the war and had spent a short time as part of the inspection commission in Germany, but he was apparently not deeply involved in its activities. Instead, he took part in research on the first postwar Soviet missile dedicated to scientific purposes.

In 1943, the P. N. Lebedev Physical Institute of the USSR Academy of Sciences (FIAN) proposed the development of a rocket designed to reach an altitude of forty kilometers to conduct research on cosmic rays. In April of the following year, while Tikhonravov was still at NII-1, he established a group under Pavel I. Ivanov to develop a missile to satisfy these require-

⁹¹ V. S. Avduyevskiy and T. M. Eneyev, eds., *M. V. Keldysh: izbrannyye trudy raketnaya tekhnika i kosmonautika* (Moscow: Nauka, 1988), p. 7; John Turkevich, *Soviet Men of Science* (Princeton, NJ: D. van Nostrand, 1963), pp. 152-53.

⁹² Yu. V. Biryukov and A. A. Yeremenko, "50 Years for the Native Rocket Space Industry: The Early Period of Development" (English title), *Novosti kosmonautiki* 10 (May 6-19, 1996): 54-64.

ments. A plan for an eighty-seven-kilogram rocket was finished in two months and formally presented to FIAN in December 1944. The design combined several RS-132 solid-propellant Katyusha rockets together into a four-meter-long three-stage vehicle. The rocket was capable of lifting a mass of instruments (just under fifteen kilograms) to an altitude of forty kilometers." Interrupted by Tikhonravov's short stint in Germany, the plan to construct the rocket took longer than expected, but finally in June 1946, Tikhonravov's team and Sergey N. Vernov, a scientist at the Lebedev Physical Institute who had developed the experiments, assembled in Leningrad to launch the so-called VR-210.⁹⁴ The first rocket exploded because of a faulty combustion chamber, the second also failed, and the third, although launched without problems, did not reach the desired altitude. The program was canceled at that point, and Vernov eventually took his experiments to a more well-equipped team, one under Korolev at NII-88.

As for Tikhonravov, when NII-1 was reorganized in November 1946, his group of twenty-three individuals from Branch No. 1 was transferred wholesale to the new military NII-4 in Bolshevo, participating in basic research on the application of long-range missiles for the USSR Ministry of Armed Forces. Staffed and headed mostly by artillery officers, it seems that Tikhonravov's group had been somewhat of an anomaly at the institute given their background in aeronautical engineering. Others who ended up at NII-4 included veterans of operations in Germany, such as Lt. Colonel Tyulin, who would also play a very significant role in the early days of the Soviet space program.

The R-1 and the Antipodal Bomber

Korolev finally returned to the Soviet Union in February 1947, formally taking over his duties as chief designer and chief of Department No. 3 at the NII-88 Specialized Design Bureau. By the time of his return, the investigations in Germany had yielded a massive thirteen-volume work authored by engineers at OTK titled "Collection of Materials for the Study of Captured Reactive Technology."⁹⁵ The Soviet authors were surprisingly cautious in their assessments of the level of advancements achieved by the Germans. While acknowledging significant accomplishments on the part of the Peenemünde team, the study also emphasized the limitations of the A-4. These shortcomings included the overall design of the frame of the missile, the design of the propellant tanks, and the warhead container. The authors did, however, recognize that they had much to learn in the field of guidance system development.⁹⁶

Despite the limitations of the A-4, the Soviet leadership was keen to move ahead with launches of the native-built version of the missile, the R-1, to acquaint Soviet industry with the process of manufacturing and operating a long-range missile. Korolev himself was looking ahead to the much more powerful R-2 rocket based on the earlier work of Mishin and Budnik in Germany. In January 1947, in an official request to the government, he had proposed the immediate commencement of work on the latter vehicle. In response, the government declined

93. Yaroslav Golovanov, *Korolev fakty i mify*. (Moscow: Nauka, 1994), p. 406; Peter Stache, *Soviet Rockets*. Foreign Technology Division Translation, FTD-ID(RS)T-0619-88 (from unnamed source). Wright-Patterson Air Force Base, Ohio, November 29, 1988, p. 206. This is a translation of Peter Stache, *Sowjetischer Raketen* (Berlin: Militärverlag der DDR, 1987).

94. There was an earlier test firing on March 19, 1946, to test the separation of the stages. See Igor Afanasyev, *R-12 Sandalovoye derevo* (Moscow: EksPrint NV, 1997), p. 20. Lardier, *L'Astronautique Soviétique*, p. 77. Another source suggests that the model actually launched was capable of lifting a mass of twenty kilograms to altitudes of fifteen to eighteen kilometers. See V. N. Calkovskiy, "Activities of M. K. Tikhonravov in the RNII (1934-1944)" (English title), *Iz istorii aviatsii i kosmonavтики* 42 (1980): 23-26.

95. Romanov, Korolev, pp. 214; M. V. Keldysh, ed., *Tvorcheskoye naslediyе akademika Sergeya Pavlovicha Koroleva: izbrannyye trudy i dokumenty* (Moscow: Nauka, 1980), p. 395.

96. Stache, *Soviet Rockets*, p. 168.

to approve work on the R-2 and instead opted for a conservative approach focused on the R-1.⁹⁷ Much of the technical details of the R-2 remained in the realm of conjecture at the time, and the project would face a rather circuitous route to formal approval from the Soviet government. As for the R-1 itself, in a letter to the overseeing Special Committee for Reactive Technology, Korolev cautioned that the "creation of the native R-1 missile is not [simply a matter] of copying German technology and substituting their materials with [Soviet] materials."⁹⁸ In other words, it was a note of warning to Soviet leaders that the path to creating such a large missile, given existing conditions, would take the marshaling of a substantial amount of resources. The letter from Korolev prompted the establishment of specific schedule, beginning with launches of the A-4 and then leading into flights of the R-1. Finally, he also called for starting the formal process to create a launch test site for flying the A-4 and R-1 missiles.

In design and appearance, the R-1 was a near copy of the German A-4 missile. The 14.65-meter-long vehicle consisted of four primary elements: the tail assembly, the propellant compartment, an equipment section, and the warhead. The maximum body diameter was 1.65 meters. The lower part of the propellant section incorporated an oxidizer tank container, which carried approximately five tons of liquid oxygen. An insulated feed line was routed from the top tank for four tons of ethyl alcohol. Both containers were self-supporting, separate from the outer shell of the missile, and covered by heat insulation made of glass wool. The twenty-five-ton-thrust RD-100 engine was installed at the base of the rocket with a large turbopump assembly. The equipment section was situated on top of the propellant tanks and contained the guidance system with control and gyroscopic instruments. During flight, the system would control the air rudder at the rear of four large fins at the base of the rocket via servomotors. The explosive warhead was inserted into the nose cone, which itself was attached to the main body of the missile." The total mass of the rocket was about thirteen and a half tons, approximately nine and two-tenths tons of which was propellant. The maximum flight range was about 270 kilometers, slightly higher than the A-4.

Although Korolev himself was the managerial leader of the project, he also contributed extensively to technical aspects of development. Other engineers closely involved in the effort at Korolev's Department No. 3 were Mishin, Abramov, Budnik, Bushuyev, Lavrov, Okhapkin, and Voskresenskiy. The development of the missile also brought into the forefront the operations of the Council of Chief Designers. While the Germans were not involved in any decision-making, they did, however, closely participate in assisting their "hosts" in facilitating the road to the first Soviet tests. For example, German guidance experts at Gorodomlya Island built a simulator for missile trajectories in a month's time, which was sent to NI-88 at Kaliningrad. In addition, a team of twenty German propulsion experts was dispatched to OKB-456 to work with Glushko, although the latter was evidently uninterested in using their talents. The Germans were forced to return to NI-88 soon.¹⁰⁰

At this time, in early 1947, the Soviet leadership had yet to formulate a specific agenda for the new missile industry. Much of the effort in the defense industries was in fact focused on developing the first atomic bomb. A means of delivery, while important, was still clearly secondary. Without a clear idea of what system to pursue for delivery, Soviet Communist Party

97 Yu V Biryukov, "Materials in the Biographical Chronicles of Sergey Pavlovich Korolev" (English title), in B. V. Raushenbakh, ed., *Iz istorii sovetskoy kosmonautiki: sbornik pamyati akademika S. P. Koroleva* (Moscow: Nauka, 1983), p. 226

98. Chertok, *Rakety i lyudi*, pp 205-06

99. Stache, *Soviet Rockets*, p 173; G. A. Sadovoy, "10 October—40 Years After the First Successful Launch of the First Soviet Guided Missile of Long Range R-1 (1948)" (English title), *Iz istorii aviatsii i kosmonautiki* 59 (1989): 94-101.

100 Ordway and Sharpe, *The Rocket Team*, p. 327; Sadovoy, "10 October—40 Years After "

leaders—and in particular Stalin himself—were particularly interested in the old German Sanger-Bredt idea. NII-I engineer Isayev had discovered some documents on this German intercontinental bomber project in May 1945 at Peenemunde; at that time, the projected capabilities of the piloted vehicle had astounded the Soviets.¹⁰¹ The need for a 100-ton-thrust rocket engine in the vehicle no doubt gave pause to any hopes of an early development of the bomber. But caught amid the period's appropriation of German technology, the Soviets were not willing to discard even the most outlandish ideas from their German opponents. A copy of the report was first turned over to NII-I Deputy Director Bolkhovitinov in 1945. The following year, he authored a preliminary study of the vehicle titled "Survey of Captured Technology," which was in fact published in a slim volume by the Ministry of Armed Forces.¹⁰² Initial Soviet assessments of the plan were not encouraging: Bolkhovitinov's deputy Genrikh N. Abramovich, evaluating the proposal, speculated that it would take another decade before the Soviet Union could bring the project to fruition. This pessimistic view does not seem to have affected the aviation sector's interest, and soon after Academician Keldysh's appointment as director of NII-I in November 1946, much of the work at the institute was devoted to the Sanger-Bredt problem. In a document prepared on April 3, 1947, Keldysh for the first time discussed the necessary technical and industrial requirements for creating a 100-ton-thrust engine to power an aircraft.¹⁰³

As Keldysh began research work at NII-I on the bomber, in the spring of 1947, scientists and engineers briefed Stalin on the work on the vehicle. By some accounts, the Soviet leader was unusually enamored of the Sanger-Bredt concept, and he may have in fact been personally instrumental in pushing for an analog Soviet project to produce the intercontinental bomber as a delivery system for nuclear weapons.¹⁰⁴ Several important officials, including representatives from the Soviet Air Force, the Ministry of the Aviation Industry, and the Ministry of Armaments, were on hand to discuss the project with Stalin in mid-April. Unconfirmed reports suggest that there were guarded attempts to caution the Soviet leader about drawbacks in the design's technical details, but that these attempts did not change Stalin's mind. A commission was allegedly established under Col. General Serov, the first deputy chairman of the state security apparatus, to seriously investigate the program.¹⁰⁵ The Sanger-Bredt commission, if it existed at all, may have been an adjunct to the more important Special Committee for Reactive Technology, which had been renamed Special Committee No. 2 by June 1947.¹⁰⁶

Stalin's support notwithstanding, Soviet scientists were not too favorable in their opinion of the piloted antipodal bomber plan. The initial impressions of both Keldysh and Abramovich were not encouraging. Both believed that the project could not be brought to fruition in a short

101. Chertok, *Rakety i lyudr*, p. 91

102. *Ibid.*, p. 93

103. This document has been reproduced as M. V. Keldysh, "On the Development of Research Work on Aircraft With ZhRDs" (English title), in Avduyevskiy and Eneyev, eds., M. V. Keldysh, p. 20. "ZhRD" is the acronym in Russian for liquid-propellant rocket engine.

104. Zaloga, *Target America*, p. 122.

105. Tokaty, "Foundations of Soviet Cosmonautics"; Tokaty, "Soviet Space Technology." The accuracy of both these sources should be viewed with great doubt. Many of the details of the two meetings that the author discusses have serious inconsistencies and historical inaccuracies. The general nature of Stalin's policy on the Sanger-Bredt bomber and the overall tone of the meeting may, however, be fairly indicative of actual events in April 1947. For a detailed Russian analysis and refutation of Tokaty-Tokayev's accounts, see Golovanov, *Korolev*, pp. 392-95. Note that the date given in both the Tokaty sources is March 14, 1947. Based on information from recent Soviet reports, it seems that the meeting was on April 14, 1947. See Golovanov, *Korolev*, p. 396. Among those named by Tokaty-Tokayev as allegedly present were L. P. Beriia, M. V. Keldysh, G. M. Malenkov, A. I. Mikoyan, V. M. Molotov, I. A. Serov, I. V. Stalin, G. A. Tokaty-Tokayev, D. F. Ustinov, K. Ye. Voroshilov, N. A. Voznesenskiy, and A. A. Zhdanov.

106. Mozzhorin and Yeremenko, "From the History of Space Science: II "

Soviet Antipodal Bomber (1947)

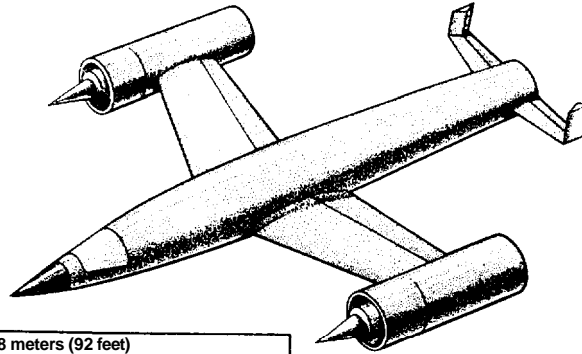

Length	28 meters (92 feet)
Wingspan	15 meters (50 feet)
Propulsion	RDKS-100 100 ton thrust liquid rocket
Sustainer	2 x RNI wing-tip ramjets
Weight	100 tons
Range	12,000 km (7450 miles)

The Soviet version of the Sanger Bredt antipodal bomber shown here as it was conceived in 1947 by the NII I institute headed by Academician Mstislav Keldysh. The rocket plane would have been launched from a special catapult. (copyright Steven Zaloga)

time period given the relatively large leap in technology required. The governmental pressure was, however, insistent enough for Keldysh to write a lengthy report on the bomber in 1947, titled "On Power Plants for a Stratospheric High-Speed Aircraft," which examined in detail the necessary requirements for the creation of an experimental system." The report, prepared under Keldysh's direction at NII-1, described a vehicle clearly reminiscent of the original Sanger-Bredt concept.

The 100-ton winged spacecraft was twenty-eight meters long, with a total wingspan of fifteen meters, and it had a full operational flying range of 12,000 kilometers. The basic vehicle was equipped with three engines, two ramjet units at the tips of the wings, and one traditional liquid-propellant rocket engine at the rear end of the fuselage. As envisioned in the 1947 report, the bomber would be piloted by a single crew member in a special hermetically sealed cockpit at the front of the vehicle. In one of the more original schemes of the plan, the bomber would be launched using a special "catapult" equipped with at least five 100-ton-thrust liquid-propellant rocket engines to impart a total thrust of 500 to 600 tons. for about ten to twelve seconds, accelerating the vehicle to a velocity of about 500 meters per second. At this point, the huge ramjets at the wingtips would fire, working until the vehicle reached an altitude of twenty kilometers, then the main 100-ton-thrust engine at the rear of the bomber would ignite to literally "launch" the bomber into the upper reaches of the atmosphere. A nominal mission would have the bomber fly several "dip-and-skip" trajectories into the atmosphere before reaching the final target."

107 A chapter from the report has been published as M V Keldysh, "On Power Plants for a Stratospheric High-Speed Aircraft" (English title) in Avduyevskiy and Eneyev, eds M V Keldysh pp 22-34

108 ibtd

Active research on the ambitious project began in 1947 under Keldysh's guidance. Apart from playing the overall role of coordinating work on the project, NII-1 also contracted one of its own subdepartments to develop the kerosene-liquid oxygen rocket engine for the catapult and the bomber itself. Leonid S. Dushkin, an engineer who had been an associate of Korolev's in the 1930s, was appointed to lead a team to develop the main engine, designated the RDKS-100. Given the fact that the most powerful Soviet liquid-propellant engine in existence at the time had a thrust of only twenty-five tons, it was quite an ambitious undertaking for Dushkin. NII-1 also at the time commenced an extensive series of experiments, having established laboratories for gas dynamics, combustion, heat exchange, physical methods of measurement, on-board automatic instruments, and a special ground test stand for very high-thrust rocket engines.¹⁰⁹ Research on the two giant ramjet engines was tasked to the Central Institute for Aviation Motor Building in Moscow—an institution that had perhaps the most extensive experience in the Soviet Union in the design of such engines. The actual models would be built in-house at NII-1 under Bondaryuk.

Soviet officials also briefly attempted to involve the Germans in the work on the antipodal bomber. In October 1947, NII-88 Chief Engineer Pobedonostsev forwarded a copy of the original Sanger-Bredt report to the Germans at Gorodomlya. Given the earlier negative assessments from Keldysh and Abramovich, it is not surprising that the Germans had much the same impressions of the proposal. Several major problems were found with the project, including Sanger's claim that the mass ratio of the vehicle would be 0.1. In addition, the Germans postulated that each "skip" into the atmosphere would result in unforeseen gravity loads on the lone pilot and the wing structure, which were not accounted for in the design. They also found problems with the required exhaust velocity, reentry, and choice of a catapult-sled for launching the vehicle.¹¹⁰ Despite the German recommendations, Keldysh and his engineers continued work on this project. In his 1947 report, Keldysh was remarkably optimistic, suggesting that based on NII-1's calculations, "it would be possible to create a combined propulsion unit with liquid rocket engines and supersonic [ramjets] ensuring a range of 12 thousand kilometers for the rocket plane."¹¹¹ Research at the institute focused on those areas in which there were inherent weaknesses in Soviet technology, such as the development of high-temperature resistant metals and high-thrust propulsion systems. Such was the interest in the bomber that Stalin reportedly dispatched an Air Force officer name Grigoriy A. Tokaty-Tokayev in 1948 to kidnap Dr. Sanger, who was at the time living in France. Unfortunately for the Soviet leader, Tokaty-Tokayev took the opportunity to defect to the West, thus providing a key source for information on the Soviet antipodal bomber effort.¹¹²

Kapustin Yar

Korolev's February 1947 letter to Special Committee No. 2 accelerated the process to select a missile test site for testing the A-4 and R-1 rockets. The committee, in cooperation with the General Staff of the USSR Ministry of Armed Forces, had initially settled on a location on the Azov shore, with launch routes taking the missiles over the Don steppes toward Stalingrad. Ukrainian Communist Party First Secretary Nikita S. Khrushchev was evidently opposed to such a move because of the possibility of "resettling" a large amount of people from the Ukraine. Khrushchev took the matter directly to Stalin, who asked Beriya to look elsewhere.¹¹³ On July

¹⁰⁹ Lardier, *L'Astronautique Soviétique*, p. 69.

¹¹⁰ Ordway and Sharpe, *The Rocket Team*, p. 329.

¹¹¹ Keldysh, "On Power Plants for a Stratospheric High-Speed Aircraft."

¹¹² See G. A. Tokaty-Tokayev, *Comrade X* (London: Harvill Press, 1956), for an account of his defection.

¹¹³ Khrushchev, *Nikita Khrushchev*, pp. 107-09.

27, 1947, from nine other choices, the committee selected a desolate area ninety kilometers southeast of the town of Volgograd on the banks of the Akhtuba River, a tributary of the Volga. Officially designated State Central Range No. 4 (GTSP-4), the place was informally called Kapustin Yar and covered a ninety-six-by-seventy-two-kilometer stretch of desert land. The name came from a legend that described a robber named Kapustin who had found refuge in the small village. The primary motivations for selecting Kapustin Yar were its remoteness from populated areas, its closeness to established railway tracks, and its proximity to the major industrial center of Volgograd. In addition, the railroad from Stalingrad to Kapustin Yar did not go through a single population center, thus isolating the new project from curious citizens. Apart from selecting a site, the July decree also formalized two other issues. The first launches of German and Soviet-built A-4 missiles were set for the period September–October 1947. Furthermore, Lt. General Vasilii I. Voznyuk, a forty-year-old artillery officer who like many others in the new rocketry sector had participated in the operation of the Katyushas during the war, was appointed the first commander of the range.¹¹⁴

The construction of the modest launch facilities at the desolate area began at the height of summer in late July and early August 1947. The conditions were terrible, as Voznyuk later recalled:

Barren steppes. A little vermouth. Thorn bushes, occasionally some wolf's milk. Little water. Transport after transport arriving with construction worker[s] who had become famous for their efforts during the . . . war. Transports and matériel and equipment arrived. Families arrived. Where were they to be housed? As it turned out in tents and, at best, in small settlements located along a small stream whose water had too high a salt content to be used for drinking water. Sand, gravel, and bricks for building, water and food for personnel had to be brought in."

Some of the engineers from NII-88 and elsewhere were housed in special trains that served a multipurpose role. Most had live in tents or in the village houses of the local inhabitants, who were none too pleased with this sudden intrusion into their lives. The temperature in summer was as high as forty degrees Centigrade, while in winter it was known to drop to as low as minus thirty degrees. Although spring did bring a temporary respite from the extreme weather conditions, the workers then had to cope with deadly snakes and tarantulas.¹¹⁵ Necessities, such as water, food, clothing, and shelter, were not by any means taken for granted, and there were several fatalities.

In anticipation of the first launches in the fall, Soviet and German engineers, artillery officers, defense industrialists, secret police representatives, and Communist Party officials poured into Kapustin Yar and were housed in rail cars and tents. Korolev and several of his leading deputies arrived in early October at the same time as a number of notable dignitaries. These included Chief of Chief Artillery Directorate Marshal Yakovlev, Minister of Armaments Ustinov, Chief of the Seventh Chief Directorate Vetoshkin, and Deputy Minister of State Security Serov.¹¹⁷ For the series of launches, the Soviet government set up a temporary administrative body called a "State Commission," whose members were the leading officials involved in the tests. Entities

114 Mozzhorin, et al., eds., *Dorogi v kosmos II*, pp 76–77. Jacques Villain, ed., *Batkonour la porte des étoiles* (Paris: Armand Colin, 1994), p. 44, D. V. Shatalov, "The History and Formation of the First Soviet Cosmodrome Kapustin Yar," presented at the 48th International Astronautical Congress, IAA-97-IAA.2 2 01, Turin, Italy, October 6–10, 1997.

115 Stache, *Soviet Rockets*, p. 171; Tyulin, "The 'Seven'."

116 Villain, ed., *Baikonour*, p. 44

117 Boris Konovalov, "Soviets Rocket Triumphs Started in Germany: II" (English title), *Izvestiya*, March 7, 1992, p. 5; Mozzhorin, et al., eds., *Dorogi v kosmos II*, p. 78.

similar to the State Commission for A-4 Launches were quite common in the Soviet defense industry, existing only temporarily to certify each stage of testing of a new weapons system, such as tanks, aircraft, and rockets. By bringing together individuals from different institutional boundaries, governmental agencies could make more effective assessments of the capabilities and limitations of weapons. Eventually, decades later, the same principle would come into use in the Soviet space program.

Marshal Yakovlev, the head of the Chief Artillery Directorate, was a natural choice for the post of chairman of the State Commission for A-4 Launches. Officially, his deputies were Ustinov and Serov, although in actuality, much like the policy-making Special Committee No. 2, Serov probably played a pivotal role in the new commission's operations.¹¹⁸ Numerous German engineers, including Grottrup, Hoch, Klippel, Magnus, Meier, and Munnich, also traveled to Kapustin Yar in early fall to serve as coordinators for the launches, although they were not official members of the State Commission. They were well acquainted with most of the equipment at the range because a large amount of it had been directly collected at Lehesten and Peenemunde. The actual launch "pad" itself was served by special railcar built under the guidance of Grottrup in Kaliningrad. A "consultant" group of Germans for launch operations was headed by Fritz Viebach. Apart from the Germans, a small active Soviet launch group was also established to directly conduct the tests.¹¹⁹ A total of about 2,200 personnel were present for these historic launches at Kapustin Yar.

There were two different series of A-4s prepared for launch, each comprising nine rockets. The first, designated "series N," had been built by the Germans at the Klein Bodungen plant and tested horizontally at Mittelwerk. The "series T" consisted of those built and assembled using primarily German and some Soviet parts at NII-88 plant at Kaliningrad, near Moscow. The first launch of an A-4 missile from Soviet soil took place at 1047 hours Moscow Time on October 18, 1947, more than a year after the first U.S. A-4 test. The series T rocket lifted off successfully, and as a result of clear weather, viewers saw the rocket for a few minutes. The A-4 impacted some 206.7 kilometers from the launch point, a distance of thirty kilometers to the "left" of its intended target point.¹²⁰ Initially unaware of the guidance system failure, there was almost pandemonium at the launch site when it was announced that the missile had flown the full intended range. Ustinov held Korolev in a bear hug and engaged in a celebratory dance with him. Korolev and Grottrup also hugged each other in congratulations.¹²¹ The second launch on

118 The complete State Commission was Marshal N. D. Yakovlev (Chief of the Chief Artillery Directorate) D. F. Ustinov (Minister of Armaments) I. A. Serov (First Deputy Minister of Interior Affairs) S. N. Shishkin (Deputy Minister of Aviation Industries) N. I. Vorontsov (Deputy Minister of Communications Equipment Industry) V. P. Terentyev (Deputy Minister of Ship Building Industry) V. I. Vinogradov (Deputy Chief of Rear Services and Chief of Staff of Rear Services of the Ministry of Armed Forces) N. I. Kochnov (Deputy Minister of Machine Building and Instrument Building) M. P. Vorobyev (Chief of Engineering Forces of the Ground Forces) M. K. Sukov (Chief of the Chief Directorate of the Oxygen Industry of the Council of Ministers) S. I. Vetoshkin (Chief of the Chief Directorate of Reactive Armaments of the Ministry of Armaments) and P. F. Zhigarev (Deputy Commander in Chief of the Air Force) See Vladimir Ivkin and Aleksandr Dolinin "They Were the First" (English title) *Krasnaya zvezda* October 31, 1997 p. 2

119 Sergeyev ed. *Khronika osnovnykh sobytii* p. 34. This team included brigade officers Major Ya. I. Tregub (chief of launch command) and Captain N. N. Smirnitkiy (launch operator). Korolev's Deputy for Testing L. A. Voskresenskiy (launch operator on behalf of the engineers) NII 88 Deputy Engineer B. Ye. Chertok and NII 885 Deputy Chief Designer N. A. Pilyugin. Others in the group included Lieutenant A. P. Bachurin, Captain V. D. Boykov, Lieutenant C. V. Dyadin, Pilyugin's deputy A. M. Ginsburg, and Captain V. I. Menshikov. See Mozzhorin et al. eds. *Dorogi v kosmos II* p. 78.

120 Chertok *Rakety i lyudi* pp. 186-87, 192-93. Igor Yemelyanov "This Yar Wasn't So Easy to Come by: Our First Space Launch Facility Hears the Rockets Less and Less Often" (English title) *Komsolskaya pravda* November 26, 1993 p. 3. Tyulin "The Seven "

121 Ordway and Sharpe "The Rocket Team" p. 333.

October 20, also of a series T vehicle, was more of a disappointment. During the active part of the trajectory, the missile deviated sharply to the left and disappeared into the clouds. After a few seconds, an announcement came over the speakers, with some element of humor, that the missile had "fallen in the region of Saratov," a densely populated region."

The State Commission immediately met, and Serov asked that all efforts be made to ascertain the possibility that the A-4 had indeed landed at Saratov. Because the request came from Serov, the rocket builders took the order correctly as a veiled threat to their jobs. Eventually, after tense minutes, investigators discovered that the rocket had actually landed not in Saratov, but elsewhere, about 180 kilometers from the intended target. Ustinov immediately decided to consult German specialists on the problem. Two of them, Magnus and Hoch, were instrumental in determining the cause of the guidance failure, allowing the tests to proceed. The last A-4s, the tenth and eleventh missiles, were successfully launched the same day. November 13, completing the historic first long-range ballistic missile launches in the Soviet Union. Of the total launched, five were built at Nordhausen and six at NII-88. The record of tests showed that all were launched successfully, although only five reached their designated targets.¹²³

These first A-4 tests were also important for facilitating the first high-altitude scientific research in the Soviet Union. Scientists at the P. N. Lebedev Physical Institute of the USSR Academy of Sciences had been disappointed when the postwar VR-210 project had failed to produce any fruitful results. Aware of the R-1 effort at NII-88, Sergey N. Vernov, the nuclear physicist at the institute, was instrumental in trying to create a rapport between scientists and the engineers at NII-88, including Korolev. As a result, in 1948, the special Commission for the Study of Stratosphere, whose work had been on hold during the war, was revived. Academy President Sergey I. Vavilov met formally with Korolev that year to discuss a plan of operations for allowing scientists to design payloads for the R-1 missiles. By the fall of 1947, a modest experiment regime involving the study of cosmic rays had been prepared. The nose section of a few A-4s were equipped with an ionization chamber and a gas discharge counter with appropriate shielding; the main equipment section of the missile was modified to hold electronic instruments for the amplification, conversion, and coding of signals, which were all connected using a cable with antennae at the rear of the rocket. The actual cosmic ray detectors were attached between the rear fins of the A-4.¹²⁴ The total scientific payload mass was about 500 kilograms. The first of three of these "scientific" launches was conducted on November 2 in the presence of Dr. Vernov, the chief experimenter and at the time the deputy director of the Scientific Research Institute for Nuclear Physics. The missile reached an altitude of eighty kilometers, providing about three minutes of good data."

The launches at Kapustin Yar in 1947 were clearly significant events in the history of the Soviet rocketry and space program. Having recovered only a handful of A-4s from the wreckage left behind by the Peenemünde group, it was a tribute to both the Soviet and German engineers involved that full-scale launches of these rockets, most of them successful, were resumed in such a short period after the end of the war. Unlike the U.S. military, which was able to capture 100 A-4s, the Soviets suffered from the limitation of having recovered approximately one-

122 Chertok, *Rakety i lyudi*, p. 192, Kononov. "Soviets Rocket Triumphs Started in Germany. II -

123. Biryukov, "Materials in the Biographical Chronicles of Sergey Pavlovich Korolev." p. 226; Mozzhorin, et al., eds., *Dorogi v kosmos II*, p. 79; Chertok, *Rakety i lyudi*, pp. 192-93. An assessment of the A-4 launches is also given in Sadovoy, "10 October—40 Years After"

124. Stache, *Soviet Rockets*, p. 208; Biryukov, "Materials in the Biographical Chronicles of Sergey Pavlovich Korolev." p. 226.

125 Lardier, *L'Astronautique Souretique*, p. 76. See also Stache, *Soviet Rockets*, p. 208. For Vernov's role, see L. L. Layko, "11 June—80 Years From the Birth of Soviet Scholar S. N. Vernov (1910)" (English title), *Iz istorii avtatsii i kosrnonautikr* 64 (1990), 48-54.

fifth of that number. Given the vast number of A-4s that were brought to the White Sands Proving Ground in New Mexico, the U.S. Army rapidly launched twenty-five of them in rapid succession in 1946 under the first phase of Project Hermes.¹²⁶ Assessing and identifying weaknesses in the A-4 design, the military was able to capitalize on the early tests and move on to more advanced programs. The Soviets, on the other hand, limited by the number of A-4s they could launch, simply opted to create their own homemade version, the R-1. Thus, the results of recovery operations by the Soviet Union and the United States in Germany in 1945 had a direct effect on the nature of immediate postwar rocketry efforts.

The Debate Over the R-2

Korolev supported the 600-kilometer-range R-2 missile project throughout 1947, but that project seems to have faced many delays from various sources. Initially proposed as early as January 1947, Stalin did not seem too keen on the project, given that the A-4s had yet to fly at the time. A meeting of the Scientific-Technical Council of NII-88 was held on April 25 to 28, 1947, at Kaliningrad in the presence of Minister of Armaments Ustinov. This allowed Korolev to formally "defend" the R-2 draft project."

The R-2 missile was a significant advance over the German-based predecessor. The basic external structure of the R-2 was somewhat reminiscent of the A-4, but the new missile had a range twice that of the R-1. The corresponding increase of dry mass was only about 500 kilograms, while the increase in length was about two and a half meters. Korolev's engineers incorporated at least four major innovations into the vehicle to achieve the given performance. One of the two propellant tanks of the missile, the one carrying ethyl alcohol, was incorporated as an integral part of the overall structure of the rocket, often called a "monocoque" design. Engineers had to learn to master the complex thermal processes on the exterior of the vehicle because of such a scheme, which itself contributed to changing internal pressure in the tank. A monocoque design for the liquid oxygen tank was deemed too complex because of the uncertainties in its behavior in flight, although research was already ongoing on the means to incorporate such practices in succeeding designs. The second major design improvement was the use of a separable warhead, making it possible to have a much lighter rocket body, because thermal insulation would prove to be unnecessary for the main body after the separation of the warhead and the missile. This problem posed one of the greater challenges for Soviet engineers and required research on coordinating the separation of the two parts, elements of the trajectories, precise knowledge of engine performance, and stabilization of the nose section following separation. The R-2 also had a much improved guidance system, developed in cooperation with groups under Chertok, Pilyugin, Ryazanskiy, and Kuznetsov, which would allow increased targeting accuracy and also provide easier access during prelaunch operations to decrease the time required for preparing launches. Finally, the missile would use an updated version of the R-1's RD-100, designated the RD-101, with a thrust of thirty-five tons, and developed at OKB-456 under Chief Designer Glushko. The new engine was achieved by increasing the concentration of ethyl alcohol and raising combustion pressure.¹²⁸ While the total length of the new missile

126. Andrew Wilson. *The Eagle Has Wings. The Story of American Space Exploration: 1945-1975* (London: BIS, 1982). p. 2; Ordway and Sharpe. *The Rocket Team*. pp. 353-54. A total of sixty-four A-4s were launched between April 16, 1946, and September 19, 1952, from White Sands.

127. Biryukov. "Materials in the Biographical Chronicles of Sergey Pavlovich Korolev," p. 226; Tyulin. "The 'Seven'." This was the first-ever meeting of the Scientific-Technical Council of NII-88. See Yu. A. Mozhzhonn. "The Central Scientific-Research Institute for Machine Building—The Chief Center of the Soviet Rocket-Space Industry" (English title). *Iz istorii aviatsii i kosmonavtiki* 60 (1990): 20-40.

128. Keldysh, ed.. *Tvorcheskoye naslediyе akademika Sergeya Pavlovicha Koroleva*. p. 544; Stache. *Soviet Rockets*, pp. 175-77. The R-2 also had a new telemetry system named Don.

was 17.65 meters, the maximum body diameter was the same as the R-1, 1.65 meters. The total fueled mass was fifteen and a half tons.

The engineers froze the basic design elements of the R-2 plan by April 1947. Although the technical improvements were theoretically sound, the engineers did face serious problems translating their plans into reality. Among the major factors were the severe lack of raw materials and the absence of many important industries, such as advanced metallurgy, which had to be built from scratch. The industrial infrastructure for manufacturing the myriad of parts was almost nonexistent at the time, and engineers often had to scrounge through their own possessions for items such as springs and screws. The issue of quality control would also become a very important issue given the expenses associated with losing complete missiles because of faulty assembly. Finally, the Soviets were forced for the first time to create ground testing infrastructure for testing key elements of the missile prior to launches. One of the first dedicated engine testing facilities was established in July 1947 as Branch No. 2 of NII-88, about seventeen kilometers north of Zagorsk near Moscow, initially under the leadership of Gleb M. Tabakov.¹²⁹ The R-1's RD-100 was the first engine fired on static stands at the branch, while units for surface-to-air missiles developed at the NII-88 were also among those tested during 1947-48.

The development of the R-2 missile ran into serious problems soon after the April meeting. On June 4, 1947, NII-88 Director Maj. General Gonor hosted another meeting to discuss the long-range goals of the German specialists affiliated with the institute. At the meeting, Grottrup, the leading German rocketry specialist in the Soviet Union, proposed the development of a new missile designated the G-1 (later to be confusingly called the R-10) as a successor project to the R-1. Not surprisingly, there was a much resistance on the part of Soviet engineers to any German proposal that was competitive with their own plans. In this case, the G-1, with a range of 600 kilometers, had capabilities and design elements very similar to Korolev's R-2. The latter was particularly stubborn in his opposition to the G-1 plan. One of his closest associates, NII-88 Deputy Chief Engineer Chertok, later recalled that Korolev's resistance was based more on personal reasons than any technical considerations. Having suffered through the humiliation of the Great Purges, he had watched the Soviet rocketry effort crumble while the Germans had advanced swiftly with their ambitious A-4s. His hostility to the Germans and their designs in part contributed to his vigorous opposition to creating the R-1 copy of the A-4, a matter that resulted in significant friction with Minister of Armaments Ustinov.¹³⁰ The industrial leaders of the missile industry, in the person of not only Ustinov, but also Ryabikov, Vetoshkin, and others, were evidently in favor of allowing the German engineers a free reign in their design projects. This high level of support was crucial in ensuring that Grottrup's team could accelerate their work on the G-1 after the June meeting. To the dismay of Soviet engineers, relevant departments at the institute were subordinated to the Germans to assist them in their calculations in the ensuing months. It is quite likely that Korolev's engineers investigated the design characteristics of many of the German design characteristics for the G-1 for their relevance to the R-2 project, but ultimately the "German diversion" seems to have siphoned off resources for work on the Soviet R-2 missile, delaying its overall progress.

A preliminary draft plan for the German G-1 was discussed at a meeting of the Scientific-Technical Council of NII-88 on September 25, 1947. Present were the Germans Grottrup, Umpfenbach, Hoch, Albring, Anders, Wolff, and Sheffer, along with Chief of the Seventh Chief Directorate of the Ministry of Armaments Vetoshkin and NII-88 Chief Engineer

129. Mozzhorin, *et al.*, eds., *Dorogr v kosmos. II*, pp. 64-65. Other sources state that first head of Branch No. 2 was V. S. Shachin.

130. Chertok, *Rakety i lyudi*, pp. 199-200.

Pobedonostsev." Korolev himself was not in attendance, but he was represented by two of his deputies. Mishin and Bushuyev. The design that the Grottrup team presented to the leadership of the institute had a number of similarities to the Soviet R-2, including the use of a separate payload section for the warhead and the 600-kilometer range for the missile. There were also major differences between the two vehicles. Both the liquid oxygen and ethyl alcohol tanks on the G-1 had a monocoque structure made of very thin aluminum or steel, unlike the R-2, which only had one monocoque tank. The Germans increased engine thrust to thirty-two tons by adopting innovative methods for regulating propellant flow rates. A mass saving of about 180 kilograms was achieved by dispensing with the high-test peroxide generator in favor of using gases diverted from the combustion chamber to turn the turbopumps. The guidance and control systems for the G-1 were also relocated at the base of the missile in contrast to the forward end on the A-4. Finally, the guidance system would use a then-sophisticated method known as "beam-riding," which essentially transferred a major portion of such systems to ground stations, thus saving mass on the rocket itself. The missile looked similar to the A-4, with a length of 14.3 meters and a total mass of 18.6 tons. According to Grottrup, the new design would allow vastly increased targeting precision, a much shorter launch preparation time, and twice as much range compared with the A-4. The payload mass would also rise from the A-4's 0.74 tons to a new peak of 0.95 tons."

Grottrup made a very persuasive case to the NII-88 leadership, and he asked for formal approval of the G-1 project, shrewdly proposing that both the R-2 and the G-1 be allowed to proceed in parallel and completely independently of each other. Many of the Soviet engineers predictably put up resistance. Mishin, one of the authors of the Soviet R-2, argued that the institute had two possible roads: exploiting the current technology available and developing a missile (the R-2), which had a real possibility of being created in a short time, or developing a rocket (the G-1), which would necessitate a radical restructuring of the existing Soviet testing and manufacturing base.¹³¹ In its final decision, the council of the institute, while mentioning the several attributes of the G-1, declined to approve a full-scale program to develop the G-1, instead asking that Grottrup's group present a formal and complete "draft plan" for the missile at a following meeting.¹³⁴ It was evidently a means to delay decisive action on the German project and, in an overall sense, a policy on the use of German expertise in the rocketry industry in the Soviet Union. The decision pleased no one and clearly indicated that the leadership of the Ministry of Armaments, in particular Ustinov and Vetoshkin, were at odds with the engineers in their view on the use of German engineers in the Soviet missile program. The matter was obviously a very sensitive issue. While most Soviet officials were reluctant to use German expertise, many were amenable to compromise on the issue to accelerate the development of ballistic missile technology in the Soviet Union. Formally establishing a mechanism for doing this was much harder. Korolev could clearly not be expected to work under Grottrup, while if the roles were reversed, Korolev would no doubt exclude Grottrup's group from all work. A third alternative was equally unpromising: allowing two parallel and independent development projects, which was well outside the capacity of funding at the Ministry of Armaments.

131. Among the others present were V. I. Kuznetsov (NII-10 Chief Designer), M. S. Ryazanskiy (NII-885 Chief Designer), B. Ye. Chertok (NII-88 Deputy Chief Engineer), A. M. Isayev (NII-1 Chief Designer), M. K. Tikhonravov (NII-4 Deputy Director), V. A. Trapeznikov (Automation Institute of the USSR Academy of Sciences Director), A. A. Kosmodemyanskiy (N. Ye. Zhukovskiy Engineering Academy Professor and Special Committee No 2), and G. A. Nikolayev (Rector of the Bauman MVTU). See *ibid.*, p. 202.

132. CIA Office of Scientific Intelligence, *Scientific Research Institute and Experimental Factory 88 for Guided Missile Development. Moskva/Kaliningrad*, OSI C-RA/60-2, March 4, 1960, p. 7; Ordway and Sharpe, *The Rocket Team*, pp. 329-31; Chertok, *Rakety i lyudi*, pp. 202-04; Bork and Sadovoj, "On the History of Rocketry"

133. Chertok, *Rakety i lyudi*, p. 204.

134. An excerpt from the original document is reproduced in *ibid.*, p. 207.

Immediately after the September 1947 meeting, the Germans were given a temporary lift; there was a subtle shift in favor of their G-1 plan. It was to be a relatively short time to celebrate victory. Although the Germans spent the better part of 1948 working on the G-1 project, there were some unexpected institutional changes. Beginning in the early months of the year, the Soviets began relocating all of the remaining Germans to Gorodomlya Island in Lake Seliger. Grottrup himself left Moscow to join NII-88's Branch No. 1 in February. By May, almost all of the Germans had departed the main institute offices at Kaliningrad, and few were ever to visit again. The Germans also later reported that their pay rates were significantly reduced. In addition, Grottrup's position in the German hierarchy was called into doubt by a combination of Soviet hostility and internal struggle among the Germans themselves. The pace of work on the G-1 dramatically decreased in 1948, as Grottrup began to raise formal complaints with his Soviet bosses, arguing that only a few of the planned experiments on the project had been allowed to proceed."

The Germans may have lost their access to Kaliningrad, but this did not accelerate a final definitive decision between the Soviet R-2 and the German G-1. Korolev's long battle over the R-2 had actually begun more than a year before when he had taken the matter to Stalin himself. On April 14, 1947, he was escorted into the Kremlin to meet the Soviet leader in person for the first time.¹³⁵ Over the years, Korolev gave wildly contradictory accounts of that meeting. In a rare interview with a Soviet journalist in 1963, he remembered:

I had been given the assignment to report to Stalin about the development of the new rocket. . . . He listened silently at first, hardly taking his pipe out of his mouth. Sometimes he interrupted me, asking terse questions. I can't recount all the details. . . . I had a short . . . synopsis report which I was not allowed to take with myself. Stalin replied with a greeting but did not offer his hand. Stalin was outwardly restrained. I could not tell whether he approved of what I was saying or not. [He] said "no" enough times that these "no's" became the law for the moment. These were the conditions [of the meeting]."

In a letter to his wife written after Stalin's death in 1953, Korolev recalled that he was very nervous at the meeting, which was attended by many others, including Minister of Armaments Ustinov. Stalin apparently paced around his office during the entire hour, asking many pointed and pertinent questions about the state of the missile program.¹³⁸ One of those attending was Korolev's first deputy, Vasily P. Mishin, who remembers:

¹³⁵ *Ibid* pp 210-11; Ordway and Sharpe *The Rocket Team* p 335

¹³⁶ The actual date of Korolev's meeting with Stalin has been the subject of some speculation. An in-depth analysis is included in Golovanov *Korolev* pp 390-98 in which the author concludes that the meeting took place in 1949. The evidence for 1947, 1948, and 1949 is equally compelling. In an interview in 1963, Korolev mentioned 1947 as the year, whereas Tyulin's recollections set it in 1948. See Tyulin "The Seven." Finally, Golovanov argues based on the remembrances of Chief Designer Kuznetsov that it was in 1949. In a letter to his wife from 1953, Korolev remembered the exact date as March 9 without naming a year.

¹³⁷ Romanov *Korolev* pp 10-11. This interview was held on November 30, 1963, by TASS correspondent A. P. Romanov. Many censored and altered versions of the interview were published over the years in different publications. The complete unexpurgated text was finally allowed to be published in 1996 in Romanov *Korolev* pp 5-20. For one 'censored' version of the interview see Ivan Borisenko and Alexander Romanov *Where All Roads Lead to Space Begin* (Moscow: Progress Publishers, 1982) pp 40-43.

¹³⁸ Golovanov *Korolev* p 391-92.

CHALLENGE TO APOLLO

I can remember that [Stalin] walked around the room smoking his pipe, breaking *papyrosi* [cigarettes] and putting tobacco in. There were about a hundred people there — marshals, ministers, officials of the Party. It was in the building of the Central Committee and the subject was liquid rockets. Stalin was a strong supporter of their development. The U.S. had naval bases in Europe. owned the A-bomb. They didn't really need the ICBM. They could reach the USSR with bombers."¹³⁹

The Soviet leader asked Korolev about his impressions on the comparative uses of rockets versus bombers in wartime situations. to which Korolev summarized the possible advantages of the former. After the end of the meeting, Korolev, on request from Stalin, wrote up a short report on the spot on the rockets-versus-bombers discussion and departed.¹⁴⁰ The influence of Korolev's report is still open to interpretation. The chief designer himself recalled somewhat ambiguously:

This meeting played its positive role. Apparently Stalin and his military advisers seemed to understand that the first experiments at designing jet aircraft, artillery units, and other things could in the future produce *far-reaching positive results*.¹⁴¹

One of Korolev's goals at the meeting had evidently been to convince Stalin of the need to move ahead with the longer range R-2 missile. The Soviet leader declined to approve such a strategy, electing to maintain focus on the Soviet copy of the German A-4 missile. It would be exactly a year before the Council of Ministers formally adopted a decree on the future of the missile program. Dated April 14, 1948, the resolution called for the development, testing, and use of the R-1 missile in the Soviet Union. The same document sanctioned "scientific and experimental work" for the eventual creation of the 600-kilometer-range R-2 missile.¹⁴²

Stalin's decision no doubt gave some impetus to Korolev's arguments against the G-1. The continuing battle between the German and Soviet proposals continued throughout the year as the Germans prepared a huge and detailed draft plan for their missile. The conflict between the R-2 and the G-1, however, took a hiatus in the fall of 1948 as Soviet engineers once again trekked to the steppes at Kapustin Yar for the very first launches of a Soviet-made long-range ballistic missile. Unlike the earlier A-4 tests in 1947, this time none of the Germans were invited, a clear indication of their isolation from the mainstream Soviet program. The test program for the R-1 envisaged two separate series of launches, the first consisting of about a dozen vehicles primarily to verify the correctness of the newly introduced industrial design and manufacturing methods in the Soviet Union. The second series, to consist of about twenty missiles, would be flown to increase reliability and eliminate defects that would show up in the first series.¹⁴³ The construction of the first flight articles began in May 1948. While the missiles were officially referred to as R-1, in all technical documentation, the vehicle was designated "product 8K1 I." a style of nomenclature, using a number-letter-number system, that would be continued into the space era.

The State Commission for testing the R-1 missiles was chaired by Chief of the Seventh Chief Directorate of the Ministry of Armaments Vetoshkin. His deputy on the commission was Maj. General Sokolov, the head of the Fourth Directorate of the Chief Artillery Directorate, who

139 Harford. *Korolev*. p. 234.

140 Golovanov. *Korolev* p. 396. Tyulin. "The 'Seven' "

141 Romanov. *Korolev*. p. 11; Nicholas Daniloff, *The Kremlin and the Cosmos* (New York: Alfred A. Knopf, 1972), p. 97, A Romanov, *Spacecraft Designer. The Story of Sergei Korolev* (Moscow. Novosti Press Agency. 1976). p. 27

142. Chertok. *Rakety i lyudi*. p. 310: Sadovoy. "10 October—40 Years After "

143. Sadovoy. "10 October—40 Years After "

was responsible for the hundreds of artillery personnel involved in the program. Korolev was the only engineer who was a formal member of the commission, although the five other individuals in the Council of Chief Designers served as technical advisors.¹⁴⁵ The first two launch attempts in mid-September had to be postponed because of equipment failures. The third vehicle, the first to get off the launch pad, flew into the skies on September 17, but suffered a major control systems failure.¹⁴⁵ Almost immediately following liftoff, the R-1 veered fifty-one degrees off its main trajectory, flew nearly horizontal to the ground, and landed only ten kilometers from the launch site. The engineers apparently quickly determined the cause of the malfunction, for a second R-1 was launched soon after. This one also failed, this time because of a malfunction in an oxygen valve in the engine's combustion chamber. The R-1 finally lifted off on its first successful flight on October 10, 1948, traveling a full range of 288 kilometers and attaining a top velocity of 1,530 kilometers per second. A second partially successful launch took place three days later. After these tests, Ustinov and Marshals Yakovlev and Voronov arrived at Kapustin Yar as observers, lending an unusual importance to the tests.¹⁴⁶ As with the A-4 launches in 1947, agents from the state security apparatus sent by Col. General Serov were on hand at the testing ground, providing a general feeling of uneasiness to all the proceedings. Weather was also a problem and at least one of the launches, on November 1, had to be postponed because of heavy fog. In addition, a technician was killed while checking a newly designed gangway to the missile. The final R-1 vehicle was launched on November 5, the ninth successful flight out of twelve launches.¹⁴⁷

The nine launches that were deemed successful were classified on the basis of the achieved range, about 300 kilometers on each flight. The accuracy of the missiles, however, left much to be desired. Only one of the vehicles impacted in the designated sixteen-by-eight-kilometer target area, raising serious concerns about the missile's possible use in battle. The poor record of the launches instigated a minor altercation between Ustinov and Marshal Yakovlev, representing different interests of the Soviet government.¹⁴⁸ The latter, speaking for those that would eventually use the missile as a weapon, was not pleased about the outcome of the launches. It was a debate that would continue for several years until the Soviet missile finally outgrew its connection to the German A-4 missile. In retrospect, these launches comprised a critical period in the development of the future Soviet missile and space industry; many new technologies were introduced in the production process. New techniques, such as those for the manufacture of large sheets of special magnesium steels and magnesium alloys, and new types of cables, relays and sensors, and materials-handling machinery were developed for the R-1. In addition, the Ministry of Armaments concurrently created assemblies for the storage and transporting of liquid oxygen with refueling equipment, and it also developed new methods for welding and protective coatings for the R-1 warheads.¹⁴⁹ These industries, a total of thirty-five Scientific

144 The other members of the State Commission for the R-1 were: Lt. Colonel V. I. Voznyuk (Commander of the GTS-4), Maj. General L. R. Gonor (Director of the NII-88), and industrial representatives G. I. Muravyev, V. N. Tretyakov, S. M. Vladimirov, and Yeremeyev. Additional technical advisors were G. I. Degtyarenko and M. I. Likhovitskiy. See *ibid.*; Chertok, *Rakety i lyudi*, p. 313.

145 Biryukov, "Materials in the Biographical Chronicles of Sergey Pavlovich Korolev," p. 227; G. A. Kustova, ed., *Ot peruogo Sputnika do "Energii" - "Burana" i "Mira"* (Moscow: RKK Energiya, 1994), p. 6.

146 Biryukov, "Materials in the Biographical Chronicles of Sergey Pavlovich Korolev," p. 227; Lardier, *L'Astronautique Soviétique*, p. 80; Chertok, *Rakety i lyudi*, pp. 317-19.

147 Kononov, "Soviets Rocket Triumphs Started in Germany: II" Note that another source suggests that there were nine launches, of which only one (on October 10) reached its target. See Yu. P. Semenov, ed., *Raketno-Kosmicheskaya Korporatsiya "Energiya" imeni S. P. Koroleva* (Moscow: RKK Energiya, 1996), p. 32.

148 Golovanov, Korolev, pp. 402-03; Sadovoy, "10 October—40 Years After."

149 Mozzhorin and Yermenko, "From the History of Space Science". Mozzhorin and Yermenko. "From the History of Space Science II"

Research Institutes, and eighteen manufacturing plants later facilitated the relatively quick and efficient production of larger and more powerful missiles.

Korolev and his engineers returned from Kapustin Yar to Kaliningrad in time to hear the revised report by the German engineers on their G-1 study. On December 18, 1948, the members of the Scientific-Technical Council of NII-88 gathered to make a final decision on the German proposal. Sitting in for the absent NII-88 director was Maj. General Aleksey S. Spiridinov, an artillery officer who had hitherto served as a liaison contact between the Germans and the Soviets. The entire German "high command," including Grottrup, Albring, Blass, Hoch, Muller, Rudolf, Umpfenbach, and Wolff, were in attendance. Representing the Soviet assessment team were Bushuyev, Isayev, and Lapshin from NII-88 and Chief Designer Glushko from OKB-456. Once again, Korolev was absent, perhaps to preclude the Germans from acquiring information on the real power behind the ballistic missile program. In his report, Grottrup announced that his group, over the course of the past year, had managed to increase the design range of the G-1 from 600 kilometers to 810 kilometers and had also dramatically increased targeting accuracy. Dr. Hoch, the author of the new guidance system, also expounded on the advantages of the new redesigned missile. After a long and sometimes acrimonious session, punctuated for the first time by a discussion of the political implications of using German expertise, the council formally terminated the parallel approach of work on the R-2 and the G-1, which had been continuing for close to two years by then. Instead, taking what was considered "decisive" action, the institute leadership did not approve creation of the G-1, although Spiridinov explained that the Germans would be allowed to continue work on their coveted missile.¹⁵⁰

It was an extremely significant decision that had a profound effect on the role of the German group on the further development of long-range ballistic missiles in the Soviet Union. The Germans continued to work on several more major rocketry projects, but none played as major a role in Soviet planning as the G-1. Work on that effort was continued into 1949 as Grottrup's group focused on structural aspects and the Doppler radio system of the missile.¹⁵¹ By then, however, it was increasingly clear that the future did not hold much promise. As the Germans settled into studying further missile projects in the ensuing years, each one raised hopes that the Soviet side would finally give them the green light to create their first rocket in metal.

Stratonauts and Multistage Rockets

Mikhail K. Tikhonravov, the man who had designed the first Soviet liquid-propellant rocket, the O9, had, as with many of the other engineers of NII-3, moved from project to project, first because of the Purges and then as a result of the war. After Korolev's arrest in 1938, the two did not work together in any capacity, and their efforts moved in different paths. The older of the two—he was forty-five years old at the end of the war—Tikhonravov had established a group at NII-1's Branch No. 2 during the last years of the war to develop a solid-propellant rocket for scientific experiments. When this project, the VR-210, failed to yield any positive results, he threw his lot into a much more ambitious plan, one with which he had been toying since at least the late 1930s.

In early 1945, Tikhonravov brought together a group of engineers at the institute to work on a design for developing a high-altitude rocket for carrying two passengers to an altitude of

¹⁵⁰ Chertok, *Rakety i lyudi*, pp. 212, 218; CIA Office of Scientific Intelligence, *Scientific Research Institute*, p. 7.

¹⁵¹ Ordway and Sharpe, *The Rocket Team*, p. 335

190 kilometers." Designated the VR-190 proposal, it was the very first concrete project in the Soviet Union for launching humans into space. Tikhonravov's plan envisioned the use of a modified A-4 rocket with a recoverable nose cone containing a pressurized cockpit for carrying two "stratonauts."¹⁵³ The passengers would remain in an upright position in the capsule from launch until touchdown in two custom-made couches. Tikhonravov formulated four primary goals for the project:

- To conduct research on the effects of the temporary weightlessness on humans during free-fall
- To carry out investigations on shifts in the center of gravity in the cabin and the movement of the center of gravity subsequent to the separation of the nose cone from the main rocket
- To acquire information on the density, pressure, and temperature of the upper atmosphere
- To test the operational reliability of instruments for separation, descent, stabilization, and landing of the cockpit

Tikhonravov even went so far as to contract out the development of the special two-passenger cabin for the VR-190 to a designer, A. V. Afanasyev, at OKB-115, an organization led by the famous Soviet aviation designer Aleksandr S. Yakovlev. Work on a parachute system for the recovery capsule began simultaneously in May 1946.

Many of the design aspects of the VR-190 were remarkably advanced for the time. In his conception of the spacecraft, Tikhonravov proposed the use of the following:

- A parachute system for returning to Earth
- A braking rocket engine for soft landing the cabin on the ground
- A system using explosive bolts to separate the cabin from the launcher
- A special probe extended downward beneath the cabin to serve as a sensor to trigger the soft-landing engines
- A pressurized cockpit with fully equipped life-support systems, thus bypassing the need for a catapult or ejection seats
- A system of low-thrust attitude control engines to maneuver the vehicle during its vertical trajectory beyond the atmosphere

Remarkably, all six of these design elements would be adopted for Soviet piloted spacecraft by the early 1960s. More impressively, Tikhonravov proposed the use of an "arched" protective heat shield, a design not unlike the one used today on the Soyuz spacecraft.¹⁵⁴

Not wanting his idea to languish from a lack of interest, Tikhonravov tried to elicit interest from authorities all the way at the top of the Soviet leadership. In June 1946, he and his deputy, Nikolay G. Chernyshov, authored a letter to Stalin on the VR-190:

¹⁵² This group included N. C. Chernyshov, V. N. Galkovskiy, P. I. Ivanov, A. F. Krutov, C. M. Moskalenko, and V. A. Shtokolov.

¹⁵³ V. N. Galkovskiy and C. M. Moskalenko, 'The VR-190 Project—A Step in the Road to the Creation of Space Ships' (English title) *Iz istorii aviatsii i kosmonavтики* 42 (1980): 28–30; Yevgeniy Ryabchikov, 'A Russian Story: In One Moment Sputnik Became Part of the Vocabulary of Mankind: The Beginning of the Space Era Revealed' (English title) *Ogonek* 40 (October 3–10, 1987): 1–3; Stache, *Soviet Rockets*, pp. 257–58.

¹⁵⁴ *Ibid.*

*Dear Comrade Stalin! We have developed a plan for a high-altitude Soviet rocket for lifting two humans and scientific apparatus to an altitude of 190 kilometers. The plan is based on using equipment from the captured V-2 missile, and allows for realization in the shortest time . . . for returning, the cabin has load-bearing parachutes. [and] a braking unit in the form of [liquid propellant rocket engines], installed together with its propellant tanks at the base of the cabin. . . . The practical realization of the project would be possible, given the creation of the required conditions, in close to a years time! . . .*¹⁵⁵

At the same time, Tikhonravov also collated his group's research and presented the results to the Collegium of the Ministry of the Aviation Industry, the supervising authority over NII-1. Reactions from both Stalin and the ministry were remarkably positive. The bureaucrats all nodded with approval at the plan and gave the project "a positive review and recommendation." while Stalin himself wrote back that "the proposal is interesting—please examine for its realization."¹⁵⁶ Unfortunately, it seems that bureaucratic gridlock killed the effort. Because of "a number of organizational difficulties," the Ministry of the Aviation Industry never set about funding the idea, and Tikhonravov's report ended up in the ministry's library "gathering dust."¹⁵⁷ One can imagine aviation minister Shakhurin's views on piloted spaceflight given his complete and total noninterest in rocketry in general.

In late 1946, NII-1 was reorganized to carry out dedicated work on the Sanger-Bredt antipodal bomber, and consequently Tikhonravov's group at its Branch No. 2 was transferred to another military institute, NII-4, at which scientific research was geared completely for purposes of defense. NII-4 itself was soon brought under the umbrella of a new entity, the USSR Academy of Artillery Sciences. Established on October 11, 1946, this academy, under Lt. General Anatoliy A. Blagonravov, was formed to provide an institutional setting for educating a new generation of artillery experts in the technical theories of long-range ballistic missiles.¹⁵⁸ For the Tikhonravov group, work at NII-4 was initially focused on other unrelated areas, and they were forced to follow up engineering work on the VR-190 plan in their own spare time.¹⁵⁹ Surprisingly, it seems that this first

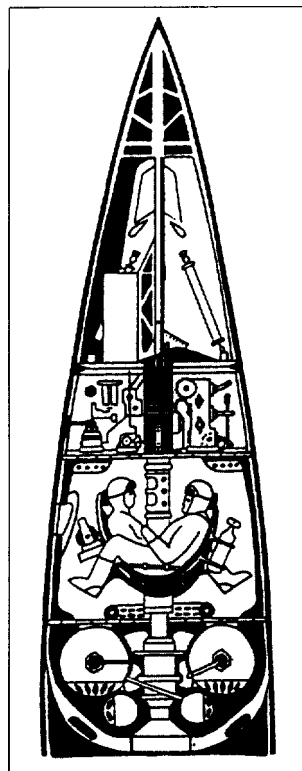

A drawing of the VR-190, the very first Soviet conception of a piloted spacecraft in the postwar era. Conceived by Mikhail Tikhonravov at NII-1 in 1945, the VR-190 would carry two "stratonauts" strapped in an upright position on a 200-kilometer "hop" into the upper atmosphere. Many design innovations from the project were later used in the 1960s-era spacecraft, such as Voskhod and Soyuz (files of Asif Siddiqi)

¹⁵⁵ Valeriy Baberdin, "Military Space Started Here and Not Only Military" (English title). *Krasnaya zvezda*, April 30, 1994, p. 4

¹⁵⁶ *Ibid.*: Anatoliy Shiryayev and Valeriy Baberdin, "Before the First Leap Into Space" (English title). *Krasnaya zvezda*, April 27, 1996, p. 5; Galkovskiy and Moskalenko, "The VR-190 Project"

¹⁵⁷ Shiryayev and Baberdin, 1996; Galkovskiy and Moskalenko, "The VR-190 Project."

¹⁵⁸ CIA, *Soviet Capabilities and Probable Programs in the Guided Missile Field*. NIE-1 1-6-54, October 5, 1954, p. 29; Mozzhorin, et al., eds., *Dorogi v kosmos II*, p. 91.

¹⁵⁹ Stache, *Soviet Rockets*, p. 258; Lardier, *L'Astronautique Soviétique*, p. 77

piloted space effort had not been coordinated with NII-88 and in particular Korolev's group. The two had evidently discussed the project in mid-1945, but Korolev was clearly engaged in more earthly pursuits at the time, and he was not about to set off on a somewhat farfetched adventure only one year after his release from confinement. In addition, Korolev was a little more hesitant than Tikhonravov in believing that piloted spaceflight would be facilitated by ballistic missiles. Given Korolev's interest in rocket-powered airplanes, this is not so surprising. From the early 1930s on, he had preferred the rocket airplane as a means to explore the upper atmosphere. It was only in the immediate postwar years that there was a fundamental shift in his strategy, perhaps prompted by the successes of the German A-4 missile.

The changes with NII-1 and NII-4 slowed down the VR-190 project, and by early 1947, much of the early momentum had been lost. That same year, Tikhonravov withdrew from work on the project, and the program was delegated to a different subdivision in the institute. Redesignated a "rocket probe" and given a "different tenor," the VR-190 plan was pursued further by others, and in 1948, a preliminary plan for the project was presented for tentative approval by the Scientific-Technical Council of NII-4.¹⁶⁰ The council allowed further work on the project with one modification—the launch of humans in the plan was dropped in favor of using dogs. The following year, the institute finally terminated the project, possibly motivated by Korolev's own plans to modify the R-1 into a missile for scientific purposes. Thus ended the first serious investigations in the Soviet Union in the interest of piloted spaceflight. The issue would not be taken up again for several years.

Tikhonravov's move to a new sector of NII-4 in 1947 (the "first sector") as a deputy director of institute precipitated a second major first for the Soviet rocketry program: serious investigations into the possibility of designing very powerful ballistic missiles that could be used to potentially launch artificial satellites. The same year, on September 16, he established a small group under Pavel I. Ivanov at the institute to conduct research on the development of multistage rockets. Although not specifically stated as such, the rationale for conducting the study, at least on Tikhonravov's part, was to develop a satellite launch vehicle in the near future using available Soviet technology. The responsibility of exploring the details of various possible configurations of multistage long-range ballistic missiles was assigned to Vladimir A. Shtokolov and Igor M. Yatsunskiy, two young engineers in Tikhonravov's employ who had both worked on the VR-190. In December 1947, the group produced a preliminary report, which included analyses of several different variants of so-called "composite" missiles, in which stages would be discarded following the depletion of propellant, the overall mass of the booster would be lightened, and consequently velocity would be increased.¹⁶¹

Utilizing the ground-breaking theories of Tsiolkovskiy, Ivanov's group under Tikhonravov's direction studied two possible variants of combining stages into one multistage booster. The first was a "tandem" arrangement, with two stages attached successively, and the second was the "cluster" scheme, with various stages connected in parallel. Despite the apparent simplicity and elegance of the tandem scheme, the engineers saw at least two major drawbacks in that variant. First, Tikhonravov believed that the problems of developing a rocket engine to fire in vacuum, as would be required for a tandem configuration, might prove to be insurmountable

160 I. M. Yatsunskiy "On the Activities of M. K. Tikhonravov in the Period From 1947 to 1953 on Substantiating the Possibility of Creation of Composite Missiles" (English title) *Iz istorii aviatsii i kosmonavtrk* 42 (1980) 31-38. An English title of this is available as I. M. Yatsunskiy "The Role of Mikhail Klavdiyevich Tikhonravov in Creating Stage Rockets 1947-1953" in John Becklake, ed. *History of Rocketry and Astronautics*, Vol. 17 (San Diego: American Astronautical Society, 1995), pp. 451-56. See also Stache, *Soviet Rockets*, pp. 258-59.

161 B. N. Kantemirov "15 July—40 Years From the Report of M. K. Tikhonravov on the Possibility of Achieving Cosmic Velocity Using the Current Level of Technology" (English title) *Iz istorii aviatsii i kosmonavtiki* 59 (1989) 65-76. Yu. V. Biryukov "Memorable Dates" (English title) *Novosti kosmonavtrk* 13 (June 16-29, 1997) 68-70.

in the coming years. Second, the extra length of a tandem arrangement of stages would also pose complicated manufacturing problems. These factors prompted Ivanov's group to focus on cluster-staged rockets in which all the stages would fire at liftoff. In such a design, the length of the missile would be much less than a tandem variant, in fact being equal to the longest rocket forming the cluster. Several variations of the cluster arrangement were studied, including one with identical boosters linked together and one with differently sized rockets connected together in parallel. A further design, called "missile complexes," envisioned the use of several boosters connected together in parallel, each of them being a multistage vehicle *itself*.¹⁶² Because of the absence of electronic computers, the team performed all the mathematical calculations by hand, although this apparently did not slow down the group's work.

In December 1947, Tikhonravov produced a preliminary report on the topic, which specified configurations and capabilities of both tandem- and cluster-type long-range missiles. In the following months, Shtokolov and Yatsunskiy carried out hundreds of calculations that began to show the advantages of the cluster scheme, which by this time was given the name "packet." In their work, the two engineers examined a broad range of topics, including the means to link up the various rockets in parallel, possible ways to separate the strap-ons, and also ballistics for the active part of the trajectory. In their formal documentation, the researchers made no mention of a satellite launch vehicle, although the work was clearly aimed at achieving orbital velocity. Tikhonravov's engineers were not the only individuals at NII-4 involved in space-related themes. The institute's deputy director for science, Maj. General Yakov B. Shor, focused on a traditional successively staged missile, while institute Director Maj. General Nesterenko, Chernyshov, and others were also participants in "discussions" on space themes.¹⁶³

In early 1948, despite the fact that the results of the study on packets were still somewhat preliminary, Tikhonravov orally presented a summary of the investigations to the Scientific-Technical Council of the institute.¹⁶⁴ The reception of his proposal was divided. The less than supportive response did not deter Tikhonravov, and he decided to present the paper, now titled "Paths to Accomplishing Great Ranges by Firing Missiles," at the annual meeting of the Academy of Artillery Sciences, the overseeing authority over NII-4. Despite Nesterenko's apparent support, Academy President Blagonravov was not easily convinced of the propitiousness of allowing a presentation of the paper. Fully aware of Tikhonravov's ideas of a satellite launch vehicle, Blagonravov told Tikhonravov: "The topic is interesting. But we cannot include your report. Nobody would understand why. . . . They would accuse us of getting involved in things we do not need to get involved in. . . ." ¹⁶⁵ Tikhonravov was not easily discouraged and requested a follow-up meeting with Blagonravov the next day. This time, the Blagonravov agreed to the request, warning Tikhonravov: "Be prepared—we will blush together."¹⁶⁶

On July 14, 1948, Tikhonravov read his report at the Academy of Artillery Sciences in the presence of a large group of prominent dignitaries from the military.¹⁶⁷ Apart from Blagonravov and Nesterenko, Chief Designer Korolev was also present, on visit from NII-88. The audience listened in pin-drop silence to Tikhonravov's speech "with tremendous attention" as he argued persuasively that the design of rockets capable of reaching very high altitudes and velocities was technologically feasible. Not surprisingly, the reaction of most of the audience was negative. One high-ranking military official reportedly said, "The institute must not have [had] much to

162. Kantemirov, "15 July—40 Years". Yatsunskiy. "On the Activities of M. K. Tikhonravov."

163. Mozzhorin, et al., eds., *Dorogi v kosmos II*, p. 91

164. Kantemirov, "15 July—40 Years."

165. Yaroslav Golovanov. "The Beginning of the Space Era" (English title). *Praudo*. October 4, 1987, p. 3

166. *Ibid*

167. Yatsunskiy. "On the Activities of M. K. Tikhonravov" For a complete reproduction of Tikhonravov's paper, see M. K. Tikhonravov, "Paths to Accomplishing Great Ranges by Firing Missiles" (English title). *Iz istorii i kosmonautiki* 67 (1995): 3–26.

do and decided to switch to the realm of fantasy?"¹⁶⁸ Korolev was one of the very few who reacted positively, telling Tikhonravov after his presentation: "We have some serious things to talk about. . . ."¹⁶⁹ For Korolev, it was a small opening for his own nascent dreams of space exploration. As plans for new longer range missiles to follow the R-2 were beginning to emerge at NII-88, Tikhonravov's bold report clearly served as a catalyst for combining the disparate efforts at the two different institutions.

The political climate, and especially the fear of the secret police in the late Stalin era, no doubt also played a major role in any decision on the part of Tikhonravov or Korolev. Given the job of creating a long-range ballistic missile for the Soviet armed forces, Korolev was not about to jeopardize his job and perhaps even his life by making hasty diversions into what the secret police no doubt considered a pointless endeavor. In Tikhonravov's case, his work on packet-based long-range rockets was continued into the following year only to face near cancellation. For reasons still unclear, the leadership of NII-4 disbanded Ivanov's subdivision in early 1949. Put into a difficult position, Tikhonravov entrusted one member of his team, Yatsunskiy, to persevere with this theme.¹⁷⁰ The latter by this time was employed in a different sector of the institute, thus considerably slowing down work on Tikhonravov's project because of institutional barriers.

Despite the sudden shutdown of this important work, Tikhonravov's landmark July 1948 speech served as a catalyst for intensive cooperation between himself and Korolev. The two had known each other since 1927, when they had met as young glider pilots, working together through the 1930s at GIRD and NII-3. In the postwar years, although officially at two different organizations, they reestablished an informal but pivotal communication between each other. Prompted by the initial satellite launch vehicle studies at NII-4, it seems that Korolev had decided to take the matter in his own hands and approach the Soviet leadership with a proposal to fund the launch of an artificial satellite in the near future. It was probably clear to him that neither Blagonravov nor Nesterenko had the political clout to handle such a request, and he opted to instead appeal to Soviet leader Stalin himself. It was a risky decision to take, but clearly underlines Korolev's true interests. His group at NII-88 may have been officially working on military rockets, but it is apparent from the many descriptions of Korolev's life in those years that he never lost sight of the ultimate objective of space exploration. As it turned out, Tikhonravov's early but ambitious studies at NII-4 on launch vehicles, artificial satellites, and human spaceflight laid the basis for unexpected opportunities of which Korolev would soon take advantage to realize his dream of space exploration.

168 Colovanov "The Beginning of the Space Era "

169 *Ibid*

170 Yatsunskiy "On the Activities of M. K. Tikhonravov "



CHAPTER THREE

STALIN AND THE ROCKET

The first long-range ballistic missile launches during 1947–48 served as watershed events in the early history of the Soviet rocketry program. Within three years of the end of the war, the Soviets had managed to establish a level of capability at least equivalent to wartime German accomplishments, while at the same time initiating ambitious studies on artificial satellites, launch vehicles, and even a short-lived program to lob humans on vertical trajectories. The problems, both technical and institutional, remained paramount, but allowed the engineering faction, led primarily by NII-88, to identify several useful avenues for further investigation. The ensuing years, between 1949 and 1953, would prove to be even more critical; research was focused on a number of important studies dedicated to advancing the capabilities of the A-4-derived Soviet missiles. The rate of progress in the rocketry program was astonishing; by the end of that four-year period, the Soviets had almost completely left behind the German antecedents of their missile program and moved into the realm of intercontinental ballistic missile (ICBM) development, effectively laying the foundation for the birth of the Soviet space program.

Testing at Kapustin Yar

The overriding motivation for the new Soviet ballistic missile program was obviously military, but over the years, a small but vigorous scientific element of high-altitude rocketry research began to emerge. Primarily because of the efforts of nuclear physicist Sergey N. Vernov, Deputy Director of the Scientific Research Institute for Nuclear Physics, the work of the Commission for the Study of the Stratosphere had been revived in the postwar years. To facilitate the design and development of instruments for flight on board A-4-derived missiles, NII-88 Chief Designer Korolev met with USSR Academy of Sciences President Sergey I. Vavilov in 1949 to coordinate this effort. Following their consultations, Vavilov entrusted the organizational problems of this field of research to Academician Keldysh, who, in turn, used the existing Stratosphere Commission to establish in late 1949 the new Commission for the Investigation of the Upper Atmosphere.¹ He appointed Academician Blagonravov, the President of the USSR Academy of Artillery Sciences, as this commission's chair and assigned to him all

¹ Yu. V. Biryukov "Materials in the Biographical Chronicles of Sergey Pavlovich Korolev" (English title) in B. V. Raushenbakh ed. *Iz istorii sovetskoy kosmonavtiki: sbornik pamyati akademika S. P. Koroleva* (Moscow: Nauka, 1983), p. 229. According to one source, the Commission for the Coordination of Work for the Research of the Upper Layers of the Atmosphere was established on February 18, 1953. See L. A. Vedeshin, "18 February—25 Years From the Day of Creation of the Commission of the USSR Academy of Sciences for the Coordination of Work on Research on the Upper Atmosphere (1953)" (English title) *Iz istorii aviatsii i kosmonavtiki* 35 (1978): 24–26.

duties concerning the coordination of a formal scientific offshoot of the Soviet ballistic missile program. By that time, under Korolev's leadership, Department No. 3 at NII-88 had already begun the first tests of the new version of the R-1 missile, designated the R-1A.²

The modification effort to create the R-1A, led by Korolev's assistant Konstantin D. Bushuyev, was in many ways related to the work on the still-to-be-flown R-2 missile. In particular, in 1949, a series of experimental R-1 rockets was earmarked specifically to test the separation of the payload during flight. The first of these test missiles was launched into a ballistic trajectory from Kapustin Yar on May 7, 1949, equipped for the first time with a nonrecoverable nose cone container, as well as two simulated instrument packages, each with a mass of sixty-five kilograms mounted at the rear of the missile between the stabilizer fins.³ At least three more of these R-1A tests were conducted in May under Korolev's direction, essentially confirming the basic design elements of the separating payload section.

The first vehicle with actual scientific instruments was prepared for its first launch in the third week of May. The instruments designed to measure air pressure and air composition were developed at the Geophysical Institute of the Academy of Sciences (GeoFIAN) under the leadership of B. L. Dzerdzyevskiy and Ye. M. Reikhrudol. Vernov himself was involved in the test preparations. Just prior to launch, special glass containers were emptied of air, hermetically sealed, and installed in the payload packages. Following the launch of the R-1A missile and engine cutoff, a mechanism would remove the containers from their host, followed by the breaking of the glass support, enabling air to enter the containers. This would be preceded by the ejection of the complete packages from the rocket into a path ahead of the missile's trajectory so as not to collect air contaminated by the exhaust of the R-1A. Newly developed parachutes were then to bring the scientific instruments safely back to Earth.⁴ With the exception of the design of the separable payload, the R-1A was not much different from the military R-1. The vehicle was just under fifteen meters in length and had a fueled mass of 13,910 kilograms.

The very first R-1A with operational scientific packages, officially designated FIAR-1, was launched into a vertical trajectory at 0440 hours local time on May 24, 1949.⁵ The initial phases of the launch were successful, and the FIAR-1 packages were ejected without problem, having reached an altitude of about 100 kilometers. Seventeen seconds following ejection, at which point the containers had dropped twenty kilometers in free flight, the parachute deployed on schedule, but the shock of its unfurling resulted in damage to the canopy. The landing was much harder than expected, and both the containers were deformed, thus terminating any hope of scientific data. An inspection of the recovered capsules showed, however, that the instruments had operated as planned. In the ensuing days, engineers quickly designed a modified parachute system, while improving the shock-absorption capabilities of the FIAR-1 containers.

2. The report on the "new" missile was titled "Plan for the V-1A Experimental Geophysical Missile With a Separable Payload." See Biryukov, "Materials in the Biographical Chronicles," p. 227. See also Yu. P. Semenov, ed., *Raketno-Kosmicheskaya Korporatsiya "Energiya" imeni S. P. Koroleva* (Korolev RKK Energiya, named after S. P. Korolev, 1996), p. 34.

3. Biryukov, "Materials in the Biographical Chronicles," p. 228. Peter Stache, *Soviet Rockets*, Foreign Technology Division Translation, FTD-ID(RS)T-0619-88 (from unnamed source), Wright-Patterson Air Force Base, Ohio, November 29, 1988, p. 209. This is a translation of Peter Stache, *Sowjetischer Raketen* (Berlin: Militärverlag der DDR, 1987). A more recent report suggests that the first launch may have been on April 21, 1949. See G. A. Kustova, ed., *Ot pervogo Sputnika do "Energiy": "Burana" i "Mira"* (Moscow: RKK Energiya, 1994), pp. 6, 125.

4. Stache, *Soviet Rockets*, p. 209.

5. Biryukov, "Materials in the Biographical Chronicles," p. 228. "FIAR" was the Russian acronym for "Physical Research of the Atmosphere by Means of Missiles." Soviet sources have variously referred to the containers as both FIAR-1 and FIAN-1. For the latter, see, for example, M. I. Cerasimova, "Embodiment of a Dream" (English title), in M. I. Gerasimova and A. G. Ivanov, eds., *Zvezdnyi put* (Moscow: Politicheskoy Literatury, 1986), p. 18.

A second launch, the last and sixth of the R-1A type, took place on May 28.⁶ This time, the missile reached an altitude of 102 kilometers, and both containers were recovered without incident. Unfortunately for the scientists from GeoFIAN, the measuring equipment worked poorly, thus affecting the quality of information gathered.⁷ Clearly, the scientific results from the two launches were meager, but the overall outcome of the series was considered satisfactory. Korolev, summarizing the launches a few years later, recalled that:

1) We were able to experimentally show that it was possible to transport equipment for the investigation of the upper layers of the atmosphere by rocket to altitudes of 100 kilometers, to eject the equipment-filled container, and to safely bring it back to Earth; 2) it was found that devices for measurement of the high temperature operated normally during ascent, ejection, and freefall; 3) for the first time it was possible to make direct measurements of air pressure at an altitude of approximately 100 kilometers and to take air samples. Despite the modest results of these first launches and numerous serious technical and methodological deficiencies, as well as serious defects in equipment, these flights awoke the enthusiasm of all involved and awakened the interest of institutes and organizations of the USSR Academy of Sciences as well as of the industry."

The launches of the R-1A missiles were only one of numerous rockets conducted at Kapustin Yar during that period. Perhaps the most important tests at the range were those of the second series of R-1 rockets, designed to incorporate improvements following the poor performance of the first series in late 1948. The initial manufacture of the basic frames of the second group of about twenty missiles had begun as early as August–September 1948 at the NII-88 plant in Kaliningrad. The launches were carried out between September 10 and October 23, 1949, once again under Korolev's leadership. In contrast to the first series, which had raised serious doubts among military commanders on the effectiveness of the missiles, these tests were far more successful and restored confidence in the new rocketry industry. Of the total of twenty missiles launched, seventeen reached their designated sixteen- by eight-kilometer target area, while only two were complete failures.⁸ A third series of ten launches of the R-1, called the "P" series, was also apparently conducted soon after, with seven reaching the target.⁹

These launches were critical to the training of the first Soviet rocket troops, and the high number of manufactured rockets and test launches suggests an unusually important emphasis on improving the operational characteristics of the rocket as a weapon of war. The path to actual deployment in the armed forces proved to be longer than expected. It was a further year of

6. Biryukov, "Materials in the Biographical Chronicles," p. 228, M. V. Keldysh, ed., *Tuorcheskoyenaslediye akademirka Sergeya Paulouicha Koroleua izbrannyye trudy i dokumenty* (Moscow: Nauka, 1980), p. 348

7. Some of the results are compiled in B. A. Mirtov and L. A. Vedeshin, "Research of the Upper Atmosphere—First Rocket Experiments in the USSR" (English title), International Astronautical Federation, 1975. A translation of this document is available in the folder on Soviet suborbital launches, translation no. TT 76-53470 by Saad Publications, NASA History Reference Collection, NASA History Office, NASA Headquarters, Washington, DC

8. Keldysh, ed., *Tuorcheskoye nasledie akademika Sergeya Paulouicha Koroleua*, p. 349. These comments are part of Korolev's speech titled "Investigation of the Upper Atmosphere with Powerful Long-Range Missiles," given at the All-Union Conference on Missile Investigations of the Upper Atmosphere, held in April 1956, part of which is reproduced in Keldysh, ed., *Tuorcheskoye nasledie akademika Sergeya Paulouicha Koroleua*, pp. 348–61. The six launches of the R-1A were carried out on May 7, 10, 15, 17, 24, and 28, 1949.

9. Biryukov, "Materials in the Biographical Chronicles," p. 229; B. Ye. Chertok, *Rakety i lyudi* (Moscow: Mashinostroyeniye, 1994), p. 326. Another authoritative source suggests that 45 percent—that is, nine of the twenty—reached the target, which, if true, was still a vast improvement over the first series. See G. A. Sadovoy, "10 October—40 Years After the First Successful Launch of the First Soviet Guided Missile of Long Range R-1 (1948)" (English title), *Iz istorii aviatsii i kosmonavтики* 59 (1989), 94–101.

10. Sadovoy, "10 October—40 Years After."

industrial and engineering efforts before a final order was issued on November 28, 1950, formally adopting the R-1 missile as armament of the Soviet armed forces." The following month, a new division of soldiers, the 23rd Special Purpose Engineer Brigade of the Rocket Troops of the High Command, was formed at Kapustin Yar to receive the first operational batch of R-1 missiles as effective components of Soviet military power." The brigade, headed by Col. Mikhail G. Grigoryev, served as the original core of what would later become the famous USSR Strategic Missile Forces. Like many of the other artillery officers of the period, Grigoryev would go on to play a leading role in the Soviet space program as the first commander-in-chief of the Plesetsk launch site.

At the time that the R-1 was moving ahead with its own road to official deployment, Korolev was already advancing with work on his coveted R-2, which had faced such a hard road to approval. Coinciding with the second series of R-1 test launches, he was on hand at Kapustin Yar to direct the first launches of an experimental version of the R-2, designated the R-2E. The purpose was to primarily test the flight results of a separable warhead container so important for the further improvement of characteristics of Soviet ballistic missiles. With an appearance very similar to the planned R-2, the R-2E was just under seventeen meters in length, about a half a meter shorter than its ultimate successor. The first of five of these experimental missiles lifted off from Kapustin Yar on September 25, 1949, at the very same time that the second series of R-1 tests was in progress." The warhead container tests were not completely successful, due to malfunctions in the automatic stabilization system at the time of separation. These problems were traced to the use of new and advanced gyro-stabilization systems developed at NIИ-10 under Chief Designer Kuznetsov. The obstacles took a considerable time to overcome. The three successes did, however, instill sufficient confidence in Soviet capabilities to eliminate any doubt about terminating work on the German G-1 concept, with which the R-2E shared many performance characteristics.

The first full-scale launch of an R-2 took place on October 21, 1950, a full year after the R-2E tests. The attempt was a failure and prompted lengthy discussions, which ended up in conflicts between engineers responsible for the suspected malfunctioning part. Partly as a result of these discussions, Pilyugin later developed a special electronic dynamic modeling unit to simulate "steering" effects on the R-2, based directly on the work of Dr. Hoch, one of the German engineers who ironically had no knowledge of the R-2 tests at the time. The second attempt on October 26 was a partial success and deposited the payload 600 kilometers from the launch site." The initial troubles with the missile, however, continued to worry the engineers, and the test series was extended far beyond the initial planned schedule. After one of the longest series of launches in recent memory, the final R-2 finally lifted off on December 20. It was also one of the most disappointing series, quite possibly, in the history of the Soviet ballistic missile program. All twelve missiles launched failed to achieve their primary objectives: there were engine failures, guidance system malfunctions, and warhead trajectory errors.

11 I D Sergeyev ed Khronko osnovnykh *sobytyi istorii raketnykh voysk* strategicheskogonaznacheniyu (Moscow TsIPK 1994) p 34 Even after formal adoption by the armed forces further testing of the R 1 was continued at Kapustin Yar Controlled winter launches in temperatures as low as minus twenty six degrees Centigrade were carried out between January 29 and February 2 1951 A further series occurred between June 13 and 27 1951 These launches had a 100 percent success rate in reaching the assigned targets

12 Col A Belousov They Were Conceived at Kapustin Yar' (English title) Krasnaya zvezda January 3 1991 p 2

13 Biryukov "Materials in the Biographical Chronicles " p 229 Chertok Rakety i lyudi p 336 The five R 2E missiles were launched on September 25 and 30 and October 2 8 and 11 1949 Of these three were considered successes

14 Biryukov ' Materials in the Biographical Chronicles " p 230

Despite the failures, the R-2 launches contributed significantly to the expertise and knowledge of long-range ballistic missiles. It was the first minor step forward from the German origins of postwar Soviet ballistic missiles. The development of the R-2 missile also represented a marked level of maturation of the Soviet rocket-building industry. The effort to produce a replica of the A-4, in the late 1940s, finally paid off in a swifter and more efficient exchange of information between engineers and production managers. At least twenty-four scientific research institutes and ninety industrial enterprises coordinated their efforts to produce the vehicle."

With such an intensive series of launches at Kapustin Yar, the range remained continually busy as hundreds of engineers, military officers, and secret police officials traveled to and from the site, all dealing with the major climactic hazards at GTsP-4. The winter of 1950 was particularly harsh as at least two meters of snow was deposited on the launch site. The following spring, personnel discovered the thawed body of a soldier who had been frozen to death. Searchers also found a herd of horses who had met the same fate. For the most part, sleeping quarters remained either tents or trucks: the concrete buildings were still in the process of construction.¹⁵ Roads were almost nonexistent at the time, while mail was intermittent at best. Recollections of the time all describe the area as one of the toughest and demanding for those involved. For the mostly military personnel who were stationed there permanently, the majority of whom had survived the turmoil of World War II, it was another excursion into incredible hardship.

The R-3 Missile

The R-1 and R-2 missiles served as the beginning point for Soviet postwar ballistic missile programs. Given the ultimate military needs of the Stalin leadership, both were, however, woefully inadequate. The need for a "transatlantic" missile had been formally tabled as early as 1947, at a Kremlin meeting attended by Stalin and then chair of the Special Committee No. 2, Georgiy M. Malenkov. The latter was one of those who argued vociferously in favor of such missiles, and according to one recollection, "no limits were to be placed on available funding." At the time, the focus was clearly divided between winged missiles, such as the Sanger-Bredt bomber, and traditional ballistic missiles, which were developed at the NII-88. As a starting point to fulfill Stalin's request, in late 1947, Korolev had begun low-level studies to produce a ballistic missile with a range of 3,000 kilometers, over ten times more than the German A-4. Even the resident Germans at Kaliningrad and Gorodomlya were concerned with the relatively modest G-1 with its range of 600 kilometers. The concept was evidently discussed at high levels within the Soviet government, for on April 14, 1948, the USSR Council of Ministers issued a decree sanctioning exploratory work on such a missile, designated the R-3 or "product 8A67."¹⁶ Over the following year and a half, a group of Korolev's engineers slowly established the design specifications of the missile and incorporated them into a twenty-volume technical document called a draft plan, co-authored by Korolev and completed in June 1949." The other principal authors were Korolev's first deputy Mishin and engineers Bushuyev, Kryukov, Okhupkin, and Svyatoslav S. Lavrov, a ballistics expert.

15. Yaroslav Golovanov. *Korolev fakty i mry* (Moscow: Nauka, 1994), p. 420.

16. Col M. Rebrov. "Where the Cranes Fly" (English title). *Krasnaya zvezda*, September 19, 1987, pp. 3-4; Belousov. "They Were Conceived at Kapustin Yar"; Yu. A. Mozzhorin, et al., eds., *Dorogi v kosmos I* (Moscow: MAI, 1992), p. 94.

17. Yu. A. Mozzhorin, et al., eds. *Nachalo kosmicheskoy ery vospominaniya veteranov raketno-kosmicheskoy tekhniki i kosmonavtiki uypusk uoroy* (Moscow: RNITsKD, 1994), p. 71.

18. Semenov, ed.. *Raketno-Kosmicheskaya Korporatsiya*, p. 629.

19. Biryukov, "Materials in the Biographical Chronicles," p. 227. A. Yu. Ishlinskiy, ed.. *Akademik S P Korolev: ucheniy, inzhener, chelouek* (Moscow: Nauka, 1986), p. 300; Chertok. *Rakety i lyudi*, pp. 219-20.

Unlike draft plans for other missiles, Korolev structured this particular work in such a way that it would serve as a reference work for future efforts in the design of long-range missiles. The first volume, titled "Principles and Methods of Designing a Missile of Great Range," was a 282-page type-written document that was a detailed theoretical treatise on missile design that went far beyond the modest German-derived R-1 and R-2 missiles.²⁰ While focusing loosely on the new R-3, it was also in essence a "how-to manual" for very long-range missiles—that is, a solid reference work for future efforts that would eventually lead to the creation of the first Soviet ICBM. The report examined six specific areas of investigation:

- Research on flight characteristics of three variants of single and multistage long-range ballistic missiles
- Preliminary research on flight characteristics of winged (or cruise) missiles with various types of separable winged warheads
- Research into the principles of separable warheads for long-range missiles
- Research on standard cruise missiles with separable winged warheads both with and without sustainer rocket engines
- Preliminary research on the aerodynamic characteristics of cruise missiles
- The problems of dynamic flight of long-range cruise missiles"

A major portion of the study was clearly focused on cruise missile concepts, perhaps indicative of Korolev's personal vision of rocketry, which for most of his life had been connected to winged rather than ballistic missiles. Stalin's own interest in cruise missiles may have also played a factor in the relative emphasis of the two competing roads, as evidenced by his continuing support for the Sanger-Bredt concept.

In terms of the future of Soviet rocketry, it was the portion dedicated to the ballistic missile that had the most relevance. In examining the possible ballistic configurations, Korolev advanced three possible ballistic "composite" (BS) or multistage schemes for the next generation of Soviet missiles:

- BS no. 1 envisioned a classic multistage vehicle with several stages connected together in tandem, each stage falling off as its propellant was exhausted.
- BS no. 2 examined the use of exterior fuel tanks, which would serve the engine on the core stage and be jettisoned following propellant depletion.
- BS no. 3, harking back to Tsiolkovskiy's theories, used a parallel arrangement of all the stages, all firing at liftoff, followed by discarding the strap-ons, after which the core would continue to fire as the "second stage."

Although the study was focused primarily on the creation of a 3,000-kilometer range missile, throughout the document at key points, Korolev mentioned the possibility of designing an even more powerful rocket with an intercontinental range. In his introduction, he stated:

²⁰ An edited version of this first volume has been published in Keldysh, ed., *Tuorcheskoye naslediyе akademika Sergeya Pavlovicha Koroleva*, pp. 291–318. Korolev himself co-authored volumes I, II, IV, V, VI, and XIV. See p. 396.

²¹ Ibid., pp. 291–92.

²² Ibid., pp. 298–99.

A range equal to 3,000 km can be viewed only as the first stage that makes it possible to solve certain problems envisaged in the requirement for the R-3. The costs and the whole complex of technical measures necessary for attaining the range of 3,000 km are so great that it would be unacceptable to isolate this work from the prospects of further development. Therefore, for the following stage, for solving significantly greater tasks, a range on the order of 8,000 km was projected with an increased payload."

In looking at future intercontinental range missiles, Korolev argued that the "most prospective choice" was the cluster concept of BS no. 3, a decision that was to a great degree based on his friend Tikhonravov's studies on a satellite launch vehicle at NII-4. Tikhonravov's work in 1947-48 clearly pointed in the direction of what he called the "packet" scheme, a euphemism for using clusters of stages linked together in a parallel arrangement at liftoff. For many of the same reasons that Tikhonravov had rejected a successive-staged vehicle for the present time, Korolev himself had begun to accept that a packet scheme would allow for an easier creation of an ICBM. In conducting his studies, Korolev had also studied the German A-9/A-10 concept proposed initially at Peenemünde during the war. That design used the A-10 rocket as a first stage, which would boost the A-9 second stage, essentially a modified A-4, into an intercontinental trajectory. The range was about 5,200 kilometers.²⁴ Tikhonravov's original recommendations for using a packet scheme precluded any serious work on the German plan.

Assessing the level of Soviet technology, and in particular the envelope of high-thrust engine development, Korolev settled on a standard single-stage ballistic design scheme for the R-3, its classic cylindrical shape a distinct step away from the German A-4. On December 7, 1949, Korolev formally presented the R-3 draft plan at a meeting of the Scientific-Technical Council of NII-88. A specially established council of experts enthusiastically approved the full-scale development of the missile, emphasizing the "extraordinary" scale of the effort."

The R-3 program was without doubt the largest and most expensive ballistic missile effort in the Soviet Union to date. The lead organization for the missile's design was Department No. 3 of NII-88's Specialized Design Bureau under Korolev. For the first time, there was significant cooperation with other organizations, including the Department of Applied Mathematics in the V. A. Steklov Mathematics Institute of the USSR Academy of Sciences. Led by the ubiquitous Keldysh, this small department had been established in 1944, and in 1948, it began serious scientific research into such areas as rocket dynamics and applied celestial mechanics."

There were two primary design features of the R-3 that represented deviations from A-4-derived Soviet ballistic missiles, such as the R-1 and R-2. To reduce the lifting mass of postwar rockets, Korolev had partially incorporated the concept of load-bearing tanks into the R-2 missile, a configuration that allowed the propellant tanks themselves to serve as the main frame of the missile. On the R-2, only one tank, the one carrying ethyl alcohol was load bearing. With the R-3, engineers worked to develop a new missile in which *both* propellant tanks were load bearing. Second, engineers dispensed with the heavy and large stabilizing fins made

²³ Ibid. p. 292. See also David Holloway *Stalin and the Bomb: The Soviet Union and Atomic Energy 1939-1956* (New Haven, CT: Yale University Press, 1994) p. 249 for a similar English translation of the same passage.

²⁴ Frederick I. Ordway III and Michael R. Sharpe, *The Rocket Team* (New York: Thomas Y. Crowell, 1979) pp. 56-57.

²⁵ The expert panel included A. A. Kosmodemianskiy (Special Committee No. 2), A. I. Makarevskiy (TsAGI), Yu. A. Pobedonostsev (NII-88), Kh. A. Rakhmatulin (MVTU), and M. K. Tikhonravov (NII-4). See also Semenov, ed., *Raketno-Kosmicheskaya Korporatsiya*, p. 40; Biryukov, "Materials in the Biographical Chronicles," p. 229; Chertok, *Rakety i lyudi*, p. 220.

²⁶ V. S. Avduyevskiy and T. M. Eneyev, eds., *M. V. Keldysh: izbrannyye trudy raketnaya i kosmonavtika* (Moscow: Nauka, 1988) p. 7.

of graphite, which were a standard on the R-1 and R-2 vehicles and significantly reduced lifting capacity." The fins were retained on the R-2 so as not to introduce too many changes into the original A-4 design, but during flight testing, they were responsible for unnecessary aerodynamic resistance and stress on the missile.

Technically speaking, there was a direct connection of lineage from the experimental R-2E missile to the new R-3 model. The R-2E had tested some new design features that would end up in the R-3, in particular the integral fuel tank and the separating warhead. These technical innovations had been largely responsible for the twofold increase in range of the R-2E over the R-1 missile. For the R-3, Korolev's engineers would need to make more departures from the German antecedents of postwar Soviet rocketry. Perhaps the most risky proposition of the whole venture was the design of the main engine for the rocket. Korolev's engineers switched from the tried and tested liquid oxygen-alcohol combination so preferred by the von Braun team to the more efficient liquid oxygen-kerosene pairing, which allowed an increase in specific impulse of about 20 percent. To reduce the risk of failure, NII-88 contracted two different engine design teams to create the main 120-ton thrust engine for the R-3. These were Glushko's OKB-456 based at Khimki and a department at NII-1 under Chief Designer Aleksandr P. Polyarniy, an old prewar associate of Korolev's from GIRD.²⁷ Each group was to offer its own competitive design. In a direct link to the Soviet version of the Sanger-Bredt bomber, both these engines were also earmarked for use on the latter vehicle, a decision that no doubt reduced significant duplication of work.

The Glushko engine, designated the RD-110, was the very first high-thrust liquid oxygen engine to be designed under his direction during his twenty-year career. Traditionally, Glushko had been reluctant to use liquid oxygen because of technical obstacles related to vibration, and preferred nitrogen-based oxidizers. In his initial conception of the new engine, Glushko, unlike Korolev, did not choose to adopt any radically new design approach. Instead, he used the old A-4 engine combustion chamber and scaled it up to match the required performance characteristics needed for the R-3. Polyarniy evidently preferred to use an alternative approach for his D-2 engine, also with 120 tons of thrust.

In looking at future variants of long-range missiles, Korolev's engineers had proposed the use of multistage rockets, but for the R-3's range of 3,000 kilometers, they believed that a single-stage missile would have significant advantages in mass and other parameters over a multistage one. The R-3 design included the use of a separable warhead and a new aluminum-magnesium alloy as the main structural material. The propellant tanks would be pressurized with liquid gas vapor rather than compressed air, as had been the practice before. Engineers improved the missile's mass efficiency by compacting its configuration as much as possible. They eliminated intertank structures with instrument sections and instead placed control and service devices in previously unoccupied spaces at the rear section of the rocket. In addition, bolted joints were replaced by welded ones, and the engine's proportional length was reduced by increasing combustion chamber pressure and adopting a contoured nozzle." These were all significant innovations in the Soviet rocketry industry that in some cases served to give birth to new manufacturing technologies that would become common practice in the early Soviet space program

27 Mozzhorin et al eds *Nachalo kosmicheskoy ery* p 261 Yu Biryukov and A A Yermenko "50 Years for the Native Rocket Space Industry The Early Period of Development" (English title) *Novosti kosmonautiki* 10 (May 6-19 1996) 54-64

28 J V Biriukov "The R 3 Rocket Project Developed in the U S S R in 1947-1959 as a Basis for the First Soviet Space Launchers" in J D Hunley ed *History of Rocketry and Astronautics* Vol 19 (San Diego CA Univelt 1997) pp 193-99

29 Biriukov "The R 3 Rocket Project Developed in the U S S R "

STALIN AND THE ROCKET

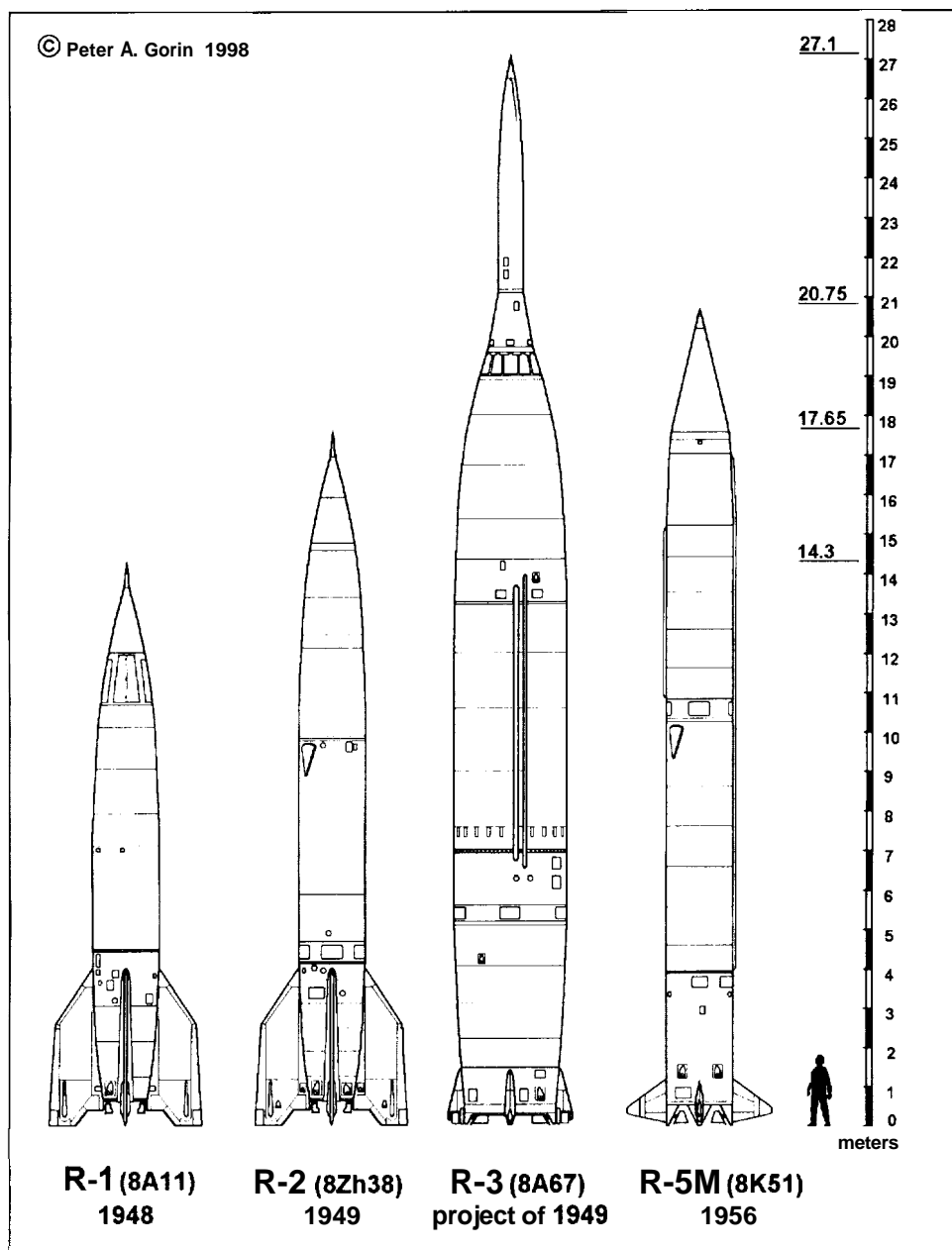

Soviet ballistic missile development between 1946 and 1956. The R-3 missile was a significant leap in capabilities from the German antecedents of the Soviet ballistic missile program. Incorporating many new technical innovations, the R-3 would have a range of 3,000 kilometers—ten times more than the German A-4. The missile was approved for development in December 1949. (copyright Peter Gorin)

As with the engines. Korolev initially contracted the development of the R-3's guidance system to two competitive groups. A traditional autonomous system would be developed by NII-885 under Chief Designers Ryazanskiy and Pilyugin, both of whom had worked on the R-1 and R-2. A second team, under an ambitious and talented guidance specialist named Boris M. Konoplev at NII-20 (for radio systems) and A. I. Charin at NII-49 (for gyroscope units), was invited to participate for the first time in the ballistic missile program."

The guidance system for the R-3 missile was selected using the extensive experience from the German designs on the A-4 and the successor Soviet modifications on the R-1 and R-2 vehicles. The results of the A-4 flight test program had, in particular, allowed the testing of several different guidance systems, including an autonomous system developed by Chief Designer Pilyugin, a German system for lateral radio control designated Hawaii-Viktoria, improved by Deputy Chief Designer Mikhail I. Borisenko, and a second German telemetry system called Messina-I, reproduced by the Soviets under Deputy Chief Designer Yevgeniy Ya. Boguslavskiy. All three individuals were prominent members of NII-885, the leading missile guidance organization in the Soviet Union at the time. The tests with the A-4 and the R-1 had also, however, showed some limitations. Given the need to achieve increased accuracy in a very short time period, it had become clear to some engineers that autonomous guidance and control systems did not offer a quick solution. With this in mind, Korolev turned to the short-term solution of using active guidance by remote control from the ground—that is, a purely radio-controlled guidance system. The Germans had already conducted research in this area (on the Hawaii-Viktoria system), and Chief Designer Konoplev at NII-20 was contracted to develop a new radio-controlled system for the R-3 designated Topaz." The Topaz project using "variable system architecture" was important for the Soviet missile industry in general because it established the groundwork for a new engineering discipline called radio ballistics. The decision to use the Topaz design was also significant for it was opposed by Chief Designer Pilyugin who by then had not only become Korolev's most important associate on guidance issues, but who was also firmly in favor of an autonomous system for the R-3.

The R-3 missile, as envisioned in the December 1949 plan, was a single-stage rocket that was just over twenty-seven meters long with a base diameter just under three meters and made of a new aluminum-magnesium alloy. The total fueled launch mass was seventy-one tons, while sea-level launch thrust was about 120 tons. The vehicle was designed to lob a three-ton separable warhead a distance of 3,000 kilometers." Launches would be conducted from mobile platforms, much like those of the R-1 and the R-2. Given its proposed range, the R-3 would be the first Soviet ballistic missile capable of reaching Great Britain and Japan, giving the Soviets their first true strategic missile. A stunning qualitative and quantitative leap over any previous missile in the Soviet Union, the new rocket project was a watershed milestone in the development of Soviet rocketry. To give some indication of Korolev's ambition, it may be instructive to note that in 1949, the Soviet copy of the German A-4 had yet to be declared operational by the Soviet armed forces, while the R-3 had a flight range ten times more than that missile.

Because the R-3 represented such a leap in capabilities for the new Soviet rocketry industry, the Scientific-Technical Council of NII-88 recommended that some of the new technologies adopted for the R-3 be tested on a smaller experimental rocket known as the R-3A. The latter rocket, based in design on the much smaller R-2, used an integral oxygen tank as well as a finless rear section. Models of the experimental missile would also be used to prove out such innovations as high boiling oxidizers, high calorific fuel, and test technologies earmarked for future

30. Chertok, *Rakety i lyudi*, p. 220.

31. Mozzhorin, *et al.*, eds., *Nachalo kosmicheskoy ery*, p. 278–80.

32. Stache, *Soviet Rockets*, p. 179; Sernenov, ed., *Raketno-Kosmicheskaya Korporatsiya*, p. 40.

rockets such as strap-on boosters and winged warheads. With the two basic improvements—that is, the integral tank and the omission of the rear rudders—the R-3A displayed significantly improved flight characteristics over its antecedent, the R-2. The missile had a mass of almost twenty-three and a half tons and main engine thrust of forty tons—values comparable to the R-2—but a range that was one and a half times more than the R-2, about 935 kilometers." Flight testing of the R-3A was planned for 1951, with launches of the R-3 commencing in 1952 or 1953 at the earliest.

At about the same time that work on the R-3 was emerging as the primary thematic goal of Korolev's team, Academician Keldysh's team was winding down work on the Sanger-Bredt antipodal bomber. Since research on the program had begun in 1946, a variety of technical obstacles had plagued engineers. In 1948, Keldysh's NII-1 was institutionally subordinated to the Central Institute of Aviation Motor Building (TsiAM), one of the most prestigious Soviet scientific institutions, which focused research on aeronautical propulsion. As head of the TsiAM section on ramjet engines, Keldysh continued to work on the Sanger-Bredt project, but by 1950, technological complexities, in particular with the propulsion systems, seem to have overwhelmed any attempt at a full-scale project. Keldysh instead redirected some of the team's work in December 1950 to a more modest automated intercontinental cruise missile—one that would use tried and tested technologies. He wrote in his report on the new conception that research had "confirmed the possibility and advisability of using in the capacity of launch accelerators. [RD-100] engines from long-range missiles of the R-1 type."³⁴ The vehicle could use the same launch facilities as those for the R-1. After initial launch by these engines, flight at altitude would be handled by a set of supersonic ramjet engines. The aircraft-cum-missile would be able to carry a three-ton warhead a distance of 6,000 to 7,000 kilometers, flying most of the way at an altitude of fifteen to twenty-five kilometers at speeds of 3,000 to 3,500 kilometers per hour.

It seems that TsiAM was conducting extensive research during this period on the development of ramjet engines for use on such intercontinental designs. Between 1947 and 1950, efforts at the institute encompassed work on a supersonic "diffuser," which was tested at the institute at velocities of up to Mach 4. In addition, scientists built and tested an experimental combustion chamber for the ramjet engine at speeds reaching Mach 2.6. Such a motor, with a thrust of almost twenty-one tons, was also successfully tested at the institute simulating flight at an altitude of 8,000 meters. Georgiy I. Petrov, a brilliant scientist in his late thirties under the employ of Keldysh led most of these early groundbreaking studies. Awarded the USSR State Prize for his work on diffusers in 1949, two years later, Petrov was personally responsible for the design of the first Soviet aerodynamic wind tunnel capable of testing speeds of up to Mach 10.³⁵ The work on ramjet engines was not without problems. Although Soviet scientists had a long history of ramjet development beginning the 1930s, the leap to supersonic speeds proved to be a very difficult transition. In a document from November 1951, Keldysh lists a litany of technical obstacles that had plagued the supersonic ramjet program during 1948–51, including the inability to model the working processes of such engines on the ground and the problems in creating stabilization systems for combustion chambers."

33. Semenov, ed., *Raketno-Kosmicheskaya Korporatsiya*, p. 40; Biryukov and Yeremenko, "50 Years for the Native Rocket-Space Industry."

34. Keldysh's document, dated December 11, 1950, is reproduced in full as M. V. Keldysh, "On the Composition of Work on PVRDs and Their Applications" (English title), in Avduyevskiy and Eneyev, eds., M. V. Keldysh, p. 35–38.

35. M. V. Keldysh, "On the Scientific Activities of G. I. Petrov" (English title), in *ibid.*, pp. 140–42. The document is dated September 21, 1952.

36. M. V. Keldysh, "On the Development of Work on Research on PVRDs in Flight" (English title), in *ibid.*, pp. 38–39. The document is dated November 4, 1951.

The work on the Sanger-Bredt antipodal bomber in 1946 and 1950, and the subsequent research on ramjet engines and high-speed aerodynamics, had a profound impact on the future thematic direction of the Soviet efforts to develop a transatlantic missile. The 1947 directive to develop such a vehicle led to two different but parallel options: a ballistic missile that would travel above the atmosphere for part of its trajectory and a winged cruise missile that would fly within the atmosphere during its entire flight. There was a considerable amount of emphasis on both fronts, and confidence in one road was often inversely proportional to the level of difficulties faced in the alternate path. By the turn of the decade, with the advent of the R-3, the overseers of the Soviet missile program, the omnipotent Special Committee No. 2, seem to have been favoring the ballistic missile option. Difficulties with the development of ramjet engines no doubt contributed to such a climate. At the same time, the ballistic R-3 was itself a risky endeavor. Looking to reduce risk, the Special Committee was unable to firmly decide in favor of one particular approach for an intercontinental delivery system. For almost another decade, engineers and policy makers would continue to debate over the propitiousness of one option over the other.

The End of the Road for the Germans

The abortive G-1 missile effort did not instill much hope for the Germans at Gorodomlya. As far as they were concerned, the months of intensive effort on the project effectively turned out to be a waste of time when the program was terminated in 1949. By then, almost all the Germans had been transferred to NII-88's Branch No. 1 at Gorodomlya in Lake Seliger, where the living conditions continued to be a major obstacle to fruitful engineering work. More than two years after the formation of the branch, the Germans were still, for the most part, living in huts, with no effective sewage or sanitation systems. Morale was a serious problem among the group, compounded by bitter infighting among the Germans and problems of alcoholism and marital infidelity.³⁷ Only on rare occasions were they allowed to leave the island to visit Moscow. Under these conditions, the group worked on a series of successor missile projects to the G-1, all of which were viewed very favorably by Crottrup's men as ways to divert their attentions from their more earthly problems. This work was performed on request by their Soviet bosses: at no point were the Germans informed of the ultimate fate of their efforts.

The winding down of work on the G-1 was followed by work on the more capable G-2 (or R-12) missile. In 1948-49, a preliminary draft plan for the vehicle was developed that envisioned the use of a missile with a range of 2,500 kilometers—far in excess of the G-1 and in fact much closer to the Soviet R-3. The Germans designed a booster that incorporated a variation of the so-called cluster scheme, in which three engines would fire at liftoff and two of the engines would be jettisoned. A similar one-and-a-half-stage configuration was used many years later in the U.S. Atlas ICBM. The total launch thrust of the missile was 100 tons, achieved by using engines from the abandoned G-1 missile. Some of the design elements incorporated into the vehicle elicited much interest from the Soviet side. For example, the G-2 was the first post-A-4 missile that rejected the traditional use of gas vanes to steer the rocket. Such a concept was still a novelty for Korolev's engineers, and the Soviets themselves would not in fact completely dispense with the concept until development of their first ICBM in the mid-1950s. Furthermore, the Germans introduced a means of regulating total thrust by using a peripheral group of three engines at the base of the rocket 120 degrees apart. A similar concept would later be used in the Soviet N1 lunar booster in the 1960s.³⁸ Despite its technical advancements, work on the G-2 was shut down in 1949.

37 Ordway and Sharpe *The Rocket Team* pp 336-340

38 *Cherokh Rakety i lyudi* pp 218-19. CIA Office of Scientific Intelligence. "Scientific Research Institute and Experimental Factory 88 for Guided Missile Development, Moskva/Kaliningrad." OSI C RA/60-2 March 4, 1960 pp 7-8

A third project during the same period served to marginally raise the spirits of the Germans. On April 4, 1949, Minister of Armaments Ustinov personally visited the Gorodomlya facility with a proposal to the Germans to design a missile that could carry a three-ton warhead a distance of 3,000 kilometers." The specifications were identical to those for the Soviet R-3 missile, and Ustinov's proposal was quite likely a means to augment the R-3 effort by absorbing as many technical innovations as possible from all sources. This new German missile project, called the G-4 (or R-14), reinvigorated the energies of Grottrup's team, which was given only three months to complete a preliminary draft plan on the missile. Given the circumstances, what they came up with was no less than astounding.

The G-4 was a single-stage, cone-shaped, twenty-five-meter-long vehicle with a single 100-ton-thrust engine. The Germans completely dispensed with fins and aerodynamic control surfaces and also incorporated a full monocoque structure, much like the Soviets did with the R-3. Perhaps the major difference with the R-3 was the G-4's use of the traditional combination of liquid oxygen and alcohol—a combination that the Germans, both in the Soviet Union and the United States had favored over other mixtures. The main engine would have its combustion chamber cooled by circulating alcohol through its walls, while the turbopumps for the propellants would be driven by hot gases "bootstrapped" from the combustion chamber of the main engine. For roll control, the Germans introduced the idea of using exhaust gases from the turbopumps diverted through a nozzle that could be swiveled. A similar scheme was in fact used in the 1950s on the U.S. Jupiter missile by von Braun's team. As was standard in all post-A-4 missiles, the warhead was to fly separately from the main body of the missile after a certain point in the trajectory. One of the most impressive elements of the G-4 design was the plan for a massive underground factory, designed by Heinz Jaffke and Anton Narr, from which the missiles could be built and launched. Systems were designed that could also extract oxygen from the air to manufacture liquid oxygen.

On October 1, 1949, Ustinov sent NII-88 Director Maj. General Gonor, Chief Engineer Pobedonostsev, and Chief Designer Korolev to Gorodomlya to be briefed on the G-4 missile. It was a rare interaction between the latter and the Germans, and it was probably Korolev's last visit to the island. The Soviets returned to Kaliningrad with the product of the German team's work: the Germans themselves were given no explanation and heard little about the project ever again. Some minor redesign effort on the G-4 was continued until February 1950, but by that time, a formal decision on the R-3 had already been taken by NII-88, and presumably the Soviets saw little use in having the Germans continue with their parallel project. It was another case of German expertise compromised by a variety of factors, including perhaps most importantly an unwillingness to properly make use of their contributions.

Several more abortive projects came the way of the Gorodomlya group during the same period. The G-1M (or R-13) in the summer of 1949 involved a 1,100-kilometer-range missile using the same frame as the G-1 but with improved A-type engines. The G-5 (or R-15) effort led by Werner Albring was essentially a winged competitor to the ballistic G-4, at a time when the Soviets themselves were involved in intense debate over the utility of winged versus ballistic configurations. A final project, designated the G-3, with an intercontinental range of 8,000 to 10,000 kilometers and a payload of three to five tons, was also studied in 1949 and

1950, but details are still lacking. All these later projects were limited to their initial design, comprising only diagrams and main parameter calculations.⁴⁰

Work on the G-4 and G-5 projects coincided with a marked decrease in work among the Germans. In April 1950, the Ministry of Armaments formally decided to terminate further work on long-range missiles at Branch No. 1 at Gorodomlya. Also, by order of the ministry, on March 29 of that year, all access to classified materials was denied to the Germans." Despite the order, the Soviets continued to ask advice on technical matters well into 1951, by which time Grottrup had been replaced as technical leader of the Germans by Johannes Hoch, who died soon after from appendicitis. Despite the poor living conditions at Gorodomlya, the NII-88 leadership operated a well-maintained set of technical facilities at the island that were regularly used by the Soviets. In early 1951, groups of young Soviet engineers migrated to Gorodomlya ostensibly to be taught by the experienced Germans at these excellent facilities." It was the last time that the Soviets would make active use of German expertise in the postwar years. By this time, the Germans were spending most of their time playing sports, gardening, or reading available technical monographs to pass the time.

Already by August 1950, the Soviet government had decided to begin the repatriation of the Germans back to the German Democratic Republic. The group of several hundred departed Gorodomlya to return to their homeland in three waves, beginning in December 1951 and June 1952. The last remaining eight German scientists, including Grottrup, were given permission to leave the Soviet Union on November 22, 1953. Within a week, they were all gone, ending the seven-year existence of NII-88's Branch No. 1. The few who remained were moved back to Moscow under a Dr. Faulstich, and they were provided good salaries and five-year-long contracts in industries unrelated to missile development.

The fate of the Germans after their residency in the Soviet Union was varied. Grottrup returned at first to East Germany and then eventually to West Germany. Extensively interrogated by U.S. intelligence services in Hamburg, he was offered a chance to move to the United States to work on the Army's ballistic missile program. His wife Irrngard, however, refused to ever leave Germany again, and U.S. authorities were reportedly not very pleased with the decision. Grottrup remained in Germany until his death from cancer in 1980, while his wife authored a revealing memoir of their time at Kaliningrad and Gorodomlya.⁴³ Dr. Waldemar

40 P Bork and C A Sadovoj "On the History of Rocketry Developed in the U S S R in the First Years After the Second World War (The Participation of German Specialists in the Development of Soviet Missile Technology in the Early Post War Period) " in J D Hunley ed *History of Rocketry and Astronautics* Vol 19 (San Diego Univelt 1997) pp 143-52 Chertok *Rakety i lyudi* p 219 The G-5 essentially a smaller automated version of the Sanger-Bredt antipodal bomber was to constitute a G-1 vehicle as the first stage which would accelerate a small bomber with a wingspan of just over five meters using ramjet engines to thirteen kilometers altitude before diving down on its target The G-5 plans were also submitted to the Scientific Technical Council of NII 88 in December 1950 following which the Germans heard little from the Soviets In 1951-52 Joachim Umpfenbach one of the leaders of the German group was assigned some tasks that may have been related to the G-5 cruise missile but these were isolated jobs that did little to raise the morale of the personnel at Branch No. 1

41 CIA Office of Scientific Intelligence "Scientific Research Institute " p 5 Russian sources claim that this happened in October 1950 See also Bork and Sadovoj "On the History of Rocketry Developed in the U S S R " Chertok *Rakety i lyudi* p 221 The Council of Ministers issued a decree (no. 3456-1446) on August 13, 1950 on the fate of German rocketry specialists in the Soviet Union that called for their repatriation See V F Rakhmanin and L Ye Sterpin eds *Odnazhdy i navsegda dokumenty i lyudi o sozdatel'nykh raketnykh dvigateley i kosmicheskikh sistem akademikye Valentinyye Petrovichye Glushko* (Moscow Mashinostroyeniye 1998) p 447

42 Ordway and Sharpe *The Rocket Team* p 341

43 Peter Smolders "I Meet the Man Who Brought the V-2 to Russia " *Spaceflight* 37 (July 1995) 218-20 For Mrs Grottrup's book see Irrngard Grottrup *Rocket Wife* (London Andre Deutsch 1969) Another personal memoir by gyroscope specialist Kurt Magnus has also been published See Kurt Magnus *Raketenskauen* (Stuttgart Deutschen Verlags Anstalt 1993)

Wolf, one of the few who remained behind in the Soviet Union after 1953, lived in Moscow for many years before also returning to Germany. In his remaining years in the Soviet Union, he had no contact with the ballistic missile program.

The almost eight years of involvement of the German scientists in the Soviet rocketry program clearly proved to be an essential catalyst to its further advancement. During the existence of the USSR, Soviet historians rarely, if ever, mentioned the use of German expertise in the post-war years, but the collaboration was real and extremely pivotal in furthering Soviet goals. German expertise was invaluable in 1945 and 1946 in setting up and restoring A-4 production in the Soviet Union in the form of the R-1. Without the help of the Germans, the Soviets—and in particular NII-88—would have clearly lagged in their efforts, and it might even be argued that the twelve years from 1945 to the launch of the first Soviet artificial satellite would have been far longer. This is not to take away from the intrinsic talents and dedication of the Soviet Union's own scientists. In fact, a similar argument might be made for the launch of the American Explorer I in 1958. For the Soviets, their missile programs were in a state of total disarray by the end of World War II. Decimated by the Purges and then World War II, Soviet achievements in missile building paled in comparison to the products of the Peenemünde group. Grottrup's team was indispensable in quickly transferring the database of German achievements to the Soviets, thus providing a strong foundation from which to proceed. Even in more specific areas, the Germans were instrumental in reducing the amount of time needed to attain an A-4 capability. For example, Grottrup was responsible for building the mobile launch trains for the A-4s, while Heinz Jaffke helped set up NII-88's Branch No. 2 testing stands at Zagorsk.

There are, however, key differences in the role of Germans in the United States versus that of those in the Soviet Union. The Germans in the Soviet Union never participated in the mainstream rocketry program. In fact, after the restoration of A-4 production and the G-1 debacle, they worked completely independently and without much influence on Soviet plans. Not a single one of the German missiles designed in 1947 through 1950 was ever built. Following the significant events of 1946–47, the Germans essentially played a peripheral role, proposing a number of important technical innovations, only some of which were adopted by the Soviets. Compounding Korolev's personal resistance toward cooperation with the Germans was a much more imposing political imperative—one that was grounded in xenophobia and distrust. While some Soviet engineers may have realized the extremely important value of potential German contributions to the rocketry program, there was never any concerted effort to make maximum use of Grottrup's team.

Western historians have debated much on the role of the "German factor" in the postwar development of ballistic missiles in the Soviet Union. The most common interpretation has been one very generous to the Germans—that is, that they had a significant influence over early Soviet developments. One author, writing in 1995, argued:

For years Soviet space leaders put down the contribution that captured Germans and their V-2 technology made to the Soviet ballistic missile and space programs. "Not significant," they would say. "we got mostly the technicians. The Americans got von Braun and his top team. We sent our Germans back after a few years." That explanation is no longer the Party line. In fact, it is now acknowledged that German rocket technology was bedrock to the USSR, just as it was to the US.⁴⁴

44. James Harford, "What the Russians Learned from German V-2 Technology," presented at the 46th International Astronautical Congress, Oslo, Norway, October 2–6, 1995. See also James Harford, *Korolev. How One Man Masterminded the Soviet Drive to Beat America to the Moon* (New York: John Wiley & Sons, 1997), p. 64

Such an argument conflates two clearly distinct issues: the use of recovered German technology and the use of the actual German scientists. There is no doubt that the Soviet Union benefited from A-4 technology in developing its early ballistic missiles. There is compelling reason to believe that the USSR might have floundered for years before moving ahead to such ambitious concepts as the R-3 had it not been for mastering the design and manufacturing technologies of the A-4 rocket. On the other hand, the available evidence suggests that Korolev and his team made very little use of German *expertise*, at least after 1947. Their influence over the direction of the Soviet ballistic missile program was marginal at best. Thus, if the parameters of the debate are limited to "the Germans," their contribution to the rocketry program in the Soviet Union was far less than that in the United States. In purely technical terms, the gains to the Soviets were in such areas as the design of guidance systems and the test and launch equipment. Perhaps some of the more advanced managerial techniques among the Germans may also have found their ways into Soviet institutions. A CIA report, authored in 1960 and declassified in 1980, summed up the total German contribution:

The German scientists made a very valuable contribution to the Soviet missile program[:] however, it cannot be said that without the Germans the Soviet Union would have had no significant missile program. . . . There is no doubt that it took the German wartime success with guided missiles to cause Stalin and his colleagues to devote large scale support to the Soviet effort in this field. Once this support was forthcoming the use of German scientists permitted the Soviets to achieve results in a much shorter time than it would have taken them along but there is no reason to believe that the Soviets could not have eventually done the job by themselves.⁴⁵

Satellites

One of the consistent themes running through most commentaries of Korolev's first years as a chief designer is an undeterred interest in space exploration. In the minds of most engineers in the rocketry sector, these dreams were tolerated as one of the many idiosyncrasies of his character. At the time he first became acquainted with the Germans in 1945, when the Soviets had no long-range ballistic missiles, let alone intercontinental rockets, Korolev tried to stimulate work by telling the Germans about working together to reach the Moon. Such ideas were clearly anomalies and were not shared by most of the other leading designers. There were, in fact, many in the government who suspected that Korolev's "real" objective was space travel, and the development of weaponry for the Soviet defense forces was merely a "Trojan horse" for his intentions. Given the paranoia and terror inflicted by the Soviet secret police at that time, Korolev was insightful enough to keep his hopes and plans to himself or his closest friends.

Mikhail K. Tikhonravov, at work at the Academy of Artillery Science's NII-4 organization, may have been one of the few prominent engineers who shared Korolev's vision. With a reputation for indefatigable curiosity, Tikhonravov was an unusually talented man. In his free time, he painted oil landscapes, collected wood-eating beetles, and even studied the characteristics of insects in flight, hoping to extract some insight into the dynamics of flying.⁴⁶ Interested for a long time in ascertaining the feasibility of launching an artificial satellite, the first steps in that direction had been taken in 1947, when he had initiated studies on possible configurations for a powerful multistage ballistic missile capable of reaching orbital velocity. For reasons still not

45 CIA Office of Scientific Intelligence "Scientific Research Institute" pp 10-11

46 Yaroslav Goiovanov "The Beginning of the Space Era" (English title) *Pravda* October 4 1987 p 3

clear, his study group at the institute had been disbanded in early 1949. Only one person, Igor M. Yatsunskiy, was kept on by Tikhonravov to continue his explorations into possible configurations for the booster. In mid-1949, Yatsunskiy finished a series of calculations determining the relative mass of a three-stage rocket optimized with the specific goal of achieving orbital velocity.⁴⁷ Upon seeing the computations, Tikhonravov requested that Yatsunskiy apply his work specifically to the missiles being developed currently at NII-88 under Korolev — in particular, the still-to-be-built R-3. To coordinate the work more efficiently, Tikhonravov invited Korolev to meet him at NII-4's premises at Bolshevo in July 1949. Korolev was clearly impressed with Yatsunskiy's work, which focused on a launch vehicle composed of three R-3 missiles attached in parallel like a "packet."⁴⁸ Seeing the report, Korolev encouraged Tikhonravov to prepare a formal report addressing the issue of launching a satellite to be presented at the next session of the Academy of Artillery Sciences.

Boosted by Korolev's support, Tikhonravov reestablished a group to study packet-based satellite launch vehicles. The original group with A. V. Brykov, Ya. I. Koltunov, G. Yu. Maksimov, and L. N. Soldatova was set up in late 1949; it was augmented by G. M. Moskalenko and B. S. Razumikhin in 1950 and by I. K. Bazhinov and O. V. Gurko in 1951. All were recent graduates of the N. E. Bauman Moscow Higher Technical School, where special advanced engineering courses on missile design, construction, and engineering had been instituted and taught by such luminaries of the Soviet ballistic missile program as Korolev (1947–49), Glushko (1947–53), Tikhonravov (1947–52), Pobedonostsev, and others.⁴⁹ The lectures themselves were surprisingly interconnected with actual developments within the Soviet rocketry industry. For example, Korolev's own lectures incorporated details of the R-1, R-2, and R-3 missiles, albeit with disguised designations. The courses from this time period were instrumental in training a new generation of young engineers who would join major design bureaus and research institutes and make important contributions to the Soviet space program. Thus, by the time that Brykov, Koltunov, Maksimov, and the others joined Tikhonravov's team during 1949–51, they had solid training in actual and proposed Soviet ballistic missiles, providing a key connection between Korolev's work at NII-88 and Tikhonravov's efforts at NII-4.

The work of the original members of Tikhonravov's newly established group culminated in 1950 with the authorship of what may have been the very first detailed Soviet exposition on the technical prospects and requirements of launching an artificial satellite of Earth. Titled "On the Possibility of Achieving First Cosmic Velocity and Creating an Artificial Satellite with the Aid of a Multi-Stage Missile Using the Current Level of Technology," the paper was formally presented by Tikhonravov at a special session of the Academy of Artillery Sciences on March 15, 1950.⁵⁰ Along with many important military representatives, three engineers from NII-88 were present to hear his speech: designer Korolev, his first deputy Mishin, and planning department chief Bushuyev. Technically based around the idea of using the R-3 missile, Tikhonravov detailed a plan on using a packet-type multistage vehicle capable of launching a

47 I. M. Yatsunskiy "On the Activities of M. K. Tikhonravov in the Period From 1947 to 1953 on Substantiating the Possibility of Creation of Composite Missiles" (English title) *Iz istorii aviatsii i kosmonavтики* 42 (1980) 31–38. An English translation of this article is available as I. M. Yatsunskiy "The Role of Mikhail Klavdiyevich Tikhonravov in Creating Stage Rockets 1947–1953" in John Becklake, ed., *History of Rocketry and Astronautics* Vol. 17 (San Diego, CA: American Astronautical Society, 1995), pp. 451–56.

48 Biryukov "Materials in the Biographical Chronicles" p. 228.

49 Lardier *L'Astronautique Soviétique* p. 79. Yatsunskiy "On The Activities of M. K. Tikhonravov."

50 B. N. Kantemirov "15 July—40 Years From the Report of M. K. Tikhonravov on the Possibility of Achieving Cosmic Velocity Using the Current Level of Technology" (English title) *Iz istorii aviatsii i kosmonavтики* 59 (1989) 65–76. With the phrase "first cosmic velocity" the Russians refer to the velocity required to attain orbit around Earth. The title of the paper has also been reported as "Rocket Packs and Their Development Prospects." See Yatsunskiy "On the Activities of M. K. Tikhonravov."

small artificial satellite. Although he did not specifically mention a timetable, implicit in his words was the possibility of launching a satellite by the mid-1950s if given the requisite support. In an unexpected move, near the end of his monologue, Tikhonravov also raised the issue of launching humans into orbit in the near future using his proposed rocket. The reaction to this presentation was much more negative than the earlier session in 1948. Some in the audience were outwardly hostile to Tikhonravov's ideas, others were silent, and many had sarcastic reactions. Even Mishin himself expressed serious doubts of the technical feasibility of Tikhonravov's plan." There was, in fact, a running joke after the conference that Tikhonravov and a monkey, in each other's arms, would fly off to the Moon." Korolev was one of the few who unconditionally and publicly supported Tikhonravov's ideas.

The March 1950 report precipitated a few extremely fruitful months for Tikhonravov's group. Each participant was given a separate assignment on the development of a Soviet satellite launch vehicle, with the goal of authoring a detailed and comprehensive study on the issue. They studied various configurations of clustered and tandem missiles and devised a special mathematical model for mass analysis based on firsthand information on the R-3 missile provided by Korolev's own engineers. As a result of this work, Moskalenko subsequently authored *Engineering Methods of Designing Missile Dynamics*, while Maksimov completed a report on the ballistic trajectories of an artificial satellite launched by the booster. Advanced studies were also conducted on interorbital transfers and the deorbiting, reentry, and recovery of a satellite. In designing the launch vehicle, Tikhonravov favored a two-stage packet of three R-3s; calculations showed that this configuration would be able to insert a fairly heavy satellite into orbit. The results of all of this work was collated into a massive work consisting of three volumes and published in late 1950. Tikhonravov's own March 1950 paper was also published in a scientific journal in 1951. Despite the voluminous amount of work, Tikhonravov's group was once again disbanded at this time." Although this second setback was temporary, the termination of the launch vehicle effort apparently was related to a number of institutional factors that clearly illustrated the tenuous support for scientific endeavors in a predominantly military industry.

On August 29, 1949, the Soviet Union exploded its first atomic bomb in a desert south of Semipalatinsk in Kazakhstan.' The balance of power abruptly shifted between the two major powers. In the immediate postwar years, Stalin's first and foremost priority was the creation of Soviet nuclear weapons. Although modest rockets were developed during the same period, the missile industry itself did not have the same kind of political imperative as atomic bombs. Always holding a second place in the top-secret armaments industry, in 1949, a missile delivery system finally began to receive a pronounced support, and this support was tied to the nuclear capability. It was painfully clear, however, that the available or planned rockets in the Soviet arsenal such as the R-1 and R-2 were inadequate to satisfy the needs of Soviet defense policy. Neither of these missiles had the capability to carry the heavy nuclear warheads available at the time, nor were they particularly efficient in terms of preparations for launch and targeting. Most critically, they had very short ranges and could only be useful in tactical battles in the European theater. Preparatory work on the R-3 program was ongoing at the time, although

51 Yu A Mozhzhorin *et al* eds *Dorogi v kosmos II* (Moscow MAI 1992) pp 91-103 B N Kantemirov "From the History of Science Flight—His Dreams and Affairs" (English title) *Zemlya i uselennaya* no. 6 (November–December 1991) 54–56

52 Kantemirov "From the History of Science "

53 Kantemirov "15 July—40 Years From the Report" Yatsunskiy "On the Activities of M. K. Tikhonravov "

54 Yu P Maksimov *Raketnyye voyska strategicheskogo naznacheniya uoyenno-istoricheskii trud* (Moscow RVSN 1992) p. 34

CHALLENGE TO APOLLO

even its 3,000-kilometer range was insufficient to cross the Atlantic and reach the shores of what the Soviets considered their number-one enemy.

In this context, in late July 1949, less than a month prior to the first nuclear test, Stalin summoned the top leaders of the missile industry to the Kremlin for a briefing on the state of missile delivery systems. Representing the new rocketry industry were men from both the missile industry and the artillery forces. Also present were Chief Designer Korolev and Igor V. Kurchatov, the famous nuclear physicist and scientific leader of the Soviet nuclear weapons program." As the meeting dragged on into the evening, Col. General Mitrofan I. Nedelin, who headed the Chief Artillery Directorate, and Marshal Nikolay N. Voronov, the chief of Artillery Forces, gave brief reports on the status of efforts to adopt the R-1 as an armament for the Soviet Army. They were followed by Kurchatov, who reported on nuclear weapons development. Korolev was apparently a little nervous when it was his turn, but he explained to Stalin that the R-2 vehicle was almost ready for test launches. He specifically emphasized the advantages of the vehicle over the original German designs, no doubt knowing that Stalin desired something more capable of covering transatlantic distances. In a perhaps apocryphal account of the meeting, Stalin is alleged to have followed Korolev's report with the following tirade:

We want long, durable peace. But Churchill, well he's warmonger number one. And Truman, he fears the Soviet land as the devil's own stench. They threaten us with atomic war. But we are not Japan. That is why you, comrade Kurchatov, and you, comrade Ustinov, and you as well [turning to Korolev] must speed things up. Are there any more questions?"

With the clear message that the political leadership was not happy with the rate of progress, Korolev and Nedelin departed together in silence. For Korolev, it was a double disappointment, for he had apparently intended to speak to Stalin about a "space rocket" capable of traveling the upper reaches of the atmosphere, eventually with humans on board. At the last minute, he omitted his notes on the subject, perhaps for fear that Stalin would see no interest in it. Assuming that Nedelin would be more receptive to it, Korolev briefly told him about Tikhonravov's work at NII-4 and about the level of resistance it was facing from the general scientific community."

Nedelin was not too receptive to Korolev's promotion of Tikhonravov's ideas, irritating Korolev and prompting him to argue even more forcefully. In the end, Nedelin effectively ended the conversation with a warning that no doubt did not fall on deaf ears:

There's no need to be irritated. . . . The history of all this has been well known to me for a long time. You probably don't know this, but our higher Generals have called for the dismissal of Blagonravov from his post as the President of the Academy of Artillery Sciences. Your name has also not been left out.⁵⁸

55 Aleksandr Romanov *Korolev* (Moscow: Molodaya gvardiya, 1996) p. 228. Among those present were Minister of Armaments D. F. Ustinov (who was also the deputy chair of the policy making Special Committee No. 2), Commander-in-Chief of Artillery Forces Marshal N. N. Voronov, Deputy Minister of Armed Forces and former Commander of the Chief Artillery Directorate Marshal N. D. Yakovlev, and recently appointed Commander of the Chief Artillery Directorate Col. General M. I. Nedelin. Note that while Romanov states that Korolev was present at this meeting, another biographer of the chief designer, Ya. K. Colovanov, does not mention this meeting.

56 *Ibid.* p. 229

57 *Ibid.* p. 230

58 *Ibid.* p. 231

Korolev immediately grew gloomy, and the two eventually parted on an unresolved note. Nedelin's words were not only a warning about Korolev's position as chief designer, but also his life itself. The reign of Beriya's secret police had a few more years left to go, and it was with great care and tact that most of the engineers had to negotiate their activities through the innards of the military defense industry. Such was Beriya's logic that if one was not actively working to increase the defensive might of the Soviet Union, then one must be actively engaged in sabotaging it.

Clearly, Korolev's plans for a satellite launch vehicle were not in the interests of either the military or the Communist Party at this point. The tenuousness of Korolev's own position was demonstrated most acutely by a document authored by NII-4 Director Maj. General Nesterenko sometime in 1950. Although he had supported Tikhonravov's early studies, for reasons still unknown, Nesterenko sent a letter directly to the Central Committee suggesting that the work being carried out by Korolev and his engineers at NII-88 on developing A-4-based missiles was essentially a waste of time and resources. He supported his accusations based on the fact that the Germans, using untold materials, had produced about 1,500 of the A-4 missiles, making absolutely no difference to the ultimate outcome of the war. He added a number of criticisms of the A-4 missile itself, including its poor targeting accuracy. Given Nesterenko's important position, the letter might have had dire consequences, had it not been for Ustinov's efforts to "neutralize" the effects of the document.⁶⁰ For Korolev, who somehow found out about the letter, this was unforgivable: it was a grudge he held against Nesterenko to the end of his days.

Whether this event had any influence on Korolev's curiously cool attitude toward NII-4 is unclear, but in 1950, there were some dramatic changes at that institute. The same year, several scholars at NII-4, including Nesterenko, were awarded the USSR State Prize in recognition of their role in developing a system for soft-landing scientific apparatus from a high-altitude missile using parachutes.⁶⁰ Korolev was apparently displeased that NII-4 had received such an honor when his own institute had yet to be recognized for its achievements. By pulling strings, he was able to significantly reduce such work at NII-4. At the same time, cooperation between the institute and other institutions in the military industry were dramatically curtailed. Several important people lost their jobs in this massive reshuffle. Nesterenko was dismissed from his post as NII-4 director, while the president of the Academy of Artillery Sciences, Academician Blagonravov, was demoted to vice president at about the same time in December 1950.⁶¹ Whether Nedelin's warnings about the military's displeasure over Blagonravov's work or Korolev's own offensive against NII-4 was a bigger factor in these dismissals is unclear. Many of the details of the incident still remain obscure. Given Blagonravov's visibly strong support for Tikhonravov's launch vehicle studies, it would seem completely irrational for Korolev to actively lobby for his removal. It is more likely that the changes at the institute were an unlikely and peculiar combination of Korolev's dislike of Nesterenko and the military's displeasure of Blagonravov.

59 Mozzhorin *et al* eds *Dorogi v kosmos I* p 113 A A Maksimov who gives this account recalls that the incident occurred sometime in '1951 or perhaps 1949' Curiously Nesterenko in his own account of the same period does not mention the letter Instead he writes "Looking back I would suggest that if I had not offered Mikhail Klavdiyevich [Tikhonravov] a place to work at my institute and if I had not supported his favorite theme the launch of the first artificial satellite of the Earth may have been delayed for some years" See Mozzhorin *et al* eds *Nachalo kosmicheskoy ery* p 145

60 Mozzhorin *et al* eds *Dorogi v kosmos II* p 91

61 K V Frolov A A Parkhomenko and M K Usokov *Anatoli Arkadyevich Blagonravov Outstanding Soviet Scientists* (Moscow Mir Publishers 1986) p 71 Blagonravov was replaced by Commander in Chief of Artillery Forces Marshal N N Voronov

Tikhonravov was the third person to feel the brunt of the changes. During "a routine check." the Chief Inspectorate of the Ministry of Defense was surprised to find that NII-4 was involving itself in "wholly non-military affairs in an initiatory fashion." The inspectors recommended that Tikhonravov's group be disbanded." Tikhonravov was demoted from his position as deputy director to that of a scientific consultant, a position one of his associates recalls as being like an "honorary banishment." In the ensuing two years, he and his old staff continued to conduct numerical investigations on different variations of multistage missiles and trajectories of artificial satellites, but the impetus that had driven the group from 1949 to 1950 was lost because of these institutional changes. The early efforts of the group did, however, serve as an extremely important base from which the Soviet Union embarked on the creation of an ICBM capable of reaching orbital velocity.

In a curious departure from the pervasive security regarding high-technology efforts, an article authored by Tikhonravov titled "Flight to the Moon" was published in the newspaper *Pionerskaya pravda* in October 1951.⁶⁴ Prominently mentioning the works of Tsiolkovskiy, Tikhonravov adeptly described a two-person interplanetary spaceship of the future and the industrial and technological processes required to create it. He ended the short article, written for young readers, with a clear forecast of the future: "We do not have long to wait. We can assume that the bold dream of [Tsiolkovskiy] will be realized within the next 10 to 15 years. All of you will become witnesses to this. and some of you may even be participants in as yet unprecedented journeys." In perhaps the very first reporting in the West of Soviet space plans, Tikhonravov's article apparently caused quite a stir. It was the subject of a prominent write-up in *The New York Times* two days after the original publication, which explained that:

Dr. Ttkhonravov left no doubt that *Soviet* scientific development in the field of *jet* propulsion and rockets was advancing rapidly. He suggested that this science in the Soviet Union had reached the level at least equaling if not exceeding that in Western *countries*.⁶⁵

It was a rare peek into the shrouded world of Soviet rocketry. The fact that Tikhonravov was allowed to write under his own name on a potentially sensitive topic indicates that the censors viewed the article as of no importance or relevance to national security.

Organizational restructuring was not unique to NII-4. Symptomatic of a broader evolution and maturity in the missile industry. Korolev's home institute, NII-88, was also the center of some dramatic changes. Since his appointment as chief designer of long-range ballistic missiles in 1946, Korolev had continually felt a certain sense of powerlessness in the Ministry of Armaments. At Kapustin Yar, as the technical director of the state commissions, his word was law, and deputy ministers, chiefs of directorates, and other chief designers would literally subordinate themselves in the face of his incredibly assertive personality. On his return to Kaliningrad, however, he would come face to face with an overtly complex bureaucracy comprising several layers in the chains-of-command, which gave him very little in terms of legal and

62 Anatoliy Shiryayev and Valery Baberdin. "Before the First Leap into Space" (English title), *Krasnaya zvezda*, April 27, 1996, p. 5.

63. Kantemrov. "From the History of Science"; Mozzhorin, *et al.*, eds., *Dorogi v kosmos II*, p. 94; Kantemrov. "15 July—40 Years From the Report "

64 M. K. Tikhonravov. "Flight to the Moon" (English title). *Pionerskaya pravda*, October 2, 1951, p. 2. An English translation of the article can be found in F. J. Krieger, *A Casebook on Soviet Astronautics* (Santa Monica, CA: RAND, 1956), pp. 45-48.

65. *Ibid.*

66 "Flights to Planets Forecast in Soviet," *The New York Times*, October 4, 1951

institutional authority. He became another one of several chief designers, often with less ministerial capacity than his other colleagues because he was officially the head of a department within a design bureau, while his contemporaries on the Council of Chief Designers all headed their own bureaus.

For the most part, Korolev's predicament was a result of the institutional peculiarities of the armaments industry, which had essentially been modeled along the lines of the aviation sector. There was a four-step process in project implementation in the creation of aircraft: the scientific research institutes conducted the basic research on a weapon; the design bureaus carried out the engineering work; departments in the military subjected the particular vehicle through a thorough testing regime; and then the product would be declared operational and be formally handed over to the Air Force. In the case of rockets, Korolev believed that such a chain-of-command was not optimal. On many occasions, he had attempted to convince Minister of Armaments Ustinov on the need for total control of the entire process from one centralized entity—that is, his own organization. During one heated conversation, Korolev was particularly explicit:

Dmitriy Fedorovich, you and your deputies are trying to make me a designer of just a missile. Not *even* a missile, but a very large automated cannon shell, to be more precise. Listen, **if** I work as the aircraft designers do, our whole business would collapse very soon. You need to understand: **I** have to be Chief Designer of the whole system. . . .⁶⁷

The disillusionment expressed by both Korolev and his first deputy Mishin was compounded by the fact that the primary thematic direction at the institute was represented by Korolev's department, although its powers were officially limited to the level of that of the several other minor departments at NII-88's Specialized Design Bureau. The bureau's Department No. 3 had clearly outgrown its original mandate by 1950.

The first major change at the institute was precipitated by the departure in the autumn of 1949 of NII-88 Chief Engineer Yuriy A. Pobedonostsev. Ending his extremely fruitful participation in the formation of the postwar ballistic missile programs, in May 1950, he was appointed the rector at the Academy of Armaments Industry.⁶⁸ It was the effective end of a twenty-year career, during which he had played major roles in GIRD, in NII-3, on the recovery teams in Germany, and finally in NII-88. In later years, he participated in the development of early Soviet solid-propellant ICBMs at NII-125. He was a professor at the Moscow Aviation Institute at the time of his death in 1973 at the age of 66. Following Pobedonostsev's resignation, in 1950, at the behest of Korolev, Minister Ustinov agreed to hold a meeting to discuss a complete restructuring of the institute. Attended by Korolev, Ustinov, institute Director Gonor, Chief Engineer Tritko (who had temporarily replaced Pobedonostsev), and his Deputy Chertok, the session was held at an all-night restaurant in Moscow, during which the men hammered out the details of the changes. Ustinov agreed to merge several sectors at NII-88 that were dedicated to anti-aircraft missiles, partly because of their poor performance in the postwar years. At the same time, on April 26, 1950, a number of other departments at the institute were consolidated to create the new Special Design Bureau No. 1 (more commonly known as OKB-1) of NII-88.

67 Golovanov, Korolev, pp. 376-77

68 Valeriy Zharkov, "Pobedonostsev's Criteria" (English title), in V. Shcherbakov, *Zagadki zvezdnykh ostrovo* (Moscow: Molodaya gvardiya, 1989), p. 95; Chertok, *Rakety i lyudi*, p. 344

Korolev was formally named the chief and chief designer of OKB-1, an organization dedicated exclusively to the development of long-range ballistic missiles." Ustinov formally named the thirty-three-year-old Mishin as Korolev's first deputy chief designer, who then was already famous for being a "generator of ideas." Vasilii S. Budnik, a thirty-seven-year-old engineer who was responsible for the missile production programs, was appointed the sole deputy chief designer."

Ustinov enacted further changes in the overall leadership of the institute. Maj. General Lev R. Gonor, who had served as director of NII-88 since its inception in 1946, was relieved of his duties in June 1950." A very opinionated and assertive individual, Gonor had continually clashed with both Korolev and Mishin in the previous years over a variety of technical and thematic issues. There is no doubt that Korolev, with his unpredictable temper and aggressive nature, was responsible for most of these conflicts. Unable to accept subordination to a number of officials such as Tritko, Gonor, Vetoshkin, Ryabikov, and Ustinov, the chief designer was prone to be resistant to any efforts originating from Gonor. The artillery general also had the misfortune of being one of the very few high-ranking Jewish individuals in the rocketry industry. Although there is no evidence to suggest that anti-Semitism played any role in his dismissal, there was clearly a certain degree of prejudice with which he had to deal as director. Without Ustinov's strong support for his candidacy in 1946, Gonor probably would not have been appointed director of such an important institution. Leaving NII-88, Gonor moved to head an artillery plant in Krasnoyarsk. In January 1953, he and many others were arrested during the so-called "Doctors' Plot" and thrown into prison. Other missile men among the incarcerated were several officers from the Chief Artillery Directorate, including its former head Marshal Yakovlev, who had been instrumental in restoring A-4 production in the Soviet Union. Fortunately for those affected, Stalin died only two months later, and Gonor, Yakovlev, and the others were released. Formally rehabilitated, Gonor went on to become the chief of a branch at the Central Institute of Aviation Motor Building at Turayev, near Moscow. He led a very successful career in the aviation industry, which was unexpectedly cut short by the development of gangrene in one of his limbs. He died on November 13, 1969, at the age of sixty-three."

Gonor's replacement at the NII-88 arrived in his office on August 18, 1950, in the person of Konstantin N. Rudnev, a thirty-nine-year-old graduate of the Tula Mechanics Institute. During the war, the soft-spoken Rudnev had served as director of a famous munitions plant. He was received by some apprehension by the engineers at NII-88, but Rudnev's intelligence and modesty apparently soon won over most of the institute's employees. Much less stubborn than Gonor, Rudnev developed a good working relationship with Korolev, Mishin, and others, helped no doubt by his inexhaustible sense of humor. At the time of Rudnev's appointment, there were rumors abounding in the Ministry of Armaments that Korolev would not only head the new OKB-1 but also be named the chief engineer of the entire institute. Fearful about allowing Korolev too much power at NII-88, Minister Ustinov instead invited NII-885 Chief Designer

69. Biryukov, "Materials in the Biographical Chronicles," p. 230. Another bureau, OKB-2, was also established to consolidate all work on anti-aircraft missiles. It was originally headed by Chief Designer Ye. V. Sinilshchikov and later by K. I. Tritko. OKB-2, in its original form, was dissolved shortly after, on August 27, 1951, when all anti-aircraft missile development was transferred from the armaments industry to the aviation industry.

70. Golovanov, Korolev, p. 436. Mishin and Budnik's appointment order was signed on June 16, 1950.

71. Chertok, *Rakety i lyudi*, p. 47.

72. *Ibid.*, pp. 245-46; Mikhail Rebrov, "Return to the Loss of God, or the History of a Man About Whom We Know Almost Nothing About" (English title), *Krasnaya zvezda*, June 21, 1997, p. 6.

Mikhail S. Ryazanskiy to give up his engineering job developing radio-controlled guidance systems to serve as chief engineer of NII-88. It was a peculiar situation because originally Ryazanskiy had been one of Korolev's associates on the Council of Chief Designers. After his formal appointment in January 1951, he effectively served as Korolev's superior as the chief engineer and first deputy director of the institute."

Dogs in Space

It was Korolev himself who served as the chief driving force behind formulating a dedicated plan to loft animals on short vertical flights into the upper atmosphere—a program that directly cleared the way to launch the first human being into orbit. As early as 1948, he began to informally consider ways of lifting human passengers into space using available technology. Inspired by U.S. programs using A-4 and Aerobee missiles for launching animals into space, Korolev mentioned his plans for human spaceflight to famous aviation designer Andrey N. Tupolev during a conversation in late 1948.⁷³ In response, Tupolev gave Korolev the name of Vladimir A. Yazdovskiy, a young physician employed at the Air Force's Institute of Aviation Medicine in Moscow.

The thirty-five-year-old Lt. Colonel Yazdovskiy had graduated from the Tashkent Medical Institute before spending the war as an Army physician. Moving to aviation medicine after 1945, he evidently made quite a name for himself as a bright and resourceful researcher. In January 1949, Korolev telephoned Yazdovskiy, introducing himself as a builder of "special equipment" (it was illegal to make references to military weapons such as missiles over the phone) and arranged a meeting at the



Sergey Korolev in July 1954 is with a dog that just returned to Earth after a lob to an altitude of 100 kilometers on an R 1D scientific rocket. In 1951 the Soviet Union became the first country to safely recover a living organism after a flight in space (files of Asif Siddiqi)

⁷³ Golovanov Korolev p 565. Chertok *Rakety i lyudi* p 349 The option of transferring M S Ryazanskiy from NII 885 was partly the result of a minor conflict with Chief Designer B N Konoplev. Both had independent engineering teams focusing on developing radio controlled guidance systems at the institute. Konoplev had been transferred to NII 885 from NII 20 in April 1950 as a full chief designer in recognition of his role in developing the advanced systems for the new R 3 missile. Konoplev eventually took over Ryazanskiy's vacant post on the Council of Chief Designers.

⁷⁴ Mozzhorin et al eds *Dorog v kosmos II* pp 119-20 The first U S program for launching animals into space used A 4 missiles. Between June 11 1948, and August 31 1950 five A 4s (three of them stretched) were launched from White Sands in New Mexico as part of the Albert and Blossom programs. All except one carried monkeys. Despite reaching a highest altitude of 136.5 kilometers on the last launch, none of the animals were recovered alive. A second program involved Aerobee RTV A 1 missiles. Three were launched between April 18 1951 and May 21 1952. The second flight on September 20 1951 with a monkey and eleven mice was the first U S mission involving the successful recovery of animals after a high altitude flight (just over seventy kilometers).

Petrovsko-Razumovskiy Park near the Institute of Aviation Medicine. Korolev was direct with the young physician, informing him that:

*Andrey Nikolayevich [Tupolev] suggested I contact you about leading a biomedical program in preparation for future flights of spaceships. I would like you to lead this effort, since I don't know what's being done in this area nowadays and what has already been done. . . .*⁷⁵

Yazdovskiy was resistant at first, but Korolev would not take no for an answer: "Oh, come on now Volodya. . . . What's in it for you in all that aviation medicine business? What I'm offering you is far more challenging." Hearing that Yazdovskiy had never seen a launch of a rocket. Korolev replied. "Well, then, if you've seen it once, it'll stay with you for the rest of your life."⁷⁶ Within a few days, Korolev personally arranged with the USSR Minister of Defense Aleksandr M. Vasiliyevskiy to have Yazdovskiy's current work transferred to others, and the physician was given a mandate to begin dedicated biomedical studies in preparation for putting a human into space at an unspecified time in the future. The short-term goals were to use small animals as test beds for gathering medical data on the effects of rocket flight on living organisms.

The director of the Institute of Aviation Medicine, Maj. General Aleksey V. Pokrovskiy, initially assigned a small group of physicians to work under Yazdovskiy, including Boris G. Buylov, Vitaliy I. Popov, and Aleksandr D. Seryapin. At the time, the literature in the Soviet Union on space medicine was almost nonexistent. Thus, the group began its efforts by studying translations of American texts on the subject in detail and identifying the major areas of focus. In designing a payload module for a small animal to fly aboard a modified R-1 missile, Yazdovskiy narrowed down three factors that would play important roles: the environment of vacuum, radiation, extreme temperatures, and meteorites in near-Earth space; the presence of parameters such as vibration, noise, and weightlessness during dynamic flight; and issues associated with the confinement of organisms in a very small space.⁷⁷

In studying these factors, the group also addressed the question of what type of animal to use on the launches. The candidates most appropriate for medical use were initially narrowed down to apes and dogs, but by late 1950, the group began to lean more toward the use of the latter. Apes were considered to be more difficult to dress and were more likely to get colds and other diseases. Furthermore, because they were more excitable than dogs, the doctors believed that they might, for example, bite off important sensors from *their* bodies. The decision to use dogs was formally approved at a meeting of important scientists and physicians at a special session organized by the Academy of Medical Sciences and the Academy of Sciences in December 1950.⁷⁸ Academician Blagonravov, who had just been relieved of his post as president of the Academy of Artillery Sciences, was nominated and appointed chair of a state commission to oversee the actual biological launches. Several famous Soviet biomedicine specialists, such as Vladimir N. Chernigovskiy, Vasiliy V. Parin, and Norair M. Sisakyan, were also inducted as advisors to the commission, emphasizing the importance with which the scientific community viewed the program.

The selection of dogs as test subjects commenced a search to establish criteria for particular types of dogs. Starting with the rationale that the choice had to be satisfactory to both the rocketeers and the biologists, Yazdovskiy's group had to negotiate a number of major obstacles. At the outset, the doctors agreed that at least two dogs would have to be launched in a

75 *Ibid.* p. 120

76. *Ibid.*

77. *Ibid.* pp. 122-24

78 Golovanov. *Korolev*. pp. 545-46; Stache. *Soviet Rockets*. p. 212

common container on each flight because the reaction of one animal would not provide objective results, given the conditions on a particular launch and the peculiarities of the dog. With the constraint of only 0.28 cubic meters of volume, the dogs had to be relatively small and light, somewhere between six and seven kilograms. Experts in dog behavior were consulted, and they reported that small dogs were not compatible with each other, further narrowing the field. The subjects also had to have a high level of resistance and be easily trainable. In addition, the dogs had to have a white or brightly colored coat because the plan was to film the behavior of the animals during flight using a system of mirrors in the poor lighting conditions inside the capsule. Finally, only female dogs were considered because the special anti-gravity suit and sanitation equipment would pose complex problems in the case of males. The requirements were so stringent that at one point one of the "dog catchers" in exasperation told one of the physicians, "Perhaps you'd like them to also have blue eyes and howl in C major?"

Such aspects as the posture of the dogs in flight were carefully planned out prior to launch. Yazdovskiy's team used pairs of dogs in a special centrifuge with self-contained life support systems to ascertain that a vertical posture would probably kill the animals because of the high rates of acceleration in the initial stages of flight. Equipment for monitoring the physiological behavior of the dogs was culled from a variety of sources, including a local military college and the Krasnogorsk Mechanical Optical Plant, which manufactured a camera capable of holding 120 to 300 meters of film.⁸⁰

At Korolev's department at Nil-88, the design of modified R-1 missiles and a special container to carry the small animals had formally began on December 30, 1949, as part of a coordinated project to develop different variants of the rocket for scientific purposes. The chief of the planning sector at Korolev's section, Konstantin D. Bushuyev, was appointed to lead the team that would design two new modifications of the R-1, designated the R-1B and R-1V. The design of both the rockets and the payload evolved over 1950 and 1951, with significant interaction between Yazdovskiy's group at the Institute of Aviation Medicine. Both visually and technically, the new missiles were markedly different from their predecessor, the R-1A missile. They incorporated many of the mechanisms developed for the R-2 ballistic missile and had a much more sleek appearance than the R-1A. Each missile was 17.55 meters in length with a base diameter of 2.56 meters, dimensions significantly exceeding the R-1A. Total liftoff mass was about 14.32 tons.⁸¹ The total mass of the experimental payload of the vehicle was set at 1.160 kilograms, of which 590 kilograms was the actual container carrying the dogs.

Engineers under Bushuyev spent a significant amount of work designing a container that could be safely recovered. They modified the original nose cone separation mechanism from the R-1A and raised the reliability of the parachute system during preflight tests. Auxiliary air brakes were introduced to decrease the rate of descent prior to the opening of the parachute, primarily to reduce deployment shock. The new rockets also incorporated improved telemetry systems because the most important aspect of the mission would be the data recorded during the flight. This in turn necessitated a more accurate orientation and stabilization system. The end result of the R-1B/R-1V design program in 1951 was the development of a standard nose cone payload section that could be used in a variety of configurations for different requirements." In addition to the main payload container, the R-1B carried two eighty-five-kilogram

79 Stache *Soviet Rockets* pp 212-13 Evgeny Riabchikov *Russians in Space* (Garden City NY Doubleday 1971) p 140

80 Mozzhorin et al eds *Dorogi v kosmos II* pp 126-27

81 Keldysh ed *Juorcheskoye nasledie akademika Sergeya Pavlovicha Koroleva* p 536 Biryukov 'Materials in the Biographical Chronicles' p 229

82 Stache *Soviet Rockets* p 213

scientific modules that were attached longitudinally to the sides of the main body of the missile. These were designed by the Geophysical Institute of the USSR Academy of Sciences, and they contained a number of instruments for studying the upper atmosphere. The R-IV, identical in all other respects, carried a large parachute system in place of the science modules to enable engineers to recover the 4,160-kilogram main body of the rocket.

In mid-summer of 1951, the state commission, headed by Blagonravov, Yazdovskiy, and other representatives from the Institute of Aviation Medicine, and engineers from OKB-1, led by Korolev, converged at Kapustin Yar for the first Soviet attempt at launching a living organism into space. A total of nine dogs were selected to form the core pool, including Albina (Russian for White), Bobik, Dezik, Kozyavka (Gnat), Lisa, Malyshka (Little One), Smelaya (Bold), and Tsygan (Gypsy).⁸³ Yazdovskiy chose Dezik and Tsygan for the first flight, set for July 22, 1951. The launch, using an R-IV, was held during the early morning hours so the rocket would be illuminated by the Sun during the ascent portion. Preparations for the launch were conducted in a mood of unconcealed excitement and anxiety, and following Blagonravov's formal approval, the rocket finally lifted off in a roar amid the dust of Kapustin Yar, carrying its two canine passengers. During their flight, the animals reached a velocity of 4,200 kilometers per hour and an altitude of 101 kilometers, and they experienced four minutes of weightlessness. Approximately 188 seconds following launch, the payload section separated from the main booster and went into freefall until it dropped to an altitude of six kilometers, at which time the parachute successfully deployed. Yazdovskiy had personally asked all the members of the state commission to remain at their viewing positions until the dogs had landed, but about twenty minutes following launch, a white parachute was visible in the sky, and everyone at the launch site rushed to their cars, driving off into the desert in a cloud of sand. At the landing site, the cabin hatch was hurriedly unscrewed, and both dogs were found barking and wagging their tails. Although Dezik was in perfect condition, Tsygan had apparently sustained a minor injury on her belly when the inner compartment had curved in upon impact.⁸⁴ The dogs were the first living organisms successfully recovered after a flight into space, coming two months before the United States achieved a similar feat.

This first historical launch was followed by an unevenly successful program. The second of six total missiles, this one an R-1B, carried Dezik on her second flight with a new dog, Lisa, on July 29. Unfortunately, the pressure sensor used to trigger the parachute system had been damaged by vibration, and both dogs were killed upon impact on the steppes of Kapustin Yar. The on-board data recorders were, however, successfully salvaged.⁸⁵ Korolev himself was apparently greatly grieved by the loss. The third launch almost did not go off. One of the dogs chosen for the flight, Smelaya, unexpectedly ran loose the day before launch, causing great consternation among the specialists that she had met her fate at the jaws of jackals, which were known to roam the area. Fortunately, the next morning, Smelaya returned to the launch site, quite safe, and the launch went off on time. Both dogs survived and were recovered successfully. One of the dogs slated to fly on the sixth and final flight once again disappeared during a walk prior to launch. Yazdovskiy ordered Seryapin to search for a replacement, and the latter went to the local canteen and picked up one of the dogs that were known to frequent the place, making sure that she was suitable in size and temperament. With no previous documentation, Korolev opted to give her the name ZIB, the Russian acronym for "Substitute for Missing Dog Bobik." With minimal training, she and another dog were successfully launched on September 3 on a completely successful mission, reaching an altitude of 100 kilometers and

83. Riabchikov, *Russians in Space*, p. 141.

84. Frolov, Parkhomenko, and Usokov. *Anatoli Arkadyevich Blagonravov*, pp. 144-45; Mozzhorin, et al., eds., *Dorogi v kosmos. II*, p. 127.

85. Colovanov, *Korolev*, p. 547.

finishing the program." In total, nine dogs were flown on six launches, three of them flying twice.

Despite four dog fatalities, the results of the R-1BIR-IV launch program were encouraging.⁸⁷ Data gathered on a four-channel recorder included information on fluctuations of skin temperature and pulse and on cabin pressure and temperature. Film from the movie camera proved extremely useful in observing the behavior of the dogs in flight. In addition, before and after the missions, physicians obtained an electrocardiogram, an x-ray of the thorax, conditional food reflexes, and data on body mass. The flights also introduced the first fully functioning life support system for organisms in Soviet rocketry, consisting of a seven-liter globe filled with a mixture of 70 percent air and 30 percent oxygen. A soda lime cartridge was used to absorb exhaled carbon dioxide, and a silica gel cartridge was used as a desiccant. Among nonbiomedical experiments, the launch of August 15 was the first time that Soviet instruments were used to study the spectral composition of solar shortwave radiation from an altitude of 100 kilometers." For Blagonravov, the launches had one important result. After the second launch, when Dezik and Lisa had been killed, Blagonravov had decided that Tsygan, who had been Dezik's partner on the first flight, should not fly again. Instead, in early September, he took the lone dog back to Moscow and adopted her as his own. Tsygan lived to a great old age, and Blagonravov and the dog would often be seen walking the streets of Moscow, both clearly very much attached to each other."

The vertical dog flights of 1951 opened up the era of space biomedicine for the Soviet Union. At the same time, there was also a significant expansion of the use of ballistic missiles for the study of the upper atmosphere. Under Academician Blagonravov's chairmanship, the Commission for the Investigation of the Upper Atmosphere submitted a formal report in 1951 describing a full-scale program for high-altitude scientific research. Using available R-1-based missiles as a limiting factor, an eight-point program was put forth that encompassed the following:

- Investigations on the chemical composition of air at high altitudes
- The determination of wind velocity
- The development of methods for determining ionization density
- Investigations into the composition of primary cosmic radiation and its interaction with matter
- Spectral measurements of solar radiation
- Research on aerodynamics, boundary layer structures, and surface resistance
- Research on life functions of animals at high altitudes
- The development of integrated recovery systems"

86 Mozzhorin *et al.* eds. *Dorogi v kosmos II* p 128. The launch dates and results were as follows

Rocket	Date	Rescue of Payload	Rescue of FIAR-1	Rescue of Dogs
R-IV	July 22 1951	yes	yes	yes
R-1B	July 29 1951	no	no	no
R-1B	August 15 1951	yes	yes	yes
R-IV	August 19 1951	yes	no	yes
R-1B	August 28 1951	no	yes	no
R-1B	September 3 1951	yes	yes	yes

See B. V. Raushenbakh ed. 5. *P. Korolev i ego delo: suet i teni v istorii kosmonautiki: izbrannyye trudy i dokumenty* (Moscow: Nauka, 1998) p. 547

87 Sernenov ed. *Raketno Kosmicheskaya Korporatsiya* p. 35

88 George Wukelic ed. *Handbook of Soviet Space-Science Research* (New York: Gordon and Breach Science Publishers, 1968) pp. 16-17, 19-20. C. S. Ivanov, Kholodnyy and L. A. Vedeshin, "First Rocket Experiments for Research on Solar Short wave Radiation," in Frederick I. Ordway III ed. *History of Rocketry and Astronautics*, Vol. 9 (San Diego: American Astronautical Society, 1989) p. 191

89 Golovanov. *Korolev* p. 547. Stache. *Soviet Rockets* p. 216

90 Stache. *Soviet Rockets* p. 211

CHALLENGE TO APOLLO

Visits to the Kapustin Yar range were frequent for engineers at OKB-1. Although the launches of the R-1B and the R-1V were no doubt important for the scientific community, of much greater significance was the testing in support of the military ballistic missile program. An intensive effort had been expended in late 1950 during the first series of launches of the new R-2 missile. A second series, again directed by Korolev, was carried out between July 2 and 27, 1951, at the same time that dogs were being lofted into space from the same site." Of the total of thirteen launches in the series, a remarkable twelve successfully reached their targets, finally allowing engineers to put the results of the dismal first series behind them. The Soviet armed forces formally adopted the R-2 missile as operational armament by an order dated November 27, 1951—a decision that emphasized the overriding needs of the military to operate a battle-ready long-range ballistic missile system." The R-2 was, in fact, a vast improvement over the R-1—in particular, in areas such as ease of training and operation and the capabilities of its guidance system. With a range of 600 kilometers, it could reach twice as far as its predecessor, although it was still incapable of carrying the heavy nuclear weapons in existence at the time.

With the adoption of both the R-1 and the R-2 missiles in the armed forces, the overseeing Special Committee No. 2 addressed the need for establishing a new production facility for manufacturing the vehicles in quantity. After much discussion, the committee decided on May 9, 1951, to transfer a large factory in the Ukraine, the Dnepropetrovsk Automobile Plant, to the jurisdiction of the Ministry of Armaments. Since July 1944, the plant had been manufacturing automobiles, tractors, and other heavy machinery—at first in support of the war effort, but later for civilian purposes. After its transfer, the facility was formally named the State Union Plant No. 586 in 1952. In the interest of coordinating all manufacturing work with OKB-1, Korolev transferred one of his leading assistants, Deputy Chief Designer Budnik, to the newly reorganized plant on July 6, 1951. Budnik, the very first of many of Korolev's proteges to become chief designers in their own right, was instrumental in leading all the engineering aspects of manufacturing the R-1 and R-2 missiles.⁹³ Within twenty years, the plant at Dnepropetrovsk was to become the largest missile and space launch vehicle manufacturing facility in the entire world.

Themes

The R-3 project, begun in 1949, served as the starting point for preliminary studies into possible configurations for the first Soviet ICBM. As Korolev emphasized in his draft plan for the R-3, the 3,000-kilometer-range missile was seen as a stepping stone to more ambitious rockets. Concurrent with the early work on the R-3 during 1949–50, engineers at NII-88 were, in fact, engaged in formulating a long-range strategic plan for the institute—one that would dictate the general nature of work on Soviet long-range missiles for some time to come. By the end of 1950, this plan encompassed three specific areas of focus or "themes," as Soviet engineers called them:

- Theme N1 called for the design of a new one-stage missile with a range of 3,000 kilometers.
- Theme N2 called for the creation of a missile using storable propellant components.
- Theme N3 focused on exploratory research in developing a Soviet ICBM.

91. Biryukov. "Materials in the Biographical Chronicles," pp. 230–31.

92. Sergeyev, ed., *Khronika osnovnykh sobytiy*, p. 34. A final series of fourteen R-2 missiles was launched between August 8 and September 18, 1952, of which only two failed to reach their targets. By this time, the vehicle had a success rating of 86 percent.

93. V. Pappo-Korystin, V. Platonov, and V. Pashchenko. *Dneprovskiy raketno-kosmicheskii tsentr* (Dnepropetrovsk. PO YuMZ/KBYu, 1994), pp. 52–53. Production for the R-1 and R-2 missiles was transferred to the plant by personal order of Minister of Armaments D. F. Ustinov on June 1 and November 30, 1951, respectively.

The USSR Council of Ministers formally approved this new research program under the title "Complex Research and Determination of the Basic Flight-Tactical Characteristics of [Long-Range Ballistic Missiles]" by an official governmental decree dated December 4, 1950.⁹⁴ Chief Designer Korolev was the overall scientific leader.

The NI theme subsumed the already concurrent work on the ambitious R-3 missile, which was specifically geared toward two design innovations: the use of integral tanks for both propellants and the elimination of graphite rudders for guidance. Both of these were to be tested on the experimental R-3A missile. By 1951, NII-88 had prepared "The Plan for the R-3A Experimental Missile With an Improved Range of Flight," the final technical document containing the workshop drawings for manufacturing the rocket. The flight testing of the missile was set to begin from Kapustin Yar in October 1951.⁹⁵ The schedule for the R-3 program, however, proved to be overly optimistic. Given the technological leap required for the R-3 program, it is not surprising that Soviet engineers ran headlong into some seemingly insurmountable problems, bringing the effort to an impasse within two years of the start of the project. One official historian of NII-88 recalled later that:

... serious stumbling blocks prevented the [R-3] engines from being developed in time — when it became clear that these problems would lead to enormously delaying the production of the R-3 missile. Korolev was blamed for an unrealistic objective statement. Critics said that a range of 1,000 km ought to have been assigned, and the rocket model should have been [progressively] evolved as it had been with the R-2 rocket, which had been advanced to a preset standard through a certain number of modifications."

For his part, Korolev, put the blame squarely on Glushko's shoulders, believing, with some validity, that Glushko had erred seriously by trying to scale up the old German A-4 engine to create the RD-110 engine for the R-3.

Glushko's primary problem seems to have been due to the use of the new liquid oxygen (LOX) and kerosene combination. The new pairing, while being more efficient than the LOX-alcohol duo, resulted in a higher combustion chamber pressure, which meant that the walls of the chamber had to be thicker. This in turn would make the engine heavier. More damaging for the RD-110 were the problems in cooling the engine, the requirements for which were much more stringent than for the German A-4 engine. Cooling required thin combustion chamber walls, which would not stand up to the higher internal pressures. Put in a difficult position, Glushko had to resort to adopting an idea from another noted engine designer. Chief Designer Aleksey M. Isayev, who during his stint at NII-1 in the mid-1940s had performed some groundbreaking research on high-thrust liquid propellant rocket engines. Isayev's idea, derived from work at the Gas Dynamics Laboratory and by the German scientist Sanger in the 1930s, was to use a so-called "integrated solder-welded" design, which had thin "ribs" around each combustion chamber to allow coolant to pass around the chamber. Such a design circumvented major cumulative problems of operations at high pressures, temperatures, and heat fluxes, while generating the required high specific impulses.⁹⁷

94. Avduyevskiy and Eneyev, eds., M. V. Keldysh, p. 139; Ishlinskiy, ed., *Akademik S. P. Korolev*, p. 302; Semenov, ed., *Raketno-Kosmicheskaya Korporatsiya*, p. 630. The title of the overall program is given in Keldysh, ed., *Tvorcheskoye naslediyе akademika Sergeya Pavlovicha Koroleva*, p. 319. An alternate title, "The Prospects of the Development of Long-Range Missiles," is given on p. 328 of the same text. For general descriptions of the three themes, see Mozzhorin, et al., eds., *Nachalo kosmicheskoy ery*, pp. 71, 261; Mozzhorin, et al., eds., *Dorogr v kosmos*, I, pp. 107-08.

95. Biriukov, "The R-3 Rocket Project Developed in the U.S.S.R.," Biryukov, "Materials in the Biographical Chronicles," pp. 230-31; Semenov, ed., *Raketno-Kosmicheskaya Korporatsiya*, p. 40.

96. Biriukov, "The R-3 Rocket Project Developed in the U.S.S.R.," p. 197.

97. V. I. Prishchepa, "History of Development of First Space Rocket Engines in the USSR," in Ordway, ed., *History of Rocketry and Astronautics*, pp. 95-98.

CHALLENGE TO APOLLO

Clushko had evidently begun work on such a design by the late 1940s. In mid-1947, he tested a technology demonstrator with a thrust of seven tons and an initial gas pressure of sixty kilograms per square centimeter. A second experimental chamber, designated the KS-50, had a thrust of fifty kilograms. Used for testing with various propellant combinations, it was fired successfully for the first time on April 26 of the same year." While the new design was a positive step in Soviet rocket engine development, the goal of designing a single chamber LOX-kerosene engine with a ground thrust of 120 tons eventually proved to be "problematical" for Clushko's design bureau. Vibration-related explosions during testing continually delayed RD-110 development, and there were reasons to believe that the overall project might be delayed by as much as two years. By 1951, a full four years after work on the RD-110 had begun, Clushko had successfully carried out only hydraulic testing of its huge combustion chamber, the turbopump, the gas generator, and some subsystems. There had still been no integrated ground tests. By the end of the year, Clushko had temporarily suspended the continuing development of the RD-110. Work on the D-2 competitor engine (by Chief Designer Polyarniy at NII-1) "was also unsuccessful, due to excessive innovations introduced into the project."⁹⁹

The problems with the engines for the R-3 forced Korolev to completely reassess his priorities. Having promised the Soviet armed forces a 3,000-kilometer missile, he was unable to provide anything more than the modest 600-kilometer-range R-2 rocket. In a typically shrewd move, in the spring of 1951, Korolev turned his attention to the experimental 900-kilometer-range R-3A missile, which was close to flight testing. Using the latter as a prototype, would it not be possible to marginally augment its systems and create a "new" missile with a range of about 1,200 kilometers? He set his engineers to work on the problem, and within months, by October 30, 1951, they completed the draft plan for the new missile, designated the R-5. It would heretofore be known as the "first Soviet strategic rocket."¹⁰⁰ Given that, unlike the R-3, this strategic missile was the result of incremental improvements in already existing Soviet rockets, Korolev and the military seemed to have had much more confidence in the new program than they did in the far too ambitious R-3. Because the development of the R-5 was performed as part of the original NI theme, there was no formal approval of the program from the Soviet government. An official USSR Council of Ministers decree on February 13, 1953, for the first time mentioned the rocket in a document that specified timetables for its testing.¹⁰¹

The R-5 missile incorporated many of the design characteristics originally earmarked for the R-3 and, as such, served as a harbinger of many new innovations in the evolution of Soviet rocket design. For example, engineers developed a new set of reinforced servo components and speedier operating servomotors for the small aerodynamic rudders to compensate for the reduction in the size of the main stabilizing fins. The guidance system for the missile, developed at NII-885 under Chief Designer Pilyugin, used longitudinal acceleration integrators, which allowed improved precision to time engine cutoff, thus improving targeting accuracy. A team at NII-88 developed special thermal shielding for the warhead, which was expected to reenter the

98. V. A. Volodin, "2 September—80 Years Since the Birth of Academician V. P. Glushko (1908)" (English title), *Iz istorii aviatsii i kosmonavтики* 59 (1989): 82-92. For a discussion of the KS-50 and the RD-110, although neither are named, see V. I. Prishchepa, "From the History of the Creation of the First Space Engines (1947-1957)" (English title), in B. V. Raushenbakh, ed., *Issledovaniya po istorii i teorii razvitiya aviatsionnoy i raketno-kosmicheskoy nauki i tekhniki* (Moscow: Nauka, 1981), pp. 128-29.

99. Biriukov, "The R-3 Rocket Project Developed in the U.S.S.R.," p. 198; Prishchepa, "From the History of the Creation," pp. 123, 129. For the D-2, see also V. Davydov, "The Contribution of N. G. Chernyshev in the Development of Rocket-Space Technology" (English title), *Novosti kosmonavтики* 19 (September 9-22, 1996): 58-61.

100. Semenov, ed., *Raketno-Kosmicheskaya Korporatsiya*, pp. 40, 46, 630. Biryukov and Yeremenko, "50 Years for the Native Rocket-Space Industry."

101. Semenov, ed., *Raketno-Kosmicheskaya Korporatsiya*, p. 46. The testing would be performed in three stages—the first two being experimental stages and the last being a targeting series.

upper layers of the atmosphere at a velocity of 3,000 meters per second, far in excess of anything previously built. Because both of the propellant tanks were integral components of the missile frame, the rocket had a markedly different appearance from the predecessor R-1 and R-2 vehicles. There was a one-ton reduction in design mass compared to the R-2, with a concurrent increase of 60 percent in the propellant mass. The propellant-to-mass ratio was thus increased from 4.2 to 6.6 in the new missile. The propulsion unit for the R-5 was the new RD-103 engine, a modified variant of the RD-101 used on the R-2. Developed by OKB-456 under Glushko, the new single-chamber engine had a vacuum thrust of fifty-one tons, a 60-percent increase over the earlier model. The performance parameters were at the upper limits then possible by the Soviets using LOX and alcohol. Unlike both the R-1 and R-2 vehicles, the R-5 had a sleek completely cylindrical frame and a high aspect ratio of 12.5 (as compared with 10.7 for the R-2).¹⁰² All of these factors aided in significant improvements in the range of the missile, despite a generally similar overall size. The most advanced Soviet missile in existence at the time, the R-5 was 20.74 meters in length and 1.66 meters in base diameter. Total liftoff mass was 28.57 tons. The initial requirements specified that the missile be able to carry a one-ton explosive a distance of 1,200 kilometers.

In preparation for the first launch of the R-5 missile, Korolev flew out from Moscow on March 5, 1953. Arriving at Kapustin Yar, he was told that after almost thirty years of ruthless rule over the Soviet Union, Stalin had finally passed away in the Kremlin. It was a crushing blow for millions of Soviet citizens whose personal feelings on the Soviet leader withstood the test of the devastating Purges, the innumerable labor camps, and the breakdown of civil society. Still unaware of Stalin's personal role in the secret police's reign of terror, or perhaps unwilling to believe in it, the ensuing days were spent in shock at the uncertain prospects for the future of the Soviet Union. As a man wholly of his times, Korolev was one of those who mourned deeply over the death. In a series of letters to his wife in early March from the launch site, he wrote not only about his own personal loss, but also of the collective blow to the future of the Soviet nation.¹⁰³ As the future of the ballistic missile program was threatened by uncertainty, engineers from the various design bureaus and institutes continued to prepare for the first R-5 launch.

The first launch was initially planned for March 13, but weather reports for that day described the threat of heavy cloud cover, prompting the commander of Kapustin Yar, Maj. General Voznyuk, to postpone the launch. As on other occasions, the weather reports eventually turned out to be wrong, and Korolev directed the launch attempt on Sunday, March 15, ten days after Stalin's death. The rocket never reached its target, and the flight was deemed a failure. By this time, Korolev had caught a bad cold, culminating in a severe fever, which raised the question of postponing further launches. Korolev managed to endure through to a second launch attempt on March 18, which also failed, but by then he was in dire need of professional medical treatment. He was put on the next train back for Moscow and was visited there by Minister of Armaments Ustinov, who found him haggard and sickly looking. Spiritually, he had also been dealt a personal loss from Stalin's death. Eventually, his health returned to normal, and Korolev immediately returned to Kapustin Yar in time for the third launch attempt on April 2. For the first time, the missile successfully flew a nominal flight, thus signaling the introduction of a new generation of ballistic missiles in the Soviet arsenal. Despite minor failures, the first series of R-5 launches eventually ended formally on May 23, 1953, with the eighth

¹⁰² Stache *Soviet Rockets* pp 180-82 The ballistic coefficient, the ratio of the mass of the rocket to the cross sectional surface area of the rocket in the direction of flight, was also increased to 13 240 kilograms per square meter (as compared to 9 500 kilograms per square meter for the R 2)

¹⁰³ Colovanov Korolev p 422 Mariya Pastukhova "Brighter Than Any Legend" (English title) Ogonek 49 (December 1987) 18-23

launch. A second series of seven launches occurred between October 30 and December 9, 1953, also from Kapustin Yar. Of a total of fifteen missiles launched during the two series, only two vehicles failed to reach their final targets—an unprecedented level of success and a tribute to the rapidly accumulating engineering prowess of Soviet rocketry engineers." By the end of 1953, a final test series, to debug modifications enacted as a result of the first launches, was set for the middle of 1954.

The N1 theme initially encompassed the R-3, then the R-3A, and finally the R-5. The N2 theme, carried out during the very same period at OKB-1, resulted in a new and revolutionary area of research for the Soviet rocketry industry: the use of storable propellants. By the late 1940s, armed forces officials were expressing concern over the limitations in using missiles propelled by cryogenic or supercooled propellants. Because LOX had to be maintained at extremely cold temperatures, if rockets such as the R-1 or R-2 were left on the launch pad for long periods, then propellant would begin to boil off. This made handling the missiles an extremely cumbersome and lengthy affair, as troops spent an inordinately long time in maintaining the missiles. To circumvent the problem, Korolev initiated theme N2 to develop a short-range tactical rocket with the performance characteristics of the modest R-1, but which used hypergolic (that is, self-igniting and storable) propellants.

Chief Designer Isayev at NII-1 originally conducted research in this field in the immediate postwar years. Isayev's group had studied a small eight-ton-thrust engine originally developed by German engineers for the Wasserfall surface-to-air missile. Work on developing a copy of the engine had begun in 1946 in support of the creation of a Soviet copy of the Wasserfall, designated the R-101. Ground tests of the engine, in the beginning unsuccessful, had begun at NII-1 premises in February 1948 under Isayev's direction. Unhappy with the state of support for rocket engine research at the institute, his entire twenty-two-person department was transferred to NII-88 by an order dated July 1, 1948.¹⁰⁵ Based in Kaliningrad, Isayev formally assumed the role of chief designer of NII-88's Department No. 9. The switch from the aviation sector (which controlled NII-1) to the armaments sector (which controlled NII-88) clearly put Korolev and Isayev into close contact, uniting them for work on the N2 theme. Testing of the Wasserfall engine continued under the new institutional arrangements as Isayev designed a modified unit composed of four motors designated the U-2000. In August 1950, he carried out its first successful ground test firing." Although the R-101 program was eventually terminated in 1950, the successful performance of Isayev's engine prompted Korolev to join forces to develop a modified version as part of the N2 theme.

Isayev, forty-three years old in 1951, was one of the most talented engineers in the Soviet rocketry industry. His original claim to fame had been as one of the co-designers of the famous BI-1 aircraft, one of the first Soviet rocket-planes, which had flown its first test flight in May 1942. Through the war, he had continually set the standard for high-performance engines. Later, Isayev had been one of the first qualified engineers to scour through the remains of the A-4 facilities in Germany and had been instrumental in setting up initial production runs there, before handing that job over to the more powerful Glushko. While Isayev's appointment as the technical leader for storable engines was not a threat to Glushko, it was clearly a sign that

¹⁰⁴ Colovanov Korolev p 424 Biryukov "Materials in the Biographical Chronicles" pp 232-33; Chertok *Rakety i lyudi* p 374

¹⁰⁵ V K Kupriyanov and V V Chernyshev *U uechernyy start rasskaz o glavnom konstruktorye raket nykh dvigateley Alekseye Mikhaylovichye Isayeuye* (Moscow: Moskovskiy rabochiy, 1988) p 219. Another source says that the transfer occurred in May 1948. See Yu A Mozzhorin "The Central Scientific Research Institute of Machine Building—The Chief Center for the Soviet Rocket Space Industry" (English title) *Iz istorii aviatsii i kosmonavtki* 60 (1990) 20-40

¹⁰⁶ Kupriyanov and Chernyshev *U uechernyy start* p 219

industrial leaders did not want to put their faith in one designer alone. Soon after the 1950 reorganization at NII-88, in recognition of Isayev's work, his department was restructured into the Special Design Bureau No. 2 (OKB-2).

The rocket that Korolev and Isayev built as part of the N2 theme, known as the R-11, was built in a remarkably short time period. Its main engine was the S2.253, developed on the basis of the old German Wasserfall engine, which used nitric acid and a kerosene derivative as propellants. The missile was flown in three series of tests from 1953 to 1955 and formally adopted for operational use by the military on July 13, 1955.¹⁰⁷ In time, the R-11 completely replaced the use of the R-1 missiles in the Soviet Union. More significantly, for the first time, military commanders were alerted to the value of using hypergolic and storable propellants in missiles for combat applications instead of more high-energy components such as LOX. Isayev's experience in using these propellants also contributed significantly to the future success of the Soviet space program. His OKB-2 would be assigned to develop spacecraft engines for the first Soviet piloted spacecraft. The R-11 missile itself had an interesting future. It was extensively used in several modified versions in war conditions by many other nations, including Egypt during the 1973 war against Israel and Iraq during the Persian Gulf war in 1991. In its later incarnations, it was given the general North Atlantic Treaty Organization (NATO) designation Scud-B.¹⁰⁸ For Korolev, the development of the R-11 seems to have been more of a diversion than anything else. As one historian noted, "he regarded it with a reserved coldness, realizing that the Army needed it and was waiting for it, and that he himself needed it in order to reinforce the positions of the OKB, but nothing more."¹⁰⁹ Korolev's real dream was the creation of an ICBM—one that could reach orbital velocity—and it was theme N3 that focused on this particular issue.

Designing the ICBM

All three of the themes—N1, N2, and N3—were carried out simultaneously at three organizations: NII-88's OKB-1 under Korolev, the Ministry of Defense's NII-4 led by Nesterenko and later Chechulin, and the Department of Applied Mathematics of the V. A. Steklov Mathematics Institute (OPM MIAN) headed by Academician Keldysh. The N3 theme was officially called "Research on the Prospects of Creating [Long-Range Missiles] of Various Types With a Range Flight of 5,000–10,000 km with a Warhead with a Mass of 1–10 Tons."¹¹⁰ Both winged and ballistic configurations were examined in the study.

For the ballistic option, focused on the development of an ICBM, work was specifically geared toward creating a multistage missile using LOX and kerosene with a capability of carrying a payload of three to five tons over 7,000 kilometers. The starting point for the ICBM

¹⁰⁷ Sergeev ed. *Khronka osnovnykh sobytii* p. 35. The tests occurred between April 18 and June 3, 1953, then between April 20 and May 13, 1954, and finally between December 1954 and February 1955.

¹⁰⁸ A nuclear tipped version named the R-11M was also later developed by OKB-1. Testing of this version was conducted between December 30, 1955, and January 19, 1956, then between March 25 and April 11, 1957, and finally between August 8 and September 2, 1957. This vehicle was declared operational by an order dated April 1, 1958. The lead designer of the R-11M was M. F. Reshetnev, a young engineer at OKB-1 who later served as head of the one of the most prolific satellite building organizations in the world, the NPO Pribladnoy mekhaniki at Krasnoyarsk 26.

¹⁰⁹ Yaroslav Golovanov, "Portrait Gallery: Underwater Thunder" (English title) *Poisk* 18 (May 1990): 6.

¹¹⁰ This title is given in Semenov ed. *Raketno-Kosmicheskaya Korporatsiya* p. 73. A different title is given in Biryukov, "Materials in the Biographical Chronicles," p. 230. See also Boris Nikolayevich Kantemirov, "The History of the Selection of Design Principles for the First ICBM—the R-7" (English title) presented at the 10th International Symposium on the History of Astronautics and Aeronautics, Moscow State University, Moscow, Russia, June 20–27, 1995.

effort was Tikhonravov's ground-breaking research at NII-4, where he developed the so-called "packet" concept of clustering together several missiles into one unit. In examining the packet scheme, Tikhonravov's group had emerged with two particular variants: the "simple packet" and the "complex packet." The former, which was favored by Korolev, had independent systems for each separate strap-on; the boosters would only be connected mechanically. In the more sophisticated complex packet, supported by Tikhonravov, the boosters would not only be connected mechanically, but all systems, such as the propulsion and hydraulic elements, would be interconnected and function in conjunction with one another.¹¹¹

General mathematical calculations by Tikhonravov's group proved that the simple packet, despite its elegance, would be much heavier than the more sophisticated complex packet arrangement. Korolev, however, continued to support the simpler configuration, and the NII-4 team prepared two reports in 1951 on the variant, without making any attempt to optimize the design in search of improving its mass characteristics. Tikhonravov was evidently so opposed to the simple packet that he declined to carry out this optimization for Korolev; instead, he continued to support the complex scheme. The minor rift created an obstacle for further research, and seeing a possible deadlock, Korolev requested Keldysh's team at the Department of Applied Mathematics to carry out the much-needed optimization. This department at the time was staffed by a group of young, recently graduated mathematicians who were only too eager to put their skills to work. Known informally as "Keldysh's boys," they were led by twenty-eight-year-old Dmitriy Ye. Okhotsimskiy, alumnus of the N. Ye. Zhukovskiy Central Aerohydrodynamics Institute (TsAGI), and included, among others, Timur M. Eneyev, Sergey S. Kamynin, Vasily A. Sarychev, Galina P. Taratynova, and Vsevolod A. Yegorov, all of whom had been recruited to work in the relatively new field of missile engineering.¹¹²

The young team's results were summarized in 1951 in a long report authored by Keldysh, Kamynin, and Okhotsimskiy titled "Ballistic Possibilities of Multistage Missiles." It examined a variety of configurations, including simple one-stage models and Tikhonravov's packet schemes. In inspecting the cluster scheme, the scientists carried out detailed comparisons using the R-2 or R-3 missile as the basic block of each packet. The calculations proved that the R-2-based variant would not satisfy the necessary payload and range requirements. On the other hand, in their investigation of Korolev's favored simple packets of three or five R-3s, "Keldysh's boys" established that the latter could achieve the necessary velocity of 7,500 meters per second, close to orbital velocity. Subsequently, the men examined different configurations of packets in detail, including those with so-called "feeding packets," whereby propellants would pour from tank to tank, and those consisting of independent tanks. In their synopsis, the authors concluded that a simple packet would indeed be the most efficient path of development, given the relatively minimal modifications required of an already existing "standard" missile such as the R-3. The development of such elements as guidance systems, the authors predicted, would be an easier proposition. While the report was mostly exploratory in nature, the scientists clearly stated that the most favored variant for an ICBM would be a two-stage missile using two strap-on boosters in the simple packet configuration, each based on the R-3, whose mass happened to be practically identical to more sophisticated configurations.¹¹³

111. Kantemirov, "15 July—40 Years From the Report "

112. Golovanov, *Korolev*, pp. 468–69. Apart from the OKB-I, the OPM MIAN, and the NII-4, other organizations involved in the N3 theme were OKB-456 (V. P. Clushko), NII-885 (M. S. Ryazanskiy and N. A. Pilyugin), NII-3 (V. K. Shebanin), TsIAM (G. P. Svrshchev), TsAGI (A. A. Dorodnitsyn and V. V. Struminskiy), NII-6 (V. A. Sukhikh), NII-125 (B. P. Zhukov), NII-137 (V. A. Kostrov), NII-504 (S. I. Karpov), NII-10 (V. I. Kuznetsov), and NII-49 (A. I. Charin). See Semenov, ed., *Raketno-Kosmicheskaya Korporatsiya*, p. 73.

113. The complete report is reproduced in Avduyevskiy and Eneyev, eds., *M. V. Keldysh*, pp. 39–142. See also Yatsunskiy, "On the Activities of M. K. Tikhonravov."

The N3 studies carried out at Korolev's own OKB-I proved to have essentially similar results. On December 27, 1951, he formally presented the preliminary conclusions of the effort to the Scientific-Technical Council of NII-88 as part of a report titled "Thesis Report on the Results of the Investigation of Prospective Development of a Long-Range Ballistic Missile."¹¹⁴ The scope of the investigation was extremely wide, and engineers at OKB-I explored a variety of different concepts, including single-stage and two-stage missiles. The latter included looking at tandem designs, strap-on or packet designs with the engines all firing simultaneously or sequentially, and feeding packets. They also studied missiles using multichamber engines, a first for Korolev's team, underlining an interest that would eventually play a major role in determining the final look of the ICBM. Ballistics and performance characteristics of each missile were examined in detail in the report. In making his presentation in December 1951, Korolev was able to note that his engineers had compared the flight characteristics of six specific missile designs (Table I).

The first design would require a very powerful engine, while the second used fluorine-based technology, both of which eliminated them as serious contenders for further research. The third option, a conventional tandem two-stage design, was also excluded from further research because it would require a second-stage engine capable of firing in a vacuum. Each of the three packet variants consisted of a core and two strap-ons. The generic packet had the strap-ons firing at liftoff, with the core igniting at altitude after strap-on propellant depletion. In the load-bearing packet, all the engines on the strap-ons and the core fired at liftoff. In the final configuration, propellants would be supplied to the core from tanks on the strap-ons. At altitude, the strap-ons would be jettisoned, leaving the core to fire as a single unit.¹¹⁵

Table I. ICBM Design Flight Characteristics

Type	Range (km)	Length	Mass (t)	Stage I Thrust (t)	Stage II Thrust (t)
1. Single-stage using LOX	5,000-7,000	46	325	500 (sl)	—
2. Single-stage using fluorine-based oxidizer	7,000		70		—
3. Two-stage tandem	7,000	39.7	110	170 (sl)	30 (v)
4. Two-stage packet	7,000	17.4	121	2 x 93 (sl)	38 (v)
5. Two-stage packet with load-bearing tanks	7,000	16.5	128	2 x 115 (sl) 1 x 34 (sl)	42 (v)
6. Two-stage packet with propellant feeding	7,000	16.5	117	2 x 70 (sl) 1 x 40 (sl)	50 (v)

¹¹⁴ The report is reproduced in Keldysh ed *Tvorcheskoye naslediyе akademika Sergeya Pavlovicha Koroleva* pp 319-27

¹¹⁵ *Ibid*

The fifth variant—a central booster with a thirty-four-ton-thrust engine combined with two strap-ons, each having a sea-level thrust of 115 tons—apparently had been the early favorite, primarily because it was literally the simplest packet configuration. A final recommendation was left to the future, apparently because of the uncertainty concerning engine development. Korolev cautioned in his report. "It must be noted that these investigations of ballistic and long-range missiles may only serve as a basis for the establishment of primary directions to be followed by detailed elaborations of definite projects and proposals."¹¹⁶

One of the notable aspects of NII-88's work on the N3 theme that distinguished it from OPM MIAN's work was over the R-3. By the end of 1951, the R-3 program was in deep trouble, and this was clearly reflected in Korolev's work on the N3 theme. Perhaps realizing that the ambitious R-3 might be too large a step to successfully overcome, Korolev's engineers used relatively smaller boosters as components of potential clustered missiles. OPM MIAN's work, on the other hand, used the R-3, although in some cases they studied packaging five boosters into one ICBM. As the N3 theme was winding down, Korolev and his deputies combined elements from both analyses—that is, they derived a new preliminary concept of an ICBM that had a core and four strap-ons instead of two. Instead of the R-3 as the basis for all the boosters, they introduced much smaller boosters, each having engines with thrusts in the range of fifty to sixty tons each. Ballistics analysis clearly showed that with less powerful strap-ons but with a higher number of them, a missile could have the same if not better characteristics than that of an R-3-based rocket. The use of less powerful engines would also eliminate the bottleneck problems of developing 120-ton-thrust engines such as the one for the R-3. As a result, Korolev's First Deputy Vasily P. Mishin, in consultation with a leading manager at the Ministry of Armaments, emerged with a revised plan for future Soviet development: terminate all work on the R-3 and proceed immediately to the creation of a new ICBM.¹¹⁷

Like the R-3 proposal itself, the idea to jump from the R-3 directly to the ICBM was uncharacteristic of Soviet military practices because it necessitated a huge qualitative and quantitative leap in abilities. Officials in the Ministry of Armed Forces were, not surprisingly, resistant to the proposal. They had great hopes for the R-3 as the first Soviet strategic missile capable of hitting targets deep into Europe. Despite overwhelming resistance, Mishin managed to convince Korolev that NII-88 should proceed directly to the ICBM instead of wasting more time on the R-3. Korolev, after "some doubts," finally agreed. Korolev and Mishin had two prominent supporters in the government: Minister of Armaments Dmitriy F. Ustinov and his Deputy Ivan G. Zubovich.¹¹⁸ Despite a formidable array of doubters, Ustinov, Zubovich, and Korolev were able to persuade leading officials in the armed forces, in particular Col. General Nedelin, the armed forces' chief person for managing the procurement of new ballistic missiles, of the change in strategy. After "some hesitancy," Special Committee No. 2 adopted Korolev's proposal. Work on the R-3 program was abandoned in 1952.

The N3 theme not only encompassed the development of ballistic missiles, but also intercontinental cruise missiles, known by Soviet engineers as "winged missiles." By 1952, there was still no firm consensus on whether ballistic or cruise missiles would offer a more efficient mode of delivering nuclear weapons across intercontinental distances. Each variant had its own disadvantages and advantages, which were the subject of intense scrutiny during the N3

¹¹⁶ *Ibid.*, p. 327. Stache, *Soviet Rockets*, p. 287

¹¹⁷ Biryukov and Yermenko, "50 Years for the Native Rocket-Space Industry". Biryukov, "The R-3 Rocket Project Developed in the U S S R "; V. P. Mishin, "Problems of the First Flight of a Man into Space" (English title), in *Çagarinskiye nauchnyye chteniya po kosmonavtike i aviatsii* (Moscow: Nauka, 1991), p. 22; Romanov, *Korolev*, pp. 373-74. The official at the Ministry of Armaments was A. V. Zaytsev, an employee of the Seventh Chief Directorate

¹¹⁸ Mishin, "Problems of the First Flight," p. 22.

research phase. In the case of cruise missiles, the less stringent requirements for structural elements and power plants for cruise missiles and the extensive experience in aircraft construction prompted a serious look into a competitor program for the ICBM. Dedicated research on the issue had commenced on October 30, 1950, at NII-88.¹¹⁹ Like the ballistic missile, Korolev had settled on a two-stage configuration. Unlike the former, however, the cruise missile was to use a traditional rocket engine on the first stage and a supersonic ramjet engine on the winged second stage. The latter had an advantage over traditional rocket engines by having a simpler technical construction and decreased mass, although it only operated within certain altitudes and velocities. Like concurrent American designs, such as the Navaho XSM-64 cruise missile, the Soviet vehicle was designed to travel its entire flight in the atmosphere, using the atmosphere itself as its oxidizer.

Korolev personally summarized NII-88's research on intercontinental cruise missiles as part of the N3 theme at a meeting of the Scientific-Technical Council of the institute on January 16, 1952, about two weeks following the similar presentation on ICBMs. The report, titled "Thesis Report on the Results of Research on the Prospects of Developing a Long-Range Winged Missile," comprised detailed analysis to determine the optimal configuration for a cruise missile.¹²⁰ Korolev's engineers believed that the best design would be a two-stage cruise missile with a mass of about ninety to 120 tons and a range of 8,000 kilometers. The first stage would accelerate the second stage to an altitude of fifteen to twenty kilometers and a velocity of 900 meters per second—that is, in the window for ignition of the ramjet engines. The second stage would then fly at about Mach 3 in horizontal fashion to its target and deposit its warhead. As with the ICBM conceptions, one of the primary problems was developing sufficiently powerful liquid-propellant rocket engines for the first stage. NII-88's analysis indicated that engines with thrusts on the order of 100 to 165 tons would be required. Ramjet engine thrusts would be limited to eight to ten tons. Engineers also examined three different launch configurations for the cruise missile: horizontal launch, air launch, and vertical launch. Given time and technological limitations, the last configuration proved to be the best option.

Given the leap in technology required to build an intercontinental cruise missile, Korolev proposed the development of an intermediate vehicle, the Experimental Winged Missile (EKR), a two-stage vehicle with an overall mass of just under six tons. The missile would have a flight range of a modest 900 to 1,300 kilometers. To reduce the time of development, engineers elected to maximize already tested hardware on the vehicle. For example, the main engine of the first stage would be the S2.253 engine from the short-range R-11 tactical missile. The thrust was just under eight tons. The second stage would use a single ramjet engine with a thrust of more than three tons.¹²¹ The development of this particular engine benefited greatly from the considerable amount of research expended over the abandoned Sanger-Bredt proposal, as well as subsequent conceptions of intercontinental cruise missiles proposed at Keldysh's department at the Central Institute of Aviation Motor Building. The expansion of this department's role in the development of intercontinental cruise missiles prompted aviation industry officials to detach it from TsIAM and reestablish the old NII-1 as a separate entity on March 10, 1952.

119 Biryukov. "Materials in the Biographical Chronicles," p. 230.

120 An edited version of the report has been published as S. P. Korolev, et al., "Thesis Report on the Results of Research on the Prospects of Developing a Long-Range Winged Missile" (English title), in Keldysh, ed., *Tuorcheskoye naslediyе akademika Sergeya Paulouicha Koroleva*, pp. 328-41.

121. These data are taken from Korolev, et al., "Thesis Report on the Results of Research." Other conflicting data on the EKR are given in Semenov, ed., *Raketno-Kosmicheskaya Korporatsiya*, pp. 61-62. The latter may refer to a later version of the EKR with a flight range of 730 kilometers, a first-stage thrust of more than eight tons, and a second-stage thrust of 625 kilograms (at an altitude of eighteen kilometers and Mach 3). See also I. Afanasyev, "Without the Secret 'Stamp': Halt the Work. Destroy the Materials" (English title), *Aviatsiya i kosmonautika* no. 6 (June 1993) 42-44.

with Keldysh as its director. The focus on ramjet engines was also underscored by the establishment of the new OKB-670 in 1950 under Chief Designer Mark M. Bondaryuk, a former department head at NII-1, whose team had been conducting research to build the Sanger-Bredt ramjet. For Korolev's EKR, Bondaryuk was contracted to build the RD-040 ramjet." Work on the EKR culminated with the signing of a five-volume draft plan for the vehicle on January 31, 1953, by Korolev, Keldysh, Bondaryuk, and Sergey A. Khristianovich, the Deputy Director of TsAGI, who was one of the leading aeronautical scientists in the Soviet Union."

The complete work on the N3 theme was collated into a three-volume set published in 1952. The results indicated the most prospective directions for further research on the development of an intercontinental missile. Both industrial officials and engineers such as Korolev were unwilling to come out in favor of a ballistic approach as compared to a cruise missile option. There were intense discussions in late 1952 at various levels, within Special Committee No. 2, the Ministry of Armaments, the Ministry of Aviation Industries, NII-88, and NII-1. Among other things, an ICBM would require the development of a new heat shield for its warhead to protect it during atmospheric reentry. In addition, engineers would have to design a complex guidance and control system to accurately control the trajectory of the missile. On the other hand, with a cruise missile, one of the most challenging tasks would be the development of a star-sensing navigation system capable of operation during both day and night. The ICBM had the advantage of being invulnerable to defensive measures because it would be flying at altitudes of approximately 1,000 kilometers and speeds of almost 25,000 kilometers per hour. The cruise missile would, however, fly for several hours before reaching its target, at a relatively low altitude, making it vulnerable to defensive measures. Ultimately, the Soviet government opted to pursue both options, at least for the time, clearly hoping to mitigate the risk of failure if only one variant was pursued. Stalin himself took a personal interest in the matter. On February 13, 1953, less than a month prior to his death, he signed an official USSR Council of Ministers' decree that affected work on all long-range ballistic and cruise missiles in the Soviet Union. The decision officially:

- Terminated work on the R-3 missile
- Stipulated a timetable for testing the R-5 strategic missile
- Terminated work on the N1, N2, and N3 themes
- Approved two new themes—the T1 and T2

The T1 theme, called "Theoretical and Experimental Research on the Creation of a Two-Stage Ballistic Missile with a Range of 7–8 Thousand Kilometers," formally approved the development of a blueprint for a Soviet ICBM based on prior research. The T2 theme officially sanctioned initial groundwork for the creation of an intercontinental cruise missile—that is, it gave full approval to build the EKR to prove out new technologies for the program. The prime contractor for both vehicles would be Korolev's OKB-1 at NII-88 based in Kaliningrad." The

122. Yevgeniy Yerokhin, "The Missiles of Bondaryuk" (English title), *Krylia rodiny* no. 11 (November 1993), 33–37. OKB-670 traced its lineage back to EKB-1 of NII GVF established in 1940. EKB-1 was absorbed by NII-1 in 1944. Bondaryuk was appointed Chief Designer of a department at NII-1 on August 30, 1947. This department became the Independent OKB-670 in 1950. OKB-670 also concurrently worked on ramjet engines for other missiles and aircraft, such as the R-1 Shtorm and the Samolet 5.

123. Semenov, ed., *Raketno-Kosmicheskaya Korporatsiya*, p. 61.

124. German Nazarov, "You Cannot Paper Space With Rubles: How to Save Billions" (English title), *Molodaya gvardiya* no. 4 (April 1990), 192–207; Colovanov, "The Beginning of the Space Era", Semenov, ed., *Raketno-Kosmicheskaya Korporatsiya*, pp. 73, 630; Romanov, Korolev, p. 266. For a general description of the themes T1 and T2, see Mozzhorin, et al., eds., *Nachalo kosmicheskoy ery*, pp. 71, 262. The February 1953 decree also affected other missile programs. It approved the development of the short-range R-11 missile and approved the transfer of work on a new missile, the R-12, from NII-88's OKB-1 to SKB-586 based in Dnepropetrovsk, Ukraine.

detailed design parameters and configuration of both rockets would be determined in the course of the ensuing two years.

By the time that the T1 theme began in February 1953, Korolev's engineers had sharpened their conception of the ICBM to fit specific requirements.¹²⁵ The missile would be a two-stage vehicle—that is, a core with strap-ons—capable of delivering a three-ton warhead to a distance of 7,000 to 8,000 kilometers. Overall launch mass and launch thrust would be 190 tons and 270 tons, respectively. The design had a direct link to the most preferred variant that had emerged from the N3 studies between 1950 and 1953, but it was optimized to fit less powerful engines and more strap-ons. The ICBM was to become a five-booster clustered missile with a central sustainer (called "Blok A") and four strap-on boosters (Blocs B, V, G, and D). All engines would fire simultaneously at liftoff; they would be separated at altitude, leaving the central one, serving as the second stage, firing until final cutoff. Each of the boosters would be equipped with one single-chamber LOX-kerosene engine with a thrust of about fifty to sixty tons. Apart from the number of strap-ons and the power of the engines, a third major design change from 1952 to 1953 was the shape of each booster. The configuration of the ICBM in the original N3 studies owed much to the shape of the abandoned R-3 missile, which was a classically constructed sleek cylinder. The new design incorporated tapered boosters, similar to elongated cones and superficially similar to the German A-4. Engineers at OKB-1 evidently gravitated to a conical shape for the strap-ons primarily because of the aerodynamic advantages over a standard cylindrical design. Furthermore, the size of the engines, the possibility of imparting additional thrust to the central sustainer, and the opportunity of decreasing tank wall thickness eventually prompted the engineers to drop the classic cylinder design.¹²⁶ The end result was four conical-shaped boosters attached to a central element, which widened in its diameter to meet the apexes of each of the four cones. It was a decision that froze the configuration of what would eventually become the world's most used launch vehicle, a design that remains instantly recognizable today.

Based on the N3 studies, Korolev's engineers had explored the possibility of incorporating the capability of propellant transfer between the strap-on blocks, especially in cases of failure in one or more boosters, but they rejected this design based on added complexities from the need for hydraulic connections between each strap-on. Instead, OKB-1 developed the System for Synchronization and Simultaneous Emptying of Tanks to ensure that propellant flow from all the boosters was regulated on a common timeline. Guidance for the ICBM would be effected by aerodynamic rudders and gas vanes placed in the engine outflow, a throwback to the pre-R-3 days.¹²⁷

This first order of business for work on the new ICBM, called the R-6, was the engines. Korolev approached Chief Designer Glushko for the job, but he ran headlong into conflict. As one Russian historian wrote:

Glushko refused. He was bothered first of all by the fact that Korolev was violating the boundaries of his own professional competence. Glushko felt that he himself knew what kind of engines the new rocket needed. The kind of engines that Korolev was talking about had not been produced yet. Glushko was afraid of explosive detonations and

¹²⁵ The senior engineers at NII 88 s OKB 1 who worked on the N3 and T1 themes included R. F. Appazov, K. D. Bushuyev, B. Ye. Chertok, V. F. Gladkiy, Ya. P. Kolyako, S. S. Kryukov, A. F. Kulyabin, S. S. Lavrov, V. P. Mishin, I. S. Prudnikov, V. F. Roshchin, Ye. F. Ryazanov, I. N. Sadovskiy, P. F. Shulg'in, G. S. Vetrov, P. I. Yermolayev, and P. A. Yershov. See Semenov, ed., *Raketno-Kosmicheskaya Korporatsiya*, p. 73.

¹²⁶ Timothy Varfolomeyev, "Soviet Rocketry," *Spaceflight* 37 (December 1995): 411. There were also several disadvantages to the conical design, which are outlined in the same source.

¹²⁷ Mishin, "Problems of the First Flight," pp. 20-21.

acoustic vibrations—the probability of their occurrence increasing with the size of the combustion chamber. But *even if he would* have succeeded in producing such a [liquid oxygen] engine, he didn't have the necessary test rigs on which he could test it.'"

Under severe pressure from not only Korolev, but other chief designers, Glushko eventually agreed. In 1952, his design bureau, OKB-456, began developing two new LOX-kerosene engines, the RD-105 and the RD-106. Both designs used Chief Designer Isayev's idea of the integrated solder-welded configuration, which had opened the door to more powerful single-chamber LOX engines. The RD-105, with a thrust of fifty-five tons, was intended as propulsion for each of the four strap-ons of the ICBM, while the RD-106, with a thrust of fifty-three tons (65.8 tons in a vacuum), was earmarked for the central block."

The initiation of work on the T1 and T2 themes in 1953 was an indication of a remarkable maturity in the Soviet long-range missile programs. From the modest beginnings of the 300-kilometer-range R-1 in 1948, within five years, the Soviets were moving headlong into producing weapons with ranges of 8,000 kilometers. The rate of progress was tremendous, characterized more by technological leaps in capability, contradicting the traditional Western view of Soviet technology advancing incrementally over decades. Driven by strong personalities such as Korolev and Ustinov, the missile program also benefited from strong military support. By the mid-1950s, Korolev would have yet one more major factor on his side: institutional disarray in the rocketry effort, which allowed him to take advantage of loopholes to divert a portion of the ICBM program to his own ends

Korolev and the Party

When Stalin died in March 1953, it instigated the first change of leadership in the Soviet Union in more than thirty years. It seems that the major thrust of the rocketry program changed little as the succession to Stalin stabilized over the next few months. There is evidence, however, to suggest that his successors had a less-than-clear understanding of the missile industry, especially in areas of policy, no doubt because the leadership of NII-88 had reported directly to Stalin, often bypassing high Communist Party officials. Even Politburo member Georgiy M. Malenkov, appointed the chairman of the Special Committee No. 2 in 1946, was apparently uninvolved with details of the rocketry program.¹²⁹ The management of the project remained firmly in the grip of the Soviet intelligence services under the dreaded Beriya, who proliferated his henchmen in all layers of the Ministry of Armaments and the Council of Ministers. Policy decisions adopted by Beriya or Stalin himself eventually trickled down via secret police operatives before Minister of Armaments Ustinov, under the watchful eye of Beriya, would tackle the task of managing personnel and activities at the various institutes, design bureaus, and manufacturing plants.

While Ustinov was in general "a Party man," it seems that he was very protective of engineers such as Korolev and Glushko in cases in which Beriya's people became too threatening. For example, during the overtly anti-Semitic drive to arrest intellectuals in the last years of Stalin's life, several Jewish engineers in the rocketry program found their lives in jeopardy. One night, Ustinov telephoned Chief Designer Ryazanskiy and asked him to go for a walk with him in a nearby park. Realizing the absurdity of such a request from a minister, Ryazanskiy was

128 Golovanov, Korolev, p. 709.

129 Timothy Varfolomeyev, "Soviet Rocketry that Conquered Space. Part I: From First ICBM to Sputnik Launcher." *Spaceflight* 37 (August 1995) 260–63; Prishchepa. "From the History of the Creation." p. 123; Prishchepa. "History of Development of First Space Rocket Engines." p. 99

130. Golovanov, Korolev, p. 394

quick to pick up that something was amiss. During the walk, Ustinov asked Ryazanskiy to immediately send his Deputy Yevgeniy Ya. Boguslavskiy on a trip "anywhere."¹³¹ When Ryazanskiy objected to such an unusual order, Ustinov categorically demanded that Boguslavskiy be immediately sent away on a new mission. Ryazanskiy carried out the order, possibly saving his deputy from being a victim of Beriya's anti-Semitic pogrom. On another occasion in 1950, realizing that Beriya was targeting Jewish engineers at NII-88, Ustinov demoted talented control systems engineer Boris Ye. Chertok to deflect attention away from him and thus preclude his arrest.¹³²

Upon Stalin's death, as Politburo members jockeyed to assume their niches of power, it was clear that the only ones who had significant knowledge of the rocketry program were the middle managers, such as Ustinov and Vetoshkin, and of course the secret police. Thus, the upper echelons in the government were, by some accounts, bewildered to discover a vast institutional apparatus for the development of ballistic missiles. An account from Politburo member Nikita S. Khrushchev provides a hint of the new leadership's problems:

... while Stalin was alive he completely monopolized all decisions about our defenses, including — I'd even say especially those involving nuclear weapons and their delivery systems. We were sometimes present when such matters were discussed, but weren't allowed to ask questions. Therefore when Stalin died, we weren't really prepared to carry the burden on our shoulders. Our experience with Korolev is a case in point."

In the weeks following Stalin's death, four major players emerged in the struggle to take over the leadership of the country: Beriya, Khrushchev, Malenkov, and Nikolay A. Bulganin, the newly appointed Minister of Armed Forces. Beriya, with the initial support of Malenkov, consolidated his already immense power by combining the two national security services into one entity, the Ministry of Internal Affairs. Having effectively assumed personal control over all high-technology programs in the country, his reign lasted only weeks, and Khrushchev, with the support of high military leaders, eventually had him arrested on June 26, 1953.¹³³ Following a quick trial later in the year, Beriya was summarily executed by gunshot on December 23. His arrest precipitated the first thaws in the indiscriminate terror that had pervaded Soviet society since the formation of the USSR nearly forty years before.

The confusion in the post-Stalin months prompted a major restructuring of advanced technology industry such as nuclear and rocket weapons. Despite Beriya's elimination from the scene, many of the managers of the nuclear weapons industry who had served under him, by default, ended up inheriting major roles in the rocketry program. The process was set off on July 1, 1953—five days after Beriya's arrest—when the Presidium (later the Politburo) created the new Ministry of Medium Machine Building based on the top-secret First Chief Directorate of the USSR Council of Ministers, the same entity that had managed the atomic weapons program since 1946 under Beriya's watchful eye. Vyacheslav A. Malyshev, a fifty-one-year-old former railroad engineer, well known for his role in managing the production of tanks during the war, was appointed to head the ministry. Unlike other ministers in the Soviet government, however,

¹³¹ *Ibid* p 439 Col M Rebrov. "The Whiteness of Martian Seas Pages From the Life of the Chief Designer of Radio Control Devices" (English title) *Krasnaya zvezda* March 11, 1989 p 4

¹³² Instead of Boris Chertok, Minister Ustinov appointed Mikhail K Yangel as head of the department because Yangel was a long-time member of the Communist Party

¹³³ Nikita S Khrushchev. *Khrushchev Remembers The Last Testament* (Boston Little & Brown 1974) pp 45-46

¹³⁴ Holloway *Stalin and the Bomb* p 320

Malyshev was also appointed a deputy chairman of the Council of Ministers." A man aligned with the Malenkov axis in the Presidium. Malyshev was an extremely professional and intelligent individual who worked closely with Beriya on nuclear weapons development during the postwar years. As the top manager of the Soviet defense industry, Malyshev's appointment effectively made him the most influential arbiter of defense sector management at the time.

As head of the new ministry, Malyshev was responsible for the management of all three major top-secret weapons development programs in the Soviet Union: the atomic bomb, the air defense weapons, and the ballistic missile programs. The first two of these had been operated via three "Chief Directorates" of the Council of Ministers reporting directly to Beriya. With the formation of the Ministry of Medium Machine Building, the First (for atomic weapons), the Second (for management of the raw material base for the uranium industry), and the Third (for air defense missiles) were united into one and subsumed under this one ministry.¹³⁶ The precise fate of the mysterious Special Committee No. 2, which had directed the ballistic missile program, is not clear—it may have been disbanded as early as 1949—but there is no doubt that the new Ministry of Medium Machine Building also had final oversight over the missile effort after 1953. Management of day-to-day activities remained under the purview of Ustinov at the Ministry of Armaments.¹³⁷

Malyshev was not a big supporter of Korolev. Unlike Ustinov, who may have listened with one ear to Korolev's interests in space exploration, Malyshev was a tried-and-true administrator whose only goal was to produce weapons efficiently. There were, in fact, several occasions when Korolev and Malyshev went head to head. One Russian space historian, Aleksandr P. Romanov, pieced together a perhaps apocryphal account of a spat between Korolev and Malyshev over the R-3. At a high-level meeting to discuss the missile, Korolev almost casually announced to the attendees that work on the R-3 should be terminated immediately to concentrate forces on going

¹³⁵ John McDonnell, "The Soviet Defense Industry as a Pressure Group" in Michael McGwire, Ken Booth and John McDonnell, eds., *Soviet Naval Policy: Objectives and Constraints* (Halifax, NS: Centre for Foreign Policy Studies, 1975), p. 88. A more recent Russian source suggests that the order for the formation of the Ministry of Medium Machine Building was actually issued on April 2, 1953, more than two months before Beriya's arrest. See N. S. Simonov, *Voyenno-promyshlennyy kompleks SSSR v 1920–1950 ye gody: tempy ekonomicheskogo rosta i struktura organizatsiya proizvodstva i upravleniye* (Moscow: ROSSPEN, 1996), p. 246.

¹³⁶ Simonov, *Voyenno-promyshlennyy kompleks SSSR v 1920–1950 ye gody*, p. 246. See also Andrey Sakharov, *Memoirs* (New York: Alfred A. Knopf, 1990), p. 169; Grigoriy Kisunko, *Sekret'naya zona* (Moscow: Sovremennik, 1996), p. 267. The First Chief Directorate had been established on August 20, 1945 (headed by B. L. Vannikov), the Second on December 27, 1949 (headed by V. Ya. Antropov), and the Third on February 3, 1951 (headed by V. M. Ryab-kov). See Simonov, *Voyenno-promyshlennyy kompleks SSSR v 1920–1950 ye gody*, pp. 216–225, 236. A few sources have incorrectly continued to claim that the Second Chief Directorate was a successor to the Special Committee No. 2—that is, it also oversaw the ballistic missile sector. See Vladislav Zubok and Constantine Pleshakov, *Inside The Kremlin's Cold War: From Stalin to Khrushchev* (Cambridge, MA: Harvard University Press, 1996), p. 172; B. Ye. Chertok, *Rakety i lyudi: goryachiye dni kholodnoy voyny* (Moscow: Mashinostroyeniye, 1997), p. 19; Golovanov, *Korolev*, p. 454.

¹³⁷ There is some evidence to make an institutional connection between the old Special Committee No. 2, which had overseen policy aspects of the ballistic missile program from 1946, and the new Ministry of Medium Machine Building via a third government entity. This was the Third Chief Directorate of the USSR Council of Ministers established on February 3, 1951, under the leadership of V. M. Ryab-kov (who until then had been D. F. Ustinov's deputy in the Ministry of Armaments). This directorate's primary duties were to oversee all research and development work on Soviet anti-aircraft and air defense missiles. When the new Ministry of Medium Machine Building was established on July 1, 1953, the Third Chief Directorate was subordinated to the ministry and renamed the Chief Directorate of Special Machine Building (GlavSpetsMash). Ryab-kov remained the chief of GlavSpetsMash with the dual rank of Deputy Minister. Less than a month later, on July 29, 1953, an official governmental decree moved all ballistic missile work to the jurisdiction of GlavSpetsMash—that is, within the Ministry of Medium Machine Building under Ryab-kov (Deputy Minister) and Malyshev (Minister). See Arkadiy Kruglov, *Shtab atomproma* (Moscow: TsNIIatominform, 1998), pp. 103–106; Irina Bystrova, "The formation of the Soviet Military Industrial Complex," Center for International Security and Arms Control, Stanford University, September 1996, p. 13.

directly to an ICBM. When Korolev finished, Malyshev looked at Korolev in bewilderment, unable to believe that the chief designer would dare to propose cancellation of a missile that was crucial to the needs of the Soviet armed forces for the next few years. When some attendees accused Korolev of using the ICBM program as a means to advance his ideas of space exploration, the chief designer did not back down, pleading that what was needed was a technological leap rather than an incremental advance. Malyshev, true to his character, severely berated Korolev in front of everyone, telling him that his proposal was out of the question. Visibly agitated, Korolev blurted out, "I refuse. Vyecheslav Aleksandrovich [Malyshev]. I repeat: this is an ant[-state approach to this matter." Malyshev, not one for being intimidated, replied, "No! Really? He refuses? . . . People are not irreplaceable. Others can be found."¹³⁸ With this implicit threat on Korolev's position, there was a long moment of silence. Malyshev abruptly adjourned the meeting, saying that any more discussion on the issue was useless.

R-3, of course, was canceled just as Korolev had proposed. There is no record to suggest why Malyshev eventually capitulated. Perhaps Ustinov played a key role in convincing Malyshev's boss Malenkov. Certainly Beriya's

arrest may have prompted Korolev to take risks he might not have previously. Clearly, however, 1953 was a pivotal year in Korolev's life. Both Stalin's and Beriya's departures had profound effects on the activities of Soviet scientists. Although formal rehabilitation for Korolev's alleged crimes in the 1930s had yet to occur, the persistently dark cloud of unexpected terror had begun to move away, and this had a marked result on his mood. Still, given the institutional arrangements of a totalitarian system, the mind-set of the Beriya years took a long time to evaporate. The history of Korolev's incarceration, in fact, significantly affected his acquirement of power in the ballistic missile program, as Communist Party officials continued to refrain from supporting an individual who was still officially a criminal of the state. With this handicap, Korolev was often forced to watch while less experienced engineers leapfrogged ahead.

One particularly important event in this respect was the rise of a talented aeronautical engineer by the name of Mikhail Kuzmich Yangel, who would go on to become the preeminent designer of strategic ballistic missiles in the Soviet Union. Born in the Ukraine on October 25, 1911, Yangel had served his apprenticeship in several major wartime aeronautical organizations led by famous designers such as Polikarpov, Mikoyan, and Myasishchev. Someone in the "higher leadership" had apparently been impressed with Yangel's activities at the Academy of

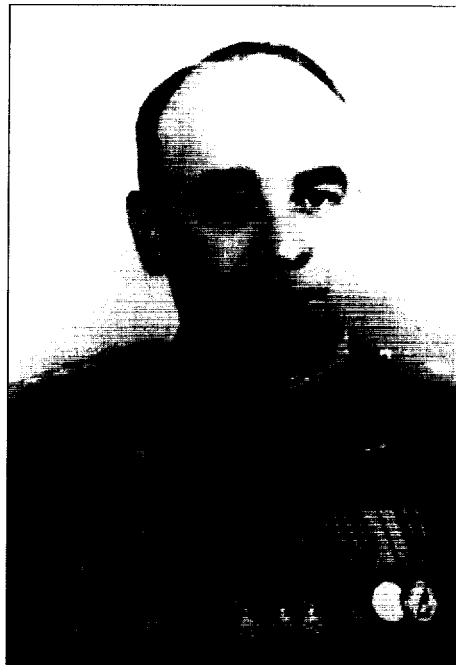

Vyecheslav Malyshev, shown here in the early 1950s, was the first manager of the entire Soviet military-industrial complex. From 1953 to 1955, as Minister of Medium Machine Building, he oversaw the rise of the hydrogen bomb and ICBM programs (copyright Steven Zaloga)

¹³⁸ Romanov Korolev pp 239-40. There is one major flaw in this account sufficient to cast doubt on the entire anecdote. Malyshev did not become Minister of Medium Machine Building until July 1953, while the R-3 program was officially terminated in February 1953. Prior to July 1953, Malyshev had no connection whatsoever with the ballistic missile program.

Aviation Industry in the late 1940s, recommending him to Ustinov for a big promotion into NII-88. Despite Yangel's apparent lack of expertise in the area of guidance systems, in April 1950, Ustinov appointed Yangel chief of Department No. 5, the sector responsible for the development of guidance systems at the institute.¹³⁹ Yangel was a strict Party man, having joined in the early 1930s, and combined with his great technical prowess, within a year, he advanced to the post of Deputy Chief Designer at OKB-1 under Korolev.

When NII-88 Director Rudnev was unexpectedly promoted to become a Deputy Minister of Armaments under Ustinov in May 1952, Party officials conducted a search for a suitable candidate to serve as head of the institute. It came as somewhat of a shock to most engineers when they were told that Yangel, and not Korolev, would assume the role as the director of NII-88. Clearly, Yangel's Party credentials were a significant factor in the new appointment, and Korolev was put in the awkward

position of having to report to an individual who had been a subordinate for the previous two years. Both individuals had very strong personalities, and their relationship with each

other was far from smooth, resulting in a very strained and stressful working environment at the institute. They essentially avoided speaking to each other, and Korolev would often use his deputies, such as Mishin or Chertok, as intermediaries.¹⁴⁰ The stress was apparently too much, and on October 4, 1953, Yangel was demoted to the position of Chief Engineer of NII-88.¹⁴¹ Although still officially superior to Korolev, Yangel was henceforth primarily involved in the production of missiles at the manufacturing plant in Dnepropetrovsk.

The conflict between Korolev and Yangel also served to set the stage for the formation of a new organization, only the second apart from NII-88 dedicated to the development of long-range ballistic missiles. The State Union Plant No. 586 at Dnepropetrovsk had originally been involved in the manufacture of older missiles, such as the R-1 and the R-2, directed by Korolev's former protege, Chief Designer Budnik. Although the plant primarily handled production, Korolev let Budnik set up a small design department, officially subordinate to the former, to explore modifying existing missiles. The work resulted in the development of an improved R-1 named the R-1M, distinguished by its new guidance system. At the same time, Budnik, jointly with engineers at NII-88, set about on a more ambitious project to define the concept for a new

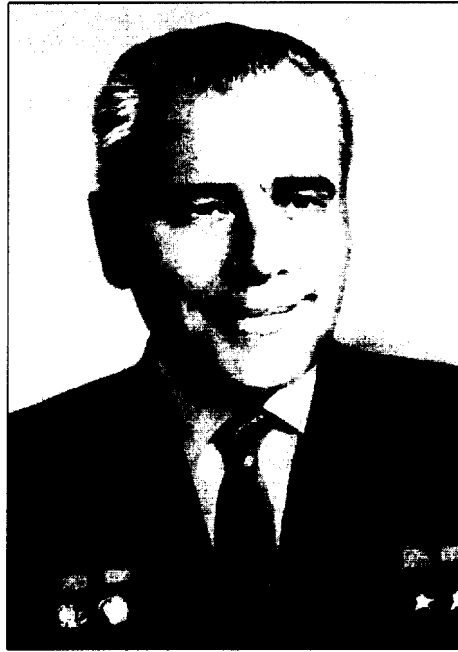

This photo of Chief Designer Mikhail Yangel is from the mid 1960s. Although he started his career under Korolev, Yangel eventually headed an independent missile design organization in Dnepropetrovsk in the Ukraine, which produced some of the most important ICBMs in the Soviet arsenal (files of Peter Gorin)

139. Golovanov, Korolev, p. 439, Lardier, *L'Astronautique Soviétique*, p. 95, Chertok, *Rakety i lyudi*, p. 353

140. Chertok, *Rakety i lyudi*, p. 354-355; Golovanov, Korolev, p. 440

141. Jacques Villain, ed., *Baïkonour la portedes étoiles* (Paris: Armand Colin, 1994), p. 136, Chertok, *Rakety i lyudi*, p. 355. Maj General A. S. Spiridinov, who had served as liaison officer with the Germans at Gorodomylya, was appointed the new director of NII-88 at the time. A. A. Yeremenko, Chief of the Public Affairs Department of TsNIIMash, letter to the author, April 14, 1994

strategic ballistic missile named the R-12, or "product 8A63," which would use storable propellants, have an autonomous guidance system, and be capable of a range of about 2,000 kilometers. The military was evidently interested in a missile that would have the modern design characteristics of the R-5 but be as easy to store for long periods as the short-range tactical R-11. Budnik was lucky to have a collaborator: Chief Designer Dominik D. Sevruc at NII-88's OKB-3 had by this time begun work on high-thrust engines using red fuming nitric acid and kerosene (storable components). Both Korolev and Clushko were lukewarm at best to the whole idea of the R-12, but on the insistence of the military, they began to take it seriously.¹⁴² On February 13, 1953, in the same decree sanctioning the ICBM's development, the Soviet government formally transferred all draft plan work on the R-12 from NII-88 to Budnik's command in the Ukraine.¹⁴³

Because Budnik's design bureau was essentially an entity focused on manufacturing, however, it faced serious problems in funding and staffing.¹⁴⁴ The problems at the factory opened the way for a solution to the conflict between Korolev and Yangel. In early 1954, Khrushchev instructed Minister Ustinov to draw up a plan to dilute Korolev's absolute monopoly in the rocket-building business. Ustinov emerged with a plan to create two completely independent groups, one in the Ukraine and one in the Urals. Korolev was called to a meeting to meet Khrushchev, who was then the First Secretary of the Communist Party, to discuss the issue. Korolev was naturally very resistant to competitors, and he suggested to Khrushchev that the most optimum plan would be to have centrally located design bureaus in the Moscow area and a number of branches spread across the Soviet Union. Khrushchev was adamantly opposed, instead arguing that the two new groups would be completely independent from OKB-1.¹⁴⁵ Thus, Korolev finally ceded his monopoly, and the foundation was laid for the expansion of the missile and space industry.

The first enterprise was the Experimental Design Bureau (OKB-586) formed at the plant in Dnepropetrovsk in the Ukraine by an order of the Council of Ministers dated April 10, 1954. Its mandate was to create a new generation of military ballistic missiles.¹⁴⁶ Ustinov offered the chief designer's job of the organization to Yangel, who accepted without any hesitation. The ambitious engineer had been interested for a while in heading his own design bureau and, like Korolev, had been unhappy with the situation at NII-88. Yangel was officially named to head OKB-586 on July 9 and brought with him to Dnepropetrovsk a number of able engineers from NII-88. With Budnik as his new first deputy, Yangel immediately dove into work on the R-12 missile, considered by the Soviet leadership to be a successor rocket to Korolev's R-5. Originally, Yangel's new missile would have used an engine designed by Sevruc, who had started this research in the first place, but ended up collaborating with a much more powerful individual, Chief Designer Clushko. Although Clushko had been uninterested at first in the R-12, once the program gathered steam, he had Sevruc's work on the engine transferred to his own design bureau. Thus, along with the two engines for the ICBM, in 1952, he began work on a third engine, the RD-211, for the R-12. In contrast to the other two engines, the RD-211 would have a multichamber design with four identical combustion chambers fed by one tur-

142 Biryukov and Yermenko. "50 Years for the Native Rocket-Space Industry": Igor Afanasyev. *R-12 Sandalovoye derevo* (Moscow: EksPrint NV, 1997), pp 6-7

143 Pappo-Korystin, Platonov, and Pashchenko. *Dneprouskiy raketno-kosmicheskii tsentr*, p. 55

144 V. F. Prishchakov and F. P. Sanin. "To the History of Rocket-Space Technique Development in Ukraine," presented at the 45th Congress of the International Astronautical Federation, IAA-94-IAA 2.1.613, Jerusalem, Israel, October 9-14, 1994

145 Sergey Khrushchev. *Nikita Khrushchev krizisy i rakety: vzglyad iznutri tom 1* (Moscow: Novosti, 1994) pp 281-83

146 Pappo-Korystin, Platonov, and Pashchenko. *Dneprouskiy raketno-kosmicheskii tsentr*, p. 56.

bopump. Total thrust was about sixty-five tons.¹⁴⁷ The RD-211 would be Glushko's very first high-thrust liquid-propellant rocket engine using storable propellants, establishing a tradition in his design bureau that would have dramatic repercussions within ten years.

The second independent branch was opened at Zlatoust in the Urals at the former plants number 66 and 385, which had up to that time specialized in the serial manufacture of early ballistic missiles. As part of Ustinov's master plan. Serial Design Bureau No. 385 (SKB-385) was restructured, and one of Korolev's youngest proteges, apparently at the recommendation of Korolev himself, was appointed the organization's chief designer on March 11, 1955.¹⁴⁸ The thirty-year-old Viktor P. Makeyev was transferred from OKB-1 to the new firm to lead the development of a new generation of tactical missiles, with ranges from 200 to 300 kilometers. His experience as the lead designer of the tactical R-11 rocket no doubt played a major role in his appointment, and Makeyev's SKB-385 would soon inherit all naval rocketry development from Korolev's OKB-1, moving to become the premier developer of naval ICBMs in the world.

The conflict with Yangel and the subsequent creation of two new and independent rocket design bureaus in the Soviet Union may have temporarily diluted Korolev's powers, but his influence, both on an official and a personal level, continued to grow slowly. This was clearly in no small part because of his change of heart over the issue of membership in the Communist Party of the Soviet Union. Of the major rocketry designers, he remained one of the few who never joined the Party. The problem was compounded by the resistance of many local Party leaders in recruiting a known and convicted "enemy of the state": Korolev, of course, had yet to be formally rehabilitated for his "crimes" of the 1930s. He attended classes at the Mitshinskii Evening University on Marxism-Leninism, finishing his coursework with distinctions in 1950. Unable to forget the toils of his past, he evidently remained unsure of whether to join the ranks of card-carrying communists. In 1952, at the prompting of several local Party officials at Kaliningrad, Korolev finally decided to begin the process of applying for membership. In March, he was accepted as a candidate member. The doubts about his "criminal" past were put to rest by a number of recommendations from associates such as Pobedonostsev and Kozlov. Perhaps influenced by Yangel's swift rise to the directorship of NII-88, Korolev formally applied for full membership of the Party in early June 1953, soon after his return from Kapustin Yar following a series of R-5 launches.¹⁴⁹ It was a critical moment in his career, for a rejection of his application would have surely necessitated his resignation as chief designer at NII-88's OKB-1, effectively ending his career. Korolev had reason to worry because it was extremely unusual for a former prisoner to become a Party member. Fortunately, at a meeting at Kaliningrad the following month, he was finally accepted as a member of the Communist Party of the Soviet Union.

The joining of the Party was an important factor in getting another distinction. The same year on October 23, Korolev and Chief Designer Glushko were elected two of approximately 300 new Corresponding Members of the USSR Academy of Sciences, the second highest ranking honor for a scientist in the nation.¹⁵⁰ Being the only two engineers in the entire rocketry industry who were bestowed such an honor, it was a significant recognition of the power that

147. Biryukov and Yeremenko. "50 Years for the Native Rocket-Space Industry": Afanasyev, *R-12*, pp. 6-7; Prishchepa. "From the History of the Creation," p. 130.

148. Khrushchev. *Nikita Khrushchev*, p. 284. The SKB-385 was originally established on December 15, 1947. See Maxim Tarasenko, "Evolution of the Soviet Space Industry," presented at the 46th Congress of the International Astronautical Federation, IAA-95-IAA.2.101, Oslo, Norway, October 2-6, 1995. Ye Tkachenko, "The KB Named After Academician Makeyev—50 Years" (English translation), *Novosti kosmonavтики* 26 (December 15-31, 1997) 75.

149. Golovanov, Korolev, p. 441; A. P. Romanov and V. S. Gubarev, *Konstruktory* (Moscow: Politicheskoy literatury, 1989), p. 65.

150. Keldysh, ed. *Tuorcheskoye naslediyе akademika Sergeya Pavlovicha Koroleva*, p. 344; Chertok. *Rakety i lyudi*, p. 391.

the two designers yielded. As members of the Department of Technical Sciences in the Academy, Korolev and Glushko not only gained widespread recognition for the first time, but also were privy to a few but important financial perks given to all Corresponding and Full Members of that organization.

For Korolev, as the years passed, the workload also increased, and he found less and less time for pleasure. Most of his personal time was spent with his second wife Nina P. Koroleva, whom he had married in May 1947 soon after she found work at NII-88. While he frequently traveled to and from Kapustin Yar and Kaliningrad. Korolev and his wife and daughter were not allowed to leave the country for any reason. Although he continued to harbor ill feelings toward many of the leaders of the Soviet government, it would be erroneous to suggest that he suppressed "anti-Soviet" feelings in the hopes of seeing his dreams of space travel emerge in reality. In fact, by all accounts, Korolev clearly had a strong and profound love for his country, and his interest in creating such deadly weapons as ICBMs was more than just a byproduct of his love for space exploration. He did often, however see the absurdity of being involved in such sensitive technology programs.

In January 1953, during a sudden warm period in the weather, an area in the central USSR was flooded by melting ice. A missile depot in that region, storing tens of R-1 missiles for battle, was luckily saved from the flood because of the careful construction of storage buildings. Unfortunately, the water entered thousands of subterranean mice burrows, and finding no other place to take shelter, the mice flocked to the missile depot by the thousands. As it happened, the mice found the insulation wiring of the numerous missiles to be quite edible. When news of the incident found its way to the higher leadership, the artillery command was furious and sent Maj. General Lev M. Gaydukov to the depot, where he relieved the local commander, a General Volkodav, on the spot for "criminal negligence." Soon, hundreds of cats and repairmen were rushed to the depot to take care of the problem. When Korolev heard about the entire episode, he reportedly laughed himself to tears, much to the alarm of General Volkodav, who accused Korolev of building a missile with edible insulation.

Famous physicist Academician Andrey D. Sakharov, who was one of the leading individuals in advanced nuclear weapons research in the Soviet Union, has provided some revealing insights to Korolev's character. Sakharov, along with the nuclear physicist Igor V. Kurchatov, met Korolev at the end of 1953 during a break from their work at the famous KB-11, the primary nuclear weapons design bureau in the USSR. According to Sakharov:



Chief Designer Sergey Korolev stands at the Kapustin Yar firing range in 1953 the same year that he finally joined the Communist Party and was elected a Corresponding Member of the USSR Academy of Sciences (files of Asif Siddiqi)

Korolev was a brilliant engineer and organizer and a colorful personality who shared many of Kurchatov's qualities. . . . Korolev dreamed of the cosmos, and he clung to that dream throughout his youth and his stint with the famous jet Propulsion Research Group [GIRD]. He never believed, as so many did, that the rocket pioneer Konstantin Tsiolkovsky was simply an impractical dreamer. Korolev also shared Kurchatov's rather crude sense of humor. Both took good care of their subordinates and colleagues and had a sure grasp of the practical, but Korolev was possibly a bit more cunning, ruthless, and cynical than Kurchatov.¹⁵²

About the general work of NII-88, Sakharov added:

We had always thought our own work was conducted on a grand scale, but this was something of a different order. I was struck by the level of technical culture: hundreds of highly skilled professionals coordinated their work on fantastic objects they were producing, all in a quite matter-of-fact, efficient manner."

Korolev's relationship with the post-Stalin leadership stabilized over time. Of the four major players, he had had cursory relationships with Beriya, Bulganin, and Malenkov. The latter two had headed the important Special Committee No. 2, but they had evidently remained outside the *de facto* loop of command over the missile program. Thus, with Beriya gone, the new leadership was in the curious position of inheriting a massive and complex program of research that had been completely concealed from them. The fourth major power player, Khrushchev, had met the Korolev a few times during the Stalin regime, but they had never developed a personal relationship at the time. Khrushchev's description of Korolev's first meeting with the new Party leadership is revealing:

Not too long after Stalin's death, Korolyov came to the Politbureau [sic] meeting to report on his work. I don't want to exaggerate, but I'd say we gawked at what he showed us as if we were a bunch of sheep seeing a new gate for the first time. When he showed us one of his rockets, we thought it looked like nothing but a huge cigar-shaped tube, and we didn't believe it could fly. Korolyov took us on a tour of the launching pad and tried to explain to us how the rocket worked. We were like peasants in a marketplace. We walked around and around the rocket, touching it, tapping it to see if it was sturdy enough — we did everything but lick it to see how it tasted."

Speaking of the new ICBM proposal, Khrushchev had unending praise for Korolev:

We had absolute confidence in Comrade Korolyov [sic]. We believed him when he told us that his rocket would not fly, but that it would travel 7,000 kilometers. When he expounded or defended ideas, you could see passion burning in his eyes, and his reports were always models of clarity. He had unlimited energy and determination, and he was a brilliant organizer.¹⁵⁵

152 Sakharov *Memorrs* p 177

153 *lbrd*

154 Khrushchev *Khrushchev Remembers* pp 45-46

155 *lbrd*

Firsthand descriptions of his character describe someone who was capable of both outright belligerence and unexpected generosity—a man single-mindedly driven by the dream of space travel. Transcending any possible cliché of the devoted scientist, Korolev was more than the sum of his attributes, a surprisingly humane and emotionally explosive person with both strengths and failings, but ultimately possessed of invaluable genius for managing his engineers. One military associate from the 1950s recalled that:

Korolev was not only a scientist and designer, but also a great organizer. He never hesitated to take risks, but his risk-taking was always calculated. Sometimes he would take a decision which he intuitively knew to be wrong, but he still wanted to test it and try it out as if he needed to convince himself that it was truly wrong. He would steamroll anything and anybody that tried to prevent him from making a decision which he deemed necessary and proper. Indeed, his main character trait was his iron will. He was very self-disciplined, resolute, certain about what he wanted, and intent on achieving his goals at any cost.¹⁵⁶

Despite increased socialization with the upper leadership of the Kremlin, the cultured Korolev never overcame the deleterious effects of his time in prison. Anatoliy P. Abramov, an engineer at the design bureau, recalled many years later that Korolev:

used to take his meals with his deputies and assistants, all sitting around in a big table in the canteen. Korolev had a good sense of humor and his presence never intimidated the others sitting around the table. He ate very quickly paying more attention to answering questions than to the meal. After finishing the food on his plate he would wipe it clean with a piece of bread which he subsequently put in his mouth. He even scooped up crumbs and ate them. The people around him looked on with amazement until someone volunteered that this was a habit he had developed during his years in prison and in labor camps.¹⁵⁷

The successes of the early Soviet ballistic missile program did not, obviously, belong only to Korolev. Other engineers, artillery officers, and defense industry bureaucrats were instrumental in the creation of the vast infrastructure that supported the development of the R-1, R-2, R-5, and R-11 missiles. But Korolev was the heart of that effort, the one who synthesized the abilities and talents of thousands. By 1953, he was poised to begin the most important phase of his life. A man profoundly affected by the history of the Soviet Union, he began to harness his own energies to affect the history of the world.

156. Mozzhorin, et al., eds., *Dorogi v kosmos: I*, pp. 112–13.

157. Mozzhorin, et al., eds., *Nachalo kosmicheskoy ery*, p. 44.



CHAPTER FOUR SPUTNIK

Stalin's death in 1953 signaled the beginning of a new era in the history of the Soviet state. As with every other arena of Soviet life, the effects on the rocketry sector were not clear immediately. Given that Stalin himself had an unusually important role in approving or canceling weapons development projects, the new members of the Politburo were less than prepared to handle the institutional and operational challenges of the emerging long-range ballistic missile program. While Beriya, Bulganin, Khrushchev, and Malenkov had found themselves as the major power brokers in the post-Stalin leadership, one by one, three of them were eliminated from the picture in the ensuing years. Nikita Sergeyevich Khrushchev emerged as the most powerful and influential Communist Party leader in the country. Of the four individuals, Khrushchev was, however, the one person least familiar with the workings of the defense industry. His inexperience with the sector, combined with the necessity of revamping an institutional structure set up in the Stalin days, seems to have set the stage for a great degree of flux and ambiguity in the chain of command in the missile programs during the four-year period from 1953 to the first Sputnik launch in 1957. This amorphousness engendered a climate for facilitating the decision to develop and launch the first artificial satellite.

Operation Baykal

Through the end of 1953 and the beginning of 1954, specific requirements for the first Soviet ICBM were established at NII-88 during a series of important meetings, which finally brought together nuclear weapons and rockets to create a potent combination. The first step prior to using nuclear explosives on the ICBM was deployment of more modest rockets, such as the short-range R-11 and the medium-range R-5. It was during this period that Korolev's enterprise and the rest of the rocketeers for the first time came into contact with bureaucrats in the Ministry of Medium Machine Building, the individuals responsible for administering the top-secret nuclear weapons program. Following the end of the Stalin and Beriya era, Minister Malyshev and his deputies from the Ministry of Medium Machine Building almost by default inherited jurisdiction over the missile effort—an unusual state of affairs prompted in part by the ignorance of many high Communist Party leaders on the nature of important military programs.

The collaboration with the nuclear scientists began with an exploratory visit to NII-88 on October 19, 1953, by representatives of the Ministry of Medium Machine Building, who met NII-88 Chief Engineer Yangel to inquire about the basic parameters of the R-5 missile. Korolev was at the time in Kapustin Yar inaugurating the second series of R-5 testing, and upon hearing of the visit, he quickly flew back to Moscow in time for a formal visit by Malyshev to

discuss the details of the operation.¹ What emerged from the meeting was an order to modify the two existing missiles into their nuclear weapons variants, the R-11M and the R-5M. The modifications were to rely entirely around issues of reliability, stemming from the understandable concern about putting atomic bombs on inefficient missiles. Given the generally poor performance of newly designed rockets, the pressure was on Korolev to satisfy requirements that were far beyond anything needed before. Close cooperation was called for with the scientists from the Arzamas-16, who, by some accounts, often acted condescendingly to the engineers at OKB-1. Having been the most coveted defense scientists in the Soviet Union, for the first time, the nuclear scientists were forced to submit to design requests from the rocketry industry. One OKB-1 engineer recalled later:

At the start of this work Sergey Pavlovich [Korolev] gathered the project leaders to make a speech concerning the program. This was a meeting before the start of work with the [Ministry of Medium Machine Building]. The first thing he said was that we ought to be very careful in our activities because they had been spoiled due to publicity and considered themselves superior to everybody else after developing the atom bomb. S. P. Korolev said that at least in the beginning we should pander to them but pander very carefully such that in the end we would prove to them that we were in the driver's seat and they were merely passengers.

Symptomatic of many other rivalries between organizations within the defense industry, the friction between the nuclear and rocket scientists eventually came to a stalemate, but it was a conflict that served as a vehicle to dramatically increase the prominence and clout of the missile engineers.

The Soviets conducted a third series of R-5 testing at Kapustin Yar between August 12, 1954, and February 7, 1955, which verified initial concepts for modernizing the base vehicle. These tests essentially cleared the way for the "nuclear" variant, which had a slated range of 1,200 kilometers and a launch mass of just over twenty-eight and a half tons, slightly less than its predecessor.² Korolev himself inaugurated the grueling test series for the new R-5M on January 20, 1955. Coordinating the work with the nuclear weapons engineers and scientists, OKB-1 engineers slowly eliminated a variety of major technical problems during as many as seventeen launches from site 4N at Kapustin Yar, which lasted up to July 1955. Of the launches, only two deviated from their assigned trajectories: their flight was terminated using a special system that switched off the engines in flight. Engineers also studied the impact of dummy steel warheads, which provided information on detonation devices.³ Korolev was acutely aware of the importance of the work on the new missile, not only because it represented a new step for national defense as a whole, but precisely because of its relevance in consolidating the influence and respect for the work at his organization. In many ways, it was the first crucial step that would make or break the latent aspirations of a future space program under his direction.

¹ Yaroslav Golovanov, *Korolev. Fakty i mify* (Moscow: Nauka, 1994), pp. 456-57. Also present were Ministry of Medium Machine Building Directorate Chief G. N. Pashkov, Ministry of Defense Industries Deputy K. N. Rudnev, and a host of senior engineers from NII 88. The meeting is said to have occurred in November 1953. See Boris Nikolayevich Kantemirov, "The History of the Selection of the Design Principles for the First ICBM: the R-7," presented at the 10th International Symposium on the History of Astronautics and Aeronautics, Moscow State University, Moscow, Russia, June 20-27, 1995.

² Yu. A. Mozzhorin et al., eds., *Nachalo kosmicheskoy ery: vospominaniya veteranov raketno-kosmicheskoy tekhniki i kosmonavtiki: vypusk utoroy* (Moscow: RNIISKD, 1994), p. 69.

³ Yu. V. Biryukov, "Materials from the Biographical Chronicles of Sergey Pavlovich Korolev" (English title), in B. V. Raushenbakh, ed., *Iz istorii sovetskoy kosmonavtiki* (Moscow: Nauka, 1983), p. 234. B. Ye. Chertok, *Rakety i lyudi* (Moscow: Mashinostroyeniye, 1994), p. 302.

⁴ Golovanov, *Korolev*, p. 460; Chertok, *Rakety i lyudi*, p. 389; Steven J. Zaloga, *Target America: The Soviet Union and the Strategic Arms Race, 1945-1964* (Novato, CA: Presidio, 1993), p. 138.

After four final certification launches in January 1956, the Soviet government established a special State Commission for testing the live nuclear-tipped missile; this organization was chaired by Pavel M. Zernov, under whose leadership the KB-11 firm had developed the first Soviet nuclear bomb.⁵ The exercise was code-named Operation Baykal. The fateful day of the launch. February 2, 1956. Korolev, Voskresenskiy, Pilyugin, and nuclear weapons engineer Aleksandr P. Pavlov gathered at the command point about six kilometers from site 4N to watch the launch. Tension was high at the launch site because, for the first time during the Soviet rocketry program, a live atomic bomb was sitting on top of a rocket. Engineers undertook special measures in case the rocket deviated from its path. One of these included the establishment of the Missile Accident Command Post—that is, a group of engineers who would use their mathematical acumen in real time to distinguish a nominal trajectory from an unacceptable deviation.⁶ The launch went off without a problem, and the observers at the impact site were able to observe the effects of the spectacular nuclear explosion, telephoning back to Kapustin Yar: "We observed *Baykal*."⁷

For Korolev and his engineers at NII-88, this was a watershed moment. The years of uncertainty and suspicion from military leaders evaporated in a flush of euphoria. Especially happy with the test and NII-88's performance was Marshal Nedelin, at the time the Deputy Minister of Defense responsible for the procurement of all armaments. Within days, NII-88 was graced by a visit by the top Soviet leadership, including Presidium members such as Nikita S. Khrushchev, Nikolay A. Bulganin, Vyacheslav M. Molotov, Lazar M. Kaganovich, and Nikolay K. Kirichenko.⁸ It was an unprecedented honor, heretofore reserved only for the nuclear weapons scientists, which contrasted sharply with the treatment the institute had received in its first ten years of existence. As a mark of recognition of the rocketeers' remarkable work, a decree on April 20, 1956, awarded the highest civilian honor possible for a Soviet citizen, the Hero of Socialist Labor, to the entire Council of Chief Designers (Korolev, Glushko, Pilyugin, Ryazanskiy, Barmin, and Kuznetsov) and two other missile experts (Isayev and Korolev's First Deputy, Mishin).⁹ Korolev's other employees—twenty of them, including Bushuyev, Chertok, Okhapkin, Voskresenskiy, Kryukov, and Makeyev—were awarded the less prestigious Order of Lenin. The R-5M missile itself was formally adopted as armament of the Soviet armed forces by an order dated June 21, 1956, serving as the first operational nuclear-tipped missile in the Soviet inventory.¹⁰ The improvement in the fortunes of NII-88 and OKB-1 was particularly significant for Korolev's future space plans; for the first time since his appointment as chief designer in 1946, he had direct access to the top individuals in the Soviet leadership, facilitating quicker

5 Christian Lardier *L'Astronautique Soviétique* (Paris: Armand Colin, 1992), p. 84. Other members of this state commission were nuclear weapons experts Ye. A. Negin and N. A. Petrov; military officers M. I. Nedelin (a Deputy Minister of Defense), N. D. Yakovlev (Commander of Air Defense Troops), A. G. Mrykin (the chief representative from the Chief Artillery Directorate for missile affairs), V. I. Voznyuk (Commander of Kapustin Yar), and P. A. Degtyarev (from the Chief Artillery Directorate); bureaucrats D. F. Ustinov (Minister of Defense Industries) and S. I. Vetoshkin (Ustinov's First Deputy); and engineers S. P. Korolev, V. P. Glushko, N. A. Pilyugin, M. S. Ryazanskiy, V. P. Barmin, and V. I. Kuznetsov.

6 Yuriy A. Mozzhorin et al., eds., *Dorogi v kosmos I* (Moscow: MAI, 1992), p. 29. The system installed on the missile was designated the Automatic Rocket Disablement (APR) system, which switched off the main engines on a wayward missile. See Chertok, *Rakety i lyudi*, p. 388.

7 Zaloga, *Target America*, p. 139.

8 Golovanov, *Korolev*, p. 464.

9 V. Pappo, Korystrn, V. Platonov, and V. Pashchenko, *Dnepropetrovskiy raketno-kosmicheskiy tsentr: kratkiy ocherk stanovleniya i razvitiya* (Dnepropetrovsk: PO YuMZ/KBYu, 1994), pp. 58–59. Note that Mishin was the only non-chief designer to be awarded. Note also that Isayev was given his Hero of Socialist Labor for the development of the S-25 Berkut surface-to-air missile system and not the R-5M.

10 I. D. Sergeev, ed., *Khronika osnovnykh sobyitii istorii raketnykh voysk strategicheskogo naznacheniya* (Moscow: TsIPK, 1994), p. 35.

and often effective decision-making for projects that had elicited little or no interest from both Communist Party and government leaders during the preceding years.

There was a clear level of flux in the policy and management of the Soviet missile programs in the years following 1953 and leading up to 1957, when Khrushchev conclusively consolidated his power. The Special Committee No. 2, which in its various incarnations had supervised all policy decision-making since its inception in 1946, had ceased to exist as an independent entity in 1949. Later, the nuclear, missile, and air defense programs were all consolidated under Vyecheslav A. Malyshev within the Ministry of Medium Machine Building in 1953. This managerial setup lasted only two years before the Soviet leadership—that is, Malenkov and Khrushchev—decided to concentrate all missile industry supervision under one governmental entity that superseded ministerial jurisdiction. On April 14, 1955, the government created the "Special Committee for Armaments for the Army and Navy of the USSR Council of Ministers" by uniting several former departments from the Ministry of Medium Machine Building and subordinating it directly to the USSR Council of Ministers. By December 1957, this same committee would be renamed the Military-Industrial Commission (VPK), the infamous institution that managed the Soviet military-industrial complex through the entire Cold War.¹¹ Officially, the role of VPK was "to transform the Party's weapons policy decisions into coordinated plans and assignments, and to ensure that those tasks were accomplished as directed."¹² As Khrushchev himself became the sole arbitrator of Party weapons policy by the late 1950s, VPK served as an implementation mechanism for his pet defense projects. Eventually, there would not be a single program in the entire defense sector, including the future space program, which would get off the ground without the signature of the chairman of VPK.

Malyshev, having done much for the growth of the ballistic missile program, was not to be witness to the Soviet space program. When his "sponsor," Presidium member and chairman of the Council of Ministers Georgiy M. Malenkov, was demoted in February 1955, Malyshev's fortunes took a dive. Within months, he lost his grip on power and was demoted to a relatively innocuous position. An ambitious and intelligent man, he was devastated by the course of events. He died within a year of acute leukemia.¹³ For Korolev, Malyshev's removal had positive implications. Never close to the chief designer, Malyshev had consistently opposed Korolev's grander plans for space exploration, perhaps suspecting in Korolev a penchant for idle dreaming, which had no relevance to consolidating the defensive might of the Soviet Union.

¹¹ The new Special Committee traced its ancestry back to the Third Chief Directorate of the USSR Council of Ministers established on February 3, 1951, to oversee the development of all Soviet short- and long-range missiles. On July 1, 1953, the Third Chief Directorate was subordinated to the new Ministry of Medium Machine Building and renamed GlavSpetsMash (Chief Directorate of Special Machine Building). GlavSpetsMash evidently supervised Soviet missile development from 1953 to 1955. The role of the Ministry of Defense Industries under D. F. Ustinov, which had traditionally overseen industrial development of missiles in the 1940s and 1950s, is unclear during this period. On April 14, 1955, several subordinate departments of the Ministry of Medium Machine Building, including GlavSpetsMash, GlavSpetsMontazh (Chief Directorate of Special Assembly) and GlavTransMash (Chief Directorate of Transport Machine Building) were separated from the ministry, henceforth releasing the ministry from any oversight over missile programs. Some of the newly independent departments, including design bureaus such as KB-1 and OKB-2, were transferred to the Ministry of Defense Industries under Ustinov. The remainder, including a large portion of the old GlavSpetsMash, was consolidated into a single entity and subordinated directly to the USSR Council of Ministers, serving as the backbone of the new "Special Committee for Armaments of the Army and Navy." The chairman of the committee was V. M. Ryabikov. The first deputy chairman was C. A. Titov. The two deputy chairmen were A. K. Repin and A. N. Shchukin. The four remaining members were C. N. Pashkov, V. V. Il'yuvnev, P. I. Kalinushkin, and B. A. Kyasov. See Grigoriy Kisunko, *Sekret'naya zona* (Moscow: Sovremennik, 1996), pp. 305-367; Arkadiy Kruglov, *Shtab atomnogo proma* (Moscow: TsNIIatominform, 1998), pp. 107-117.

¹² William P. Barry, "The Missile Design Bureaus and Soviet Piloted Space Policy, 1953-1970," Ph.D. thesis in Politics, Faculty of Social Studies, University of Oxford, 1996.

¹³ Andrey Sakharov, *Memoirs* (New York: Alfred A. Knopf, 1990), p. 184.

Malyshev's replacement as missile project coordinator was an unusual choice, but one who was evidently more sympathetic to Korolev: Vasily M. Ryabikov. The latter had by far one of the most unusual careers in the defense industry—and one whose full facet is still unexplained by declassified information. Ryabikov had served as Ustinov's First Deputy at the Ministry of Armaments until 1951, overseeing the work at NII-88. In February 1951, he was appointed to lead the Third Chief Directorate of the USSR Council of Ministers, a top-secret body established among other things to develop the first Moscow air defense system.¹⁴ His sudden rise to a position of such great importance after a stint as a deputy minister is inexplicably hidden among the minutes of Politburo meetings. From 1953 Ryabikov served briefly under Malyshev, overseeing Soviet missile programs before being tapped to be chairman of the new Special Committee in April 1955. It was a curious position for him because he now served as Ustinov's boss, whereas only a few years before,

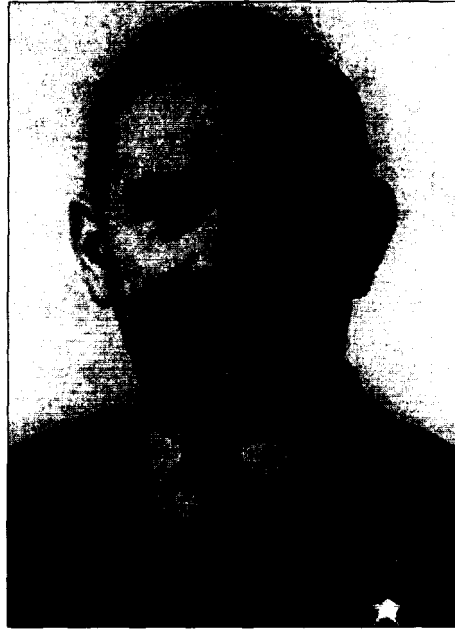

Vasily Ryabikov shown here in an official government portrait, headed the so-called "Special Committee of the Council of Ministers" from 1955 to 1957. As manager of the Soviet defense industry during that period, Ryabikov was the most important government official responsible for the genesis of the Sputnik satellite program (files of Peter Gorin)

their roles were reversed.¹⁵ One persuasive Western analysis of Ryabikov's precipitous rise suggests that Ryabikov was an important element in Beriya's control of top-Secret programs, and after the latter's fall, Malyshev and Ryabikov were among many who remained behind from the "Beriya group" to serve as a foil against Khrushchev's own overtures for a complete monopoly of power."

Little is known about Ryabikov's personality or allegiances, although it has been suggested that he was not a strong supporter of Korolev's plans." While he may not have been as supportive as Ustinov, Ryabikov was clearly an improvement over the much more traditional Malyshev, with whom Korolev had many a spat. Ryabikov's supervision over the implementation of the missile program was facilitated by a number of deputies, including Georgiy N. Pashkov, a strict Party-line man, who, like Ryabikov, had a long history of involvement in the rocketry industry, both as a member of the Special Committee No. 2 and also in Gosplan, the

¹⁴ Col Cen (Ret) Yu V Votintsev "Unknown Troops of the Vanished Superpower" (English title) *Voyennoistoricheskiy zhurnal* no 8 (August 1993) 54-61

¹⁵ For reasons that are still unclear Ryabikov's role as chairman of the new Special Committee has gone almost entirely unmentioned in Soviet or Russian sources. Rare references can be found in Mozzhorin *et al* eds *Nachalo kosmicheskoy ery* p 164 Yu P Semenov ed *Raketno Kosmicheskaya Korporatsiya 'Energiya' rnen S P Koroleva* (Korolev RKK Energiya 1996) pp 79-87. His standard biography usually refers to his role as a 'committee chairman in the USSR Council of Ministers' from 1955 to 1957. See John McDonnell 'The Soviet Defense Industry as a Pressure Group' in Michael McGwire, Ken Booth, and John McDonnell eds *Soviet Naval Policy: Objectives and Constraints* (Halifax NS: Centre for Foreign Policy Studies 1975) p 119. From 1953 to 1955 Ryabikov had successively served as the chief of GlavSpetsMash and GlavSpetsMontazh within the Ministry of Medium Machine Building, titles equivalent to a deputy minister in the ministry. See Kisunko *Sekretnaya zona* p 276.

¹⁶ Barry "The Missile Design Bureaux "

¹⁷ *Ibid*

state economic planning organ. Ustinov, still the Minister of Defense Industries, which oversaw NII-88 during this period, continued to maintain very close relationships with Korolev and other chief designers. There is no evidence to suggest that there was any friction between Ustinov and Ryabikov once their positions were reversed. An extremely valuable ally for Korolev. Ustinov was crucial in shielding and protecting NII-88 from undesirable orders.

During the mid-1950s, Korolev also benefited from changes in the military—in particular, the transfer of the important NII-4 organization from the Academy of Artillery Sciences to the Fourth Directorate of the Chief Artillery Directorate, the latter being his primary client for missiles. Many military leaders saw this academy as a hostile environment, nurturing scientific dreamers such as Tikhonravov, but ironically it had become too ineffectual for Korolev's liking. After a tumultuous lifetime, the academy was eventually dissolved on April 23, 1953, and its subordinate NII-4, which included Tikhonravov's group, was transferred directly to the command of the Fourth Directorate, renamed the Directorate of the Deputy Commander of Artillery.¹⁸ With direct access to a sympathetic directorate commander, Maj. General Andrey I. Sokolov, Tikhonravov was in a better position to reinforce the important work on artificial satellites carried out at NII-4. There was a minor reshuffle during 1954–55, when Sokolov was fired from his post because of a Party "witch-hunt," but the resourceful artillery general struggled his way back and was appointed to personally head NII-4 in late 1955.¹⁹ An employee of NII-4 noted later that "in connection with Sokolov's [appointment] there was a sharp reinforcement of work on space themes" at the institute, adding that the relationship with Nil-88 showed a significant improvement.²⁰ Furthermore, the number of people in Tikhonravov's satellite and launch vehicle group increased dramatically following the change in NII-4 leadership. Another change in favor of Korolev and Tikhonravov was the appointment of Marshal Nedelin in March 1955 to the new post of Deputy Minister of Defense for Special Armaments and Reactive Technology.²¹ With a far more favorable attitude toward Korolev after the success of the R-5M, Nedelin was a key factor in Korolev's rise, given that the former had direct access to Khrushchev and the rest of the Presidium. Nedelin's new role was to direct the acquisition and integration of new armaments. Including ballistic missiles, into the Soviet armed forces. If a satellite were to lift off from Soviet soil, it would be Nedelin who would allow the use of a missile for such a project.

All these changes, seemingly unrelated, each served to reinforce Korolev's standing in key areas. Without the support of these individuals, the first Soviet satellite would not have lifted off when it did. The dismissal of Malyshev, the new appointments of Ryabikov, Sokolov, and Nedelin, the transfer of Nil-4, and most of all the success of the R-5M were pivotal events, which came at a very opportune moment in the history of the Soviet ballistic missile program. While a decision on a space satellite was still months away, the pieces in the puzzle were finally beginning to fall into place, as the fortunes of Korolev's group of engineers began to take a historic turn. The last and perhaps most important element of the picture, the ICBM, was already in design. The doors were beginning to open up.

18 Yu A Mozzhorin *et al* eds *Dorogi v kosmos II* (Moscow MAI 1992) pp 94–95 Note that Sergeev ed *Khronika osnovnykh sobytiy istorii* p 6 states that the Directorate of the Deputy Commander of Artillery (UZKA) was formed on April 18 1953

19 *Ibid* pp 97–98 UZKA was itself renamed the Directorate of the Chief of Reactive Armaments (UNRV) in March 1955 and was headed at the time by Maj. General A. I. Semenov a veteran of the A-4 recovery effort in Germany after World War II

20 *Ibid* pp 95–97–98

21 Sergeev ed *Khronika osnovnykh sobytiy istorii* pp 6–7

CHALLENGE TO APOLLO

Alternatives

The T1 and T2 directives from February 1953 sanctioned design work to create intercontinental ballistic and cruise missiles, both to be created at NII-88's OKB-1. Increasingly by late 1953, work on the T2 theme had begun to conflict with the heavy workload on ICBM development—that is, the T1 theme. Cruise missile development was effectively limited to the creation of the short-range experimental EKR vehicle, although it was understood that the EKR would lead directly to a full-scale intercontinental project. By the end of 1953, NII-88 had begun manufacturing various components of the EKR, while ground tests of OKB-670's ramjet engine were producing good results. A special commission formed to monitor the EKR program's progress, which included Academicians Keldysh and Khristianovich, recommended at the time that the research results from the EKR had been so positive that they should move directly to an intercontinental missile instead of building the interim missile." Similar to the abandonment of the R-3 and the jump to an ICBM, it was the second time that Soviet engineers and scientists decided to forego an interim vehicle in favor of a direct leap to an intercontinental missile. Both Korolev and Keldysh were acutely aware that OKB-1 alone would not be able to handle both tasks, and after some "anguished discussions," Korolev decided to let go of the cruise missile option and have it transferred to other design bureaus, specifically ones in the aviation industry whose extensive experience in developing long-range bombers would come in handy." For Korolev, this was in many ways the most visible manifestation that his thinking had irrevocably moved from winged missiles, his dream in the 1930s, to ballistic missiles as a means to explore the upper atmosphere and outer space.

Keldysh's NII-1 had retained overall scientific supervision over the intercontinental cruise missile program, but the actual engineering tasks were distributed to two aviation design bureaus, both of which would eventually become two of the most important organizations in the Soviet space program. Each would design and build its own intercontinental cruise missile, in effect competing against each other to deliver a working model to the Soviet armed forces. In a uniquely Soviet version of "competitive markets," it was not odd for two design bureaus to be assigned projects simultaneously—programs that were geared toward roughly the same requirements. Both proposals would often reach the point of flight testing under supervision of the primary client, the Ministry of Armed Forces (later the Ministry of Defense). Based on the results, the ministry would choose one for full-scale production and integration into the armed forces. The decision to adopt not only was, of course, based on the performance of the given systems in their testing regime, but also was often a function of the level of cordiality between the given chief designers and the Soviet leadership. Because failure for a design bureau could quite often mean the termination of its existence, engineers considered the development of high-stakes weapons such as cruise missiles very seriously.

The organization picked to produce the first cruise missile was the Experimental Design Bureau No. 301 (OKB-301), located at Khimki and headed by fifty-three-year-old Chief Designer Semyon A. Lavochkin, one of the most famous airplane designers in the Soviet Union. Established in July 1937, this design bureau had produced a number of fighter aircraft, such as the LaGG-3, La-5, La-5F, La-5FN, and La-7, which were used extensively during World War II. Later, Lavochkin led the development of several experimental jet aircraft, such as the La-160, the first Soviet aircraft with swept-back wings, and the La-176, the first Soviet aircraft to break the speed of sound. By the early 1950s, OKB-301 had branched out into missiles: its first

22 I Afanasyev "Without the Secret Stamp Halt the Work Destroy the Materials" (English title) *Aviatsiya i kosmonavtika* no. 6 (June 1993) 42-44

23 Chertok *Rakety i lyudi* p. 290

forays into the field included the V-300 missile for the Moscow air defense network, code-named Berkut, and the "201" ramjet-powered air-launched drone.²⁴

The second aviation organization tapped was the Experimental Design Bureau No. 23 (OKB-23), a relatively new firm that had no prior experience in designing missiles. Instead, it was undertaking important work on long-range bomber design. In the spring of 1951, Stalin had called in Andrey A. Tupolev, the famous aviation patriarch and chief designer of the Moscow-based OKB-156, to discuss the future of strategic intercontinental bombers. When asked to start work on a long-range jet-powered bomber, the old airplane designer firmly refused, arguing that Soviet technology was insufficiently advanced to handle such a task. The furious Stalin took the matter elsewhere and assigned the job to Vladimir M. Myasishchev, a forty-eight-year-old aeronautical engineer who happened to be Tupolev's son-in-law. Myasishchev's achievements up to 1951 had been nothing to boast about. He had worked on various airplanes through World War II as a prisoner, first under Tupolev and later at the independent OKB-482, but none of them had been adopted for serial production. Perhaps seeing a chance to bring some "new blood" into strategic weapons development, Stalin signed an order on March 24, 1951, that gave Myasishchev a new organization, OKB-23, located at the legendary State Aviation Plant No. 23 in Fili. For his new team, the new chief designer gathered up more than 1,500 of the best Soviet aeronautical engineers from the Moscow Aviation Institute (TsAGI) and from his old prison days, transferring all of them to the Fili plant. Established on April 30, 1916, in the center of Moscow, this plant had originally produced automobiles but was restructured for aircraft production as early as 1927. The same plant is today known as the M. V. Khrunichev State Space Scientific-Production Center and is one of the primary participants in the creation of the International Space Station."

Both the Lavochkin and Myasishchev intercontinental cruise missiles shared common features with Korolev's never-built EKR. Both vehicles were two-stage missiles. The first stages were powered by liquid propellant rocket engines, while the second stages were equipped with supersonic ramjets. The Lavochkin design, called the La-350 (or V-350), but better known by its nickname "Burya" (meaning "storm"), used a cluster of two long rocket boosters, which served as the first stage. One four-chamber S2.1100 engine (later replaced by the lighter S2.1150) was installed on each of these boosters, generating a total thrust of 137.22 tons at launch. This engine from the Isayev design bureau was almost identical to the engine used on the R-11 short-range tactical missile. The second cruise stage resembled a large aircraft with stubby swept wings at a 70-degree angle and conventional tail surfaces. The main ramjet was the RD-012U from the Bondaryuk design bureau. This engine had an average thrust of 7.65 to 7.75 tons. The missile was a little less than twenty meters long and had an overall mass of

24. For Lavochkin's early work, see A. N. Ponomarev, *Sovetskiye aviatsionnyye konstruktory* (Moscow: Voennoye izdatelstvo, 1990), pp. 183-91; G. P. Svishchev, ed., *Aviatsiya entsiklopediya* (Moscow: Bolshaya Rossiyskaya entsiklopediya, 1994), pp. 304-05. For the Berkut, see Anatoliy Pokrovskiy, "Three Episodes From the Life of Our ABM Defense: There Is No More 'Berkut': What Kind of Geese Will Save Moscow Now?" (English title), *Pravda*, February 3, 1993, p. 4. Votintsev, "Unknown Troops of a Vanished Superpower," pp. 54-61. S. M. Ganin, "The First National Anti-Aircraft System of the Moscow PVO—The S-25 'Berkut'" (English title), *Neuskrybastron* no. 2 (February 1997): 25-32; Steven J. Zaloga, "Defending the Capitals. The First Generation of Soviet Strategic Air Defense Systems 1950-1960," *The Journal of Slavic Military Studies* 10 (December 1997): 30-43.

25. V. A. Fedotov, "The Scientific-Design Activities of V. M. Myasishchev" (English title), *Iz istorii aviatsii i kosmonavtrki* 50 (1984): 3-13; Ponomarev, *Sovetskiye aviatsionnyye konstruktory*, p. 233; Zaloga, *Target America*, pp. 81-82; O. Shinkovich, "The Khrunichev Center—80 Years" (English title), *Novosti kosmonavtrki* no. 9 (April 22-May 5, 1996): 75-77; S. A. Zhiltsov, ed., *Gosudarstvennyy kosmicheskiy nauchno-prorzuodstvennyy tsentr imeni M. V. Khrunicheva* (Moscow: RUSSLIT, 1997), pp. 12, 20. D. N. Osipov was director of the plant from 1952 to 1961. The Ministry of Aviation Industry order for the establishment of OKB-23 was dated May 26, 1951.

CHALLENGE TO APOLLO

ninety-six tons. The La-350 would be capable of delivering a conventional atomic warhead with a mass of 2.19 tons over a maximum distance of 8.500 kilometers.²⁶

The Myasishchev design, designated the M-40 or *Buran* (meaning "blizzard"), had a similar conceptual configuration as its competitor, with the second stage mounted above the first stage like a cluster. The M-40, however, had a different mission than the La-350: it would carry a thermonuclear warhead with a mass of three and a half tons (that is, it had a capacity about one and a half times greater than the Lavochkin design). The first stage of the M-40 consisted of a cluster of four booster rockets, each with a single nitric acid-kerosene engine from the Clushko design bureau. Glushko's concurrent work on the RD-211 engine using these same propellants for Yangel's R-12 intermediate range ballistic missile came in handy for work on the M-40. In 1953, Glushko began work on the RD-212, a modified variant of the RD-211, specifically for Myasishchev's new cruise missile. Testing of the original RD-211 in 1953, however, proved to be fraught with many setbacks. Ground testing of the RD-212 for the *Buran* was eventually never finished because of changes in the requirements for the cruise missile. In August 1956, Myasishchev's engineers recalculated the requirements for the first stage engine, calling for a 22-percent increase in thrust from their original specifications. Thus, Clushko began developing a third engine, the RD-213, to fulfill this requirement for the *Buran*. Using these engines, the first stage of the M-40 had a total thrust of 220 tons at liftoff. The second stage used a single Bondaryuk RD-018A ramjet with thrust of about ten and a half tons. One of Myasishchev's more original ideas was to use the M-40 as the basis for a rocket-plane—that is, one with a specially designed cockpit for a single pilot. The pilot would eject out of the vehicle prior to impact. The length of the overall vehicle was twenty-four meters, and the mass was 125 tons."

The work on the cruise missiles was backed up by an immense investment in basic aeronautical research focused primarily at Keldysh's NII-1—remnants of the considerable efforts expended on the Sanger-Bredt bomber. Each missile had two-part guidance systems, one based on inertial guidance using gyroscopic platforms and double integrating accelerometers for the early stage of flight and the second based on a celestial navigation system that introduced constant corrections to the trajectory during the cruise phase. Scientists at NII-1 designed both systems. The latter was based on years of research at NII-88 under Izrael M. Lisovich, who perfected an operating system for use by both the *Burya* and *Buran* by 1953. The All-Union Institute for Aviation Materials (VIAM) and the N. E. Bauman Moscow Higher Technical School (MVTU) were tasked with the development of heat-resistant structural materials, such as titanium and high-strength stainless steel, which were indispensable for cruise missile operation, as well as the technology to weld them. The venerable TsAGI was responsible for setting the aerodynamic parameters for both missiles, in particular the delta wings and the vehicles' thin supersonic profiles. Although most Western accounts imply that Lavochkin and Myasishchev headed the programs, in truth Academician Keldysh served as the overall coordinator and manager for both of these important projects."

26 V. Aslanov, "Soviet Shuttle' of the 50s" (English title). *Apogee* 5 (June 1993): 1; Yakov M. Natenzon. "The First Cruise Missile 'Burya.'" *Space Bulletin* 1 (1993). 26-27; Boris V. Rauschenbach. "The 'Burya' Intercontinental Cruise Missile." presented at the 43rd Congress of the International Astronautical Federation, IAA-92-0187, Washington, DC. August 28-September 5, 1992; Afanasyev. "Without the Secret Stamp", Christian Lardier, "70 Years of Soviet Ramjets," presented at the 48th Congress of the International Astronautical Federation. IAA-97-IAA 2.3.03. Turin, Italy, October 6-10, 1997; Yevgeniy Yerokhin, "The Missiles of Bondaryuk" (English title). *Krylia rodny* no. 11 (November 1993): 33-37.

27 V. Petrakov and M. Chernyshov, "Without the Stamp 'Secret'. The Unknown *Buran*" (English title). *Souetskaya rossiya*. April 10, 1991, p. 4; Afanasyev. "Without the Secret Stamp": Igor Afanasyev. *R-12 Sandalouoye derevo* (Moscow. EksPrint NV, 1997), p. 8; Lardier. "70 Years of Soviet Ramjets"; Yerokhin. "The Missiles of Bondaryuk."

28 Afanasyev. "Without the Secret Stamp": Rauschenbach. "The 'Burya' Intercontinental Cruise Missile "

The cruise missile and ICBM options were two of three possible strategies for the Soviet search for an intercontinental nuclear delivery system. Given the existing technologies of the 1940s and 1950s, it would have been surprising if the Soviet government had not also been exploring the possibility of using long-range strategic bombers for reaching the contiguous United States. The first jet-engine bomber project for such a mission was Project 25, or "M," at Myasishchev's OKB-23. The aircraft flew its first mission as early as January 1953, less than two years after the program's initiation, and eventually emerged into the modified M-4 Molot bomber, better known by its NATO code-name "Bison-A." Although the bomber entered limited production by late 1955, its operational characteristics (primarily range) fell far short of air force requirements and, in fact, engendered widespread disenchantment among the military. A backup option was "Type 95," developed by Tupolev at OKB-156, which used turboprop instead of jet engines. The project was approved at the same time as Myasishchev's Project 25. When the airplane was accepted for service in August 1957 as the Tu-95, it was full of problems. It would not be until the late 1950s when the modified Tu-95M fulfilled its original long-range requirements, by which time the slow-moving aircraft was already vulnerable to a host of American air defense weaponry.²⁹ By the mid-1950s, the bomber option began to face serious competition as an effective intercontinental weapons delivery system. The overwhelming advantages of missiles and the unprecedented breakthroughs in rocket propulsion technology in the early 1950s threatened to make bombers a memory of a bygone era. There was no more apt a symbol of this change in generations than the world's first ICBM, Korolev's R-7.

The R-7 ICBM

Original conceptions of the first Soviet ICBM as part of the TI theme described a missile with a launch mass of approximately 170 to 200 tons that was capable of delivering a nuclear explosive weighing three tons over a distance of 8,500 kilometers.³⁰ This was compared to the warhead used on the R-5M that was just over one ton. These specifications dramatically changed as a result of developments in the nuclear weapons sector. On August 12, 1953, the Soviet Union exploded its first thermonuclear device at Semipalatinsk, with a power twenty times more than its first atomic bomb.³¹ The original ICBM specifications had been set based on earlier atomic bombs, but later, the Soviet leadership was eager to use a thermonuclear device on the missile. As early as May 1953, there had been preliminary discussions on using the hydrogen bomb (H-bomb) on the ICBM, but a cementing of this position did not occur until later in the year. Andrey D. Sakharov, the brilliant physicist at KB-11, played an unusual and critical role in the requirements for the ICBM. In late 1953, Minister of Medium Machine Building Malyshev had asked Sakharov to write a brief report on the "conception of a second generation [thermonuclear] device."³² Under pressure and in a hurry, Sakharov was in a difficult position. He later recalled,

29. Bill Cunston, *The Osprey Encyclopedia of Russian Aircraft 1875-1995* (London: Osprey Aerospace, 1996), pp. 257-58, 424-25; Zaloga, *Target America*, pp. 81-88.

30. Kantemirov, "The History of the Selection of the Design". Timothy Vainolomeyev, "Soviet Rocketry that Conquered Space: Part I. From First ICBM to Sputnik Launcher." *Spaceflight* 37 (August 1995): 260-63.

31. David Holloway, *Stalin and the Bomb* (New Haven, CT: Yale University Press, 1994), pp. 306-07. There has been some disagreement on whether this particular test was a true hydrogen bomb or merely a "boosted fission" weapon, but the Soviets themselves clearly viewed the test as a hydrogen bomb. As Holloway states, "It is to some degree, a matter of taste whether one calls it a thermonuclear weapon or a boosted weapon."

32. Sakharov, *Memoirs*, p. 180; Lardier, *L'Astronautique Soviétique*, p. 90.

I should *have* refused, pointing out that such things could not be decided in haste by a single scientist: they require more serious deliberation. But I had an idea which at the moment seemed promising (it later turned out to be neither very original nor successful). I had no one with whom to consult. I nevertheless wrote a report on the spot and gave it to Malyshev."

Based on Sakharov's report, Malyshev had the basic parameters for the mass and volume constraints for a next-generation thermonuclear payload. Armed with this information, he soon arranged a meeting at NII-88's OKB-I in October 1953 to discuss "future work," arriving alone without any assistants. Malyshev was unusually cheerful and animated during the meeting, which was attended by Korolev's inner circle, including his First Deputy Mishin. The engineers were quick to suspect that everything was not well. Malyshev casually inquired about the lifting capability of the ICBM, to which Sergey S. Kryukov, one of its designers, announced "about 3 tons." Malyshev firmly replied that the rocket must be able to lift six tons, at the very least five.³⁴ There was a brief moment of resistance from Korolev, but Malyshev would hear none of it. Later, Kryukov firmly told Korolev that this would simply not be possible given the current design of the missile. In the end, of course, the rocketry engineers capitulated, and they began a total overhaul of the design.

The new chairman of the Council of Ministers, Malenkov, sealed the decision to increase the payload at two meetings of the Presidium in late November 1953. The first one was attended not only by all the members of the Presidium, but also the key nuclear weapons scientists, including Sakharov. At this meeting, the attendees adopted an official Central Committee resolution to develop and explode Sakharov's new device by 1955. The second meeting was attended by missile administrators (most likely Ustinov, Ryabikov, and Pashkov) and set the specifications for the new ICBM so that it could carry Sakharov's thermonuclear device. Based on Malyshev's advice, Malenkov set the payload mass capability of the new vehicle between just over five and a half and six tons. In an ironic epilogue to the redesign, the new Sakharov bomb was never built and was replaced by a concept that was completely different." However, Sakharov's quick and hasty report significantly influenced the design of the world's first ICBM—a rocket that in its modern variants continued to loft Russian cosmonauts to the Mir space station into the late 1990s.

Work on the revised draft plan for the ICBM, by then named the R-7, or "product 8K71," began in the fall of 1953, culminating in a major meeting in January 1954 attended by all the major chief and deputy chief designers to discuss the changes in the missile.³⁶ The biggest challenge for Korolev's engineers was how to improve the lifting characteristics of the missile without any major changes in layout, which might delay the program even further. The most important factor was clearly propulsion. Preliminary calculations showed that Glushko's single-chamber LOX-kerosene RD-105 and RD-106 engines with thrust ranges of fifty to sixty tons would prove inadequate for the task of lifting a five-and-a-half-ton payload. The engines themselves were performing poorly during ground tests at OKB-456 because of burning instabilities

33. Sakharov, *Memorrs*, p. 180.

34. Golovanov, Korolev, pp. 473–74.

35. Sakharov, *Memoirs*, pp. 180–81; Lardier, *L'Astronautique Soviétique*, p. 90; Kantemirov, "The History of the Selection of the Design "

36. Mozhorin, et al., eds., *Nachalo kosmicheskoy ery*, p. 71. The chief designers included S. P. Korolev (NII-88 OKB-I), V. P. Barmin (GSKB SpetsMash), V. P. Glushko (OKB-456), B. M. Konoplev (NII-885), V. I. Kuznetsov (NII-10), and N. A. Pilyugin (NII-885). The deputy chief designers included M. I. Borisenko (NII-885), K. D. Bushuyev (NII-88 OKB-I), S. S. Kryukov (NII-88 OKB-I), and V. P. Mishin (NII-88 OKB-I). See Semenov, ed., *Raketno-Kosmicheskaya Korporatsiya*, p. 73.

in the combustion chambers, which led to high-frequency vibrations. Glushko's introduction of ribbed combustion chamber walls for cooling helped alleviate heating problems, but the engines had reached the physical upper limits of thrust. A way out of this quandary was offered by yet another idea tested by Chief Designer Isayev at NII-88. Using a single-chamber forty-ton-thrust engine, he had recently built and tested a multichamber engine that provided a cumulative thrust much higher than its single component. With Isayev's results in hand, Glushko could combine four combustion chambers together, all fed by the same turbopump. Although the unstable burning problem remained, its effects were drastically reduced because of the low thrust of each chamber. The advantages were numerous. Not only were performance values improved, but there also were considerable savings in engine mass compared to the thrust levels achieved. Furthermore, given that the chambers were identical, research and development, construction, and testing were simplified to a great extent. The engines that emerged from this redesign were the RD-107 and RD-108. One of each of the former, with a sea-level thrust of eighty-three tons, would be installed on the four lateral strap-ons. A single RD-108 with a sea-level thrust of seventy-five tons was earmarked for the central core. In March 1954, Glushko named Yuriy D. Solovyev, an engineer at his design bureau, to lead the design and construction of these engines."

A second redesign was related to the problem of steering during flight after the strap-ons had been discarded. The engineers had originally settled on using graphite steering rudders, such as those used on early missiles (for example, the German A-4), but further research proved that not only would they not tolerate high velocities and temperatures for long periods of time, they would deleteriously affect the configuration at the base of the missile. Korolev's First Deputy Mishin suggested the use of small steering engines firing off their own combustion chambers, which would be integrated into the main engines and use propellants diverted from the main turbopumps. Korolev had invited Glushko to develop these engines, but he refused outright, not only fearful of being diverted from his primary work on the main engines, but also because he believed that "it would be impossible to control a rocket by such thrusters." Mishin instead facilitated the transfer of a group of young engineers led by Mikhail V. Melnikov from Keldysh's NII-1 to OKB-1 for this project. Mishin's enthusiasm for the idea eventually resulted in the use of steering thrusters on not only the central block, but the four lateral blocks as well. Each lateral block had two verniers, while the central block had four, each with a thrust of two and a half tons, bringing the total number of combustion chambers firing at liftoff to thirty-two. In later years, when these vernier thrusters performed flawlessly, Glushko apparently asked Korolev if he could take over production of the motors. Not only did Korolev allow this, but he did not mind when Glushko changed his thinking and began building the verniers himself, taking full credit for their early development." These vernier engines had a remarkable history. They were used as the basis for upper stage engines for the Vostok, Soyuz, Molniya, N I, and Proton launch vehicles.

The development of an effective guidance system for the R-7 was a major problem for engineers. Because the missile would fly over a larger distance than any previous vehicle, an iner-

37 Peter Stache *Soviet Rockets* Foreign Technology Division Translation FTD ID(RS)T 0619 88 (from unnamed source) Wright Patterson Air Force Base Ohio November 29 1988 pp 299-302 This is a translation of Peter Stache *Sowjetischer Raketen* (Berlin Militärverlag der DDR 1987) Also see Varfolomeyev 'Soviet Rocketry that Conquered Space Part I' A Yu Ishlinskiy ed *Akademik S P Korolev uchenyy inzhener chelovek* (Moscow Nauka 1986) p 270 V P Mishin 'Problems of the First Flight of a Man into Space' (English title) in *Chagarinskiye nauchnyye chteniya po kosmonavtike i aviatsii* (Moscow Nauka 1991), p 21

38 Vasilii P Mishin "He Said 'Here We Go!'" (English title) *Aviatsiya i kosmonavtika* no 4 (April 1991) 13-14 Chertok *Rakety i lyudi* pp 394-95 Ishlinskiy ed *Akademik S P Korolev* pp 208-09

39 Mozzhorin et al eds *Nachalo kosmicheskoy ery* p 79 Korolev drew up the production instructions for the vernier thrusters on August 7 1954 See Biryukov "Materials from the Biographical Chronicles" p 233

tial guidance system such as that installed on the German A-4 would be woefully inadequate because of gross inaccuracies symptomatic of the technology of the time. Korolev proposed the development of both radio and autonomous guidance systems for the first ICBM.⁴⁰ Eventually, the system chosen was a combination of both. After liftoff, a complex set of inertial guidance systems would maintain angular stability, apparent velocity, and synchronization of propellant consumption at nominal levels. At about twenty to thirty seconds prior to core engine cutoff, the four small verniers on the central block would be fired into operation, after which the radio control system would be switched on to manually control deviations from the desired trajectory.⁴¹ Both guidance systems were developed by NII-885—the radio-controlled portions led by Chief Designer Ryazanskiy and the inertial part led by Chief Designer Pilyugin. The development of precisely calibrated gyroscopes for the instrumentation was the responsibility of Chief Designer Kuznetsov of NII-10. All three were original members of the Council of Chief Designers.

The missile itself looked unlike anything created before. At launch, the four conical strap-ons (Bloks B, V, G and D), each just over nineteen meters in length, surrounded the center hammerhead-shaped core (Blok A), itself 26 meters long. The lateral boosters, each containing about forty tons of propellant, tapered up to a point at the top and were connected by ball-and-socket joints to the core at the apex and secured by tension bands at the bottom. With the four strap-ons, the total base diameter was more than ten meters, and the total length of the missile was thirty-three meters. The launch mass was 270 tons, of which about 247 tons was propellant. At liftoff, the total thrust was 398 tons. After launch, at an altitude of fifty kilometers and about 100 kilometers from the launch site, shortly prior to propellant cutoff, pyrotechnical devices would loosen the tension bands at the base of the vehicle, which connected the four exterior blocks to the core. With the four strap-ons still firing, albeit at much lower thrust by then, the lateral blocks would by their natural force move away from the central block, rotating upwards and away from the base. At a certain angle, the mountings at the apex of the four blocks would automatically release. Oxygen valves would also automatically open to exert gentle pressure on the strap-ons to move them independently away from the core. The core stage (called the second stage by the Soviets) would continue to operate until reaching an altitude of 170 kilometers and a range of 700 kilometers, at which point engine cutoff would occur. For the remaining portion of the flight, the payload would coast on a ballistic trajectory until reentry.⁴²

One of the most expensive and time-consuming aspects in the development of the R-7 was the design of a launch structure to accommodate the unwieldy looking missile. Originally, the plan was to assemble the missile at the launch pad in a vertical position. At least three preliminary designs for the launch pad, based on this option, were prepared between September and December 1954.⁴³ All three plans used a single load-carrying platform with four circumferential and central supports for the five boosters on the missile, restrained by a variety of weights, levers, and spring mechanisms. All the plans, however, proved unwieldy because of concerns about damaging the missile itself at takeoff. It was at this point that Mishin emerged with an original idea for a launch pad. The conception involved assembling the booster horizontally in a hangar and then transporting the rocket to the launch pad, where it would be raised into a vertical position. At the pad, the R-7 would be suspended at "the waist" above its center of

40. Mozzhorin, et al., eds., *Nachalo kosmicheskoy ery*, p. 282.

41. Varfolomeyev, "Soviet Rocketry that Conquered Space: Part I"; Zaloga, *Target America*, p. 141; B. Pokrovskiy, "Chief Designer of Radio Control Systems" (English title), *Krylia rodiny* no. 4 (April 1989): 44-45.

42. Stache, *Soviet Rockets*, pp. 296-98, 307; Mozzhorin, et al., eds., *Nachalo kosmicheskoy ery*, p. 74; G. A. Kustova, ed., *Ot pervogo Sputnika do "Energii": "Burana" i "Mira"* (Kaliningrad: RKK Energiya, 1994), p. 35.

OKB-I engineer S. P. Parmuzin invented the ingenious separation mechanism for the exterior blocks of the R-7.

43. Mozzhorin, et al., eds., *Nachalo kosmicheskoy ery*, pp. 116-17.

gravity, about twenty meters from the base, by four identical and huge "petals." Chief Designer Barmin, who was responsible for the design of launch complexes, later recalled:

The heavy rocket "hangs" on them [the "petals"] until its engines go into primary thrust mode. And then they pull away to the side simultaneously, and the gas blasts from all the operating engines exit in one large opening and escape the steppe through a special concrete conduit.⁴⁴

The petals would swing into motion not by any external hydraulic power, but by an ingenious system of counterbalanced weights that worked because of gravity. The engineers nicknamed the system *Tyulpan* ("tulip") because of the peeling nature of the petals at launch time. Each of the petals would contain work gantries and other systems required to fuel and test the rocket prior to launch. In late 1955, a commission headed by Academician Blagonravov, a mechanical engineer himself, reviewed this revolutionary idea. While generally supportive of the idea, the commission recommended that the system could be improved by making the petals swing gantries work on hydraulics rather than by gravity. Korolev also weighed in with the nongravitational option. Barmin did not budge from his position, arguing that there was no redundancy required for "God's powers." Korolev eventually gave in, but he added that "should anything go wrong, you will be liable with your life."⁴⁵ On September 22, 1955, the commission approved the launch pad complex for full-scale construction led by Barmin's CSKB SpetsMash organization.⁴⁶ Korolev did not need to have had any doubts. For more than forty years, Mishin's original conception has serviced the space program; it was from the same type of launch pad that cosmonauts flew to the *Mir* space station from 1986 to 1999.

In February 1954, the primary participants of the work on the R-7 finally agreed to the revised conception of the ICBM, clearing the way for governmental intervention. On May 20, 1954, the USSR Council of Ministers issued an official decree calling for the development of the two-stage 8K71 R-7 ICBM. A second decree a month later on June 28 added clarifications to the schedule for the development of the rocket. Finally, by order of Minister of Defense Industries Ustinov on July 6, the Soviet government elevated the development of the ICBM to a level of "state importance."⁴⁷ The same

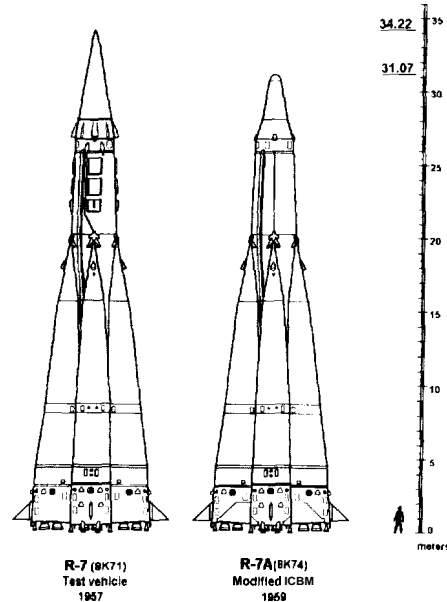

The Soviet R 7 ICBM The left diagram is the original variant of the missile the 8K71 as it was flown in 1957 The later operational version the R 7A or 8K74, is shown on the right (copyright Peter Gorin)

44 B Konovalov 'Lessons of the First Satellite' (English title) *Izvestiya* September 29 1987 p 3

45 Boris Khibrikov 'Vladimir Barmin One of the Top Six Designers' *Aerospace Journal* no 2 (March-April 1997) 81-83 Mozzhorin et al eds *Nachalo kosmicheskoy ery* p 117

46 Mozzhorin et al eds *Nachalo kosmicheskoy ery* p 117

47 Semenov ed *Raketno Kosmicheskaya Korporatsiya* p 74 Sergeyev ed *Khronika osnovnykh sobyitiy istorii* p 35 Golovanov Korolev p 475 "TsNIIMash—One of the Leading Space Branches" (English title) *Novosti kosmonavtiki* no 6 (March 15-28 1993) 26-28 Note that in the last source the missile is referred to as the R 6 and not the R 7

month, on July 24, NII-88's OKB-I completed the draft plan for the rocket, which spanned a total of fifteen volumes of technical documentation. Unwilling to commit to something that might prove to be a colossal waste of money, the Soviet government established an "Expert Commission" of independent scientists and engineers to study the draft plan and recommend a course of action. Headed by Academician Keldysh, this commission consisted of aeronautical engineers, mathematicians, gas dynamics specialists, propulsion experts, and military officers. Their evaluations were overwhelmingly positive, clearing the way for full-scale industrial work on the ICBM. On November 20, 1954, in an unusual move, the USSR Council of Ministers officially approved the draft plan for the R-7 missile—a decision that normally would have been left in the hands of engineers or scientists.⁴⁸

The individuals who worked on the R-7 began to affectionately call the missile *semerka*, the Russian expression roughly equivalent to "old number seven," and it was a nickname that has remained with the vehicle for more than forty years. Although all of the leading engineers at NII-88's OKB-I, such as Bushuyev, Voskresenskiy, Okhapkin, Chertok, and Kryukov, were involved in its design, it was perhaps Mishin more than any other individual who shaped its look. Many years later, when a noted Soviet journalist asked numerous veterans of the organization who besides Korolev contributed more to the emergence of the R-7, most replied, "This was, of course, Mishin's rocket."⁴⁹ Once the documentation and design had been completed, Korolev assigned one of his middle-level engineers, thirty-five-year-old Dmitriy I. Kozlov, the man who had encouraged Korolev to join the Communist Party a few years earlier, to oversee its creation as the "lead designer" of the missile.⁵⁰ Kozlov had already served in the same capacity for the R-5 missile. A total of 200 institutes and design bureaus within twenty-five ministries were engaged in the project, which, save for the development of nuclear weapons, was perhaps the largest military project undertaken in the Soviet Union up to that point.

The May 1954 decree also specified at least two other items. The first was the official assignment to develop intercontinental winged cruise missiles to design bureaus within the Ministry of Aviation Industry. Lavochkin's OKB-301 would design and develop the La-350 Burya, while Myasishchev's OKB-23 would do the same for the M-40 Buran. Finally, the decree called for the selection of a new firing range for the R-7 ICBM.⁵¹

At the outset, the planners realized that the location and facilities at the State Central Range No. 4 at Kapustin Yar would be inadequate for the mammoth requirements of the new rocket. A major concern was the proximity of the Kapustin Yar site to radar stations operated by U.S. intelligence services in Turkey. In late 1953, Ustinov, Nedelin, Korolev, and other leaders of the rocketry industry had authored a letter to the USSR Council of Ministers containing the requirements for such a site. The following year, Nedelin appointed Maj. General Vasily I. Voznyuk, the commander of Kapustin Yar, to head a special commission to select an

48. M. V. Keldysh, ed., *Tuoreheskoyenasledrye Akademrka Sergeya Pavlovicha Koroleva izbrannyye trudy i dokumenty* (Moscow: Nauka, 1980), p. 398; Golovanov, Korolev, p. 475; Biryukov, "Materials from the Biographical Chronicles," p. 233; Yu. V. Biryukov and A. A. Yerenenko, "50 Years for the Native Rocket-Space Industry. The Early Period of Development" (English title), *Novosti kosmonautiki* no. 10 (May 6-19, 1996): 54-64; Semenov, ed., *Raketno-Kosmicheskaya Korporatsiya*, p. 75. The individuals on the R-7 "Expert Commission" included M. V. Keldysh (NII-1), A. A. Dorodnitsyn (TsAGI), S. A. Lavochkin (OKB-301), A. M. Lyulka (OKB-165), A. I. Makarevskiy (TsAGI), A. C. Mrykin (UZKA), B. N. Petrov (Institute of Control Problems AN SSSR), Kh. A. Rakhmatulin (MVTU), N. N. Smirnitkiy (CURVO), B. S. Stechkin (OKB-300), C. A. Tyulin (NII-4), and A. P. Vanichev.

49. Golovanov, Korolev, p. 502.

50. Aleksandr Romanov, *Korolev* (Moscow: Molodaya gvardiya, 1996), pp. 257-58, 272; V. Drebkova, "General Designer D. I. Kozlov—75 Years" (English title), *Novosti kosmonautiki* no. 20 (September 24-October 7, 1994): 56.

51. Afanasyev, "Without the Secret Stamp", Jacques Villain, ed., *Baikonour la porte des etoiles* (Paris: Armand Colin, 1994), p. 47.

alternative launch site. Perhaps to draw out an impartial verdict. Nedelin told Voznyuk that "you'll be the chief of the new test range, so make the selection to suit yourself."⁵² Chief Designers Korolev, Barmin, and Ryazanskiy were the leading engineering representatives on the commission. Barmin was to advise on launch complex requirements, and Ryazanskiy was on hand to make recommendations on the placement of radio stations to control the R-7. Tikhonravov's team at NII-4 also provided supplementary data for the selection. At the end of the year, the Voznyuk commission emerged with three competitive sites:

- A location in the Yochkar-Orla region in Mordoviya (in the Mari region), where there were large clear spaces and room for more because of a vigorous lumber industry
- A location near Makhachkala (in Dagestan) on the shores of the Caspian Sea so discarded lower stages could fall into the sea
- The semi-arid Kzyl-Orda region (in the Kazakhstan Soviet Socialist Republic) near the Syr Darya River"

One of the major requirements for the new site was that radio tracking stations be located on either side of the ICBM's trajectory, and this specification eventually eliminated the first two choices, leaving the Kazakhstan site, which was formally selected by USSR Minister of Defense Georgiy K. Zhukov. Ironically, by the time that the Voznyuk commission finally decided on the site, the criterion for radio station placement, which had supported the Kazakhstan choice, was invalidated by some ground-breaking work by Chief Designers Ryazanskiy and Konoplev. The members of the commission were apparently too afraid of Zhukov to inform him that the reason for selecting Kazakhstan had been neutralized.⁵⁴ In the end, the commission touted six major advantages of the new site:

- It was far enough from Soviet borders to conduct work in secret.
- The weather was acceptable for launches during at least 300 days of the year.
- The presence of vast areas of desert nearby was useful for dropping stages.
- Radio guidance for the R-7 could be conducted by two stations, which could be constructed 500 kilometers from the launch pad.
- The site was on the railway line between Moscow and Tashkent on the Syr-Darya River for bringing materials to the range.
- The site had the advantage of being located close to the equator, thus imparting the highest possible velocity to airborne payloads."

Marshal Nedelin assigned the mammoth task of directing the design, layout, and construction of the new launch range to the Chief Directorate of Special Construction of the USSR

52 Mozzhorin, *et al.*, eds., *Nachalo kosmicheskoy ery*, p. 129; Romanov, Korolev, p. 248 The actual Council of Ministers decree for the selection of a launch range was issued on March 17, 1954. The selection commission was obliged to report on its decision by January 1, 1955. See K. V. Cerchik, ed., *Nezabyuyemyy Baykonur* (Moscow: Interregional Council of Veterans of the Baykonur Cosmodrome, 1998), pp. 21-22.

53 Konovalov, "Lessons of the First Satellite"; Colovanov, Korolev, pp. 481-82; Mozzhorin, *et al.*, eds., *Dorogi v kosmos I*, 175-76; Mozzhorin, *et al.*, eds., *Nachalo kosmicheskoy ery*, pp. 56-57 There may also have been a fourth final choice, the village of Kharabol in the Astrakhan region. See Chertok, *Rakety i lyudi*, p. 407. For a mention of Tikhonravov's contribution to the selection of the launch range, see I. K. Bazhinov, "The Activities of M. K. Tikhonravov in 1950-1956 in the Sphere of Researching the Basic Problems of the Creation of ISZs" (English title), *Iz istorii aviatsii i kosmonavтики* 42 (1980), 39-45.

54 Mozzhorin, *et al.*, eds., *Nachalo kosmicheskoy ery*, p. 76.

55 Jacques Villain, "A Brief History of Baikonur," presented at the 45th Congress of the International Astronautical Federation, IAA-94-IAA.2.1 614, Jerusalem, Israel, October 9-14, 1994; Villain, ed., *Baikonour*, p. 46.

Ministry of Defense. The primary task of coordinating the entire effort fell on the shoulders of a fifty-one-year-old colonel named Georgiy M. Shubnikov. For architectural and structural expertise, the Central Planning Institute No. 31 of the Ministry of Defense established a group under the tutelage of army Lt. Colonel Aleksey A. Nitochkin, who, like Shubnikov, was a veteran of World War II when he had helped build military fortifications.⁵⁶ It was these two individuals who perhaps contributed more than anyone else in bringing the project to fruition during the ensuing two years.

The USSR Council of Ministers signed a decree (no. 292-181), dated February 12, 1955, that officially sanctioned the creation of a new launch range for the R-7 ICBM and subsequent generations of new missiles in Kazakhstan. The decree authorized 586 soldiers and 325 blue- and white-collar employees to be initially assigned to the test area, officially designated the Scientific-Research and Testing Range No. 5 (NIIP-5). The first group of thirty blue-collar workers, led by a twenty-three-year-old lieutenant in the Soviet army, Igor I. Denezhkin, had already arrived at the projected site exactly a month earlier, on January 12, to prepare for actual construction workers.⁵⁷ Marshal Nedelin had an unusual choice for the commander of NIIP-5. He was a man who had crossed Korolev's path in the early 1950s by authoring a letter critical of the early ballistic missile effort to Beriya himself. Maj. General Aleksey I. Nesterenko, at the time forty-eight years old, had been fired as director of NII-4 in 1950 and spent the next four years as a head of the "rocketry faculty" at the F. E. Dzhherzhinskiy Military Academy in Moscow. Perhaps his appointment was a not so subtle move to have a range commander who would not capitulate in the face of Korolev's juggernaut personality.

Nesterenko arrived at NIIP-5 three months after his formal appointment on March 19, 1955, in the company of Nedelin himself. His first impressions of the place were not encouraging:

We flew into Dzhusaly, disembarked from the aircraft, and were instantly buffeted by a hot wind, and with the temperature above 45 degrees [Centigrade] it was like walking into a blazing furnace. When we arrived at the construction site, our hearts sank: there was nothing but naked steppe, not a tree in sight, with only piles of sand and an assortment of animals scattered across the countryside.⁵⁸

As inhospitable as Kapustin Yar was, those who transferred to NIIP-5 from the former test range must have wondered whether they were not leaving one part of hell for another. The closest town to the site was named Tyura-Tam, a small settlement of local Kazakhs, which prior to 1955 was "a couple of two-story houses for the railwaymen, a couple of dozen small mud-plastered houses, and the tents of geologists prospecting for oil."⁵⁹ Tyura-Tam itself was an isolated railway stop on the important Moscow-Tashkent line; earlier in the century, a British mining company had apparently ran a station not far northeast of the town. The tsars had also used the location as a place of exile for undesirable citizens. In the late nineteenth century, Nikifor Nikitin was banished here for "his seditious plans for a flight to the Moon." The judge

56. Mozhhorin, et al., eds., *Nachalo kosmicheskoy ery*, pp. 177-79; Golovanov, *Korolev*, pp. 482-85. The directorate's chief engineer at the time was Lt. General M. G. Grigorenko.

57. M. Rebrov, "Chief of the Cosmodrome: The Time Has Come to Tell" (English title), *Krasnaya zvezda*, September 18, 1990, p. 2; Yu. P. Maksimov, ed., *Raketnyye voyska strategicheskogo naznacheniya: voyenno-istoricheskii trud* (Moscow: RVSNI, 1992), p. 42; Ivan Borisenko and Alexander Romanov, *Where All Roads into Space Begin* (Moscow: Progress Publishers, 1982), p. 14; Council of Veterans of the Baykonur Cosmodrome, *Proryv u kosmos: ocherki ob ispitatelyakh spetsialistakh i stroitelyakh kosmodroma Baykonur* (Moscow: TOO Veles, 1994), p. 5; Villain, ed., *Baikonour*, p. 48.

58. Mozhhorin, et al., eds., *Nachalo kosmicheskoy ery*, p. 146.

59. Borisenko and Romanov, *Where All Roads into Space Begin*, p. 33.

apparently believed that work in the local copper mines would knock some sense into the hapless individual."

Shubnikov, the chief engineer for the construction project, arrived at Tyura-Tam on March 5 with a host of important individuals, including a "political commissar." The first cubic meter of concrete was poured in April in support of building a highway from the initial troop settlement to the location of the actual launch pad. Finally, on May 5, 1955, the foundation stone was set at the living settlement at site 10, henceforth called Zarya, following which Shubnikov gave a short inspirational speech to the attendant workers and soldiers on the hard work still to be done within the following two years. A General Staff directive dated June 2 from the Ministry of Defense called for the formation of a complex organizational structure at NIIP-5, and it is this date that was henceforth commemorated as the birthday of the launch site."

Under the coordination of Shubnikov, Nitochkin, Nesterenko, and Chief Designer Barmin, construction at NIIP-5 was facilitated at an unusually accelerated pace. The first concrete houses at Zarya were finished by September 1955. At the time, a twenty-kilometer-long road due north from Zarya was marked out, which led to the actual location of the projected launch pad of the R-7 ICBM. The area was named site 1, a designation that it still holds to this day. The actual location of the launch pad was determined by Nedelin's requirement that the facility be located within thirty kilometers of the residential area, but out of visual range of any passing trains." A network of railway lines, which connected the major areas of the range, primarily to transport supplies and the rocket itself, was completed by early November. This work was by no means easy. As one veteran recalled many years later:

All the desert offered was a thin layer of clay which disintegrated into dust after a lorry had passed over it a couple of times. Deep dust-filled ruts were formed. The lorries would grind to a halt in them, often scratching their chassis. A thick cloud of dust hung all over the area, filling nose, eyes and ears. Cars crawled at a snail's pace. The dust permeated food, bread and petrol and . . . a cloud could be seen from a distance of 20 to 30 kilometers.⁶³

As at Kapustin Yar, the workers once again had to face a wide range of unpleasant temperatures. Although construction was started in mid-1955 to take advantage of the long summers, by the end of the year, the workers were treated to the reality of minus forty-two degrees Centigrade temperatures with winds of cyclone forces. Work in fact had to be abandoned on December 26 on a particularly harsh night, significantly delaying construction efforts. When the work resumed, it was primarily on a system of water pipes in preparation for building the actual launch pad in 1956.

Although workers began initial construction of the foundation of the launch complex in August 1955, the pad was not the primary focus of the work at NIIP-5 until early 1956. Between January and March of that year, about 15,000 cubic meters of earth were displaced per day at site 1. This was in preparation for pouring concrete for the giant launch pad structure, which began on April 19 an hour before midnight in front of about 300 people who were present to witness the event." The 250-by-100-by-forty-five-meter launch platform took almost five

60 *Ibid* p 32 The account of Nikitin's sentence was printed in an issue of *Moskovskiy gubernskiy novosti* (Moscow Provincial News) in 1878

61 Villain ed *Barkonour* pp 48-49 Borisenko and Romanov *Where All Roads into Space Begin* pp 14-17 Stache *Soviet Rockets* pp 310-11 Council of Veterans of the Baykonur Cosmodrome *Proryv v kosmos* p 89 In official documentation Zarya was named Tashkent 50 no doubt to disguise its real location

62 Lardier *L'Astronautique Soviétique* p 91 Mozhorin *et al* eds *Nachalo kosmicheskoy ery* p 132

63 Borisenko and Romanov *Where All Roads into Space Begin* p 33

64 *Ibid* p 58 Villain ed *Barkonour* pp 53-54 Lardier *L'Astronautique Soviétique* p 91

months to complete and used 30,000 cubic meters of concrete. Finally, on October 5, the workers completed the road and railway system from Zarya to site 1.

The engineers responsible for the design and construction of the launch pad were remarkably cautious in their efforts, and prior to work at Tyura-Tam, they had expended a huge amount of effort to duplicate the entire structure at a plant in Leningrad to eliminate any potential defects. Every single element of the launch pad was constructed and assembled over a nineteen-meter-diameter pit in a special building at the Leningrad Metallurgical Plant, and a full-scale test version of the R-7 was installed in the facility and loaded with water instead of propellant to simulate the expected loads." Not only was the missile tested for potential wind effects, but a special lifting beam was used to raise the 100-ton rocket off the "launch pad" at the plant to simulate a liftoff and observe the dynamics of the launch. Yevgeniy V. Shabarov and Anatoliy P. Abramov, two engineers from OKB-1 in their mid-thirties, were tasked by Korolev to head the work at the plant, although, as was usual for Korolev, he kept close tabs on the work with daily reports. Notorious for exploding into rages of censure, Korolev did not spare any effort to make sure that the work remained on schedule. As Abramov wrote years later:

Once we reported that a mistake had been committed on the job . . . he [Korolev] reacted furiously, verbally ground us into dust, called us imbeciles, and promised to have us dismissed. At first we were upset, but then we began to laugh hysterically to release our pent-up stress. It was not the first time that this had happened. *Korolev's* diatribes were the stuff of legend, and he was a master at it; his eyes would flash, his words would destroy yours, he would threaten to send you home walking between the railway tracks. *tell* you to go work at the boiler shop or at the "wood-mill " But we all knew that these were just words. Nobody was dismissed, and no one took offense. And although people admitted to being afraid of him, they respected him just the *same*.⁶⁵

For this and other work, both Abramov and Shabarov were rewarded well, and both in fact later went on to become key deputy chief designers at OKB-1.

The tests at the Leningrad plant were conducted between May and August 1956, and much to the relief of the engineers, both from OKB-1 and GSKB SpetsMash, they were all uniformly successful. The structure was then disassembled and shipped in October to Tyura-Tam for assembly at site 1. Not far from this site, at site 2, a gigantic building designated the Assembly-Testing Building was constructed for assembly of the R-7. With dimensions of 100 by fifty by twenty meters, it was one of the largest buildings in the world at the time, and it continues to serve as the primary assembly point for many R-7-derived launchers to this day. Preparations for the first launches were not limited to the Leningrad plant. The extensive testing stands at NII-88's Branch No. 2 at Zagorsk served as the site of a number of important tests in support of the R-7. These included tests of propellant loading, booster separation systems, and engine firings. Engineers built three static test stands for the core block, three for the strap-ons, and two for the complete R-7 at Zagorsk. The initial ground tests of the engines had begun as early as mid-1955 in the form of experimental single-chamber versions of the main engines. A step-by-step process led to the use of two combined chambers and eventually full-scale four-chamber versions in January 1956. Within seven months, engineers were able to test-fire the full core block with the RD-108 engine for periods of twenty seconds. This led up to firings simulating a full cycle of flight. A major accident occurred at Zagorsk during a refueling exercise

⁶⁵ Mozhgorin, et al., eds., *Dorogr v kosmos. I*, p. 175. On page 52 of this source, it is stated that Chief Designer Barmin recalls that potassium bichromate was used instead of water

⁶⁶ Mozhgorin et al., eds., *Nachalo kosmicheskoy ery*, p. 14

when a feeding pipe supplying liquid oxygen to the central block broke because of "hydro-shock." An extensive series of repairs and a major redesign effort ensued to preclude such a dangerous incident.⁶⁷

OKB-1 engineers also launched a number of experimental missiles from Kapustin Yar during 1955-56 to test a variety of systems crucial to the operation of the R-7 missile. Original concepts of a radio control system for the ICBM were used on the R-2R missile during launches in January 1955.⁶⁸ Later tests used modifications of the original R-5M missile by replacing the nuclear warhead with large instrumentation containers. Between May 15 and June 15, 1956, three of the R-5R missiles were launched, the very first Soviet ballistic missiles using radio guidance. The flights utilized a series of ground stations, which served as prototypes for stations being constructed at NIIP-5 in support of R-7 operations. The experiments also studied the effects of jet plumes on radio wave propagation. All the launches were successful.⁶⁹

A second experimental missile, the M-5RD, also a modification of the R-5M, was launched in two separate series of five launches each between February and August 1956.⁷⁰ These launches focused on perfecting three major systems in the R-7: a guidance system for the Adjustment of Apparent Velocity (RKS), a control system for Normal and Lateral Stabilization (NS and BS), and an electro-mechanical system for the Simultaneous Emptying of Tanks (SOBIS), the last being a test for propellant feeding from the lateral blocks on the ICBM. Once again, all the launches were successful, and laying to rest a number of concerns that had troubled the R-7 designers.

As is true of any large-scale missile program, the work expended on supporting infrastructure and supplementary systems far outweighed the actual amount of effort on the missile itself. Apart from the construction of the launch site at Tyura-Tam, the launches of experimental missiles from Kapustin Yar, the testing of engines at Zagorsk, and the creation of a simulated launch structure at Leningrad, there were numerous other elements that contributed significantly to the success of the program. These included the development of a nationwide ground telemetry system—a tracking and command network that was directed by the military NII-4 entity under the management of institute Deputy Director Yuriy A. Mozzhorin. This thirty-five-year-old artillery forces colonel, as a result of his remarkable success in this particular job, earned himself a bright and powerful role in the future Soviet space program. "From designers to military officers to industrial administrators, the individuals who made noteworthy contributions to the creation and development of the R-7 would emerge quickly in important positions during the space era. There was, of course, no hint of a space program in 1954 when work on the R-7 began, but within two years, the state of affairs took a dramatic turn—one that for the first time in history shifted the focus of much of the work of hundreds of organizations from building rockets to launching satellites into space.

67. *Ibid.*, p. 54; Varfolomeyev, "Soviet Rocketry that Conquered Space Part I."

68. Biryukov, "Materials from the Biographical Chronicles," p. 234; Mozzhorin, *et al.*, eds., *Nachalo kosmicheskoy ery*, pp. 280-81. Details on the R-2R are still lacking, although it is known that the radio control system was designed by Chief Designer B. M. Konoplev, who was at NII-20 until 1955, when he was transferred to NII-885.

69. Mozzhorin, *et al.*, eds., *Nachalo kosmicheskoy ery*, pp. 53, 282; Chertok, *Rakety i lyudi*, p. 404. The first launch date may have been May 31.

70. Mozzhorin, *et al.*, eds., *Nachalo kosmicheskoy ery*, p. 53. The first series was conducted between February 16 and March 23, 1956, while the second series was carried out between July 20 and August 18, 1956.

71. *Ibid.*, pp. 76, 169; Chertok, *Rakety i lyudi*, p. 406.

72. A. A. Maksimov, "People of Science. A Veteran of the Space Program" (English title), *Zemlya i uselenaya* no. 6 (November-December, 1990), 30-31; Mozzhorin, *et al.*, eds., *Dorogi v kosmos* 1, p. 158.

A Report on an Artificial Satellite of Earth

Mikhail K. Tikhonravov's team at NII-4 laid the conceptual foundation for concrete work on the first Soviet ICBM. At the same time, he had quietly begun research work on many of the scientific and technical questions associated with the development of artificial Earth satellites. By the time that work on the ICBM moved into high gear at NII-88 in 1953, Tikhonravov's team members had already abandoned work on multistage rockets, instead shifting their thematic focus exclusively to research on satellites. One of the earliest was started in 1952, when the group studied methods of dissipating heat and cooling an object reentering Earth's atmosphere from orbit. Later, the NII-4 group had continued to conduct "unofficial" research into satellites in general, and it produced three important memoranda in 1952-53 and early 1954, which answered a number of important questions required for the creation of a satellite:

- What kind of satellites could be launched by the early version of Korolev's R-7?
- What kind of equipment could be placed in them?
- How were they to be controlled with special orientation systems?
- What problems could they solve, no doubt including both scientific and military goals?"

At Korolev's prompting, Tikhonravov himself played an important role in moving his work to "official" status. Armed with two large sketchbooks, he made an appointment to meet Georgiy N. Pashkov, the missile department chief at the Ministry of Medium Machine Building. One of the books contained a huge number of clippings from the Western press with descriptions of American "plans" for artificial satellites. The other sketchbook contained detailed drawings and calculations proving that not only was such a launch within the grasp of Soviet technology, but that if given approval, any Soviet satellite would be ten times more heavy than an American one.⁷⁴ Pashkov was sufficiently impressed by Tikhonravov's presentation to telephone Marshal Aleksandr M. Vasiliyevskiy, the former Minister of Defense who was at the time a deputy in the ministry, to permit some modest but official support for Tikhonravov's work. Subsequently, a two-year dedicated scientific research program on the creation of an artificial satellite was approved on September 16, 1953, the first official effort in the Soviet Union on such a topic."

Tikhonravov's group, composed mostly of the same individuals who had participated in his earlier ICBM studies, such as Bazhinov, Maksimov, Soldatova, and Yatsunskiy, coordinated the satellite work closely with Korolev, although the two did not have any formal institutional connections. Korolev also consulted with Academician Keldysh to undertake parallel studies at his Department of Applied Mathematics of the V. A. Steklov Mathematics Institute. The same young scientists at the department who had provided much of the brain power for the design of the ICBM thus began a new effort to solve the problems involved in the "ballistic return of a space apparatus from Earth orbit and to show the possibility of using this method of

73 I. M. Yatsunskiy. "On The Activities of M. K. Tikhonravov in the Period From 1947 to 1953 on Substantiating the Possibility of Creation of Composite Missiles" (English title). *Iz istorii aviatsii i kosmonavtiki* 42 (1980) 31-38. An English translation of this can be found as I. M. Yatsunsky, "The Role of Mikhail Klavdijevich Tikhonravov in Creating Stage Rockets, 1947-1953," in John Becklake, ed., *History of Rocketry and Astronautics*, Vol. 17 (San Diego: American Astronautical Association Publications, 1995), pp. 451-56. See also Bazhinov, "The Activities of M. K. Tikhonravov 1950-1956."

74 Nikolay Dornbkovskiy. "October - April - Universe" (English title). *Sovetskaya rossiya*, April 12, 1989, p. 3. Pashkov recalls that the visit occurred in 1954, but it seems more likely that the meeting took place in late 1953.

75 Valeriy Baberdin. "The Once Secret Space NII Will Now Bear the Name of Tikhonravov" (English title). *Krasnaya zvezda*, January 18 1996, p. 6; Yatsunskiy. "On the Activities of M. K. Tikhonravov": Ishlinskiy, ed., *Akademyk S. P. Korolev*, p. 445



Mikhail Tikhonravov's famous "satellite team" shown here in a photo from 1970. It was during 1950-54 that these young men and women developed the first engineering conceptions of a Soviet Earth satellite. Based on this important research, Tikhonravov authored a landmark report on artificial satellites in 1954 that laid the groundwork for the early Soviet space program. Sitting from left are Vladimir Chalkovskiy, Gleb Maksimov, Lidiya Soldatova, Tikhonravov, and Igor Yatsunskiy. Standing from left to right are Grigoriy Moskalenko, Oleg Gurko, and Igor Bazhinov. (files of Asif Siddiqi)

returning on piloted flights."⁷⁶ Although these studies were not intended to support actual launches, they were giant steps forward for Korolev and Tikhonravov, for they underscored that the climate for space research was becoming more favorable. Tikhonravov's two-year research project consisted of a ten-point program to study the feasibility of launching artificial satellites. The ten topics studied were:

Development of practical methods for computing optimal trajectories for inserting satellites into orbit

- Effects of external factors on lowering orbits of satellites
- Effects of incorrect orbital insertion on the operation of satellites
- Analysis of using solar energy on satellites
- Analysis of orienting satellites in orbit
- Preliminary conceptions of unoriented and oriented satellites
- Research on observing the motion of launch vehicles and satellites during orbital insertion and later
- Analysis of regulating heat within satellites
- Analysis of the dangers of meteorite impact on satellites in Earth orbit
- Analysis on the possibility of returning both automated and piloted capsules from Earth orbit, which included studies of trajectories, thermal protection, and so on⁷⁷

⁷⁶ V. S. Avduyevskiy and T. M. Eneyev, eds., *M. V. Keldysh irbrannyye trudy raketnaya tekhnika i kosmonavtika* (Moscow: Nauka, 1988), p. 9; Ishlinskiy, ed., *Akademiya S. P. Korolev*, p. 445.

⁷⁷ Bazhinov, *The Activities of M. K. Tikhonravov in 1950-1956*.

In late 1953, Korolev began to consolidate all the current work on space issues. While in earlier years he may have been reluctant to formally request the Soviet government to sanction some kind of space project, three factors played into his hands by the end of the year. First, the removal of Stalin and Beria from the political milieu earlier in 1953 allowed him to think of proposing such ideas to the higher leadership without fear of reprisals. Second, his ICBM was finally beginning to take shape, and it was all but given that the Soviet government would enthusiastically approve that program. Without an ICBM, he would not be able to launch any satellite. Finally, the major expansion of work on satellites under Tikhonravov would support his cause with solid scientific research. In December 1953, when he was preparing the decree on approving work on the R-7, Korolev inserted the following lines into the text:

We should organize at NII-88 a scientific-research department with the goal of working on problems [together with the Academy of Sciences] of flights to altitudes of 500 or more km, and also work on questions associated with the creation of an artificial satellite of the Earth and the study of interplanetary space with the aid of the [R-7].⁷⁸

In the seven years he had been a chief designer, it was Korolev's very first formal request to the government on a matter related to spaceflight. Clearly, he still had some doubts. As one Russian historian recalled, while the draft of the decree "was making its way to the top," mention of the satellite was crossed out."

Knowing that he could not go alone on this matter, in the following months, Korolev marshaled a vast amount of support for his satellite proposal, most significantly from the USSR Academy of Sciences. Korolev spoke with Academician Keldysh on January 23, 1954, to schedule a meeting between the scientists at NII-4 and the Department of Applied Mathematics, to coordinate the entire effort. Approximately two weeks later, on February 7, Korolev spoke for the first time to Minister of Defense Industries Ustinov on the satellite issue. "sounding his boss out" on a formal proposal. Ustinov was restrained but promised that he would review any document when it was on his desk. Korolev immediately telephoned Tikhonravov and asked him to prepare a formal proposal to launch a Soviet satellite. The document would be based on his team's extensive research work in 1953-54. With the "ball rolling," Tikhonravov and two of his principal aides, Yatsunskiy and Maksimov, prepared a rough draft, which was then passed on to Korolev, who consulted his principal deputies, Mishin and Bushuyev, to make amendments. Chief Designer Glushko, the only other "space fanatic" on the Council of Chief Designers, also offered comments.

The activity led to a major meeting on March 16 at the offices of Academician Keldysh at the Academy of Sciences. In attendance were scientists from the Department of Applied Mathematics and NII-4, as well as renowned Soviet scientists, including Academician Petr L. Kapitsa, the nuclear physicist." A draft version of the report was then typed up at the end of March, before Keldysh took the matter to Academy of Sciences President Aleksandr N. Nesmeyanov on April 24. Nesmeyanov promised full academy support for the proposal, significantly bolstering Korolev's case. Final revisions of the typed document were carried out on

78. Georgiy Stepanovich Vetrov. "The First Satellite Historical Limits" (English title). *Nouostr kosmonavtiki* 16 (July 28-August 10, 1997) 2-9; G. S. Vetrov. "The World's First Artificial Earth Satellite Was Launched Forty Years Ago" (English title). *Nauka i zhizn* no. 10 (October 1997) 2-5

79. James Harford. *Korolev How One Man Masterminded the Soviet Drive to Beat America to the Moon* (New York: John Wiley & Sons, 1997). p. 123

80. B. V. Raushenbakh, ed. *Materialy po istorii kosmicheskogo korabl "uostok"* (Moscow: Nauka, 1991), p. 209; Golovanov, *Korolev* p. 519. Also present were S. E. Khaykin, I. A. Kibel, astronomer B. V. Kukarin, and physicist S. N. Vernov. Vernov was closely involved in scientific suborbital launches in the 1940s and 1950s

May 13 during a meeting with Korolev, Tikhonravov, and two of "Keldysh's boys," Timur M. Eneyev and Vsevolod A. Yegorov. Having a final draft in their hands, Korolev and Tikhonravov then attended a formal ceremony of the Presidium of the Academy of Sciences on May 25, hosted by President Nesmeyanov to draw official support from the academy. The three-hour meeting ended with a fully approved plan. As Tikhonravov wrote later in his personal journal: "All has been signed . . . one may say that the first stage is finished."⁸¹

Concurrently with this activity at the academy, both Korolev and Tikhonravov had been busy convincing key officials in the military of the satellite idea. After all, there would be no satellite unless the military agreed to relinquish an ICBM for the job. Korolev had first approached NII-4 Deputy Director Maj. General Georgiy A. Tyulin, his old friend from the Germany days. The latter was not, however, particularly enthusiastic, and Korolev only agitated Tyulin more when he began to overtly pressure him to give his consent. Tikhonravov had more success; he successfully secured the support of Marshal Vasiliyevskiy, who, having read the report, wrote back with gusto: "Comrade Tikhonravov: If you have any problems, call me at any moment. . . ."⁸² Despite the rebuke from Tyulin, Korolev prepared three copies of Tikhonravov's report, each attached with a cover letter authored by himself and a set of translations of articles on satellites published in the West. He sent a set of each, two days after the academy meeting on May 27, 1954, to Ryabikov (a Deputy Minister of Medium Machine Building), Ustinov (the Minister of Defense Industries), and Pashkov (Ryabikov's department chief in charge of missiles).⁸³ Only seven days had passed since the R-7 ICBM project had been formally approved by the government. Clearly, Korolev was not about to waste any time.

Tikhonravov's document, remarkable even in the present day, was a *tour de force* of foresight in the mid-1950s. Classified top secret for thirty-seven years, it was finally published in its original form in 1991, just prior to the dissolution of the Soviet Union.⁸⁴ The memorandum, titled "A Report on an Artificial Satellite of the Earth," began:

At the present time there are real technological possibilities to achieve sufficient velocity with the use of powerful rockets for the creation of an artificial satellite of the Earth. Most realistic and feasible in the shortest time is the creation of an artificial Earth satellite composed of automatic instruments which will have scientific apparatus on the exterior, carry out radio communications with the Earth, and circle the Earth at a distance on the order of 170–1.110 kilometers from the surface. Such a capsule will be the Simplest Satellite."

The complete report was divided into two broad thematic sections—one focused on immediate objectives of a space program and one focused on long-term goals. The immediate goals were to:

⁸¹ Ibrd

⁸² Colovanov *Korolev* p. 519

⁸³ Raushenbakh ed. *Materialy po istorii kosmicheskogo* p. 209 Colovanov *Korolev* p. 519 Ishlinskiy ed. *Akademiki S. P. Korolev* p. 445 Biryukov "Materials from the Biographical Chronicles" p. 233 Although Ryabikov was officially a Deputy Minister of Special Machine Building, he was simultaneously the chief of GlavSpetsMash ("Chief Directorate of Special Machine Building") within the Ministry of Medium Machine Building, which oversaw missile programs. Pashkov's official position was head of GlavTransMash within the Ministry of Medium Machine Building. Note that sources differ on the date the document was sent to Ustinov, with both May 26 and May 27, 1954, quoted widely.

⁸⁴ The entire document is reproduced as M. K. Tikhonravov, "A Report on an Artificial Satellite of the Earth" (English title) in Raushenbakh ed. *Materialy po istorii kosmicheskogo* pp. 5–15

⁸⁵ Ibrd p. 5

- Create and launch the Simplest Satellite into Earth orbit
- Launch a human on a "vertical" trajectory into space
- Recover a portion of the Simplest Satellite from Earth orbit

These three goals were to be carried out in parallel with each other and with the development of the R-7 ICBM, which would facilitate the implementation of the first objective.

Throughout the document, Tikhonravov goes into unusual detail for a report aimed at government bureaucrats, and one wonders, given the times, how much of it Ustinov or the others truly comprehended. The description of the Simplest Satellite included explanations of its launch trajectory, the characteristics of various potential orbits, its albedo in the night sky, three different orientation systems, power sources, and on-board instrumentation. Interestingly, he mentioned that a "special cassette" with scientific data would be recovered; this presumably would be exposed film of Earth's surface. Furthermore, a 300-kilogram television system would be installed on the satellite for transmitting images of Earth. Acknowledging that the creation of an oriented satellite would be a complex task, Tikhonravov wrote that:

in the event of the impossibility of a speedy solution [to installing an orientation system], it would be agreeable to have an unoriented [satellite], since aside from its scientific importance, the launch of the first satellite in our country would also have vast political significance.⁸⁶

The total mass of the vehicle was noted at 3,000 kilograms, composed of orientation systems, power sources, communications systems, a television unit, a recoverable cassette, film, scientific apparatus, and a container for an animal. The animal container would be installed on later Simplest Satellites.

The second section of the report addressed the launch of humans on vertical flights into space. Although particular rockets were not mentioned, it is likely that the reference was not to the R-7, but rather more modest missiles, such as the R-2 and R-5, in their scientific versions. Tikhonravov noted that these vertical launches would progress to true suborbital missions down range. Experience from the aviation industry would be used to design and construct appropriate cockpits for the single passenger.

In the third section, Tikhonravov addressed the methods of returning either the complete satellite or a portion of it to Earth. Both ballistic return and reentry with the aid of wings were detailed. The final section addressed future work:

- Creation of an "experimental satellite with humans"
- Creation of a "satellite-station"
- "[P]roblems of reaching the Moon"

It is clear throughout the entire document that Tikhonravov and Korolev's primary goal was to put one to two humans into Earth orbit aboard a satellite. In fact, at one point, the Simplest Satellite is described as "an apparatus without people." Orbital human spaceflight, according to the writing in the document, would be possible to accomplish in the nearest future based on the results of the three preliminary goals. The so-called "satellite-station" was merely an extension of piloted spaceflight: orbital assembly would be used as a means to create a large space station in Earth orbit crewed by specialists. The final long-term goal was the first-ever

86. *Ibid.*, p. 8.

87. *Ibid.*, pp. 13-14.

official mention in a Soviet document of plans to send spacecraft to the Moon. Although pilot-ed flight was not explicitly mentioned, Tikhonravov described a one-and-a-half-ton spacecraft capable of landing on the Moon and then returning to Earth by means of atmospheric braking. A three-stage "packet"-type rocket with a liftoff mass of 650 tons could be used for this purpose: he acknowledged that engine performance would have to be increased significantly for such a mission. There was even mention of interplanetary flight, which would be possible after accomplishment of the lunar expedition.

In the conclusion, Tikhonravov listed a number of goals of the complete program, focusing mostly on the scientific aspects, but noted that the creation of an artificial satellite would be of great importance to "defense." Korolev's attached letter was short and to the point:

At your request, I am enclosing the memorandum of Comrade M. K. Tikhonravov. "A Report on an Artificial Satellite of the Earth." and also forwarded materials from the U.S.A. on work being carried out in this field. The current development of [the R-7] makes it possible for us to speak of the possibility of developing in the near future an artificial satellite. By reducing the mass of the payload somewhat, we will be able to achieve the final velocity of 8,000 m/s necessary for a satellite. The product — the satellite — may be developed on the basis of the new [R-7] being developed now, referred to above, but with major modifications to the latter. It seems to me that in the present time there is the opportunity and expediency of organizing a scientific-research department [at NII-88] for carrying out the initial exploratory work on a satellite and more detailed work on complex problems involved with this goal. I await your decision⁸⁸

These two documents were the blueprints for the early days of the Soviet space program and stand testament to the vision of both Korolev and Tikhonravov. Most of the goals were eventually accomplished, although in 1954 none of the involved participants could foresee the eventual impact of the report.

If Korolev's goal was to elicit a formal decree for his proposal, his appeal was not very successful. However, his request seems to have been passed on through various levels of the government and reached the office of defense industry chief Malyshev, officially the Minister of Medium Machine Building. Prompted by Korolev's persuasive arguments, Malyshev, along with three other top defense industry officials, submitted a proposal to Soviet leader Malenkov asking permission to carry out "work on the scientific-theoretical questions associated with space flight." No doubt interested in the military applications of Tikhonravov's satellite, Malenkov approved the suggestion. Armed with a modicum of support, Korolev commenced a modest research project at his design bureau, coordinated with Tikhonravov's own work at NII-4. Incredibly, as this research was taking place, the satellite issue remained divorced from further governmental involvement as Korolev was diverted to more important matters relating to the operation of the nuclear-tipped R-5M missile and, of course, the work on the R-7 ICBM. It was, however, the very first intervention by the Soviet government on an issue related to space exploration.

⁸⁸ The text of this letter in a censored version has been published as S. P. Korolev "On the Possibility of Work on an Artificial Satellite of the Earth" (English title) in Keldysh ed. *Tvorcheskoye naslediyе Akademika Sergeya Pavlovicha Koroleva* p. 343. See also Raushenbakh ed. *Materialy po istorii kosmicheskogo* p. 209. Yaroslav Golovanov "The Beginning of the Space Era" (English title) *Pravda* October 4, 1987 p. 3. A. P. Romanov and V. S. Gubarev *Kosmicheskaya Korporatsiya* (Moscow: Politicheskoy literatury, 1989) p. 75.

⁸⁹ Semenov ed. *Raketno-Kosmicheskaya Korporatsiya* p. 86. The co-authors of the proposal were B. L. Vannikov (First Deputy Minister of Medium Machine Building), M. V. Khrunichev (First Deputy Minister of Medium Machine Building) and K. N. Rudnev (Deputy Minister of Defense Industries).

The International Geophysical Year and the Soviet Satellite

Korolev's satellite work may have continued at a leisurely pace through the mid-1950s with lukewarm governmental support were it not for some surprising and well-publicized events outside the Soviet Union. In the spring of 1950, a group of American scientists led by James A. Van Allen met in Silver Spring, Maryland, to discuss the possibility of an international scientific program to study the upper atmosphere and outer space via sounding rockets, balloons, and ground observations. Strong support from Western European scientists allowed the idea to expand into a worldwide program timed to coincide with a period of intense solar activity from July 1, 1957, to December 31, 1957. The participants named this period the international Geophysical Year (IGY) and created the *Comite speciale de l'année geophysique internationale* (the "Special Committee for the International Geophysical Year," or "CSACI") to establish an agenda for the program. Soviet representatives, including Academy of Sciences Vice-President Academician Ivan P. Bardin, served on CSAGI, but it does not seem that they had any significant contribution to its proceedings. In fact, the May 1954 deadline for submissions for participating in the IGY passed without any word from Soviet authorities. At a subsequent meeting in Rome on October 4, 1954, Soviet scientists silently witnessed the approval of a historic U.S.-sponsored plan to orbit artificial satellites during the IGY.⁹⁰ The satellite proposal clearly surprised the Soviet delegation, and perhaps it had repercussions within the USSR Academy of Sciences. In the fall of 1954, the academy established the Interdepartmental Commission for the Coordination and Control of Work in the Field of Organization and Accomplishment of Interplanetary Communications, a typically long-winded title that obscured its primary role—a forum for Soviet scientists to discuss space exploration in abstract terms, both in secret and in public."

The existence of the commission was announced on April 16, 1955, in an article in a Moscow evening newspaper. Academician Leonid I. Sedov, a relatively well-known gas dynamics expert, was listed as the chairman of the commission." Unlike the title of the body, the primary duty of the commission was stated with unusual explicitness: "One of the immediate tasks of the Commission is to organize work concerning building an automatic laboratory for scientific research in space."⁹¹ In hindsight, it is clear that the commission, a part of the Astronomy Council in the USSR Academy of Sciences, had very little input or influence over *de facto* decision-making in the Soviet space program. Although one of its functions was to collect proposals from various scientists on possible scientific experiments that could be mounted on future satellites, its more important role was to allow Soviet scientists, *but not designers*, to discuss general space issues in a public forum. Sedov played a major role in this respect by appearing at numerous international conferences talking in very general terms on the future of space exploration. None of the commission's members had any direct connection or contact

⁹⁰ Edward Clinton Ezell and Linda Neuman Ezell, *The Partnership: A History of the Apollo Soyuz Test Project* (Washington, DC: National Aeronautics and Space Administration (NASA) Special Publication (SP) 4209, 1978), p. 16; Nicholas Daniloff, *The Kremlin and the Cosmos* (New York: Alfred A. Knopf, 1972), p. 54.

⁹¹ Ishliinskiy, ed. Akademik S. P. Korolev, p. 453; U.S. Central Intelligence Agency (CIA), *National Intelligence Estimate 11558: Soviet Capabilities in Guided Missiles and Space Vehicles* (Washington, DC: CIA, August 19, 1958), as declassified February 15, 1995, by the CIA Historical Review Program, pp. 26–27; Boris Konovalov, 'The Genealogy of Sputnik' (English title) in V. Shcherbakov, ed. *Zagadki zvezdnykh ostrovov* (Moscow: Molodaya gvardiya, 1989), p. 115.

⁹² "Commission on Interplanetary Communications" (English title), *Vechernaya Moskva*, April 16, 1955, p. 1. An English translation of the article is included in F. J. Kruger, *Behind the Sputniks: A Survey of Soviet Space Science* (Washington, DC: Public Affairs Press, 1958), pp. 328–30. The names of only four other members were announced at the time: V. A. Ambartsumyan, P. L. Kapitsa, B. V. Kukarin, and P. P. Parenago. A larger twenty-seven member list was submitted to the International Astronautical Federation in October 1957.

⁹³ *Ibid.*

with the missile and space program, although they were clearly aware of the broad nature of Korolev's work. It seems that the latter had little to do with the formation or work of the commission. He evidently attended one meeting in 1954 to inquire about the group's work.⁹⁴

While this Commission had little real authority. Chairman Sedov may have played a crucial role in connecting Korolev's satellite efforts with the IGY. The chain of events was set off on July 29, 1955, by U.S. President Dwight D. Eisenhower's Press Secretary James C. Hagerty, who announced at the White House that the United States would launch "small Earth-circling satellites" as part of its participation in the IGY.⁹⁵ It was at this same time that the International Astronautical Federation was holding its Sixth International Astronautical Congress in Copenhagen, Denmark. Heading the Soviet delegation were Sedov and Kirill F. Ogorodnikov, the editor of a respected astronomy journal in the USSR. The two were called into action by an announcement on August 2 by Fred C. Durant III, the president of this congress, who reported the Eisenhower administration's intentions of launching a satellite during the IGY. Not to be outdone. Sedov convened a press conference the same day at the Soviet Embassy in Copenhagen for about fifty journalists during, at which he announced, "In my opinion, it will be possible to launch an artificial Earth satellite within the next two years." He added. "The realization of the Soviet project can be expected in the near future."⁹⁶

It is quite unlikely that Sedov was speaking on his own authority. and he possibly had taken cues from highly placed Communist Party officials who were aware of the government's approval in August 1954 of exploratory research on space issues. Perhaps a Party or Academy of Sciences official back in Moscow had decreed that Durant's statement warranted a response from Sedov. Certainly, there had been much discussion on the possibility of Soviet satellites by that time, although no single project had received approval. What is known is that the two pronouncements, the one by the Eisenhower administration and the one by Sedov, were the subject of relatively intense scrutiny by the press all over the world. This response seems to have been critical for Korolev.

The May 1954 satellite proposal from Korolev and Tikhonravov had not elicited the kind of response its authors had wanted. Despite the lukewarm reaction, both continued to appeal to various senior governmental officials. On January 18, 1955, Tikhonravov, with Korolev's agreement, sent a letter to Pashkov once again describing the possible uses of artificial satellites. By May, Tikhonravov, also with Korolev's supervision, prepared a series of documents on satellites, including a rough draft of a governmental decree, and he sent them to Pashkov, now a member of the new Special Committee, and Ustinov's Deputy Rudnev." There were also changes made to the original satellite document from 1954. On June 16, 1955, Tikhonravov and OKB-1 engineer Ilya V. Lavrov finished their latest study on artificial satellites. Based on Tikhonravov's earlier work, the two suggested a reduced mass of 1.000 to 1.400 kilograms for

94 Of the twenty seven commission members listed in 1957 only two individuals A A Blagonravov and D Ye Okhotsimskiy were directly involved in the ballistic missile and space programs The former headed the Commission for Upper Atmosphere Research of the Academy of Sciences which oversaw all scientific vertical launches The latter was one of the leading mathematicians at the Department of Applied Mathematics of the V A Steklov Mathematics Institute of the Academy of Sciences who was involved in the early design of the R 7 ICBM See Ishlinskiy ed *Akademi S P Korolev* p 453

95 'Statement by James C Hagerty The White House July 29 1955 ' reproduced as Document I 17 in John M Logsdon gen ed with Linda J Lear Jannelle Warren Findley Ray A Williamson and Dwayne A Day *Exploring the Unknown Selected Documents in the History of the US Civil Space Program Volume I Organizing for Exploration* (Washington DC NASA SP 4218) pp 200-01 Ezell and Ezell *The Partnership* p 18

96 Robert W Buchheim and the Staff of the Rand Corporation *Space Handbook Astronautics and its Applications* (New York Random House 1959) p 277 "Well Launch 1st Moon and Bigger Says Russ ' Los Angeles Examiner August 3 1955 John Hillary "Soviets Planning Early Satellite ' New York Times August 3 1955

97 Vetrov 'The First Satellite '

CHALLENGE TO APOLLO

the automated satellite. They also proposed the formation of a group of seventy to eighty people to carry out the task of designing and building the satellite and work on future piloted spacecraft (Korolev wrote in the margins: "Too many. 30-35 people."). Korolev, more attuned to the political reality of such a project, also added that "the creation of [a satellite] will have enormous political significance as evidence of the high development level of our country's technology."⁹⁸

The process seems to have gained extra urgency with the Eisenhower administration's announcement in late July. On August 8, Tikhonravov sent both Pashkov and Korolev a report titled "Basic Information on the Scientific Significance of the Simplest Satellite and Proposed Costs." Finally, on August 27, Tikhonravov sent another report to Pashkov, Chief Designer Glushko, and Chief Designer Ryazanskiy on the technical details of the satellite.⁹⁹ All this seemed to have had an effect. Pashkov asked his boss Ryabikov to hold a meeting of the powerful Special Committee to discuss the issue. Perhaps encouraged by the government's interest, Korolev decided to aim much higher than just a simple satellite. In a move that underscores Korolev's push for a space program, he had one of his sector chiefs at OKB-1, Yevgeniy F. Ryazanov, quickly prepare a technical report on the possibility of sending a probe to the Moon using modified versions of the R-7 ICBM. Ryazanov emerged with two different three-stage variants of the missile, one using the traditional liquid oxygen-kerosene combination and the other using fluorine monoxide and ethyl amine propellant. The former would launch a probe weighing 400 kilograms, and the latter would have a probe of 800 to 1,000 kilograms.

The meeting at the offices of the Special Committee was held on August 30, 1955. In attendance, besides Committee Chairman Ryabikov, Korolev, and Keldysh, was an engineer named Colonel Aleksandr G. Mrykin. Marshal Nedelin's chief means of contact with the missile design bureaus.¹⁰⁰ At the meeting, Korolev spoke of both his satellites and lunar probes but ran into resistance from Mrykin. Notorious for his legendary short temper and larger-than-life personality, Mrykin was not receptive to Korolev's old arguments of the possibly great political importance of a Soviet satellite. The artillery officer told Korolev that only when the R-7 had completed its flight testing would they consider a satellite. Fortunately for Korolev, he had Keldysh's support, and that may have tipped the scales. While details of the deliberations remain extremely sketchy, it seems that Ryabikov approved the use of an R-7 ICBM for a modest satellite program. Lunar probes were considered too outlandish. There were probably two factors working in Korolev's favor: the possible use of a satellite for military purposes and the Eisenhower administration's announcement of an IGY satellite program.

Armed with Ryabikov's approval, Korolev attended a second meeting the same day at the offices of the "chief scholarly secretary" of the Academy of Sciences, Gennadiy V. Topchiyev. Many other scientists and designers, including Keldysh, Tikhonravov, and Glushko, were present. Korolev reported to the distinguished assemblage that the Council of Chief Designers at a recent meeting had conducted a detailed examination of modifying the original R-7 into a vehicle capable of launching a satellite into orbit. No doubt, he also spoke of the government's interest on the matter. At the end of his speech, he made a formal call to build and launch a

98. *Ibid.*; Semenov, ed., *Raketno-Kosmicheskaya Korporatsiya*, pp. 86-87; Golovanov, "The Beginning of the Space Era." There is some confusion as to who authored this report and when it was issued. The above sources suggest that it was Lavrov alone who authored the report and that it was dated June 16, 1955. On the other hand, in his own memoirs, Tikhonravov writes that the memorandum was co-authored by both and that it was dated July 16, 1955. See Ishlinskiy, ed., *Akademik S. P. Korolev*, p. 445.

99. Vetrov, "The First Satellite."

100. Semenov, ed., *Raketno-Kosmicheskaya Korporatsiya*, p. 87. Mrykin's official post was First Deputy Commander of the Directorate of the Chief of Reactive Armaments (UNRV). UNRV was part of the Chief Artillery Directorate (CAU) of the Ministry of Defense.

series of satellites, including one with animals, into space, and he asked that the Academy of Sciences establish a formal commission to carry out this goal. Korolev had a specific timetable in mind. He told his assemblage, "As for the booster rocket, we hope to begin the first launches in April-July 1957 . . . before the start of the International Geophysical Year."¹⁰¹ If Korolev's earlier Simplest Satellite plans had been timed for the indefinite future, the Eisenhower administration's announcement in July 1955 completely changed the direction of Korolev's attack. Not only did it imbue Korolev's satellite proposal with a new sense of urgency, but it also gave him a specific timetable for which to aim. If the United States was planning to launch during the IGY, then the Soviets would launch one a few months before the beginning of the IGY. The attending scientists at the meeting accepted the new satellite proposal. At Korolev's recommendation, Keldysh was designated the chairman of the commission; Korolev and Tikhonravov were to serve as his deputies.

The following day, on August 31, a smaller group, including Korolev, Tikhonravov, and Keldysh, met to discuss some of the proposals for satellite instruments that many scientists had submitted to Sedov's commission during the past year. A few days later, Tikhonravov and Keldysh convened with some prominent Soviet scientific scholars to explain details of the satellite design and how their instruments were being considered. Korolev himself approved a preliminary scientific program in September 1955, which included the study of the ionosphere, cosmic rays, Earth's magnetic fields, luminescence in the upper atmosphere, the Sun and its influence on Earth, and other natural phenomena. The detailed development of a scientific program was left in the hands of the two existing commissions of the Academy of Sciences headed by Blagonravov and Sedov.¹⁰²

The approval by the Academy of Sciences to conduct a purely scientific research program accelerated matters considerably. In the ensuing months, several important meetings were held, both by Keldysh's commission and by the Council of Chief Designers, which elaborated on the details of the project. Between December 1955 and March 1956, Keldysh consulted a huge number of distinguished scholars to refine the scientific experiments package. They included numerous famous Soviet scientists, many of whose names were public knowledge, unlike those who were actually developing the spacecraft.¹⁰³ It was a large-scale operation with a single coordinating mechanism, which, because of its "civilian" nature, had no precedent. Korolev himself was very conscious of the fact that official governmental approval had yet to be granted, which meant that a rocket for the project was still not available, but the magnitude of the immediate tasks obscured that important issue for the time being. There were continuous problems with the program because many of those who were cooperating did not share Korolev's enthusiasm for the project. For a purely civilian endeavor, the wealth of institutes and design bureaus with which he had to deal was also unprecedented.

It took about four months for Ryabikov's spoken approval in August 1955 to translate into a formal decree of the Soviet government. As a purely scientific project managed by the

¹⁰¹ Ishlinskiy ed *Akademik S P Korolev* p 455 Colovanov *Korolev* pp 523-24 Colovanov "The Beginning of the Space Era" Others present at this meeting were M A Lavrentiyev and C A Skuridin

¹⁰² Ishlinskiy ed *Akademik S P Korolev* pp 455-56 Lardier *L'Astronautique Soviétique* p 107 Colovanov "The Beginning of the Space Era" Blagonravov's commission was at the time directing the scientific investigations aboard suborbital rockets while Sedov's commission had recently been established as a public forum for Soviet scientists to discuss space exploration

¹⁰³ These included atmospheric specialists V I Krasovskiy, L V Kurnosovaya, and S N Vernov the young mathematicians from the Department of Applied Mathematics T M Eneyev, M L Lidov, D Ye Okhotsimskiy, and V A Yegorov solar battery expert N S Lidorenko and the more famous Academicians L A Artsimovich, V L Ginsburg, A F Ioffe, P L Kapitsa, B P Konstantinov, and V A Kotelnikov See Ishlinskiy ed *Akademik S P Korolev* pp 446-456 Colovanov "The Beginning of the Space Era"

Academy of Sciences, it was not considered a top priority. In fact, Soviet government officials probably viewed the satellite project in much the same manner as they viewed the continuing series of scientific rocket flights into the upper atmosphere—an effort that also used military missiles for civilian purposes. Such flights were relatively inexpensive, unobtrusive, and ignored by the political leadership. Consequently, the USSR Council of Ministers issued a decree (no. 149-88ss) on January 30, 1956, calling for the creation of an unoriented artificial satellite. The document approved the launch of a satellite, designated "Object D," in 1957 in time for the ICY. As per Tikhonravov's previous computations, the mass of the satellite was limited to 1,000 to 1,400 kilograms, of which 200 to 300 kilograms would be scientific instruments. Apart from the Academy of Sciences, five industrial ministries would be involved in the project. The responsibility for preparing a draft plan for Object D fell on the shoulders of Sergey S. Kryukov, at the time a department chief at OKB-1. Tikhonravov served as the "chief scientific consultant."¹⁰⁴ At least two main points of the original report from 1954 were ignored: the Party squelched any hope that the satellite would have an orientation system or that it would carry a human. Although the text of the decree remains classified, other evidence hints that one of the stipulations of the document was to approve exploratory work on a military photo-reconnaissance satellite at NII-4 based on the design of Object D."

At the time that the resolution was adopted, Korolev was at Kapustin Yar in preparation for the nuclear R-5M test, an experiment that was certainly far more important to the fortunes of OKB-1 than the satellite project. It is apparent, however, that Korolev did not want to consign his dreams of space exploration to a single decree, one among as many as 250 discussed per month by the Presidium (later the Politburo). He wanted a direct verbal promise from the Soviet leadership on the satellite project, in particular from Khrushchev himself. His chance came in February 1956 during a high-level state visit to OKB-1. Khrushchev, escorted by the top Presidium members Bulganin, Molotov, and Pervukhin, as well as Minister Ustinov, were on hand to congratulate OKB-1 on its recent success with the R-5M and also to review the progress on the R-7 ICBM project.¹⁰⁶

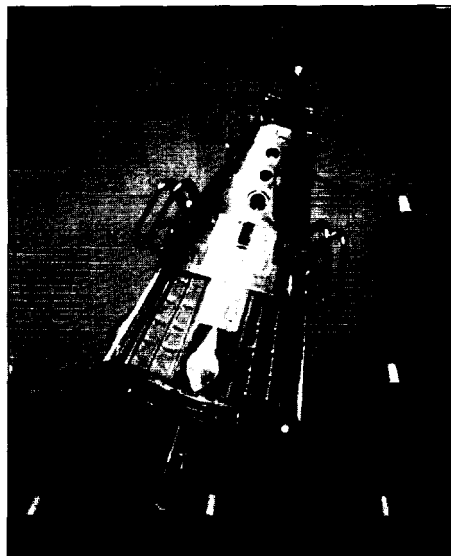

A model of the Object D satellite shown suspended in a museum. The 1.3 ton observatory carried instruments for the study of Earth's ionosphere, magnetic fields, radiation belts, cosmic rays, meteoroids, and so forth. (copyright Quest)

¹⁰⁴ Keldysh, ed., *Tuorcheskoye naslediyе Akademika Sergeya Pavlovicha Koroleva*, p. 362. Ishlinskiy, ed., *Akademik S. P. Korolev*, p. 445; Kononov, "The Genealogy of Sputnik," pp. 116–17; Colovanov, Korolev, p. 529; Semenov, ed., *Raketno-Kosmicheskaya Korporatsiya*, p. 87; B. Kononov, "Dash to the Stars" (English title), *Izvestiya*, October 1, 1987, p. 3. The five industrial ministries were the Ministry of Defense Industries, the Ministry of Radiotechnical Industry, the Ministry of Ship Building Industry, the Ministry of Machine Building, and the Ministry of Defense.

¹⁰⁵ See, for example, Valery Menshikov, "Theory and Practice Go Together," *Aerospace Journal* no. 2 (March–April 1997): 28–29. Referring specifically to the January 1956 decree, the author states, "The task of researching possible applications of defense satellites . . . was entrusted to the country's Defense Ministry."

¹⁰⁶ Sergey Khrushchev, *Nikita Khrushchev: krizisy i rakety: uzglyad iznutri: tom 1* (Moscow: Novosti, 1994), p. 97.

The visit, on the morning of February 27, was important for Khrushchev because it was his first direct exposure to the top-secret ballistic missile program—an effort that had essentially been run by a number of industrial bureaucrats since Stalin's death, out of view from Party leaders such as Khrushchev." During the visit, the delegation was escorted by Korolev and NII-88 Director Aleksey S. Spiridinov on a tour that culminated with a presentation of a full-scale model of the R-7 ICBM. The guests were apparently stunned into silence by the size of the vehicle. Like a good performer, Korolev waited a few seconds for the sight to sink in before giving a brief presentation on the vehicle. Khrushchev simply beamed after the report, visibly impressed with the capabilities of the missile.

Clushko then began an elaborate presentation, much different from Korolev's, filled with extraneous technical details "like he was talking to first course students at the neighboring forestry institute . . . rather than the higher leadership."¹⁰⁸ Recognizing the pointlessness of a technical treatise, Korolev cut Clushko short, before summarizing with a succinct conclusion. After a short discussion on the R-7's capabilities, Korolev innocuously added. "Nikita Sergeevich [Khrushchev], we want to introduce you to an application of our rockets for research into the upper layers of the atmosphere, and for experiments outside the atmosphere." The Soviet leader expressed polite interest, although it was clear by this time that most of the guests were becoming tired and bored with the proceedings. Undeterred, Korolev first showed them huge photographs of suborbital missiles that were used for biological and geophysical investigations. Detecting that his guests were in a hurry to leave, he quickly moved ahead and pointed everyone's attention to a display in a corner of the room of a model of an artificial satellite that had been created as part of the satellite program of the Academy of Sciences. Invoking the name of a legendary Soviet scientist, Korolev hurriedly explained that it was possible to realize the dreams of Tsiolkovskiy with the use of the R-7 missile. Korolev pointed out that the United States had stepped up its satellite program, but that compared to the "skinny" U.S. launch vehicle, the Soviet R-7 could significantly outdo that project in terms of the mass of the satellite. In closing, he added that the costs for such a project would be meager, because the basic expense for the launcher was already allocated in the R-7 booster.

Khrushchev began to exhibit some interest, and he asked Korolev if such a plan might not harm the R-7 weapons research program, given that was the primary focus of work at Korolev's design bureau. Clearly oversimplifying the difficulties involved, Korolev shot back that unlike the United States, which was spending millions of dollars to develop a special rocket to launch a satellite, all the Soviets would have to do was replace the warhead with a satellite on the R-7. Khrushchev hesitated for a second, perhaps suspicious of Korolev's intentions, but answered back. "If the main task doesn't suffer, do it."¹⁰⁹

After more than two years of explicit lobbying, the artificial satellite project was a reality. And it owed its approval to Korolev more than anyone. Tikhonravov had provided the technical expertise, and Keldysh had helped with his political clout, but it was finally Korolev's repeated requests, letters, meetings, reports, and entreaties that finally forced the decision. Korolev also had a climate conducive to his needs. His standing among the military and industrial community had evolved over the years from maverick engineer to genius manager. His successes with the series of ballistic missiles pleased both the military and industry. Also, it did not hurt that both of these sectors, by 1956, were populated by individuals who were sympathetic to the Korolev's unquenchable thirst for space exploration. Clearly, Korolev alone could not have

107. Barry. "The Missile Design Bureaux."

108. Khrushchev, *Nikita Khrushchev: tom I*, p. 106.

109. *Ibid.*, p. 109.

110. *Ibid.*, pp. 110–11. For other brief descriptions of the February 1956 visit, see Ishlinskiy, ed., *Akademiya S. P. Korolev*, pp. 319–20, 337–38.

done it. Events outside his control—such as the Eisenhower administration's announcement, Sedov's press conference, the fall of the Beriya group in the nuclear weapons industry, and Khrushchev's rise to power—were pivotal events on the road to approval. But hindsight suggests that the Soviet space program was born on January 30, 1956, and without Korolev, it would have never been conceived.

From Object D to the Simple Satellite

Object D (or D-1) was so named because it would be the fifth type of payload to be carried on an R-7. Objects A, B, V, and G were designations for different nuclear warhead containers.¹¹¹ The satellite was a complex scientific laboratory, far more sophisticated than anything planned for launch in the world in 1956. While Kryukov's engineers depended greatly on Tikhonravov's early work on satellites, much of the actual design was a journey into uncharted territory for OKB-1. There was little precedent for creating pressurized containers and instrumentation for work in Earth orbit, while long-range communications systems had to be designed without the benefit of prior experience. The engineers were aware of the trajectory tracking and support capabilities for the R-7 missile, and this provided a context for determining the levels of contact with the vehicle. The fact that the object would be out of contact with the ground for long periods of time (unlike sounding rockets) meant that new self-switching automated systems would have to be used. The selection of metals to construct the satellite also presented problems to the engineers because the effects of continuous exposure to the space environment were still in the realm of conjecture. The experiments and experience from sounding rocket tests provided a database for the final selection.

On February 25, 1956, the Keldysh commission issued the technical requirements for building the satellite: detailed design work began on March 5. Tikhonravov's group at NII-4 and Korolev's OKB-1 at NII-88 were the two most active participants in this process, but numerous other organizations contributed to various elements of the complete satellite. By June 14, Korolev had finalized the necessary changes to the basic 8K71 version of the R-7 ICBM to use it for a satellite launch. The new booster, designated "product 8A92," would incorporate a number of major changes, including the use of uprated main engines, the deletion of the central radio package on the booster, and a new payload fairing replacing the one used for a nuclear warhead. A month later, at a meeting of chief designers on July 24, 1956, Korolev formally signed the initial draft plan for Object D. The document was co-signed by his senior associates Tikhonravov, Bushuyev, Okhapkin, and Voskresenskiy.¹¹²

The intensive work on Object D was obviously not only project at OKB-1. In fact, officially at least, it was an effort with very low priority, far behind the plethora of military work that Korolev oversaw during this period. These included the dozens of test launches of the strategic R-5M, the experimental M-5RD and R-5R missiles, and the world's first submarine-launched ballistic missile, the R-11FM. He also directed draft plan work on an improved version of the nuclear R-5M, the experimental R-5R, the basic R-11FM, and an underwater version of the same missile. He was the scientific leader for the enormous R-7 ICBM effort and the work on the short-range R-11M, both yet to fly. This was in addition to work on scientific missiles such as the R-1Ye, the R-5A, and of course Object D. There were also various conferences, meetings, and functions to attend. Given the magnitude of work at OKB-1, it was becoming cumbersome

¹¹¹ Raushenbakh, ed., *Materyaly po istorii kosmicheskogo*, p. 209. A, B, V, G, and D are the first five letters of the Russian Cyrillic alphabet.

¹¹² Goiovanov, *Korolev*, p. 530; Ishlinskiy, ed., *Akademitk S. P. Korolev*, p. 446; Varfoimneyev, "Soviet Rocketry that Conquered Space. Part I." Tikhonravov was officially an employee of NII-4, but he was temporarily working as the chief consultant to NII-88's OKB-1.

to deal with OKB-I as a functional unit of NII-88. Thus, by an order (no. 310) of the Ministry of Defense Industries, dated August 14, 1956. OKB-I became a separate and independent organization within the ministry, with its own production plant and scientific research departments." It took ten years for Korolev's small department at a research institute to evolve into an independent organization with thousands of employees—one that was the leading developer of long-range ballistic missiles in the Soviet Union, and the only one working on a space program.

It was at the same time that four of Korolev's deputies were officially named deputy chief designers of the independent entity: Vasilii P. Mishin (first deputy for planning-design work), Konstantin D. Bushuyev (deputy for planning), Sergey O. Okhapkin (deputy for design and documentation), and Leonid A. Voskresenskiy (deputy for ground and flight-testing). With the exception of Korolev and Mishin, Bushuyev was the most powerful person at OKB-I. An exceptionally intelligent and learned individual, he had played a leading role in the development of every single ballistic missile at NII-88, beginning with the R-2 rocket in the late 1950s. The forty-two-year-old engineer was OKB-I's expert in the areas of project planning, project parameter selection, and computation and research work on aerodynamics, ballistics, stability, surface tension, and missile mass balance. Upon Bushuyev's new appointment as deputy at OKB-I, he inherited all the work on space themes at the design bureau. By 1961, his sole responsibility was all of the space vehicle development, thus overseeing every single piloted space project through the 1960s and 1970s.¹¹³ Bushuyev's new appointment had a second dimension. For almost two years, Korolev had been lobbying for a transfer of Tikhonravov's productive group at NII-4 to OKB-I. With the acceleration of work on Object D, the government finally agreed to the request, and on November 1, 1956. Tikhonravov and most of his group of assistants were institutionally transferred to OKB-I, under Bushuyev's command, to comprise the new Department No. 9 dedicated to space themes.¹¹⁴ Yevgeniy F. Ryazanov was named Tikhonravov's deputy, while another assistant, Ilya V. Lavrov, was appointed to oversee the technical aspects of the Object D effort.

By mid-1956, the Object D project was beginning to fall significantly behind schedule. Some subcontractors were particularly lackadaisical in their assignments, and parts were often delivered that did not fit the original specifications. On September 14, Keldysh made a personal plea at a meeting of the Academy of Sciences Presidium for speeding up work, invoking a threat all would understand: "we all want our satellite to fly earlier than the Americans."¹¹⁵ To com-

113 Chertok *Rakety i lyudi* p 356 Colovanov Korolev p 464 'TsNIIMash—One of the Leading Space Branches' Ishlinskiy ed *Akademik 5 P Korolev* p 446 Although the order was signed in August 1956 it seems that the separation was not enacted until September–October 1956 See Yu A Mozzhorin 'The Central Scientific Research Institute of Machine Building—The Chief Center in the Soviet Rocket Space Industry' (English title) *Iz istorii aviatsii i kosmonautiki* 60 (1990) 20–40

114 Chertok *Rakety i lyudi* p 356 All had already been officially appointed deputy chief designers but they had been serving in that capacity in NII 88s OKB I not the independent OKB I Mishin had been appointed in April 1950 Okhapkin in December 1952 Voskresenskiy in October 1953 and Bushuyev in 1954 Chertok also suggests that A P Abramov was one of those appointed as chief designers in August 1956 but by Abramov's own account he was not promoted to such a post until 1966 By 1961 at least nine other engineers had been appointed deputy chief designers B Ye Chertok D I Kozlov S S Kryukov P I Meleshin M V Melnikov M F Reshetnev Ye V Shabarov M K Tikhonravov and P V Tsybin

115 S S Kryukov 'K D Bushuyev—Scholar Planner Technical Director of the Soyuz Apollo Program' (English title) in B V Raushenbakh ed *Issledovaniye tvorchestva osnoupopolozhntkovkosmonautkr i ee sovremennyye problemy* (Moscow Nauka 1989) p 41 M V Keldysh A A Dorodnitsyn and S P Korolev 'On the Scientific Activities of K D Bushuyev' (English title) in Avduyevskiy and Eneyev eds M V Keldysh pp 197–98

116 Ishlinskiy ed *Akademik 5 P Korolev* p 447 Korolev's first request for transferring Tikhonravov's department was during a meeting with Ustinov on December 22, 1954. He repeated the request to Nedelin on December 27, 1955.

117 An edited version of Keldysh's speech has been published as M V Keldysh 'On Artificial Satellites of the Earth' (English title) in Avduyevskiy and Eneyev eds M V Keldysh pp 235–40 See also Golovanov Korolev p 530

pensate for the volume of work. Korolev finalized a plan ten days later to divide the work into three variants of the basic Object D, each distinguished by the nature of its scientific apparatus. He then signed an amended draft plan for the satellite on September 25. Its eight scientific goals were listed as:

- Measurement of atmospheric density, pressure, and ion composition at altitudes between 200 and 500 kilometers
- Research into solar corpuscular radiation
- Measurement of ion concentrations in the chosen orbit
- Measurement of inherent electrical charges
- Measurement of Earth's magnetic fields at altitudes of 200 to 500 kilometers
- Studies of cosmic rays
- Research into ultraviolet and x-ray portions of the solar spectrum
- Research into the possibility of ensuring the survival of an animal in orbit"

Although many of the specifics had changed, much of the basis for Object D was taken from the historic proposal for the Simplest Satellite, which was submitted to the government in 1954. At a special meeting on September 28, 1956, the Keldysh commission fully approved the draft plan, thus freezing the final design of the spacecraft.¹¹⁸

Tikhonravov's department had by this time emerged with three airtight designs of Object D, each with a roughly conical shape and a mass between 1,000 and 1,400 kilograms. The most favored version included a power supply system with solar and chemical batteries and used a special system of louvers on the exterior and fans on the interior for thermal regulation. There were also radio communications devices with multichannel capability for transmitting telemetric data and receiving ground commands. Three quarters of the mass of the object consisted of scientific instruments. In one of the three versions of Object D, engineers ensured the possibility of installing a small cockpit to carry a dog into orbit.¹²⁰ This cabin was a direct modification of capsules launched aboard the upper atmosphere sounding rockets throughout the 1950s. Few details have been released on the biological version of Object D, although presumably the animal capsule inside the conical spacecraft was not recoverable, as specified in the original 1954 document.

Events in the satellite program took an abrupt turn in the waning months of 1956. Actual test models of Object D, expected to be ready by October, remained unfinished. By early November, Korolev was suffering from great anxiety, no doubt compounded by his extraordinarily busy plans, as he traveled from Kaliningrad to Kapustin Yar to Tyura-Tam to Molotovsk and back several times to oversee various projects." Part of this anxiety was from serious concerns that his project would be suddenly preempted with a satellite launch from the United States. In September 1956, the U.S. Army had launched a Jupiter C missile from Patrick Air Force Base at Cape Canaveral, Florida, that could have launched a satellite into orbit if it had included a live third stage. Korolev mistakenly believed that it had been a secret attempt to launch a

¹¹⁸ The complete text of the draft plan has been published as S. P. Korolev, *et al.*, "Thesis Report on the Development of a Draft Plan for an Artificial Satellite of the Earth" (English title), in Keldysh, ed., *Tuorcheskoye naslediyе Akademika Sergeya Pavlovicha Koroleva*, pp. 362–68.

¹¹⁹ Ishlinskiy, ed., *Akademiк S. P. Korolev*, p. 447. The draft plan was approved by the Special Committee on September 30, 1956.

¹²⁰ Yu. Biryukov, "From the History of Space Science: The Price of Decision—First Place (The First Satellites)" (English title), *Aviatsiya i kosmonavtika* no. 10 (October 1991): 37–39.

¹²¹ Kaliningrad was the location of OKBI, while sea trials of the R-11FM were carried out near Molotovsk

satellite.¹²² A second concern were the results of static testing of the R-7 engines on the ground. Instead of the projected specific impulse of 309 to 310 seconds, the R-7 engines could not produce more than 304 seconds—too low for the heavy Object D satellite. He realized that perhaps he was making this effort too complicated. Why not attempt to launch something simpler on the first orbital attempt instead of a sophisticated one-and-a-half-ton scientific observatory?

At the end of November, Tikhonravov was perceptive enough to detect Korolev's anxiety and verbalized it: "What if we make the satellite a little lighter? Thirty kilograms or so, or even lighter?"¹²³ Not one to sit still, Korolev immediately took action on the matter. On November 25, he ordered a young engineer at OKB-1, Nikolay A. Kutyркиn, to begin designing this new smaller satellite. Another young man, Georgiy M. Grechko, set about calculating preliminary ballistics on the launch. Politically, it was not all that easy. Keldysh was dead set against the idea, which was not surprising because he had invested so much time and energy into Object D. There were other engineers within OKB-1 who were also not too enthused by the new plan. All eventually ceded to the strong-willed Korolev. As insurance, Korolev decided not to depend on dozens of other subcontractors. He made sure that the satellite would be designed and manufactured completely within his own design bureau with the help of only two outside organizations: the Scientific-Research Institute of Current Sources under Nikolay S. Lidorenko for the design of the on-board batteries and NII-885 under Chief Designer Ryazanskiy for the radio transmitters.

On January 5, 1957, Korolev sent a letter describing his revised plan to the Special Committee. He asked for permission to launch two small satellites, each with a mass of forty to fifty kilograms, during the period of April–June 1957 immediately prior to the beginning of the IGY. Once again, his thinking was simple: because the United States had plans for launching satellites during the IGY, he could ensure Soviet preeminence by launching one before the start of the IGY. This plan would be contingent on the timetable for the R-7 program, which Korolev admitted was behind schedule; the first launch of the missile was set for March 1957, at the earliest. Each satellite would orbit Earth at altitudes of 225 to 500 kilometers and contain a simple shortwave transmitter with a power source sufficient for ten days' operation. Korolev did not obscure the reasons for the abrupt change in plans:

... the United States is conducting very intensive plans for launching an artificial Earth satellite. The most well-known project under the name "Vanguard" uses a three-stage missile ... the satellite proposed is a spherical container of 50 centimeters diameter and a mass of approximately 10 kilograms. In September 1956, the U.S.A. attempted to launch a three-stage missile with a satellite from Patrick Base in the state of Florida which was kept secret. The Americans failed to launch the satellite ... and the payload flew about 3,000 miles or approximately 4,800 kilometers. This flight was then publicized in the press as a national record. They emphasized that U.S. rockets can fly higher and farther than all the rockets in the world, including Soviet rockets. From separate printed reports, it is known that the U.S.A. is preparing in the nearest months a new attempt to launch an artificial Earth satellite and is willing to pay any price to achieve this priority.¹²⁴

122. The launch about which Korolev was informed was a Jupiter C missile (no. RTV-1), which flew a distance of 5,300 kilometers on September 20, 1956, during a reentry test. A live third stage could have put a small payload into orbit.

123. Golovanov, "The Beginning of the Space Era"; Golovanov, *Korolev*, p. 532.

124. The complete text of Korolev's letter is reproduced as S. P. Korolev, "Proposal on the First Launch of an Artificial Satellite of the Earth Before the Start of the International Geophysical Year" (English title), in Keldysh, ed., *Tvorcheskoye naslediyе Akademika Sergeya Paulovichа Koroleva*, pp. 369–70.

While Korolev's information on U.S. plans may have been in error, his instincts were not that far off. The United States could have launched a satellite by early 1957, but various institutional and political obstacles precluded such an attempt.

By January 25, 1957, Korolev had approved the initial design details of the satellite officially designated the Simple Satellite No. 1 (PS-1). It seems that his letter had adequately invoked the specter of U.S. eminence in the field of military technology: Special Committee Chairman Ryabikov was evidently strongly in favor of the new plan. His support proved to be crucial. On February 15, the USSR Council of Ministers formally signed a decree (no. 171-83ss) titled "On Measures to Carry out in the International Geophysical Year," agreeing to the new proposal.¹²⁵ The two new satellites, PS-1 and PS-2, would weigh approximately 100 kilograms and be launched in April–May 1957, after one or two fully successful R-7 ICBM launches. Meanwhile, the Object D launch was pushed back to April 1958. Focused on a more modest objective, Korolev wasted little time. He quickly sent out technical specifications for the initial satellite PS-1 to the two subcontractors. In addition, the Experimental Design Bureau of the Moscow Power Institute under Chief Designer Aleksey F. Bogomolov modified its Tral telemetry system on the R-7 for use on the satellite launch.¹²⁶ By this time, there was an impressive sight at the Tyura-Tam launch base: the first flight article of the magnificent R-7 was on the launch pad.

The R-7 in Flight

The R-7 launch program, as with any other important weapons project, was overseen through its test program under the guidance of a special State Commission, a temporary ad hoc body comprised of various representatives of the military, industry, and the design bureaus.



The State Commission for the Sputnik satellite shown in 1957. Seated left to right are Ivan Bulychev, Grigoriy Udarov, Aleksandr Mrykin, Nikolay Pilyugin, Mstislav Keldysh, Vasily Mishin, Leonid Voskresenskiy, Vasily Ryabikov, Mitrofan Nedelin, Sergey Korolev, Konstantin Rudnev, Valentin Glushko, and Vladimir Barmin. Standing left to right are Aleksey Bogomolov, Pavel Trubachev, Viktor Kuznetsov, Anatoliy Vasilyev, Konstantin Bushuyev, Aleksandr Nosov, Ivan Borisenko, Aleksey Nesterenko, Georgiy Pashkov, Mikhail Ryazanskiy, and Viktor Kurbatov. (files of Asif Siddiqi)

125. Semenov, ed., *Raketno-Kosmicheskaya Korporatsiya*, pp. 88, 632. Ishlinskiy, ed., *Akademiya S. P. Korolev*, p. 447. Other sources say that the decree was issued on February 7, 1957. See Vetrov, "The First Satellite."

126. Lardier, *L'Astronautique Soviétique*, p. 108; Ishlinskiy, ed., *Akademiya S. P. Korolev*, p. 447. Actual tests of the Instrument were conducted beginning May 5, 1957, in which a helicopter was used to track the satellite using a 200-meter cable. The technical specifications for the PS-1's radio transmitter were approved on February 15, 1957, the same day that the project was approved by the Soviet government.

Unlike formal and permanent institutions such as the Special Committee or the Military-Industrial Commission, the State Commission would remain in existence only during the testing phase, and it would serve as the primary conduit for communication with Party leaders, such as Khrushchev, on the state of the program. The USSR Council of Ministers—that is, Khrushchev and Bulganin—established a fourteen-member State Commission for the R-7 test series on August 31, 1956. Vasiliy M. Ryabikov, the powerful industrial bureaucrat who oversaw the entire missile industry as chairman of the Special Committee for Armaments of the Army and Navy, was appointed to lead the body. Korolev was a deputy chairman and "technical leader." The remainder consisted of three military representatives (Mrykin, Nedelin, and Nesterenko), five chief designers (Barmin, Glushko, Kuznetsov, Pilyugin, and Ryazanskiy), and four men from the defense industry (Pashkov, Peresyarkin, Udarov, and Vladimirskiy). Although they were not official members of the commission, two scientists, Mstislav V. Keldysh and Aleksandr Yu. Ishlinskiy, participated in its proceedings."

The R-7 had run into some major delays in late 1956, primarily related to the work on the main engines. Although the first launch was originally planned for early 1957, it had been progressively shifted to March of that year. Typical of large-scale endeavors, there were numerous subcontractor and management problems, all of which were addressed by the State Commission in late 1956. As Korolev reported in a letter to the government, "The preparatory operations for the first launch of the rocket are proceeding with significant difficulties and behind schedule. . . ." ¹²⁸ The static tests of complete first and second stages at Zagorsk finally cleared the way for launch planning, and the first experimental model of the R-7, the 8K71SN, was transported from Leningrad and assembled at Tyura-Tam in December 1956 for placement on the launch pad and subsequent captive tests. The operation of the ground segment of the telemetry network was also given a thorough checkout at the time, with the first telemetric contact between Tyura-Tam and Moscow established on December 27. The tracking, telemetry, and command network, officially called the Range Measurement Complex, comprised nine Tayga stations located at various points between one and a half and 800 kilometers from the launch pad at site I, as well as six Kama stations placed between thirty-two and 120 kilometers from

127 Semenov ed. *Raketno-Kosmicheskaya Korporatsiya* p. 79. The official positions of the members of the state commission for the R-7 were: V. M. Ryabikov (Chairman of the Special Committee); S. P. Korolev (Chief Designer of OKB-1); A. G. Mrykin (First Deputy Chief of the Directorate of the Chief of Reactive Armaments); M. I. Nedelin (Deputy Minister of Defense for Reactive Armaments); A. I. Nesterenko (Commander of NIIP-5); V. P. Barmin (Chief Designer of GKSB SpetsMash); V. P. Glushko (Chief Designer of OKB-456); V. I. Kuznetsov (Chief Designer of NII-10); N. A. Pilyugin (Chief Designer of NII-885); M. S. Ryazanskiy (Chief Designer and Director of NII-885); C. N. Pashkov (Deputy Chairman of the Special Committee); I. T. Peresyarkin (Minister of Communications); G. R. Udarov (Deputy Minister of Machine Building); and S. M. Vladimirskiy (Deputy Minister of Radio Technical Industry). M. V. Keldysh was the Chief of the Department of Applied Mathematics of the V. A. Steklov Mathematics Institute of the Academy of Sciences and Director of NII-1 while A. Yu. Ishlinskiy was the Director of the Moscow Institute for Problems of Mechanics and 'Scientific Consultant' to NII-10. By the time that launches of the R-7 began in May 1957, several other men were involved with the work of the State Commission, including I. T. Bulychev (Chief of the Communications Directorate of the Ministry of Defense); I. S. Konev (First Deputy Minister of Defense); A. A. Maksimov (from the Directorate of the Chief of Reactive Armaments); N. D. Psurtsev (Minister of Communications); K. N. Rudnev (Deputy Minister of Defense Industries); and S. P. Shishkin (Chief Designer of KB-11). See Council of Veterans of the Baykonur Cosmodrome, *Proryv kosmos*, pp. 10-11; A. A. Maksimov, "Heat, Water, and Red Buttons—or Rehearsal of the Historic Launch" (English title) *Zemlya i uselennaya* no. 5 (September-October 1990): 60-65; A. A. Maksimov, "The First Launch From Baykonur" (English title) *Zemlya i uselennaya* no. 1 (January-February 1991): 89-93.

128 Golovanov, "The Beginning of the Space Era."

the target area in the Kamchatka peninsula in the eastern Soviet Union, about 6.500 kilometers from Tyura-Tam.¹²⁹

On March 4, 1957, Korolev signed the Technical Assignment No. 1 document, formally approving preparations for the launch. Through the remaining days of March and April, various members of the State Commission flew into Tyura-Tam. Korolev, in the company of Chief Designer Pilyugin, arrived on April 10, followed by Chairman Ryabikov six days later. On the way to the launch range, Korolev had told Pilyugin that he would not return until the missile had flown. The presence of high-ranking military officers Nedelin and Mrykin markedly increased the tension at the launch site, partly because of Mrykin's reputation for terrifying reprimands for those that were not doing their job well. Others remember the atmosphere as being festive as a result of local troops being relocated to new barracks from their previous homes in railway cars. On Korolev's suggestion, officials carried out a complete dress rehearsal of the transportation from the Assembly-Testing Building at site 2 to the launch pad at site 1 on May 4.¹³⁰ At the pad itself, the missile was uprighted over the launch structure and held down by the pad's four "petals." After installation, engineers established electrical and pneumatic connections with ground equipment. The entire rehearsal was uneventful, save for a humorous incident involving Marshal Nedelin, who had decided to check whether the emergency alarm system for the launch site was in working order. When the appropriate alarm button was pressed, nothing happened. Fuming at the failure, Nedelin vented with full force at engineer Lt. Colonel Aleksandr I. Nosov, the Deputy Commander of NIIP-5 for Experimental-Test Work. Several members of the State Commission entered the command bunker, where they discovered that a young army sergeant on a cigarette break had left a particularly important switch in the wrong position. Suddenly, the emergency alarm went off, and the fire squadron rushed to the site as part of the rehearsal and completely doused the bunker with an extinguisher. Needless to say, all the commission members, fully soaked by accident, were not too happy."¹³¹

On the afternoon of May 6, the R-7 (product 8K71 number M1-5) was moved once again to the pad, this time escorted on foot by Ryabikov, Korolev, Nedelin, and others in a ceremonial and solemn act that would become common for future launches."¹³² Two days later, the State Commission formally met to set the first launch window between the 13th and 18th of the month. The only major problems were some communications difficulties with the center at the target site near the Klyuchevskhaya-Sopka volcano in Kamchatka. Controllers faced other major problems in the following days: there was a guidance system problem as a result of a loose screw on the 11th and a more serious electrical supply malfunction the following day during a rehearsal launch."¹³³ Having rectified these problems, the State Commission met on the night of the 14th to approve the first launch between 1400 and 1700 hours, Moscow Time, the following day.¹³⁴ There were several reasons for the time slot selection. The launch time had to be during daylight hours for local optical tracking. The reentry over Kamchatka peninsula of the

129. Council of Veterans of the Baikonur Cosmodrome. *Proryv v kosmos*. p. 90; Villain, ed., *Baikonour*. p. 55; Varfolomeyev. "Soviet Rocketry that Conquered Space. Part 1": Mozzhorin, et al., eds., *Nachalo kosmicheskoy ery* p. 57. Each station consisted of a set of buildings for equipment and staff accommodations. The equipment was composed of telemetry, tracking, and time code receivers, which were powered by an independent power generator. In the total Range Measurement Complex in early 1957, there were twelve Binokl tracking devices, eight Irtysh interferometers, ten KT-50 cinetelescopes, two KST-80 movie telescopes, three cinetheodolites, and various other smaller instruments.

130. Villain, ed., *Baikonour* p. 27; Maksimov, "Heat, Water, and Red Buttons". Romanov, *Korolev*. pp. 268-69; Lardier, *L'Astronautique Soviétique* p. 92.

131. Mozzhorin, et al., eds., *Nachalo kosmicheskoy ery*. pp. 134-35.

132. Colovanov, *Korolev*. p. 503. Articles M1-1 to M1-4 were ground-test versions.

133. Villain, ed., *Baikonour*, p. 27; Maksimov, "The First Launch From Baikonur."

134. Local time was three hours ahead of Moscow Time.

dummy warhead had to be observed in the night sky. Finally, the launch had to occur as close to nighttime as possible so as to prevent observation by U.S. optical tracking stations.

Fueling began on the R-7 at 0400 hours Moscow Time, on May 15, under the direction of Georgiy M. Crechko, a twenty-six-year-old engineer from OKB-1 who would fly into space from the same site eighteen years later. The process was quite a grueling ordeal and something to which neither the artillery men nor the engineers particularly looked forward. The hardest part was handling liquid oxygen (LOX), which was maintained at a temperature of minus 190 degrees Centigrade. The oxidizer could not be pumped all at once into the missile because the sudden change in temperature would have caused undesirable structural changes in the missile. Thus, a little amount was transferred to wash and chill the tanks of the five boosters. Only after this could pad workers fill the missile with the bulk of the LOX. Even after complete fueling, the LOX hoses were kept attached to the rocket to continually compensate for the change to gaseous state of the LOX in the hot temperatures in Kazakhstan. The entire process of fueling for the initial variant took close to five hours."

Tensions were high during launch day, and there was a major altercation between Colonel Aleksandr A. Maksimov, the secretary of the State Commission, and Korolev, when the former detected a large oxygen leak at the base of the rocket. As more and more individuals began to congregate at the pad, Korolev lost his temper and began to demand to Chairman Ryabikov that Maksimov be immediately taken off the pad area for insubordination. The matter was eventually resolved when Korolev admitted that there was in fact a leak: he apologized in front of the entire commission to Maksimov. The leak was repaired quickly, and launch preparations continued."

The launch took place at 1901 hours Moscow Time on May 15, 1957. Deputy Chief Designer Voskresenskiy and Lt. Colonel Nosov supervised the launch sequence from a bunker 300 meters from the pad." The launch pad's "petal" structure performed flawlessly, and the rocket lifted gracefully into the sky. The expectations of the State Commission turned sour when incoming telemetry indicated that the engine in one of the strap-ons (Blok D) had cut off at T+98 seconds. Engineers later discovered that the entire strap-on had broken away from the central core, following which the missile disintegrated, with various parts landing as far away as 400 kilometers from the launch site. Chief Designer Bogomolov, responsible for the Tral telemetry system for the booster, had continued to shout until almost 300 seconds that all was well because signals were still coming in, but Korolev intuitively knew that the rocket was going nowhere. "We wanted to surprise



The first R-7 ICBM shown on the single launch pad at site 1 at Tyura-Tam in early 1957. Note the "tulip" launch structure around the base of the rocket. Later operational models of the rocket had a different payload fairing (copyright Steven Zaloga)

135 Zaloga, *Target America*, p. 144

136 Mozzhorin, et al., eds., *Dorogi v kosmos* I, p. 114; Villain, ed., *Baikonour*, pp. 29-30

137 The launch button for this first launch from Tyura-Tam was pressed by thirty-three-year-old Lt. Colonel Ye. I. Ostashev, the chief of the First Testing Directorate of NIIP-5. One source states that the launch was at 1905 hours Moscow Time. See Maksimov, "The First Launch From Baikonur."

the world, but the rocket is lying on the ground 300 kilometers from here," he was quoted as saying.¹³⁸ An extensive investigation later revealed that a fuel leak in the Blok D engine's pump outlet, combined with the heat from the neighboring engines, had led to a fire that had literally engulfed the booster almost from launch.¹³⁹

Khrushchev was evidently disappointed by the result. Although he was keenly interested in the proceedings at Tyura-Tam, he was careful enough to let Ryabikov, Korolev, and Nedelin do their jobs without interference from the higher-ups. He only spoke to Korolev once prior to the launch. He told his son: "If there is any need, Korolev will call me, that's how we arranged it."¹⁴⁰ On the evening of May 15, when the bad news was relayed to him, Khrushchev was silent and pensive, recognizing that accidents were inevitable in such complex projects. The failure took a more serious toll with the engineers back in Kazakhstan. Korolev's deputy Voskresenskiy was severely ill immediately following the failure, and Korolev sent him back to Moscow along with Chief Designers Barmin and Pilyugin. Most members of the State Commission also returned to their duties in Moscow until preparations could be made for a second attempt, leaving Korolev to direct the accident investigation and preparations for a second launch. The fifty-year-old Korolev was not in good health: he had a bad sore throat and had to take penicillin shots several times. His letters to his wife at the time were punctuated with music full of doubt and frustration:

When things are going badly, I have fewer "friends." . . . My frame of mind is bad. I will not hide it, it is very difficult to get through our failures. . . . There is a state of alarm and worry. . . . It is a hot 55 degrees here.¹⁴¹

The second R-7 vehicle, 8K71 number M 1-6, arrived at the pad in early June after new heat-deflecting shields had been installed in the tail section of the missile. During a launch attempt on June 9, there was a sudden abort after the launch command—a problem traced to a nitrogen valve that had remained in the closed position instead of open. The exact same thing occurred on another attempt the following day. A final attempt at launch on June 11 also ended in a launch abort. Just after the abort, the entire area was drenched in a tropical rainstorm, which flooded the basement of several buildings, including the Assembly-Testing Building at site 2. Luckily, military personnel were able to save almost all of the valuable equipment, some simply by drying out in the Sun.¹⁴²

As the engineers pored over telemetry, they determined one of the causes for the abort relatively quickly: yet another valve was left in a wrong position. It was clear that OKB-1 was to blame for the incorrect assembly, but Korolev tried every trick he could think of to obscure the fact that it was one of his employees who had made the egregious error. Although Korolev was magnanimous and fair in his technical evaluations, he was not, by any means, willing to take the blame when it was a case of his design bureau over another. His usual strategy in such situations would be to either cloud the problem with double-talk or force Glushko or Pilyugin to admit to errors. If an accident commission had to be established to address the issue, he always sent either Mishin or Voskresenskiy to defend OKB-1, preferring to remain "above the

138. Mozzhorin, et al., eds., *Nachalo kosmicheskoy ery*, pp. 20, 58, 77; Council of Veterans of the Baykonur Cosmodrome. *Proryu v kosmos*, p. 173.

139. Mozzhorin, et al., eds., *Nachalo kosmicheskoy ery*, p. 77. Some sources suggest that the failure was caused by a rupture in a nitrogen pipe at T+103.6 seconds. See A. A. Maksimov, "The Results of the First Launch From Baykonur" (English title), *Zemlya i useennaya no 2* (March–April 1991) 63–67.

140. Khrushchev, *Nikita Khrushchev tom 1*, p. 287.

141. Colovanov, "The Beginning of the Space Era"

142. Council of Veterans of the Baykonur Cosmodrome. *Proryu v kosmos*, pp. 21, 173.

battle." This time, none of those tactics worked. Ryabikov was too smart for that, reading through the technical jargon that Korolev had used to obfuscate OKB-1's role in the valve failure. Ryabikov reportedly told Korolev. "What a cunning man you are. Sergey Pavlovich! So much stink about what might have been caused by others. and so much perfume for your own shit. . . ." ¹⁴³

After an in-depth investigation, a third rocket, 8K71 number MI-7, was moved to the pad for launch at 1553 hours on July 12. This time, the missile lifted off into the sky to the cheers of observers. The euphoria evaporated when at T+33 seconds, all four strap-ons spuriously separated from the core because of a rapid rotation around the longitudinal axis.¹⁴⁴

The days following this failure were the lowest point for Korolev and his associates. Suddenly, everything for which they had labored over three years had been put into doubt. There was severe criticism from higher officials and even talk of curtailing the entire program. For Korolev, the headaches were compounded by the cumulative delays of his Simple Satellite project. He had originally planned for an orbital launch before the beginning of the IGY. After a month into the IGY, the R-7 had not flown a successful mission. His dreams, his position, and his status were all in jeopardy, and this began to affect his temperament. In mid-June, he wrote to his wife. "Things are not going very well again," adding with a note of optimism. "Here, right here and now, we must strive for the solution we need!" By July, things began to deteriorate. On the 8th, he wrote. "We are working very hard." but after the second launch failure, he wrote on the 23rd. "Things are very, very bad." ¹⁴⁵ One of Korolev's biographers wrote in 1987, "In all the postwar years, no days were more painful, difficult, or tense for Sergey Pavlovich Korolev than those of that hot summer of 1957." ¹⁴⁶ At this point, it seems that had abandoned his old ways of pitting design bureau against design bureau and genuinely asked for cooperation. Anatoliy A. Abramov, the senior designer at OKB-1 responsible for launch complexes, later recalled:

Now, if ever, was the time to despair, to lose faith in the whole program. However S. P. Korolev's composure and the absence of any attempt to find "scapegoats" made people realize that we had embarked on a new level of scientific-technical complexity where no one had gone before. To have fallen into confusion or become mired in apportioning blame would have destroyed the team, its unity and self-confidence. The weight of responsibility resting on S. P. Korolev's shoulders was enormous, especially when you consider that he had still not been formally rehabilitated [after his imprisonment]. Arrest, prison and exile were still fresh in his mind. There were, moreover, certain people gossiping behind his back about the missile being conceptually flawed on the premise that the 32 parallel combustion chambers could never be made to operate simultaneously and reliably. ¹⁴⁷

Another R-7, 8K71 number MI-8, was brought to the pad, this one lovingly prepared with the utmost care. The rocket successfully lifted off the pad at site 1 at 1515 hours Moscow Time on August 21, 1957. To the delight of the controllers, all the main engines, all the combustion chambers, the four strap-ons, the launch complex, and the hybrid guidance system—all of it—worked with clockwork precision. The missile and its payload flew 6,500 kilometers, and the warhead entered the atmosphere over the target point at Kamchatka. The only damper on the mission came when the specially constructed heat shield for the dummy warhead disintegrated.

¹⁴³ Golovanov *Korolev* pp 504–06

¹⁴⁴ Mozzhorin *et al* eds *Nachalo kosmicheskoy ery* p 21 Villain ed *Baikonour* p 31

¹⁴⁵ Colovanov "The Beginning of the Space Era"

¹⁴⁶ *Ibid*

¹⁴⁷ Mozzhorin *et al* eds *Nachalo kosmicheskoy ery* p 21

ed at an altitude of ten kilometers because of excessive thermodynamic forces. Despite the unfortunate end, the R-7 had finally flown, vindicating the hopes of thousands of engineers who had invested so much in it. Korolev was so subsumed by euphoria that he stayed awake until three in the morning, speaking to his deputies and aides about the great possibilities that had opened up, about the future, and mostly about his artificial satellite.¹⁴⁸ As for the missile, a quickly dispatched search party of approximately 500 men spent almost a whole week gathering the remains of the dummy warhead and its thermal coating.

It was only after the search party returned that the State Commission wrote up an official communique on the launch—a statement that was published in the Soviet media. It was extremely unusual for Soviet authorities to publicize successes in any military field, and this particular anomaly can perhaps be explained by the fact that the press release was aimed as much at the United States as it was at Khrushchev's own opponents after the dangerous "Anti-Party Croup" had nearly wrested power from him during the summer of 1957. The communique included the following:

A few days ago a super-long-range, intercontinental multistage ballistic *missile* was launched. The tests of the missile were successful: they fully confirmed the correctness of the calculations and the selected design. *The* flight of the missile took place at a *very* great, hitherto unattained, altitude. Covering an enormous distance in a short time, the missile hit the assigned region. The results obtained show that there is the possibility of launching missiles into any region of the terrestrial globe. The solution of the problem of creating intercontinental ballistic missiles will make it possible to reach remote regions without resorting to strategic aviation, which at the present time is *vulnerable* to modern means of anti-aircraft defense.¹⁴⁹

Clearly, it did not have the intended effect on the U.S. public or media, because, for the most part, little attention was given it. Those who did pay attention spoke only to dismiss the claim—a stance justified partly by the black hole of information on Soviet ballistic missiles in the open press. It would take thirty-eight more days before the entire world would take notice that a new age had arrived, heralded by that same ICBM.

Sputnik

Work on the Simple Satellite PS-I had continued at an uneven pace since the development of the object began in November 1956. Between March and August 1957, engineers carried out computations to select and refine the trajectory of the launch vehicle and the satellite during launch. These enormously complicated computations for the R-7 program were initially done by hand using electrical arithrometers and six-digit trigonometric tables. When more complex calculations were required, the engineers at OKB-I were offered the use of a "real" computer recently installed at the premises of the Department of Applied Mathematics at Keldysh's request. The gigantic machine filled up a huge room and may have been the fastest computer in the Soviet Union in the late 1950s; it could perform 10,000 operations per second, a remarkable capability for Soviet computing machines of the time."¹⁵⁰

¹⁴⁸ Golovanov, "The Beginning of the Space Era", Colovanov. *Korolev*, p. 514; Council of Veterans of the Baykonur Cosmodrome. *Proryv u kosmos*, pp. 25, 174; Villain, ed., *Baikonour*, p. 31.

¹⁴⁹ "Report on Intercontinental Ballistic Missile" (English title), *Pravda*, August 27, 1957. A complete English translation of the press release is included in Krieger, *Behind the Sputniks*, pp. 233–34.

¹⁵⁰ Ishlinskiy, ed., *Akademik S. P. Korolev*, p. 447, V. Lysenko, ed., *Three Paces Beyond the Horizon* (Moscow: Mir Publishers, 1989), p. 58.

Engineers, scientists, and military officers expended a major effort in creating a ground infrastructure to track and make contact not only with the PS-I, but also with the much more complex Object D, still awaiting launch in 1958. After fierce competition between the Academy of Sciences and NII-4 in the Ministry of Defense for the contract to build the tracking, telemetry, and command network for the satellite, the latter establishment took on the job, in addition to its duties in connection with the R-7 tracking network.¹⁵¹ This was the beginning of the creation of the so-called Command-Measurement Complex (KIK), which has served every single piloted, interplanetary, scientific, and military space mission from 1957 to the present time. Overseen by NII-4 Deputy Director Mozzhorin. KIK initially comprised seven major stations spread all across the country at Tyura-Tam. Makat. Sary-Shagan. Yeniseysk. Iskhup, Yelizovo, and Klyuchi.¹⁵² All the tracking and telemetry data were relayed to a new Coordination-Computation Center, established at NII-4's headquarters in Moscow in early 1957, under the command of Pavel A. Agadzhanov, who was personally responsible for overseeing the tracking of all satellites in the early space program. This center eventually became part of the larger KIK when the KIK command center was established on July 12, 1957.¹⁵³ An analogous group was also stationed at Tyura-Tam to support the launch of satellites. Although Soviet sources suggest that the center and KIK were primarily designed and built to support operations of Object D, it is clear that the primary *raison d'être* was to support future operations of military satellites.

Work on the Simple Satellite seems to have slowed down somewhat during the intense preparations for the R-7 launch in the summer 1957. There were many debates on the shape of the first satellite, with most senior OKB-1 designers preferring a conical form because it fit well with the nose cone of the rocket. At a meeting early in the year, Korolev had a change-of-heart and suggested a metal sphere at least one meter in diameter.¹⁵⁴ There were six major guidelines followed in the construction of the PS I:

- The satellite would have to be of maximum simplicity and reliability while keeping in mind that methods used for the spacecraft would be used in future projects.
- The body of the satellite would be spherical to determine atmospheric density in its path.
- The satellite would be equipped with radio equipment working on at least two wavelengths of sufficient power to be tracked by amateurs and to obtain data on the propagation of radio waves through the atmosphere.
- The antennas would be designed so as not to affect the intensity of the radio signals because of spinning.
- The power sources would comprise on-board chemical batteries, ensuring work for two to three weeks.
- The attachment of the satellite to the core stage would be designed in such a way as to minimize the possibility of a separation failure.

¹⁵¹ Mozzhorin et al eds *Nachalo kosmicheskoy ery* p 266 The Soviet government issued an official decree on September 3, 1956 for the creation of the ground tracking network

¹⁵² Many of the major participants involved in the creation of KIK are named in B. A. Pokrovskiy "Zarya" — *pozyunoye zemni* (Moscow: Moskovskiy rabochiy, 1987) pp 58-70. They included numerous individuals who went on to powerful positions in the Soviet space program: A. I. Sokolov (NII-4 Director), G. A. Tyulin (NII-4 First Deputy Director), P. A. Agadzhanov, I. A. Artelshchikov, I. K. Bazhinov, A. V. Brykov, Yu. V. Devyatkov, P. E. Eliasberg, V. T. Dolgov, G. I. Levin, M. P. Likhachev, G. S. Narimanov, Ye. V. Yakovlev, and I. M. Yatsunskiy. Bazhinov, Brykov, and Yatsunskiy were members of Tikhonravov's original satellite research group at NII-4, but they were not transferred to OKB-1 in 1956 like most of their associates. The Pokrovskiy text is a detailed exposition on the history of KIK. Some more details were added in Mozzhorin et al eds *Nachalo kosmicheskoy ery*.

¹⁵³ Pokrovskiy "Zarya" — *pozyunoye zemni* pp 75-76. Maksimov ed *Raketnyye voyska strategicheskogo naznacheniya* p 49. Mozzhorin et al eds *Nachalo kosmicheskoy ery* p 310. The first commander of the KIK center (TsKIK) was Maj. General A. A. Vitruk.

¹⁵⁴ I. Minyuk and G. Vetrov "Fantasy and Reality" (English title) *Aviatsiya i kosmonavtika* no. 9 (September 1987) 46-47.

The five primary scientific objectives of the mission were to:

- Test the method of placing an artificial satellite into Earth orbit
- Provide information on the density of the atmosphere by calculating its lifetime in orbit
- Test radio and optical methods of orbital tracking
- Determine the effects of radio wave propagation through the atmosphere
- Check principles of pressurization used on the satellite"

The satellite as it eventually emerged was a pressurized sphere, fifty-eight centimeters in diameter, made of an aluminum alloy. The sphere was constructed by combining two hemispherical casings together. The pressurized internal volume of the sphere was filled with nitrogen at 1.3 atmospheres, which maintained an electro-chemical source of power (three silver-zinc batteries), two D-200 radio transmitters, a DTK-34 thermo-regulation system, a ventilation system, a communications system, temperature and pressure transmitters, and associated wiring. The two radio transmitters operated at frequencies of 20.005 and 40.002 megacycles at wavelengths of one and a half and seven and a half meters, respectively. The signals on both the frequencies were spurts lasting 0.2 to 0.6 seconds, and they carried information on the pressure and temperature inside the satellite. They provided the famous "beep-beep" sound to the transmissions. The antenna system comprised four rods, two with a length of 2.4 meters each and the remaining two with a length of 2.9 meters each, all of which would spring open into their unfurled position once the satellite was in orbit. Engineers had conducted tests of this radio system as early as May 5, 1957, using a helicopter and a ground station. The total mass of the satellite was 83.6 kilograms, of which fifty-one kilograms represented the power source. The "lead designer" for the PS-I was Mikhail S. Khomyakov; Oleg G. Ivanovskiy served as his deputy.¹⁵⁶

Korolev, of course, kept close tabs on the development of the PS-I and continuously made sure that the spherical satellite was kept spotlessly clean and shiny, not only for its reflective qualities, but also for its overall aesthetic beauty. On one occasion, he flew into a rage at a junior assembly shop worker for doing a poor job on the outer surface of a mock-up of the satellite. "This ball will be exhibited in museums!," he shouted." Deputy Chief Designer Bushuyev telephoned Korolev at Tyura-Tam on June 24 to inform him that he had just signed the document specifying the final configuration of the satellite. Actual construction took place in August. The launch vehicle earmarked for the satellite was a slightly updated version of the basic 8K71 ICBM variant, renamed the 8K71PS.

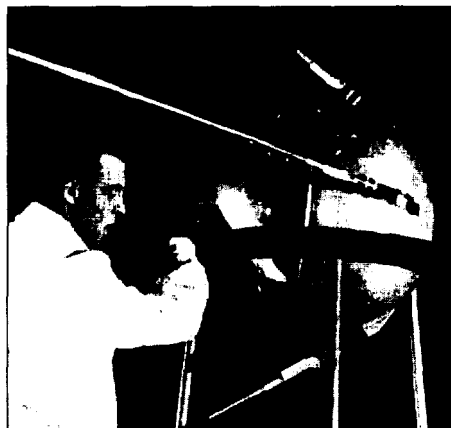

The PS-I satellite is shown here on a rigging truck in the assembly shop in the fall of 1957 as a technician puts finishing touches on it

155. M. K. Tikhonravov, "The Creation of the First Artificial Earth Satellite: Some Historical Details." *Journal of the British Interplanetary Society* 47 (May 1994): 191-94.

156. *Ibid.*: Kustova, ed., *Ot peruogo Sputnika*, p. 37; Villain, ed., *Baikonour*, p. 26; Colovanov, Korolev, p. 537. O G. Ivanovskiy, *Naperekor zemnomu pntyazhenyu* (Moscow: Politicheskoy literatury, 1988), pp 167-69.

157. Mikhail Florianskiy, "October 4—For the First Time in the World," *Moscow News Supplement* 40 (1987)

The modifications included omitting the 300-kilogram radio package from the top of the core booster, changing the burn times of the main engines, removing a vibration measurement system, using a special nozzle system to separate the booster from the satellite installed at the top of the core stage, and installing a completely new payload shroud and container, which replaced the warhead configuration.¹⁵⁸ The length of the booster with the new shroud was 29.167 meters, almost four meters shorter than the ICBM version. Because there was some doubt as to whether ground observers would be able to observe the tiny satellite in orbit, Korolev ensured that the central core of the launch vehicle was sufficiently reflective. Academician Vladimir A. Kotelnikov, the Director of the Institute of Radio-technology and Electronics at the Academy of Sciences, had one of his scientists develop an angular reflector for this purpose, which was installed on the booster core."

Apart from competition from the United States, Korolev had to unexpectedly address a different kind of threat at the time, one from within the Soviet Union in the person of Chief Designer Mikhail K. Yangel of OKB-586. In the first quarter of 1957, Yangel's design bureau at Dnepropetrovsk, on orders from Ustinov, had begun a study to explore the possibility of modifying its R-12 intermediate-range ballistic missile for a satellite launch.¹⁵⁹ The missile itself, fueled by storable hypergolic propellants, unlike the R-7, was the focus of a five-year-long development program, at first under Korolev's tutelage, but later transferred to Dnepropetrovsk. Prodded by the unending delays in the R-7 program, Yangel evaluated "the possibility of the immediate launch of a similar satellite [as Korolev's] using the simplest of booster rockets based on the strategic R-12 missile."¹⁶⁰ Although analysis proved that a hastily modified two-stage R-12 could be used for this goal, it did not seem likely that a first launch could be carried out prior to either the R-7 or the Americans. To Korolev's relief, the plan was shelved. The R-12 meanwhile began a successful flight test program on June 22, 1957, from Kapustin Yar, at the very same time that Korolev was watching his R-7s blow up in the air.¹⁶¹ Ironically, Yangel *did* end up using the R-12 as the basis for a satellite launch vehicle, but that would not be until the early 1960s.

The Council of Ministers had formally approved the Simple Satellite program in February 1957. With one R-7 success under his belt, Korolev needed final permission from the State Commission to proceed with an orbital launch. Despite the official governmental sanction, it seems that this process was fraught with difficulty, suggesting that even at this late stage, there were individuals on the commission who were not interested in the satellite attempt. At a State Commission meeting soon after the August launch, Korolev formally asked for permission to launch a satellite if a second R-7 successfully flew in early September. For many of the members, while they were aware of the Object D project, the existence of the PS-1 effort was a com-

158 Varfolomeyev. "Soviet Rocketry that Conquered Space Part I": Keldysh, ed., *Tuorcheskoye naslediyе Akademika Sergeya Pavlovicha Koroleva*, p. 365, Mozzhorin, et al., eds., *Nachalo kosmicheskoyery*, pp. 60-61

159 Ishlinskiy, ed., *AkademiK S P Koroleu*, p. 459. The scientist in question was V. M. Vakhnin

160. Pappo-Korystin, Platonov, and Pashchenko. *Dnepropetrovskiy raketno-kosmicheskii tsestr*, p. 60; S. N. Konyukhov and V. A. Pashchenko. "History of Space Launch Vehicles Development," presented at the 46th International Astronautical Congress, IAA-95-IAA 2.2.09, Oslo, Norway, October 2-6, 1995. The range of the missile was about 2,000 kilometers.

161 Biryukov. "From the History of Space Science." Author's emphasis. Confusingly, Korolev's own OKB-1 had also examined the possibility of a "light" alternative satellite launch vehicle to the R-7. In late 1957, a department at OKB-1 had begun studying the possibility of a two-stage vehicle, the first using the R-5M and the second using the R-11M, as a launcher. The study, finished on August 9, 1957, proved that this multistage booster would not be able to launch a forty- to fifty-kilogram payload into Earth orbit. OKB-1 also studied a possible satellite launch vehicle using simply the core of the R-7. See Semenov, ed., *Raketno-Kosmicheskaya Korporatsiya*, p. 61; Vetrov. "The First Satellite": Afanasyev. *R-12: Sandalovoye derevo*, pp. 17-18.

162 Sergeyev, ed., *Khronika osnovnykh sobyitii istorii*, p. 36. The series ended in December 1958, and the missile was declared operational on March 4, 1959. The U.S. Department of Defense designation for the R-12 was the SS-4, while the North Atlantic Treaty Organization (NATO) later named the missile "Sandal."

CHALLENGE TO APOLLO

plete surprise. Convincing the commission proved to be much harder than expected, and the meeting ended in fierce arguments and recriminations. Not easily turned away, Korolev tried again at a second session soon after, this time using a political ploy: "I propose let us put the question of national priority in launching the world's first artificial Earth satellite to the Presidium of the Central Committee of the Communist Party. Let them settle it." "It worked. None of the members wanted to take the blame for a potential miscalculation, and Korolev got what he wanted. A final document for launch. "The Program for Carrying out a Test Launch of a Simple Unoriented ISZ (Object PS) Using the Product 8K71PS." was later signed by Ryabikov (Special Committee), Nedelin (Ministry of Defense), Ustinov (Ministry of Defense Industries), Kalmykov (Ministry of Radio-Technical Industry), and Nesmeyanov (Academy of Sciences)."

The subsequent launch of the R-7 on September 7 was as successful as the one in August. and the missile. 8K71 number M1-9. flew across the Soviet Union before depositing its dummy warhead in Kamchatka. Like the previous time, the warhead container disintegrated." For the engineers working on the satellite, this was of minor significance. because the flight profile on the orbital mission would be different. In the summer. Korolev. Clushko, and the other chief designers had informally targeted the satellite launch for the 100th anniversary of Tsiolkovskiy's birth on September 17th, but achieving this date proved increasingly unrealistic. Instead of being at Tyura-Tam for a space launch on that day. Korolev and Clushko were both in attendance at the Pillard Hall of the Palace of Unions in Moscow for a special celebration of the great visionary's birthday. In a long speech to the distinguished audience. Korolev, whose real job was not revealed, predicted that "in the nearest future the first test launches of artificial satellites of the Earth with scientific goals will take place in the USSR and the USA." "The audience, of course, had little evidence to suspect that Korolev's pronouncement was not simply a vague prediction for an indefinite time.

On September 20. Korolev was in Moscow for a meeting of the State Commission for the PS-I launch." Chairman Ryabikov, Marshal Nedelin. Korolev, and Keldysh were the principal participants, and they established October 6 as the launch's target date based on the pace of preparations. At the same meeting, they decided to publicly announce the launch of the PS-I after the completion of the first orbit. Ryabikov wrote up a communique to this effect on September 23.¹⁶³ The frequencies for tracking by amateurs had already been announced earlier in the year in issues of the journal *Radio*, although details of the program had obviously been omitted. Korolev meanwhile flew into Tyura-Tam on September 29, staying in a small house close to the primary activity area near site 2.

163 Council of Veterans of the Baykonur Cosmodrome, *Proryv v kosmos*. pp. 29-30.

164. Semenov, ed. *Raketno-Kosmicheskaya Korporatsiya*. p. 90. "ISZ" is the Russian acronym for "Artificial Satellite of the Earth."

165. Biryukov. "Materials From the Biographical Chronicles." p. 238. Lardier. *L'Astronautique Soviétique* p. 93; Golovanov. Korolev, p. 517

166. S. P. Korolev, "On the Practical Significance of K. E. Tsiolkovskiy's Proposals in the Field of Rocket Technology" (English title). in B. V. Raushenbakh, ed., *Issledovaniya po istorii i teorii razvitiya aviatsionnoy i raketno-kosmicheskoy nauki i tekhniki* (Moscow: Nauka, 1981). p. 40. This is a complete version of his speech. An abridged English translation has been reproduced in Institute of the History of Natural Sciences and Technology, *History of the USSR. New Research 5 Yuri Gagarin. To Mark the 25th Anniversary of the First Manned Space Flight* (Moscow: Social Sciences Today, 1986). pp. 48-63. Note that the latter does not include the above quote.

167. The State Commission for the Launch of the First Satellite may have been slightly expanded from the original R-7 State Commission. See Yu. A. Skopinskiy, "State Acceptance of the Space Program: Thirty Years of Work" (English title). *Zemlya i usemennaya* no. 5 (September-October 1988): 73-79. Lardier. *L'Astronautique Soviétique*, p. 285

168. Ishinskiy, ed. *Akademik S. P. Korolev*. p. 447; Lardier. *L'Astronautique Soviétique*. pp. 108-09; Kononov, "The Genealogy of Sputnik." pp. 122-23.

The preparations for launching were for the most part uneventful, save for the last-minute replacement of one of the batteries on the flight version of the PS-I. Still apprehensive over a last-minute launch from the United States, Korolev abruptly proposed to the State Commission that the launch be brought forward two days. His concerns were apparently prompted by plans for a conference in Washington, D.C., to be held in early October as part of ICY proceedings. According to Korolev's information, American delegates would present a paper titled "Satellite Over the Planet" on the 6th, the day of the PS-I's scheduled launch. He believed that the presentation was timed to coincide with a hitherto unannounced launch attempt of a U.S. satellite.¹⁶⁹ Local KGB representatives assured Korolev that this was not so, but Korolev was convinced that there would be a launch of an Army Jupiter C on that day. The State Commission buckled under Korolev's wishes and moved the PS-I launch forward by two days to the 4th; Korolev signed the final order for launch at four in the afternoon on the 2nd and sent it to Moscow for approval.¹⁷⁰

The R-7, 8K71PS number MI-PS, was transported and installed on the launch pad in the early morning of October 3, escorted on foot by Korolev, Ryabikov, and other members of the State Commission. Fueling began the following morning at 0545 hours local time under Crechko's supervision. Korolev, although under pressure, remained cautious throughout the proceedings. He told his engineers, "Nobody will hurry us. If you have even the tiniest doubt, we will stop the testing and make the corrections on the satellite. There is still time. . . ."¹⁷¹ Most of the engineers, understandably enough, did not have time to ponder over the historical value or importance of the upcoming event. The PS-I's Deputy Designer Ivanovskiy recalled, "Nobody back then was thinking about the magnitude of what was going on: everyone did his own job, living through its disappointments and joys."¹⁷²

On the night of the 4th, huge flood lights illuminated the launch pad as the engineers in their blockhouse checked off the rocket's systems. In the command bunker, accompanying Korolev were some of the senior members of the State Commission: Ryabikov, Keldysh, Glushko, and Pilyugin, as well as Deputy Chief Designer Voskresenskiy and Lt. Colonel Nosov, the two individuals overseeing all launch operations. Both viewed the launch pad through periscopes as they gave the final orders. Boris S. Chekunov, a young lieutenant in charge of pushing the launch button, later recalled the final moments as the clock ticked past midnight local time:

When only a few minutes remained until liftoff, Korolev nodded to his deputy Voskresenskiy. The operators froze, awaiting the final order Aleksandr Nosov, the chief of the launch control team, stood at the periscope. He could see the whole pad. "One minute to go!" he called."

OKB-I senior engineer Shabarov, also in the bunker, adds:

With the exception of the operators, everybody was standing. Only N. A. Pilyugin and S. P. Korolev were allowed to sit down. The launch director [Nosov] began issuing commands. I kept an eye on S. P. Korolev. He seemed nervous although he tried to conceal it. He was carefully examining the readings of the various instruments without missing any nuance of our body language and tone of voice. If anybody raised their voice or showed signs of nervousness, Korolev was instantly on the alert to see what was going on.¹⁷⁴

169 Golovanov Korolev pp 537-38

170 This document was not actually signed until the morning of the launch See Ishlinskiy ed Akademrk S P Korolev p 448

171 Golovanov "The Beginning of the Space Era" Mozzhorin et al eds Nachalo kosmrcheskoy ery p 63

172 Colovanov "The Beginning of the Space Era "

173 Borisenko and Romanov Where All Roads into Space Begm p 66

174 Mozzhorin et al eds . Nachalo kosmrcheskoy ery p 63

The seconds counted down to zero, and Nosov shouted the command for liftoff. Chekunov immediately pressed the launch button. At exactly 2228 hours, 34 seconds, Moscow Time, the engines ignited, and the 272.830-kilogram booster lifted off the pad in a blaze of light and smoke. The five engines of the R-7 generated about 398 tons of thrust at launch. Although the rocket lifted off gracefully, there were problems. Delays in the firing of several engines could have easily resulted in a launch abort. Second, at T+16 seconds, the Tank Emptying System malfunctioned, resulting in a higher than normal kerosene consumption. A turbine failure because of this resulted in main engine cutoff one second prior to the planned moment.¹⁷⁵ Separation from the core stage, however, occurred successfully at T+324.5 seconds, and the 83.6-kilogram PS-1 successfully fell into a free-fall elliptical trajectory. The first human-made object had entered orbit around Earth. A new era had begun.

With most State Commission members still in the bunker, engineers at Tyura-Tam awaited confirmation of orbit insertion from the PS-1 in a van set up about 800 meters from the launch pad. As a huge crowd waited outside the van, radio operator Vyecheslav I. Lappo, from Nil-885, who had personally designed the on-board transmitters, sat expectantly for the first signal. There was cheering once the Kamchatka station picked up signals from the satellite, but Korolev cut everybody off: "Hold off on the celebrations. The station people could be mistaken. Let's judge the signals for ourselves when the satellite comes back after its first orbit around the Earth."¹⁷⁶ Eventually the distinct "beep-beep-beep" of the craft came in clearly over the radio waves, and the crowd began to celebrate. Chief Designer Ryazanskiy, who was at the van, immediately telephoned Korolev in the bunker. The ballistics experts at the Coordination-Computation Center back in Moscow had determined that the satellite was in an orbit with a perigee of 228 kilometers and an apogee of 947 kilometers, the latter about eighty kilometers lower than planned because of the early engine cutoff. The inclination of the orbit to Earth's equator was 65.6 degrees, while the orbital period was 96.17 minutes.¹⁷⁷ Experts at the center had also determined that the satellite was slowly losing altitude, but State Commission Chairman Ryabikov waited until the second orbit was over prior to telephoning the Soviet leader.

According to conventional wisdom, Khrushchev's reaction to the launch was unusually subdued for an event of such magnitude, indicating that he, like many others, did not immediately grasp the true propaganda effect of such a historic moment. He told the press:

When the satellite was launched, they phoned me that the rocket had taken the right course and that the satellite was already revolving around the earth. I congratulated the entire group of engineers and technicians on this outstanding achievement and calmly went to bed.¹⁷⁸

Khrushchev's son, however, recalls that his father's reaction was a little more enthused. The older Khrushchev at the time was on visit to Kiev to discuss economic issues with the Ukrainian Party leadership. Around 11:00 p.m., these negotiations were interrupted by a telephone call. Khrushchev quietly took the call, then returned back to his discussions without saying anything. Eventually, as his son recalled, the news was too difficult to keep under wraps:

175 Ishlinskiy ed *Akademik S P Korolev* pp 448-464 B Ye Chertok *Rakety i lyudi Fili Podlipki Tyuratam* (Moscow Mashinostroyeniye 1996) p 197

176 Mozzhorin et al eds *Nachalo kosmicheskoy ery* p 64

177 Ishlinskiy ed *Akademik S P Korolev* p 464

178 Daniloff *The Kremlin and the Cosmos* pp 65-66

He finally couldn't resist saying [to the Ukrainian officials]: "I can tell you some very pleasant and important news. Korolev just called (at this point he acquired a secretive look). He's one of our missile designers. Remember not to mention his name—it's classified. So. Korolev has just reported that today, a little while ago, an artificial satellite of the Earth was launched."¹⁷⁹

The Soviet leader was animated the rest of the evening, speaking in glowing terms about the new era of missiles, which could "demonstrate the advantages of socialism in actual practice" to the Americans.

For the engineers and scientists responsible for the achievement. October 5 was a day like no other. Korolev's deputy Shabarov ordered the chief of the dispatch office to hand out one teapot of alcohol to each man at the firing range. During the latter part of the day, there was a celebration in a small movie theater in Tyura-Tam; Ryabikov made a speech congratulating all, followed by Korolev and Keldysh. It was only later, after nightfall, that Korolev and a small group of his co-workers took off in an Il-14 aircraft from Tyura-Tam to head for Moscow. Most were exhausted and slept through the flight, having spent the previous night without any rest. After takeoff, the pilot of the airplane, Tolya Yesenin, came out of the cockpit and bent over Korolev's seat to tell him that "the whole world was abuzz" with the launch. Korolev quickly got up and went into the pilot's cabin. Returning back to the passenger's area, he announced gleefully to everybody, "Well comrades, you can't imagine—the whole world is talking about our satellite," adding with a huge smile. "It seems that we have caused quite a stir. . . ."¹⁸⁰

On the morning of October 5, the official Soviet news agency TASS released the communique Ryabikov had authored. Published in the morning edition of Pravda, it was exceptionally low key and was not the headline of the day:

For several years scientific research and experimental design work have been conducted in the Soviet Union on the creation of artificial satellites. As has already been reported in the press, the first *launching[s]* of the satellites in the USSR were planned for realization in accordance with the scientific research program of the International Geophysical Year. As a result of very intensive work by scientific research institutes and design bureaus the first artificial *satellite* in the world has been created. On October 4, 1957, this first satellite was successfully launched in the USSR. According to *preliminary* data, the carrier rocket has imparted to the satellite the required *orbital* velocity of about 8000 meters per second. At the present time the satellite is describing elliptical trajectories around the earth, and its flight can be observed in the rays of the rising and setting sun with the aid of very *simple* optical instruments (binoculars, telescopes, etc.)¹⁸¹

The Soviet media did not ascribe a specific name for the satellite, generally referring to it as Sputnik, the Russian word for "satellite," often also loosely translated as "fellow traveler."

As the media tumult over Sputnik began to mount in the West, the Soviet leadership began to capitalize on the utter pandemonium pervading the discourse on the satellite in the United States. On October 9, Pravda published a long report detailing the construction and design of the satellite." The parties responsible for this great deed were, of course, not named. Having

179 Khrushchev *Nikita Khrushchev tom 1* pp 337-38

180 Colovanov *Korolev* pp 540-41

181 "Announcement of the First Satellite" (English title) Pravda October 5 1957 p 1. A complete English translation of this announcement is included in Krieger Behnd the *Sputniks* pp 311-12

182 "Report on the First Satellite" (English title). Pravda October 9 1957 p 1. A complete English translation of this article is included in Krieger Behnd the *Sputniks* pp 313-25. This particular article was authored jointly by A. G. Azizyan (Pravda), V. P. Glushko (OKB 456), M. V. Keldysh (OPM MIAN and NII 1), S. P. Korolev (OKB 1), D. Ye. Okhotsimskiy (OPM MIAN), G. A. Skuridin (AN SSSR) and others although none were named

CHALLENGE TO APOLLO

been involved in the defense industry, the real job titles of the members of the Council of Chief Designers had always remained secret, although Tikhonravov and others had freely published under their own names through the 1950s on topics of general interest. This suddenly changed as their names disappeared from official histories. Beginning with the launch of Sputnik, of the major contributors to the success of Sputnik. Korolev, Glushko, and Keldysh were referred in the open press as the Chief Designer of Rocket-Space Systems, the Chief Designer of Rocket Engines, and the Chief Theoretician of Cosmonautics, respectively. The fourth, Tikhonravov, did not even have a pseudonym for himself.

The titles not only hid their identities, but also added an element of enigma to the men behind the world's first space program. New editions of histories of Soviet rocketry published prior to 1957 ceased to carry Korolev's name, and Soviet encyclopedias subsequently listed him as heading a laboratory in an unspecified "machine building" institute in the Soviet Union. Glushko, meanwhile, was said to be laboratory chief at the Moscow Institute of Mineral Fuels.¹⁸³ Korolev, certainly in recognition of the key role he played, was allowed to write in no less an important newspaper as *Prauda*, but under the pseudonym "Professor K. Sergeev." His first article, titled "Research into Cosmic Space," was published on December 12, 1957. Khrushchev claimed at the time that as the years went by, "the photographs and names of these illustrious people will be made public." but that for the moment, "in order to ensure the country's security and the lives of these scientists, engineers, technicians, and other specialists, we cannot yet make known their names or publish their photographs."''

As time went by, the publicity afforded the Soviet space program by its own media became uniquely perverse. One could read countless books and articles on the effort and not learn anything new about the program. Pages and pages would often be filled with supposedly amusing anecdotes about anonymous people without once mentioning a name, a date, a place, or an institution. Although this state of events marginally improved by the end of the 1960s, there were four main elements of the veil of secrecy: plans for future space missions were never mentioned; failures were omitted from historical discussion; the names of engineers and administrators were not mentioned until they were deceased; and the military was never implicated in the operation of the space program. There were, of course, other corollaries, such as the vagueness of details about spacecraft, missions, launching sites, funding, and administrative structure, but by and large, these four elements dominated the reportage of the Soviet space program from its inception in 1957.

The chief designers toiling in anonymity not only had to have their work go unrecognized, but they were often the subject of ironic twists of fate. For example, Academician Sedov, the erstwhile chairman of the Commission for Interplanetary Communications, was allowed to publicly travel and speak prominently concerning the Soviet space program, presumably because he had no direct responsibility or connection with anything in the program. Korolev's engineers would, in fact, joke about the time Korolev invited Sedov to the launch pad at Tyura-Tam to see an R-7 with a satellite on it. Sedov surprised everyone by asking where exactly the satellite was on the rocket. Some, such as Academicians Blagonravov and Vernov, who had peripheral knowledge about the space program were allowed to talk, but as one Russian journalist later wrote, they "were so ensnared by what they had signed about not disclosing governmental secrets, that they uttered only banalities, and thus differed only slightly from the uninitiated [such as Sedov].''

183 Soviet Space Programs 1962-65 Goals and Purposes Achievements Plans and International Implications prepared for the Committee on Aeronautical and Space Sciences U.S. Senate 89th Cong. 2d sess (Washington D.C. U.S. Government Printing Office December 1966) pp. 149-50

184 Ibid pp. 71-72

185 Golovanov Korolev p. 553

One can imagine how Korolev, Glushko, Pilyugin, Barmin, and Tikhonravov must have felt watching Sedov, Blagonravov, and others traveling across the world, giving speeches to awestruck audiences, who believed they were looking at the founders of the Soviet space program. Eventually, the secrecy was loosened, and the names were released. Of the six original chief designers whose names were classified top secret in 1957, all would eventually live to see their names in the press—except one, the founder and instigator of humankind's first step into the cosmos, Sergey Pavlovich Korolev.



CHAPTER FIVE

DESIGNING THE FIRST SPACESHIP

On October 4, 1957, in an imperceptible way, the course of human history changed. In the forty years following that singular event, it is easy to lose sight of the significance of Sputnik. For the first time in history, humans had managed to break free of Earth's atmosphere and loft a modest product of their handiwork into the heavens. There were, of course, more earthly considerations. The Soviet satellite served as a distinct milestone: it moved the Cold War into a new phase—one characterized by the very real possibility of Soviet dominance in the new arena of space, and thus, by extension, on Earth. With only a ball of metal, the Soviets had managed to achieve what they were unable to convey with decades of rhetoric on the virtues of socialism: that the USSR was a power with which to be reckoned. In this climate, the Soviet space program was much more than the sum of its parts. In reality, its parts were very far and few in between. Barring a few isolated proposals, there was, in fact, no Soviet space program in 1957. There were no long-range goals, no governing body for the space program, no financial planning, no agenda, and no direction. This suspension into limbo continued to exist for the next few years, hidden, of course, beneath the pages and pages of Soviet propaganda hailing the glorious benefits of a nationwide effort.

The Immediate Aftermath

The engineers at OKB-1 could be forgiven for hoping for a respite from the relentless months of hard work in support of both the R-7 and the first Sputnik. At the time, Korolev allowed all his key deputies to take a short vacation—the first in many years—to rejuvenate their energies. First Deputy Chief Designer Mishin, Deputy Chief Designer Voskresenskiy, their assistants, and "a group of the main workers" from the Design Bureau were sent off to the seaside resort of Sochi.¹ Korolev, who returned to Moscow on October 5, elected not to take advantage of the break but instead began to play with an ambitious idea to sustain the successes of the new space program. After Korolev's return, Soviet leader Khrushchev immediately called him to find out all the details of the Sputnik launch. During the conversation, Khrushchev asked casually whether Korolev could launch another satellite, possibly in time for the fortieth anniversary of the Great October Socialist Revolution on November 7. Without any hesitation, Korolev suggested that his team could launch a dog. Khrushchev was ecstatic about the idea, stipulating only that the launch had to take place by the holiday. Korolev assured him

¹ A. Tarasov. "Missions in Dreams and Reality" (English title). *Pravda*. October 20, 1989. p. 4

they would do their best to make the deadline.' Khrushchev asked his "right-hand man." Frol R. Kozlov, to handle all logistical issues. The next day, the Central Committee held a meeting in Kozlov's presence, during which the six key chief designers agreed that to facilitate the launch in less than a month, the design of the spacecraft would have to be simplified as much as possible. Kozlov emphasized to Korolev that the launch would have to be in time for the holidays "without fail."² The official order for the launch was issued on October 12, 1957, eight days after the launch of the first Sputnik.

Vacations were immediately cut short as Korolev ordered all his deputies back to Kaliningrad. They would have less than a month to bring the project to fruition. The options available to the engineers were slim: either prepare the biological version of the Object D satellite or create a completely new spacecraft. Because the former was still far from ready, they adopted a plan to make maximal use of the small PS-1 structure used for the first satellite. OKB-1 also had the advantage of a large database of experience in launching dogs and other animals on "vertical" trajectories into the upper atmosphere through the 1950s on modified versions of the R-1, R-2, and R-5 missiles. Engineers took a container originally earmarked for the next launch of the "biological" R-2A missile and used it as a basis for the new satellite, which was designated Simple Satellite No. 2 (PS-2). Once again, Korolev used as few outside organizations as possible. Chief Designer Semyon A. Alekseyev's Plant No. 918 at Tomilino, which specialized in high-altitude pressure suits, provided the suit for the dog, while the Leningrad-based Biofizpribor Special Design Bureau was tasked to build a feeding trough for the animal. Both organizations had participated in the same capacity in the vertical dog launch program of the 1950s. The Experimental Design Bureau of the Moscow Power Institute under Chief Designer Aleksey F. Bogomolov prepared the modest *Tral* ("trawl") radio transmitters for the communication of telemetry on the vital signs of the animal. ³ A slow-scan television system named Seliger was also built to transmit images of the dog in space: it had a capability of 200 lines per frame and ten frames per second.

Technical operations on the construction of the PS-2 formally began on October 10, 1957, just six days after the launch of the first Sputnik. The satellite, as it emerged in the following days, was a small stubby cylindrical container for a single dog, which contained life support systems and instruments for monitoring the life signs of the dog and the internal atmosphere of the capsule. The life support system included a "regeneration unit" containing chemical compounds, which absorbed carbon dioxide and excess water vapor. The system was designed to operate automatically. No provision was made to return the dog from orbit because neither the technology nor the time was available to prepare for such a mission. Doctors expected to put the animal to sleep with an automated injection of poison prior to oxygen depletion in the

2 Yaroslav Golovanov *Korolev: Fakty i mify* (Moscow: Nauka, 1994) pp. 544-45. There are many contradictory accounts of the decision. Most, however, agree that Khrushchev suggested a launch for the holidays and Korolev came up with the idea to put a dog in the satellite. Khrushchev had apparently told the six major chief designers (Barmin, Glushko, Korolev, Kuznetsov, Pilyugin, and Ryazanskiy) at a meeting in early October: "On the 7th of November we will mark the fortieth anniversary of the Great October. It would be a good idea to do something extra." See Col. M. Rebrov, "The Whiteness of Martian Seas" (English title) *Krasnaya zvezda*, March 11, 1989, p. 4.

3 Golovanov, *Korolev*, pp. 547-48. Present at the meeting were Special Committee Chairman V. M. Ryabikov, Committee Deputy Chairman G. N. Pashkov, First Deputy Commander of the Directorate of the Commander of Reactive Armaments (UNRV) Lt. Gen. A. G. Mrykin, and Chief Designers V. P. Barmin, A. F. Bogomolov, S. P. Korolev, N. A. Pilyugin, and M. S. Ryazanskiy, as well as Korolev's "space" Deputy K. D. Bushuyev.

4 *Ibid.*, p. 548. G. Salakhutdinov, "Once More About Space" (English title) *Ogonek* 34 (August 18-25, 1990), 4-5. Yu. A. Mozhorin et al., eds., *Nachalo kosmicheskoyery vospominaniya veteranov raketno kosmicheskoy tekhniki i kosmonavtiki: uypusk utoroy* (Moscow: RNITsKD, 1994), p. 82. A. V. Ponomarev, "2 June—75 Years From the Birth of Academician A. F. Bogomolov (1913)" (English title) *Iz istorii aviatsii i kosmonavtrkt* 59 (1989), 47-50.

life support system. The cylindrical container was crowned by a spherical object, identical in design to the first Sputnik, which housed the radio-telemetry systems, thermal systems, and power sources. A few scientific instruments were attached externally near the top of the booster core. These were for investigations of solar radiation in the ultraviolet and x-ray regions of the spectrum and for the study of cosmic rays. The total mass of the payload was 508.3 kilograms, a significant leap from the modest PS-1. Korolev's engineers designed the payload in such a way that it would remain attached to the central core of the R-7 booster throughout its time in orbit, thus enabling the satellite to use the same telemetry system as the rocket. This not only eliminated the development of a new telemetry system for the dog, but it would also help keep the temperature down in the dog container, a major concern for the designers. By October 18, a new R-7 ICBM for this next launch had been shipped to Tyura-Tam following a series of extensive tests at the assembly plant at Kaliningrad.⁵ Korolev took an Aeroflot flight from Moscow eight days later, arriving back at the launch range via Tashkent.

Originally, there was a pool of ten dogs to choose for the flight, all of them trained at the Air Force's Institute of Aviation Medicine for previous upper atmospheric vertical flights. From a final three of Albina, Layka, and Mukha, biomedicine specialist Academician Vasilii V. Parin selected Layka ("barker") to have the honor of being the first living being to reach orbit. The choice was primarily based on the dog's even temperament. Air Force doctor Vladimir I. Yazdovskiy recalls:

Layka was a wonderful dog. . . . quiet and very placid. Before the flight to the cosmodrome I once brought her home and showed her to the children. They played with her. I wanted to do something nice for the dog. She had only a very short time to live, you see.⁶

Albina, with two prior flight experiences, was named Layka's "double" for the mission. A group of six physicians, headed by Oleg G. Gazenko, assisted in an intensive training program for the three dogs in the days preceding the scheduled launch. Before flying to the launch site, Yazdovskiy and Cazenko operated on the two dogs. They attached wires connected to sensors to monitor respiration frequency over their ribs and under their skins. A portion of the carotid artery was also diverted into a piece of skin to record pulse and blood pressure.⁷ Layka was put in the satellite container at mid-day on October 31, and by nighttime, the payload had been attached to the booster rocket. 8K71FS number MI-2PS. Temperatures at Tyura-Tam were very cold at the time, and the container was heated via a special hose attached to an air conditioner during the preparations for launch. Yazdovskiy, the *de facto* head of all biomedical operations, asked two of his assistants to keep a constant watch on Layka through the stacking procedures.

5 Yu Biryukov "From the History of Space Science: The Price of Decision—First Place (The First Satellites)" (English title) *Aviatsiya i kosmonavtika* no. 10 (October 1991) 37–39. Vasilii Mishin and Boris Raushenbakh "The Scientific Legacy of Sergei Korolev" in *History of the USSR: New Research 5: Yuri Gagarin: To Mark the 25th Anniversary of the First Manned Space Flight* (Moscow: Institute of the History of Natural Science and Technology, USSR Academy of Sciences, 1986) pp. 117–18. Mozhgorin *et al.*, eds. *Nachalo kosmicheskoy ery* p. 82. Colovanov Koroleu pp. 547–48. C. S. Vetrov "On the Launch of the Second Artificial Satellite of the Earth" (English title) *Nouostr kosmonavtiki* 23 (November 3–16, 1997) 50–54.

6 Colovanov Koroleu p. 550.

7 The six physicians were I. S. Balakhovskiy (O. C. Cazenko (physiology), A. M. Genin (hygiene), A. A. Gyurdzhyan (radiation), N. N. Kozakova, and A. D. Seryapin. Also involved in general preparations were Ye. M. Yuganov (vestibular apparatus) and A. R. Kotovskaya (overloads). See *ibid.* Aleksandr Romanov Koroleu (Moscow: Molodaya gvardiya, 1996) p. 306.

The 8K71FS booster lifted off on time at 0530 hours, 42 seconds Moscow Time on November 3, 1957, from the pad at site 1 at Tyura-Tam.⁸ Although the dog's pulse tripled during the launch phase, all vital signs were normal. The PS-2 spacecraft, named the "Second Artificial Satellite" in the Soviet press, successfully entered a 225- by 1,671-kilometer orbit with an inclination of 65.3 degrees to the equator. The satellite payload remained attached to the central block of the R-7 vehicle throughout its orbital flight. Total mass in orbit was about six and a half tons, approximately one-thirteenth of which was the actual payload. Doctors monitoring Layka in the following days began to notice a significant rise in the internal temperature of the biological compartment, apparently a result of inefficiencies and malfunctions in the spacecraft's thermal control system. For almost the entire period of her flight, Layka suffered a modicum of discomfort because of these high temperatures. The poor dog finally succumbed to heat exhaustion on the fourth day of the mission on November 7. Later analysis on the ground based on incoming telemetry confirmed the suspicions of doctors that overheating had in fact caused her death."

The Soviets revealed one striking piece of information unrelated to Layka many years later.

The scientific instruments on the PS-2 had performed without any problems for a week and had detected evidence for the existence of a radiation belt around Earth. Soviet scientists on the ground who studied the data were, however, "circumspect in their interpretations" of the information." In the end, the first U.S. satellite, Explorer 1, returned the same data a few months later, and the United States claimed one of the great discoveries of the early space age, the existence of a continuous band of radiation belts around Earth. The PS-2 spacecraft finally decayed from orbit on April 14, 1958, with its deceased passenger, having contributed to another long line of "firsts" in the Soviet space program.



Sputnik 2 is shown with its unique payload shroud at the launch pad at Tyura Tam in November 1957. Warm air was piped into the capsule to keep the dog Layka comfortable amid the freezing temperatures (files of Peter Gorin)

⁸ Council of Veterans of the Baykonur Cosmodrome *Proryv v kosmos* (Moscow TOO "Veles" 1994) p. 176. Another source states that the launch was at 0722 hours Moscow Time. See Yu. P. Semenov, ed., *Raketno-Kosmicheskaya Korporatsiya "Energiya" menit S. P. Koroleva* (Korolev RKK Energiya named after S. P. Korolev 1996) p. 92.

⁹ Yu. A. Mozzhorin et al., eds., *Dorog v kosmos I* (Moscow MAI 1992) p. 60. Golovanov, Korolev p. 551. Some reports have suggested that the temperature rise was a result of the nonseparation of the central R-7 sustainer from the payload. See Biryukov, "From the History of Space Science," K. V. Gerchik, ed., *Nezabyvayemyy Baykonur* (Moscow Interregional Council of Veterans of the Baykonur Cosmodrome 1998) p. 114.

¹⁰ Biryukov, "From the History of Space Science."

As the PS-2 was finding its way into the atmosphere, the engineers at OKB-1 were finally completing preparations to launch Object D, which had originally been slated to be the first Soviet satellite. Having been usurped from its place by the smaller PS-1 and PS-2 spacecraft. Object D was the last Soviet space project in existence at the time. The fact that government permission to allow work on Object D was not an endorsement for further space projects had become all too apparent by early 1958. There was, of course, little suspicion or knowledge in the West that all the Sputnik launches were either one-off efforts or hastily put-together projects resulting from the suggestions of a few anonymous men. In fact, the breadth and number of scientific instruments on board the spacecraft was literally a jolt to Western scientists. The 1.327-kilogram observatory made out of aluminum alloy was the first Soviet spacecraft to carry a "command radio-link" device for the control of instrumentation in orbit. There were twelve scientific experiments on board for the measurement and detection of:

- Primary cosmic radiation intensity
- The nuclei of heavy elements in cosmic rays
- Micrometeorites
- Atmospheric pressure
- Ion composition in the atmosphere
- The concentration of positive ions
- The magnitude of electric charges
- The intensity of electrostatic and magnetic fields
- The intensity of corpuscular solar radiation

The Tral multichannel telemetry system included a data recorder to store measurements out of the zone of communications visibility. Power was supplied by the first solar batteries used on a spacecraft, while internal temperature was controlled via circulating gaseous nitrogen. The useful payload of the sophisticated scientific observatory was 968 kilograms, and its scientific program was supported by a team of scientists from various disciplines, many of whom had been involved in mission planning since the project was approved in early 1956.¹¹

Object D was launched by a modified R-7 ICBM named the 8A91 on April 27, 1958. The launch vehicle, however, broke up into pieces during the active portion of the trajectory at T+96.5 seconds because of resonant frequencies, thus destroying two and a half years' worth of labor." Luckily for the scientists, OKB-1 had constructed an identical backup article with the same instrument complement. This craft was rumored to have been the subject of some political maneuvering prior to launch. There was reportedly some doubt about the functioning capabilities of the Tral-D data recorder built by the Experimental Design Bureau of the Moscow Power Institute. Korolev, under pressure from Khrushchev to launch the satellite in time to show support for the Italian Communist Party in the Italian elections, may have taken a gamble and opted to launch without verifying the operation of the device in question."

11. Mishin and Raushenbakh. "The Scientific Legacy of Sergei Korolev." pp 120-21: S L Nikolayev. "On the Work of M. K. Tikhonravov on the Creation of the First ISZ" (English title), *Iz istorii aviatsii i kosmonavтики* 42 (1980) 51-61. The primary Investigators included Sh. Sh. Dolginov, K. I. Gringauz, V. G. Istomin, V. I. Krassovskiy, L. V. Kurnosova, V. G. Kurt, Yu. I. Logachev, S. L. Mandelshcham, I. S. Shlovskiy, and S. N. Vernov.

12. Mozzhorin, et al., eds., *Nachalo kosmicheskoy ery*, p. 65: Biryukov, "From the History of Space Science." One source says that the failure occurred at T+88 seconds. See Timothy Varfolomeyev. "Soviet Rocketry that Conquered Space. Part I: From First ICBM to Sputnik Launcher." *Spaceflight* 37 (August 1995): 260-63.

13. Roald Z. Sagdeev, *The Making of a Soviet Scientist: My Adventures in Nuclear Fusion and Space From Stalin to Star Wars* (New York: John Wiley & Sons, 1994). pp. 156-58

The launch of the second Object D took place successfully on May 15, 1958, by means of another 8A91 booster. The spacecraft entered an Initial orbit of 1.881 by 226 kilometers at 65.2 degrees inclination. The Soviet press referred to the spacecraft as the "Third Artificial Satellite," later retroactively naming it "Sputnik 3." During its mission, ground controllers discovered that the data recorder did indeed fail, thus depriving scientists of information during periods when the satellite was not within communications view of ground stations. This had a repercussive effect on preventing scientists from confirming without doubt the existence of a radiation belt around Earth; there was simply no way to prove that the belt was continuous because of gaps in data. Despite the serious failure, there were 100,000 telemetric measurements and 40,000 optical observations conducted until communication was lost with the spacecraft on June 3, 1958. The mission provided a substantial amount of scientific and technological data in various disciplines." Object D finally decayed from orbit on April 6, 1960, leaving behind the record of having been the first advanced scientific observatory launched into space.

The launch of these three satellites, although isolated from any macro-level space program, helped in many ways cement the important roles of the chief designers in the Soviet defense industry. Although all Soviet press reports touted the achievements of the Sputniks as those of the Communist Party of the Soviet Union, it was increasingly clear within the leadership that the efforts of these designers also served an important propaganda and public relations role for the Soviet state. All of the major chief designers benefited from this state of affairs, both in a tangible and intangible sense. Korolev and Glushko, the two most powerful Chief Designers, had the distinction of being the only ones labeled criminals of the state in their younger years. The fall of Beriya in 1953 and the subsequent denunciations by Khrushchev of Stalin's ruthless rule eventually set the stage for the formal "rehabilitation" for both. Glushko's original accusations had been corrected in October 1956, but it took much longer for Korolev, who had suffered much more. He had applied to the Soviet government in a letter dated May 30, 1955, to drop the five remaining criminal charges that still marred his record." It would be the summer of 1957 before he would receive a reply from the USSR Chief Military Procurator. The letter merely stated that at a meeting of the Military Collegium of the USSR Supreme Court on April 18, 1957, the charges against him had been formally dropped. "due to the lack of any crimes."¹⁶ While Korolev tried to put the dark chapters in his life behind, Glushko was not as amenable. One of their associates later recalled:

... Korolev had convinced himself that one should forget about *Kolyma* prison, and all the rest, blot it out from memory and from the heart. Glushko [on the other hand] always remembered everyone and everything. He had saved many interesting documents. . . .¹⁷

Korolev was bestowed with a doctor of technical sciences degree, the Soviet equivalent of a Ph.D., on June 29, 1957, even though he had not defended a dissertation.¹⁸ Essentially an honorary title, it seems that Korolev did not use the title much in his writings. On December 18 of the same year, as a result of the huge successes of the first two Sputniks, he along with

14 *Ibid* p 158 Christian Lardier *L'Astronautique Soviétique* (Paris Armand Colin 1992) p 113 For a summary of the results from Sputnik 3 see Nikolayev "On the Work of M. K. Tikhonravov"

15 This letter is reproduced in full in N. L. Anisimov and V. G. Oppokkov "Incident at NII 3" (English title) *Voyenno istoricheskiy zhurnal* no 11 (November 1989) 65-71

16 Romanov Korolev pp 269-70

17 Col M. Rebrov "Specific Impulse" (English title) *Krasnaya zvezda* August 26 1989 p 4

18 Yu. V. Biryukov "Materials from the Biographical Chronicles of Sergey Pavlovich Korolev" (English title) in B. V. Raushenbakh ed *Iz istorii sovetskoy kosmonavtiki* (Moscow Nauka 1983) p 238 He was officially awarded the degree by the "High Certification Commission" on October 26 1957 just twenty two days after the launch of the first Sputnik

several others, such as Chief Designers Barmin, Glushko, Kuznetsov, Pilyugin, and Ryazanskiy, Deputy Chief Designer Mishin, and Academician Keldysh, were named recipients of the Lenin Prize. Three of Korolev's key deputies—Bushuyev, Okhapkin, and Voskresenskiy—were bestowed the more prestigious Hero of Socialist Labor for their efforts." Perhaps the most coveted of all honors came to Korolev and Glushko on June 20, 1958, when both were elected full Academicians of the USSR Academy of Sciences and thus befit of the highest level of stature in the scientific community. In truth, neither was a real scientist, and the promotion clearly would not have been approved by the Soviet scientific community had it not been for the recent successes in space. There were in fact many within the Academy of Sciences who privately scoffed at the promotions, bemoaning the influence of selective standards and political expediency. Along with Korolev and Glushko, the remaining four from the Council of Chief Designers—Barmin, Kuznetsov, Pilyugin, and Ryazanskiy—were promoted to Corresponding Members. Korolev's First Deputy Mishin also joined their ranks, an indication of the remarkable faith and trust Korolev had in his right-hand man. Mishin was the only deputy bestowed this honor.

The entry of the chief designers into the Academy of Sciences was extremely significant for the emerging space program because it provided a formal institutional setting from which to propose space projects outside of the conventional conduit of the defense industry." It also allowed the slow but visible separation of the space program from the missile program, although in 1958 this division was admittedly somewhat indistinct given the lack of a plan for space exploration. Academician Keldysh, with connections to both the scientific community and the defense industry, was an indispensable ally to the space designers. A consummate scientist and mathematician of great repute, Keldysh, in some respects, legitimized the dreams and proposals of space exploration in the eyes of skeptical Academy of Sciences leaders. Furthermore, Keldysh had far more influence with government and the Communist Party than any of the major designers, including Korolev and Glushko. Almost all of Keldysh's work in the 1950s had been in support of defense projects, and even the military depended, to a great extent, on the talented mathematicians and scientists in his employ at both the Department of Applied Mathematics and NII-1.

There were also institutional changes in the Soviet government and Communist Party that entrenched the position of the chief designers. By 1957, after the so-called "Anti-Party Group Affair," the locus of power in the Soviet leadership shifted from the government to the Party. Those duties originally administered by the old Special Committee No. 2 in the 1940s eventually ended up in the Secretariat of the Central Committee of the Communist Party. Leonid I. Brezhnev, a forty-four-year-old apparatchik from Dnepropetrovsk in the Ukraine was appointed a member of the Secretariat as a new Secretary of the Central Committee in June 1957, having served the Party in senior positions in Kazakhstan. Roughly analogous to the Western concept of a cabinet, the Secretariat itself was typically composed of about a dozen individuals with specific responsibilities overseeing almost every area of activity on behalf of the Party.¹⁹ The members of the Secretariat provided the all-powerful Presidium (later the Politburo) with analysis and recommendations. In many cases, the recommendations of the Secretariat member in

19. *Ibid.*, p. 239. The actual awards ceremony took place at the Kremlin on December 30, 1957. See Romanov, *Korolev*, pp. 307–08; Colovanov, *Korolev*, p. 551. Note that Korolev, the other chief designers, Mishin, and Keldysh had already been awarded the Hero of Socialist Labor in 1956 for the R-5M nuclear program. According to Mishin, Korolev had requested that he [Mishin] receive a second Hero of Socialist Labor in December 1957, but was refused only at the "highest level." See Mozzhorin, *et al.*, eds., *Dorogi v kosmos 1*, pp.

20. William P. Barry, "The Missile Design Bureaux and Soviet Piloted Space Policy, 1953–1974," draft of University of Oxford Ph.D. diss., 1995.

21. *Ibid.*, Peter Almquist, *Red forge. Soviet Military Industry Since 1965* (New York: Columbia University Press, 1990), p. 20.

question were often pivotal in the final decision by the Presidium. After 1957, Brezhnev's portfolio in the Secretariat included "questions of the development of heavy industry and construction, the development and production of modern military technology and weapons, the equipment of the Armed Forces with them, and the development of cosmonautics" for the Central Committee and the Presidium." This new role carved out in 1957 remained in existence throughout the next thirty years, and the holder of this post essentially acted as the *de facto* policy head of the Soviet space program. Curiously, it seems that Brezhnev, the first appointee to this post, did not have a very prominent role in determining space policy because the most important decisions were made by Khrushchev himself. What was significant, however, was that both Khrushchev and Brezhnev were very strong supporters of the missile industry, and Khrushchev in particular had been dazzled by the early successes of the Sputniks, thus treating a direct line from Korolev to Khrushchev on matters of future policy.

As power shifted into the Party apparatus, some of the most important supporters of the missile chief designers gravitated to higher positions in the defense industry, thus cementing support for the new space program. In particular, the first to benefit from the changes was Dmitriy F. Ustinov, Korolev's old "patron" from the 1940s. In December 1957, Khrushchev reorganized the Special Committee for Armaments of the Army and Navy, which had overseen the ballistic missile program since 1955, and created the new Military-Industrial Commission (VPK) to manage the *entire* Soviet defense industry; he put Ustinov in charge of the new governmental body. Staffed by the primary group of ministers in charge of the defense industry. VPK, after negotiation with the Soviet armed forces, managed the entire process of military procurement from research and development to production. On paper, its authority was limited to implementation, but because employees of VPK were responsible for drafting Party Central Committee decrees, the commission's jurisdiction extended to policy formulation.²² Ustinov, in turn, made sure that the most important positions within the defense industry were occupied by individuals who owed their careers to him. In March 1958, Konstantin N. Rudnev became the new Chairman of the State Committee for Defense Technology, the "new" ministry overseeing the ballistic missile and space effort. Essentially, the old Ministry of Defense industries with a new name, the State Committee had been created in January 1958 as part of a larger nationwide reform spurred by Khrushchev's goal to decentralize the Soviet economy. He set up a command system whereby "regional economic councils" (known in Russian as *Sovnarkhozes*) were established in key industrial cities such as Moscow, Leningrad, Corky, and Sverdolsk.²⁴ Research and development institutions in the former Ministry of Defense Industry, such as NII-88 and OKB-I, were transferred at the time to the newly created State Committee.

22 Arthur J. Alexander "Decision Making in Soviet Weapons Procurement" Adelphi Paper 14718 (Winter 1978/19) 1-64 For a detailed discussion of the role of the Secretariat in the defense and space industry see pp 11-12 in the same source

23 V. Pappo, Korystin, V. Platonov and V. Pashchenko *Dneprovskiy raketno kosmicheskii tsentr* (Dnepropetrovsk PO YuMZ/KBYu 1994) p 61 CIA Directorate of Intelligence *The Soviet Weapons Industry An Overview* DI 86 10016 (Arlington VA Central Intelligence Agency 1986) p 14 VPK members in March 1958 included the following 'ministers': K. N. Rudnev (Defense Technology), P. V. Dementyev (Aviation Technology), V. D. Kalmykov (Radio Technical Industry) and B. Ye. Butoma (Ship Building). In addition V. M. Ryabikov (Deputy Chairman RSFSR Council of Ministers) and M. I. Nedelin (Deputy Minister of Defense for Reactive Armaments) were also members. The commission had one First Deputy Chairman (S. I. Vetoshkin) and two Deputy Chairmen (C. N. Pashkov and C. A. Titov). Finally A. N. Shchukin, a respected radar expert, headed a "Scientific Technical Council" which, among other things, approved new members of the commission.

24 John McDonnell "The Soviet Defense Industry as a Pressure Group" in Michael McGwire, Ken Booth and John McDonnell eds. *Soviet Naval Policy: Objectives and Constraints* (Halifax NS: Centre for Foreign Policy Studies 1975) p 90 Alexander C. Korol *Soviet Research and Development: Its Organization, Personnel and Funds* (Cambridge MA: The MIT Press 1965) p 17

The entire decentralization process had a repercussive effect of putting a greater share of the power over missile and space design and production into the hands of a new generation of bureaucrats, nurtured by Brezhnev and Ustinov, who were not located in Moscow.²⁵ The forty-seven-year-old Rudnev himself had served as director of NII-88 in the early 1950s and could be counted on to lend his support to Ustinov and Korolev at critical decision-making junctures. He was personally acquainted with all designers such as Korolev and Glushko and had also been a member of the State Commission for the R-7 launches. In his new position as the Chairman of the State Committee for Defense Technology, he was to play a much more "hands-on" role in the new space program, exceeding that of his predecessors. He was, in effect, the first industrial manager of the Soviet space program, akin to perhaps the role played by NASA administrators. By most recollections, he was very educated, accomplished, and sophisticated, although little is known about his personal life. An associate later described him as:

*Unpretentious in his manner and attentive to people, he listened with enviable patience to the opinions of opponents without putting them into a rigid provisional framework. In a difficult moment . . . he managed to relieve the tension with a joke and he was witty, but short-spoken.*²⁶

On paper at least, Korolev reported through the Chairman of the State Committee for Defense Technology (Rudnev), to the Chairman of the Military-Industrial Commission (Ustinov), to the Secretariat member in charge of defense industrial matters (Brezhnev), and finally to Soviet leader Khrushchev himself. By all accounts, this chain of command, especially in the case of new proposals, was merely a formality and rarely functioned as intended. Following the first launches of the R-7 and the Sputniks, Khrushchev regularly consulted with Korolev himself. The Council of Chief Designers seems not only to have exerted influence over programs that had been approved by Khrushchev, but also began to have some input into program commencements and approval. In particular, the council would often pass resolutions that were binding, albeit unofficially, for all the design bureaus and scientific-research institutes



Konstantin Rudnev was Chairman of the State Committee for Defense Technology between 1958 and 1961. In that post, he effectively served as the first administrator of the emerging Soviet space program. He had served his apprenticeship in the early 1950s as Director of the famous NII-88 institute (files of Peter Gorin)

25. McDonnell, "The Soviet Defense Industry as a Pressure Croup," p. 116. One of those was an individual named S. A. Afanasyev, who was appointed to head the Leningrad Sounarkhoz in May 1958, having served his apprenticeship as a directorate chief in Ustinov's ministry in the 1950s. Afanasyev's career would rise with Ustinov's, and he was to play an important role in the space program in the years to come.

26. Lt. Gen. Georgiy Aleksandrovich Tyulin, "Task for the Future: Notes of the State Commission Chairman" (English title). *Krasnaya zvezda*, April 2, 1988, p. 4.

involved. But in the end, it was always a question of Khrushchev's general assent or dissent. While Ustinov or Rudnev could hammer out the details. Khrushchev had the last word.

Fortunately for Korolev, the Soviet leader was clearly enamored of Korolev from 1956 through 1958. The remarkable support Khrushchev extended to Korolev at the time depended to a great extent on his achievements in building and successfully launching the R-7 ICBM. But the origins of the Khrushchev-Korolev relationship date back to February 1956 during Khrushchev's first visit to OKB-1 at Kaliningrad. As Khrushchev's son, one of those who accompanied the elder Khrushchev on that visit, later recalled, "The meeting with Korolev decisively influenced the thinking of my father. . . . After this visit father simply fell in love with Korolev, he was prepared to talk about him without end." "There were special perks to this change of heart, most notably demonstrated by allowing Korolev to call Khrushchev directly on matters, without having to go through "numerous bureaucratic obstacles." "

While the propaganda-type effects of Sputnik were clearly a boon to the Soviet leadership, the first and foremost goal on the Presidium's agenda was the achievement of strategic parity. Korolev had used the R-7 as a "Trojan horse" for his more outlandish dreams of space exploration, but he was also clever enough to know that the gains from the creation of the R-7 would not be unlimited. The next few years had Korolev toeing the fine line between appeasing those who wanted newer and better ICBMs and those who wanted the world to shudder in the face of Soviet accomplishments in space. In this sense, 1958 was a watershed year for Korolev and his associates on the Council of Chief Designers. The forces of institutions, politics, and personalities were in place for them to gradually create a new space program out of pieces of the missile program. The Object D, PS-1, and PS-2 projects had been short-lived, one-off programs intended to take advantage of the availability of the new R-7 ICBM to gain a foothold into space. It was now time to create a plan and a vision of a comprehensive program designed to put the Red Star firmly into space.

"I Favor Orbital Flight!"

Two themes stand out in all the proposals for artificial satellites sent to the government in the 1950s by Korolev and Tikhonravov: automated missions to the Moon and piloted flight into space. At every juncture, both engineers foresaw the two complementary projects as fundamental to the initial growth of the Soviet space program. Early Soviet conceptions for piloted spaceflight dated back to 1945-48, to Tikhonravov's short-lived VR-190 project for launching a human on a vertical flight to the upper reaches of the atmosphere. Later, when Korolev tasked doctors at the Air Force's Institute of Aviation Medicine in 1949 to develop systems to launch dogs into space, he viewed the effort only as a step to achieving the ultimate goal of human spaceflight." The first vertical launches with animals in 1951 on the R-1B and R-1V rockets were thus not isolated projects for OKB-1, but rather the first concrete step in a larger thematic direction of piloted space exploration. These biological flights were followed from 1954 to 1956 by launches on the updated R-1D and R-1E "scientific" missiles, further variants of the basic military R-1 rocket.

The flight profile that engineers developed for the R-1D launches was considerably different from that of the R-1B, and it clearly indicated a progression toward human as opposed to biological spaceflight. The rocket was launched to altitudes of 100 to 110 kilometers, at which

27 Sergey Khrushchev *Nikita Khrushchev krizisy i rakety vzglyad iznutri tom 1* (Moscow Novosti 1994) p 112

28 *Ibid* p 104

29 As early as 1951 OKB-1 may have drawn up preliminary plans for a small capsule to carry a person on a high altitude vertical flight using the R-1B missile which itself was used for the early dog launches. For a drawing of one of these conceptions of the R-1B see Lardier *L'Astronautique Soviétique* p 244

point the dog cabin separated, going into a free-fall unstabilized trajectory. The dog seated on the right of the cabin ejected at altitudes of seventy-eight to eighty-four kilometers and used a parachute for landing during the following six minutes. The second dog was ejected at altitudes of thirty-nine to forty-five kilometers. Unlike the earlier flights, engineers dispensed with a pressurized cabin for the dogs and instead equipped each animal with its own life-support system in the form of a spacesuit. The aviation Plant No. 918 at Tomilino developed a mask-free suit, which included the suit itself, a detachable plexiglass helmet, an oxygen supply system, and a retractable tray on top of an ejection trolley. The last item carried the oxygen supply, the parachute system, and the physiological measurement equipment. Like the previous launches, a movie camera with a five- to six-minute supply of film recorded the dogs' reactions during various parts of the flight.³⁰ The total mass of the payload was 1516 kilograms. In addition to the dog container, the R-ID carried two 130-kilogram scientific experiments packages from the Geophysical Institute of the USSR Academy of Sciences (GeoFIAN).³¹ A group of twelve dogs, including flight veterans Albina, Malyshka, Kozyavka, and Tsyganka, was assembled to train for the launches, undergoing rigorous simulations with spacesuits in the cramped cabin.

The first R-ID missile lifted off on July 2, 1954, from Kapustin Yar with dogs Lisa and Ryzhik on board." As planned, the first dog ejected out at an altitude of ninety kilometers, while the second was cast off at forty-five kilometers. Only two further launches were conducted in the series, in July 1954, and although none of the launches were completely successful, the engineers and physicians moved ahead with the use of another "new" missile, the R-1Ye. The latter was distinguished from its predecessor by the addition of a heavier complement of scientific experiments, including two 130-kilogram ejectable GeoFIAN strap-on containers. One of these, the DK-2, included five smoke candles whose ignition mechanism operated at various altitudes to measure wind direction. Unlike the R-ID, the R-1Ye main rocket body was also equipped with a system for allowing the recovery of the entire 4,286-kilogram frame. Four huge parachutes would reduce the rate of descent from 635 meters per second to a bearable seven meters per second." The container for the dogs and the return profile remained exactly the same from the R-ID variant. The R-1Ye series was inaugurated with an early morning launch on January 25, 1955, carrying the dogs Albina and Tsyganka." Engineers carried out

30 Yu A Mozzhorin et al eds *Dorogi v kosmos II* (Moscow MAI 1992) pp 130-32 137 M V Keldysh ed *Tvorcheskoye naslediyе Akademika Sergeya Pavlovicha Koroleva izbrannyye trudy i dokumenty* (Moscow Nauka 1980) p 351 George E Wukelic ed *Handbook of Soviet Space Science Research* (New York Gordon and Breach Science Publishers 1968) pp 18-19 The ejection system for the dog container was developed by N M Rudniy over a period of three years beginning in January 1951

31 The primary scientific goals of these second series of vertical launches were (1) research into the physical and chemical characteristics of air measurement of the aerodynamic characteristics at high velocities and altitudes and development of methods of determining the direction and velocity of the wind in the upper layers of the atmosphere (2) determination of the physical processes in the ionosphere and the density of ionization at altitudes of 100 kilometers and research into altitudes of the D ionization layer and the distribution of voltage at the poles and (3) research into the life activities of animals associated with the lifting of rockets to great altitudes and testing of systems for the rescue of the animals and a system of rescue of a payload with instruments. In addition the R-ID rocket was said to be equipped with the STK apparatus and telemasurement sensors for a special development program. See Keldysh ed *Tvorcheskoye naslediyе Akademika* p 542

32 Biryukov *Materials from the Biographical Chronicles* ' p 233 Lardier *L'Astronautique Soviétique* p 81 Mozzhorin et al eds *Dorogi v kosmos II* pp 135-36

33 Peter Stache *Soviet Rockets Foreign Technology Division Translation FTD ID(RS)T 0619 88* (from unnamed source) Wright Patterson Air Force Base Dayton Ohio November 29 1988 p 2 19 This is a translation of Peter Stache *Sowjetischer Raketen* (Berlin Militärverlag der DDR 1987) See also Keldysh ed *Tvorcheskoye naslediyе Akademika* p 538

34 Biryukov *Materials from the Biographical Chronicles* ' p 234 Evgeny Riabchikov *Russians in Space* (Moscow Novosti Press Publishing House 1971) pp 141-42

at least five more launches with dogs by June 1956, confirming the selection of the basic design elements of the systems for ensuring the life support and rescue of the dogs.

The physicians involved in the program found that the test animals suffered no major changes in breathing and in their pulmonary and circulatory systems during the various phases of the flight. The failures in the R-1B program were apparently all associated with the rescue of the main body; all attempts to recover the rocket body failed because of the failures of the parachutes to withstand the shock of deployment." Korolev, who summarized the results of the total of fifteen biological launches from 1951 to 1955. at a Moscow conference in April 1956. recalled that the series yielded "valuable, positive results" despite three major failures. He added. "The rockets met the numerous, highly complex, often vaguely formulated requirements constantly levied by our colleagues."³⁶

The results from the R-1B, R-1D, and R-1E biological series of rockets were precisely what Korolev needed to move ahead with plans for human spaceflight. If the launch of an artificial satellite was his first overriding goal, then the launch of a human into space was without doubt the second important step to what he saw as fulfilling Tsiolkovskiy's original dreams of space exploration. It was during the R-1D launches with dogs in 1954 that the Soviet government received its first request to engage in piloted spaceflight. Tikhonravov's landmark document on artificial satellites clearly detailed a plan for immediate vertical launches of humans to 100 to 200 kilometers on existing rockets. A year later, in his annual report to the Academy of Sciences dated June 25, 1955, Korolev wrote:

*[It is necessary to consider] the proposal to create a missile laboratory for the lifting of 1-2 researchers to altitudes of 100 kilometers and the development of a special system for the return of a laboratory with its crew to the Earth. The importance of such an experiment is huge not only from a scientific point of view, but also from the point of view of maintaining the USSR's priority in native missile technology. We know that if the necessary scientific and technological base for the accomplishment of the goal is created, in 1956 we will be able to start such flights. We ought not to forget that work in this direction is being carried out very intensively in the U.S.A.*³⁷

In April 1956, at the All-Union Conference on Rocket Research into the Upper Layers of the Atmosphere, held under the aegis of the Academy of Sciences, Korolev responded to criticisms of human spaceflight:

There is the question as to whether or not vertical launches of a manned rocket. . . have any practicality for research. . . the effects of stress upon the human organism during rocket flight would not be for too long and would not be excessive even if the effects of acceleration would vary in terms of intensity as well as the direction of effect during var-

35 Stache *Soviet Rockets* p 219

36 A portion of the text of Korolev's speech has been published as S P Korolev "Research into the Upper Layers of the Atmosphere With the Aid of Long-Range Missiles" (English title), in Keldysh, ed. *Tvorcheskoye naslediyе Akademtka* pp 348-61. One failure was related to a malfunction in the power supply to the launch facility during a launch while a second was caused by "a break in connection" that resulted in the "measuring head" separating prematurely during the ascent phase of the rocket. See the same source p 354. Of the three failures two were in the R-1E series and one was in the R-1B series.

37 The complete text of Korolev's report to the Academy of Sciences has been published as S P Korolev "Account of Scientific Activities in 1954" (English title) in Keldysh, ed. *Tvorcheskoye naslediyе Akademika* pp 344-46.

ious phases of the flight. This would, of course, still be very unpleasant. Still, it can now be said with some certainty that overstress will not stand in the way of manned rocket flight. . . We feel that today prevailing difficulties can be overcome and manned rocket flight implemented. This will mean an immense expansion of research possibilities, aside from the pure significance of such flights."

Few in the audience were aware that OKB-1 had already begun actual design work on a piloted spaceship using scientific versions of the R-1 and R-2 missiles.

At a restricted session of the 125th anniversary of the N. E. Bauman Moscow Higher Technical School, in September 1955, Korolev had presented his conceptions for vertical piloted spaceflight. He was remarkably forthright about his intentions:

Our mission is to ensure that Soviet rockets fly higher and farther than has been accomplished anywhere else up until now. Our mission is to ensure that a Soviet man be the first to fly in a rocket. And our mission is to ensure that it is Soviet rockets and Soviet spaceships that are the first to master the limitless space of the cosmos."

The initial exploratory work on the project was carried out between April 1955 and May 1956 at OKB-1 under the technical leadership of engineer Nikolay P. Belov. Parallel work on the theme was also undertaken by Tikhonravov at NII-4. At a meeting in early 1956 to discuss the continuing vertical launches of dogs into space, Korolev proposed that dedicated work begin to replace dogs with humans. Enthusiastic to participate in this effort, a group of doctors at the Air Force's Institute of Aviation Medicine had sent formal requests to Vladimir I. Yazdovskiy, the department chief at the Institute of Space Medicine, to be considered as test subjects for the suborbital launches.³⁸ A small team, including Abram M. Genin, Ivan I. Kasyan, Aleksandr D. Seryapin, and Yevgeniy M. Yuganov, was established in March 1956, although it seems that they did little actual training for space missions.³⁹ Having been closely involved in the development of the flight instrumentation for the dog flights, these doctors were primarily engaged in the design of a capsule capable of carrying a human into space on a single-stage ballistic missile.

Belov's team at OKB-1 considered a common cabin design that would carry a pilot as the payload in a scientific variant of the military R-2 ballistic missile. The passenger would sit in a reclining seat surrounded by instruments and a camera to film the pilot's own reactions to flight conditions. Although a singular cabin design was considered, Belov's team studied at least five different methods of returning the capsule to Earth. The first variant used a parachute system triggered at a low altitude in much the same way as was used on the R-1B shots in 1951. Following separation from the main body of the rocket, the payload would deploy auxiliary air brakes as well as stabilizers to reduce deployment shock for the parachutes. Velocity would be reduced from 2,050 meters per second at the moment of separation from the rocket (forty kilometers) to 185 meters per second within forty-eight seconds and finally to just under one and a half meters per second at landing. Special thermal insulation would be developed for the air brakes. The second means of return used a reverse method. The point of separation from the

38. Korolev, "Research into the Upper Layers of the Atmosphere" pp. 359-61

39. Golovanov, Korolev, p. 598.

40. Yaroslav Golovanov, "Cosmonaut No. 1: Selection" (English title), *Izvestiya*, April 2, 1986; Mozhgorin, et al., eds., *Dorogi v kosmos II*, p. 143; Lardier, *L'Astronautique Soviétique*, p. 120; V. P. Mishin, "Problems of the First Flight of a Man into Space" (English title), in *Gagarinskiye nauchnyye chteniya po kosmonavtike i aviatsii* (Moscow, Nauka, 1991), p. 22

41. Lardier, *L'Astronautique Soviétique*, p. 121; Golovanov, Korolev, p. 598; Col. V. Corkov, "History of the Space Program Resident of Star Town" (English title), *Aviatsiya i kosmonavtika* no. 1 (January 1990): 20-23.

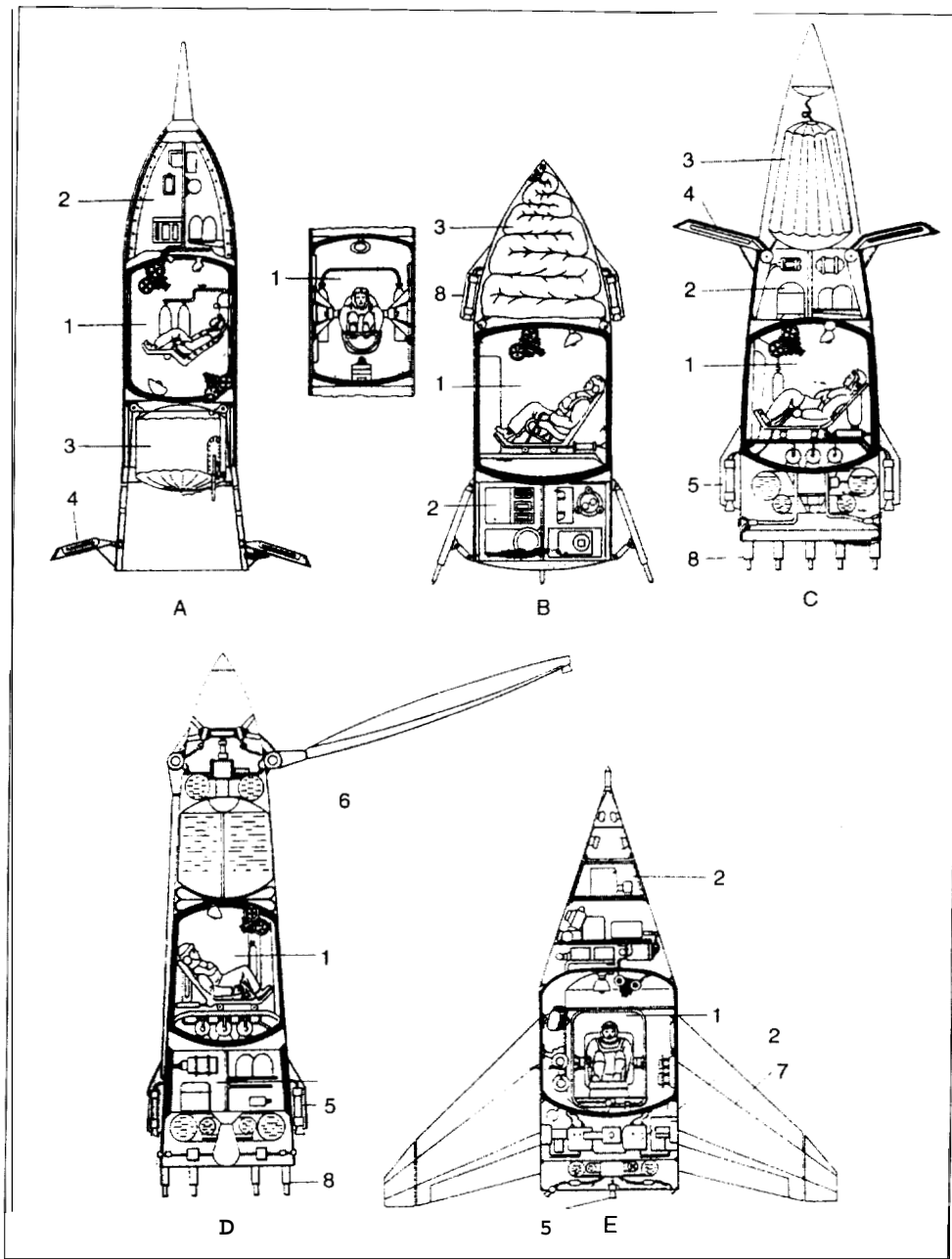

Beginning in 1955 OKB 1 studied five different types of spacecraft for sending a pilot on short hops into space on the R 2A missile. From top left to right are (A) capsule with return by parachute and air brakes, the latter also for stabilization; (B) capsule with return by parachute and solid propellant rocket engines; (C) capsule with return by parachute, stabilization by rocket engines and air brakes, and braking by air brakes and by rocket engines during terminal phase; (D) capsule equipped with helicopter type rotors with rocket engines on the blade ends, and (E) spacecraft with wings for gliding return with the aid of stabilization engines. Legend: (1) capsule, (2) equipment, (3) parachute system, (4) braking and stabilizing surfaces, (5) position stabilizing nozzles, (6) rotor, (7) wings, and (8) braking engine. (reproduced from Peter Stache, *Sowjetischer Raketen* (Berlin: Militärverlag der DDR, 1987))

CHALLENGE TO APOLLO

main rocket body would be at a much higher altitude, but at a much lower velocity—that is, similar to the R-1Ye biological rockets. Auxiliary brakes would further reduce the velocity of descent to prevent parachute failures. The third conception was different from anything yet built and used small rocket engines to ensure stable positioning during the descent portion. The capsule would also use improved and larger air brakes in the upper portion of the spacecraft, as well as special brakes to reduce the landing shock for the passenger. This was an idea taken from Tikhonravov's VR-190 piloted rocket project in the 1940s.

The fourth and fifth variants for landing the capsule were perhaps the most ambitious and innovative. For the fourth system, OKB-1 engineers completely dispensed with the problematic parachutes, replacing them with seven-meter-diameter helicopter rotors fixed on the nose cone of the capsule. At the peak of its trajectory, the rotors would deploy and start moving in a circular motion by means of small rocket engines fixed to the tips. Stabilization during the descent would be ensured by additional control nozzles on the capsule. Engines for soft-landing were also installed at the base of the return capsule. The rotor idea was a design to which Korolev himself returned many times in the next few years, refusing to abandon what he considered its elegance. While the first four variants of return were based on the premise of a directly vertical flight into the upper atmosphere up to 200 kilometers, the fifth envisioned a true ballistic flight downrange about 600 to 1,000 kilometers, but also with a ceiling of 200 kilometers. The primary reason for taking this approach was the increased time of weightlessness—about fifteen minutes for the passenger. Korolev believed that such a ballistic suborbital flight could be accomplished without any problems if the return capsule was equipped with large delta-shaped wings. Stabilization and position control engines as well as aerodynamic rudders would aid during the descent of the pilot. Such a design would also lay the basis for the development of a supersonic transport vehicle capable of flying at velocities of 3,500 to 7,000 kilometers per hour."

All of these various models would be launched on a *modification* of the R-2 missile, the scientific R-2A rocket. The old R-1 rocket, essentially a copy of the German A-4, had limited the range of investigations of the upper atmosphere to 100 kilometers. The introduction of the R-2 doubled this altitude, allowing the first investigations in what might be considered "true space." The draft plan for the R-2A rocket was completed in 1956 at OKB-1. The rocket, which was just under twenty meters long, would carry a payload weighing about 1,340 kilograms with two dogs as well as two 430-kilogram strap-on containers for scientific studies. The dog capsule itself had an internal volume of just under half a cubic meter and was in fact the prototype of the cabin used on the second Sputnik to carry Layka into orbit.⁴³ For the first time, accommodation was made for the ingestion of food by the animals during flight. This third generation of dog capsule dispensed with the catapult mechanism used in the previous series. Instead, the dogs, dressed in spacesuits, were strapped into separate chambers in a pressurized area in the nose cone. At the peak of the trajectory, the payload would separate and go into free fall. At five kilometers altitude, an improved recovery system with a series of three parachutes would deploy." The design and development of the R-2A biological missile were carried

42 The details of all five designs were included in Korolev's speech at the N. E. Bauman Moscow Higher Technical School in September 1955 and are summarized in Stache, *Soviet Rockets*, pp. 261–71

43 Lardier, *L'Astronautique Soviétique*, p. 82

44. Stache, *Soviet Rockets*, p. 222, The following overall scientific goals were listed in the draft plan of the R-2A (1) research into the chemical composition of air and measurement of air pressure at altitudes of 150–200 kilometers; (2) detection of solar ultraviolet radiation in the Lymanovskiy hydrogen series at 900–1,200 angstroms and photographing the surrounding areas; (3) research into the possibilities of survival and life support for animals lifted on the rockets to 200 kilometers; (4) testing of systems for rescuing the payload, and (5) determination of physical processes in the ionosphere and ionization density at altitudes of 150–200 kilometers. In addition, as in the R-1D program, the R-2A was said to be equipped with the STK apparatus and telemeasurement sensors for a special development program. See Keldysh, ed., *Tvorcheskoye naslediyе Akademika*, p. 546.

out in parallel with Korolev's studies on human rocket flight because both were to use the common R-2A rocket as a launch vehicle

The first R-2A was launched successfully on May 16, 1957, from Kapustin Yar the day after the first launch attempt of the R-7 ICBM. The two dogs on board, Ryzhaya and Damka, experienced a long six minutes of microgravity before returning safely to Earth after reaching an altitude of 212 kilometers. At least four more successful launches were carried out in the initial series, the last on September 9⁴⁵. It was less than two months later that the same container was used to carry Layka into Earth orbit. These R-2A launches laid the groundwork for the piloted hops into the atmosphere but by late 1957 it seems that Korolev had been looking for other options. One of the original reasons for immediately commencing a piloted vertical program was the belief that an orbital satellite with a human on board would only be possible as late as 1964-66⁴⁶. With the advent of the R-7 ICBM, these projections were drastically shortened by about five years. As Belov's group at OKB-1 continued work on crewed hops into the atmosphere, it was increasingly clear at least to Korolev, that the future lay elsewhere.

As with many of the new directions in the early Soviet space program, the most fruitful and groundbreaking work emerged from Tikhonravov's resourceful group, which had recently been transferred from NII-4 to OKB-1. On March 8, 1957, Korolev consolidated the work under Tikhonravov and established the new Department No. 9, comprised of about thirty young engineers. It was now the "planning department for development of space apparatus." That is, its focus was narrowed exclusively to space exploration—a significant event that in retrospect signaled the beginning of OKB-1's gravitron from creating missiles to designing spacecraft. In April, Tikhonravov facilitated some discussions among his team members about objectives on which they could focus. Three basic directions emerged:

- Continuing work on Object D, with expansion of work on a satellite capable of observation
- Initiating work on a biological satellite capable of carrying dogs in orbit for more than a day
- Developing a capsule for vertical flights of humans to altitudes of 300-400 kilometers

At the same time, Tikhonravov identified two future streams of work: the development of a piloted orbital spaceship and the creation of automated lunar exploration spacecraft.

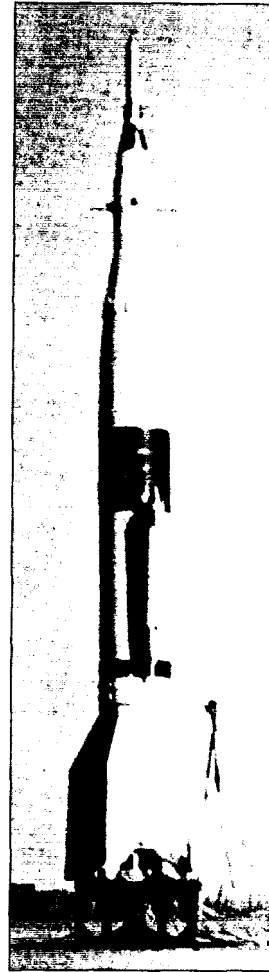

This is one of the R-2A missiles thirteen of which were launched between 1957 and 1960. Many of them carried biological containers with dogs to altitudes as high as 200 kilometers. A similar container was used to carry Layka into orbit on Sputnik 2. For a brief period, Korolev also planned to use the R-2A to launch humans on vertical hops into space (files of Asif Siddiqi)

⁴⁵ Biryukov, "Materials from the Biographical Chronicles," p. 238. Wukelic, ed., *Handbook of Soviet Space Science Research*, p. 10.

⁴⁶ A. Yu. Ishlinskiy, ed., *Akademičeskij S. P. Korolev: Učeničeskij inženier, čelovek* (Moscow: Nauka, 1986), p. 506.

Research on these topics had actually begun in November 1956, but it was consolidated in a document issued in April 1957, titled "A Project Research Plan for the Creation of Manned Satellites and Automatic Spacecraft for Lunar Exploration."⁴⁷ Still classified, the report laid the groundwork for the early piloted space programs in the Soviet Union.

This initial work in 1957 at OKB-1 helped limit the parameters of the future design of a piloted orbital spaceship. Engineers found that the mass of such a satellite could be as high as three to four tons and possibly five tons if the R-7 was augmented by an appropriate upper stage. They also made advances in methods for computing parameters of the heat stream on the surface of "a simple" body returning into the atmosphere at hypersonic velocities. Research between September 1957 and January 1958 was instrumental in narrowing down such factors as the mass of thermal protection and temperature ranges for various types of reentry bodies. Finally, scientists at Keldysh's Department of Applied Mathematics confirmed that with a ballistic reentry with zero lift, loads on a returning body would not exceed ten times the force of gravity.⁴⁸

Korolev and Tikhonravov may have been primarily interested in Tsiolkovskiy's ideal of space exploration, but OKB-1 was still an organization funded by the Ministry of Defense. Tikhonravov's early work on piloted orbital spacecraft was in fact closely tied to goals more in line with those formulated by the military, a point strongly reflected in Tikhonravov's early conception for a satellite capable of "observation." Using the basic Object D frame as a starting point, in late 1956, Tikhonravov had begun work on two new variants of the satellite. Objects OD-1 and the OD-2; the "OD" stood for "oriented D." The OD-1 was a prototype of a military reconnaissance satellite with a passive orientation system, while the OD-2 was the prototype of a biological version for dogs with an active orientation system.⁴⁹

It seems that the OD-1 reconnaissance satellite had the unofficial support of higher leaders, probably in the Ministry of Defense, although there was no formal approval for the work. Like most other early space projects, the momentum for the OD-1 came not from above but from below. Korolev and Keldysh had both signed a letter dated April 12, 1957, to the Council of Ministers on accelerating work on the OD-1. Later on July 2, Korolev apparently sent another letter to the government requesting approval to develop a photo-reconnaissance satellite using the OD-1 design.⁵⁰ Little information has been revealed on this early proposal. According to the design, the satellite was to use special recoverable film cassettes, which were designed by the Institute of Applied Geophysics of the Academy of Sciences. The S. I. Vavilov State Optical Institute, meanwhile, was tasked to develop the secret cameras for the spacecraft. The spacecraft itself consisted of two modules: a recoverable conical capsule carrying cameras and film and a large cylindrical instrumentation section with conical or spherical ends."

47 *Ibid.*, p. 447; B. V. Raushenbakh, ed., *Materialy po istorii kosmicheskogo korablya "Vostok"* (Moscow: Nauka, 1991), p. 210; S. S. Kostin, "Some Aspects of Planning the 'Vostok' Space Ship" (English title), *Iz istorii aviatsii i kosmonautiki* 42 (1980): 62-66; Timothy Varfolomeyev, "Soviet Rocketry that Conquered Space. Part 3. Lunar Launchings for Impact and Photography," *Spaceflight* 38 (June 1996): 206-08; Semenov, ed., *Raketno-Kosmicheskaya Korporatsiya*, p. 105.

48 Kostin, "Some Aspects of Planning the 'Vostok' Space Ship". Semenov, ed., *Raketno-Kosmicheskaya Korporatsiya*, p. 105.

49 Raushenbakh, ed., *Materialy po istorii*, p. 210.

50. The text of the first letter has been published as S. P. Korolev, "Proposal for an Oriented Satellite of the Earth" (English title), in Keldysh, ed., *Tuorcheskoye naslediyе Akademika*, pp. 373-74. See also Georgiy Stepanovich Vetrov, "The First Satellite: Historical Limits" (English title), *Novostr kosmonautiki* 16 (July 28-August 10, 1997): 2-9.

51. Yuriy Mikhaylovich Frumkin, "Without the 'Secret' Stamp: The First Reconnaissance Satellite" (English title), *Aviatsiya i kosmonautika* no. 3 (March 1993): 41-42; Yu. M. Frumkin, "Development of First Soviet Photoreconnaissance Satellite 'Zenit'" (English title), *Priroda* no. 4 (April 1993): 72-78.

The OD-2 biological variant apparently had less support, even among the engineering leaders within the space program. But it seems that research on this dog satellite had generated a modicum of discussion at various levels on the utility of human spaceflight. There were intensive discussions at the level of the Council of Chief Designers through 1958 on whether to even attempt human orbital spaceflight or whether to simply continue the more modest program aimed at vertical attempts. Some rejected ideas for piloted spaceflight based on concerns about the dangers of stress, weightlessness, meteors, reentry, and even cost. Others, including a number of chief designers on the council, believed that the optimal way would be to proceed at least initially with vertical hops to the upper atmosphere, as was being studied by Tikhonravov's team. A third faction within Korolev's OKB-1 proposed true suborbital launches with flights about 1,000 kilometers downrange, such as those studied by Belov's group, arguing that the experience from these modest launches would be adequate for the moment. Although it seems that Korolev had vigorously favored the latter two options during the mid-1950s, by 1958 his mood had become more ambitious and perhaps impatient.

Korolev's ideas were opposed by a number of major figures in the new space program during a meeting at the Academy of Sciences attended by representatives of various design bureaus, scientific-research institutes, the military, and the aviation medicine sector. Academician Norair M. Sisakyan, a leading biomedicine specialist who had been involved in the dogs-in-space program, cautioned about the publicity afforded to a potentially fatal attempt to orbit a pilot. Arkadiy S. Tomilin, the Chief of the Seventh Chief Directorate in the State Committee for Defense Technology, also opposed an orbital attempt, calling Korolev a "science fiction writer."⁵² Korolev did, however, have the key support of not only Keldysh and Glushko, but also Maj. General Aleksandr G. Mrykin, Marshal Nedelin's chief specialist on space and missile issues and a very powerful figure in the military. Throughout 1958, these kinds of discussions were apparently quite common, but Korolev's headstrong support for orbital flight slowly emerged as a winner. As in the tremendous steps in the early evolution of the ICBM program, he believed that what was needed at that point were not incremental advances, but a significant leap in capabilities. Referring to the more modest approaches advocated by some of his associates, he was reported to have said at one meeting:

These are approaches with no future. We need spacecraft for flights around the Earth. Although gradual visits to space are effective, they are of no significance for science and for spaceflight. I favor orbital flight —we can achieve our goal without intermediate stages!"

The Object K

On the morning of February 15, 1958, Korolev called Tikhonravov into his office and tasked him to begin formal work on a piloted orbital spaceship.⁵³ The vehicle would inherit the OD-2 designation originally kept for launching dogs into orbit. This project would continue in parallel with Belov's efforts to develop a suborbital piloted spacecraft. Tikhonravov appointed a talented thirty-two-year-old engineer in his department, Konstantin P. Feoktistov, to lead the engineering aspects of the effort. A protege of Tikhonravov's, at the age of ten, Feoktistov was already making plans for exploring the Moon. In 1942, as a sixteen-year-old scout for Soviet

⁵² Romanov *Korolev* pp 326-32. A. P. Romanov and V. S. Gubarev *Konstruktory* (Moscow: Politicheskoy literatury, 1989), pp. 312-17. Note that a completely garbled and censored account of this meeting was reproduced in A. Romanov *Spacecraft Designer* (Moscow: Novosti Press Agency Publishing House, 1976) pp. 38-42. Not only were the names disguised (Sisakyan becoming Stepanov and Tomilin becoming Koptev) but conversations were so twisted beyond recognition, that in some cases the same person was having a conversation with himself in some passages!

⁵³ Stache *Soviet Rockets* pp. 265-66.

⁵⁴ Romanov *Korolev* p. 311.

partisan units during the Nazi invasion of the Voronezh region, he had been captured, shot, and left for dead. By a stroke of incredible luck, he had only been injured by the gunfire and waited until dark to crawl away to safety. In later years, he graduated from the N. E. Bauman Higher Technical School before finding work under Tikhonravov at NII-4. As the Chief of the Group for Planning Piloted Space Apparatus, he oversaw twenty young engineers at OKB-I who began work in early 1958 on the design of a vehicle capable of carrying a human into orbit."

Feoktistov's group began in March–April 1958 by addressing the problem of safely returning a capsule from orbit. In 1953, Timur M. Eneyev at Keldysh's Department of Applied Mathematics had conducted some of the earliest research on ballistic reentries of orbital vehicles. Eneyev's landmark work was used, in combination with theoretical work done the same year by Keldysh, Georgiy I. Petrov, Vsevolod S. Avduyevskiy, and others at NII-1, on the thermal characteristics of various materials for heat protection. The material eventually selected for the new spaceship was reinforced plastic of asbestos fabric.⁵⁶ During calculations for the thickness of this layer, one of the engineers, Konstantin S. Shustin, had mistakenly erred by a factor of two. Fortunately for the spaceship, Korolev had earlier demanded that the required thickness be multiplied by a factor of four for total safety (to fifty millimeters).⁵⁷ Feoktistov's group chose a simple ballistic means of reentry with no lifting surfaces. Many different landing systems were examined during this process, including Korolev's favorite helicopter rotor system. Korolev contacted the noted Soviet helicopter Chief Designer Mikhail L. Mil of OKB-329 on this issue, but he was less than enthusiastic. Mil told one of his deputies:

I simply don't want to get mixed up in this. just imagine: a man flies into space, makes a couple of /oops around the globe, the whole world applauds, and the superstar begins his return to the Earth and then—bang! Something happens to him. Who is to blame? We will be! No, we won't be taking part in this *undertaking*.⁵⁸

Also considered was a huge umbrella-type brake for landing. All these exotic ideas were eventually abandoned, and by April 1958, the engineers adopted a simple parachute system. In addition, because of the large mass of heat protection, the engineers decided at an early stage to return only a portion of the spacecraft from orbit—that is, there would be a special "descent apparatus" that would carry the lone passenger. This compartment would be attached in orbit to an instrument module.

The next major problem was also resolved in April and May: the shape of the descent apparatus capsule. Feoktistov's group examined several designs, including cones of different lengths and sizes, half spheres, and full spheres." The last shape was finally chosen for three major reasons: a sphere would not require complicated attitude control devices during reentry to maintain dynamic stability. A sphere also offered increased internal volume relative to surface area. Finally,

55. Rex Hall. "Soviet Civilian Cosmonauts." in Michael Cassutt, ed. *Who's Who in Space The International Space Year Edition* (New York: Macmillan, 1992), p. 291. The others in Feoktistov's group were K. S. Shustin, O. V. Surguchev, M. S. Florianskiy, G. Z. Davletshin, V. P. Kurayev, Ye. N. Iornonosova, V. G. Vartanyan (computations), A. A. Alimov, N. I. Beresnev, L. I. Dulnyev, A. A. Kochkin, V. Ye. Lyubinskiy, O. C. Makarov, V. I. Petrov, N. M. Tereshenkova, D. M. Ego (layout scheme, design elements, and so on), V. G. Suprun (life support systems), V. A. Yazdovskiy (measurement), P. V. Flerov, and Ye. N. Tsererin (landing system, program of experimental work). See Raushenbakh, ed., *Materialy po istorii*, p. 212.

56. N. Chentsov. "World Famous, But Secret in Every Way" (English title), *Nauka i zhizn* no. 2 (February 1991), 102–07; Lardier, *L'Astronautique Soviétique*, p. 121.

57. Lardier, *L'Astronautique Soviétique*, p. 121.

58. Colovanov, Korolev, p. 600.

59. One conception looked almost exactly like the Apollo Command Module.

spheres would be subject to lower thermal stresses because of the increased surface area. The engineers were aware that a more complex shape such as a cone would reduce g-loads during reentry as well as allow for some control at landing, but Korolev understood that these advantages were relatively unimportant in the face of the primary limiting factor—time. The selection of the shape of the descent apparatus, which was assumed to be the most difficult task, was evidently a breakthrough in the entire design process, and it was at this point that Korolev privately decided to propose and support the entire project at a governmental level.⁶⁰

In early June, Tikhonravov and Feoktistov summarized the research done so far for Korolev, eliciting the latter's full approval. There were subsequent discussions in the next months with leading specialists from various other divisions at OKB-1. Then the four men primarily responsible for the work—Korolev (Chief Designer of OKB-1), Bushuyev (Deputy Chief Designer of OKB-1 for Space Technology), Tikhonravov (Chief of OKB-1's Department No. 9), and Feoktistov (Group Chief for Piloted Space Apparatus)—prepared and signed a formal and preliminary report on the research on August 18, 1958. The document, titled "OKB-1 Report. Materials on the Preliminary Work on the Problem of the Creation of an Earth Satellite with Humans on Board (Object OD-2)," was a nine-part thesis, plus an introduction and a conclusion, which included sections on:

- Primary flight characteristics
- The layout scheme for Object OD-2
- The shape of the descent apparatus and problems of stability
- The composition of equipment, landing systems, and layout of the descent apparatus
- Heat protection of the descent apparatus
- Problems of heat cycles in orbit
- Control and orientation systems
- Tracking and communications
- The program of experimental work⁶¹

The paper contained four different possible variants of the piloted OD-2, all with a similar two-compartment configuration: the conical "instrument section" and the spherical "descent apparatus." The latter was a classic sphere of about two and a half meters diameter, which served as the crew compartment as well as the reentry module for the single passenger. All the variants were equipped with a large ejection seat for the crewmember to use during the descent to Earth's surface. In three of the variants, a large conical-shaped pressurized compartment, the instrument section, which housed all the electronics and control systems for the spacecraft, crowned this descent apparatus sphere. The conical section was evidently derived from the main body of the Object D scientific satellite launched as Sputnik 3, which suggests a lineage all the way back to Tikhonravov's original 1954 document on space exploration. In the fourth variant, the instrument section was in the form of a torus at the base of the sphere. All four conceptions had a large engine—the "braking engine unit"—at the apex of the cones, to perform reentry burns. Depending on the variant, the length of the sphere-cone combination was about four and a half to six meters. The diameter of the combination on the pad for all the versions was just over two and a half meters. The mass of the descent apparatus was just over three tons."

60 Ishlinskiy ed *Akademi S P Korolev* p 506

61 A slightly edited version of the document has been published as S P Korolev K D Bushuyev M K Tikhonravov and K P Feoktistov "OKB 1 Report Materials on the Preliminary Work on the Problem of the Creation of an Earth Satellite With Humans on Board (Object OD 2)" (English title) in Raushenbakh ed *Materialy po istorii* p 20-119 Feoktistov's "counterpart" for the reconnaissance satellite was Ye F Ryazanov a veteran from Tikhonravov's group at NII 4

62 *Ibid* pp 41-49 71

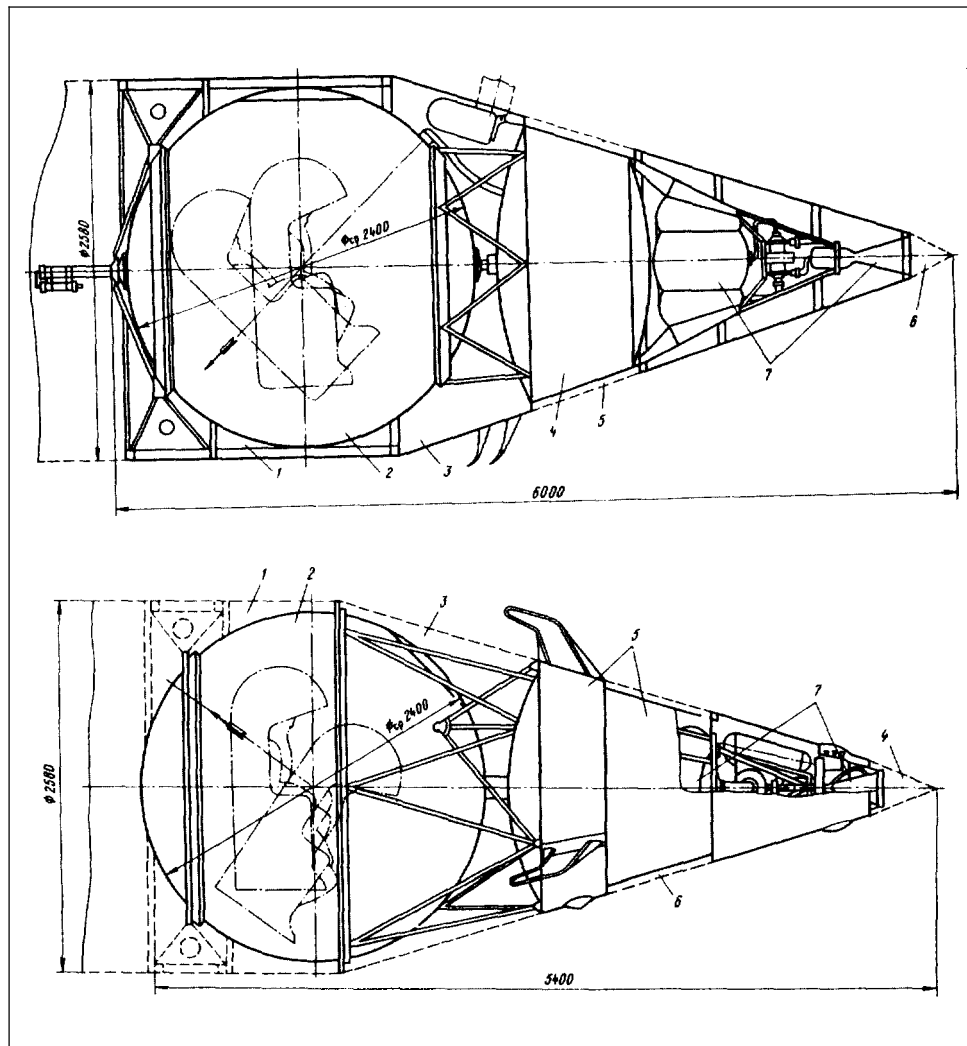

Shown here are two conceptions of the Object OD-2 spacecraft, which was the first design for an orbiting piloted ship in the Soviet Union. Dating from August 1958, the OD-2 design was changed by early 1959 into the ship that was later named Vostok. Both of these conceptions incorporated a spherical return capsule for the lone pilot, a layout that was retained for Vostok. Note the conical instrument module on the right of each spacecraft, very much similar to the Object D satellite launched as Sputnik 3 (reproduced from B. V. Raushenbakh, ed. *Materialy po istorii kosmicheskogo korablya "Vostok"* (Moscow: Nauka, 1991)).

From the writing in the document, it seems that variant number one was the favored version, a five- to five-and-a-half-ton spacecraft capable of ten days crewed orbital spaceflight. To account for a failure in the braking engine unit, the engineers had calculated that a circular orbit at 250 kilometers would allow the descent apparatus to reenter by normal decay after ten days, which was the length of safe operation of the on-board life support system. After reentry, the single passenger would eject out from the spherical capsule at an altitude of eight to ten kilometers and land separately from the main spacecraft. Although provisions were taken in case of a water landing, the descent apparatus was designed to touch down on land because this

would provide a modicum of secrecy to the entire operation and also simplified rescue and survival procedures. Korolev had a strong dislike of parachute recovery systems, hence his preference for unusual methods of descent, but he agreed to a parachute system in this case because that would ensure a quicker design process. Ballistics calculations, however, proved that to ensure a soft-landing on Earth, parachutes of huge size as well as extra landing engines would be required, adding significant mass to the spacecraft. To circumvent the problem, the engineers decided to have the pilot eject at altitude. The descent apparatus would land separately.

A seven-part program of testing was identified in the document:

- Static testing on the ground for verifying the thermal protection the engine unit the life support system, the system of internal thermo-regulation and the catapult system
- Air testing of the catapult system in various conditions
- Rocket testing of the catapult system in various conditions with the aid of mannequins on R-2 and R-5 rockets
- Verification of the thermal coating in natural reentry conditions
- The development of the spacecraft for carrying dogs on ballistic trajectories to 130-150 kilometers
- One or two launches of dogs into 250-300-kilometer orbits
- The launch of a human into a 250-300-kilometer orbit

According to the document, the engineers would not implement any design changes in the spacecraft following the automated flights because it would be difficult to predict the consequences of such actions on a crewed mission. If government approval was granted, Korolev envisioned a first piloted orbital launch by December 1960 at the earliest."

Based on the August 1958 document, Korolev prepared an information package on the course of work on the OD-2 and had it circulated on September 15, 1958, to the other members of the Council of Chief Designers—Glushko, Pilyugin, Barmin, Ryazanskiy, and Kuznetsov—as well as to other senior officials in the government." By this point, Korolev was faced with a dilemma: whether to focus on the reconnaissance satellite or the piloted spaceship. Continuing both programs simultaneously would tax the resources of his organization, thus perhaps delaying both efforts. Clearly, he preferred the piloted spaceship program, but that would posit him in the precarious position of ignoring the needs of the defense sector, a charge that was paramount to treason. Feoktistov recalls, "The battle in the OKB (a fierce one!) went on for several months and Chief Designers and other specialists from leading organizations who were to participate in this work were called in." The real deciding factor, however, may have not been any internal consideration, but rather events thousands of kilometers from Kaliningrad, as the United States was beginning to take its first concrete steps toward piloted spaceflight.

In August 1958, President Eisenhower assigned the yet-to-exist formal successor to the National Advisory Committee for Aeronautics to develop and carry out the "mission of manned spaceflight." On October 1, the National Aeronautics and Space Administration (NASA) formally came into existence and inherited that goal. Just six days later, NASA Administrator T. Keith Glennan approved plans for a piloted satellite project, and the primary responsibility of

63 *Ibid* pp 116-18 Mikhail Rebrov A Star Traversing Cape Horn (English title) *Krasnaya zvezda* April 12 1994 p 2

64 Semenov ed *Raketno Kosmicheskaya Korporatsiya* p 633 The source mentions "directive organs" which was usually a euphemism for the Communist Party and the government

65 Ishlinskiy ed *Akademik S P Korolev* pp 506-07

66 Linda Neuman Ezell *NASA Historical Data Book Volume II Programs and Projects 1958-1968* (Washington D.C. NASA Special Publication (SP) 4012 1988) p 99

CHALLENGE TO APOLLO

coordinating the program was delegated on November 5 to the Space Task Group based at the Langley Research Center in Virginia, headed by Robert R. Gilruth. Among the many luminaries of this resourceful group were Maxim A. Faget and Christopher C. Kraft, Jr., both of whom, along with Gilruth, would play some of the more pivotal roles in the early years of the U.S. civilian space program. The "human in space" project was officially designated "Mercury" on November 26, and by early January 1959, McDonnell Aircraft Corporation's bid for designing and producing the vehicle was accepted from a list of ten companies.⁶⁷

These events in the United States did not pass without notice. The formation of NASA and Glennan's push for a piloted space project may have been pivotal during a meeting of the Council of Chief Designers in November 1958. Presentations were made on the suborbital program, the orbital spaceship, and the reconnaissance satellite. The council decided to move ahead first with the development of a piloted orbital spaceship. Work on the development of an automated reconnaissance satellite was moved to a secondary priority, and all efforts on suborbital piloted space programs ceased at this point after a full three years of research."

Armed with unanimous recommendations for orbital flight and no doubt using the events in the Mercury program as added weight, Korolev took his case to the Communist Party and the government. On January 5, 1959, the Central Committee of the Communist Party and the USSR Council of Ministers issued a decree (no. 22-1055) officially calling for biomedical preparations for a human spaceflight project." This document, still classified, was the first government decree issued in support of a Soviet "human in space" program. Actual language for the specific development of a piloted spaceship was included in a second, more detailed decree (no. 569-264), which was adopted by the Soviet leadership on May 22, 1959.⁷⁰ Interestingly, this second secret decree was primarily focused on the approval of an automated reconnaissance satellite program, but Korolev, with the help of Keldysh and Rudnev, had managed to insert the following line at the end of the document: ". . . and also a satellite designated for a flight of a human."⁷¹

The work on the OD-2 piloted spaceship was significantly accelerated as a result of these decrees. There were, however, at least two major design decisions prior to the signing of the final technical specifications for the spaceship. In the original conception of the OD-2, the instrument section was a large cone-shaped compartment fitted on the forward end of the spherical descent apparatus. In the interest of maintaining mass constraints, instrumentation would be designed that could be mounted on the exterior of the instrument section for work in vacuum. Although Feoktistov himself supported this approach, by early 1959, Korolev opted for a more conservative path—one in which all the systems on the instrument section were installed internally in a pressurized compartment. In his opinion, this would significantly cut down on the time needed to design and develop instruments capable of working in open space." The shape and configuration of the spacecraft also changed dramatically, with the instrument section now becoming a double-coned object fitted at the aft end of the sphere.

67 *Ibid* pp 102 139-40

68 Raushenbakh ed *Materialy po istorii* p 212

69 Gorkov. "History of the Space Program Resident of Star Town " Korolev had evidently first raised the issue of "piloted" as a serious proposal to the government—that is the Special Committee—in a memorandum in May 1957. Later in August 1958 he also managed to extract a show of support from NII 4 Director G. A. Tyulin. See Rebrov "A Star Traversing Cape Horn "

70 S. Shamsutdinov 'Sixty Years for Yu. A. Gagarin' (English title) *Novosti kosmonavтики* 5 (February 26-March 11 1994) 5-7

71 B. Ye. Chertok *Rakety i lyudi. Filii Podlipki Tyuratam* (Moscow Mashinostroyeniye, 1996) p 424

72 Ishlinskiy ed *Akademik 5 P. Korolev* p 508

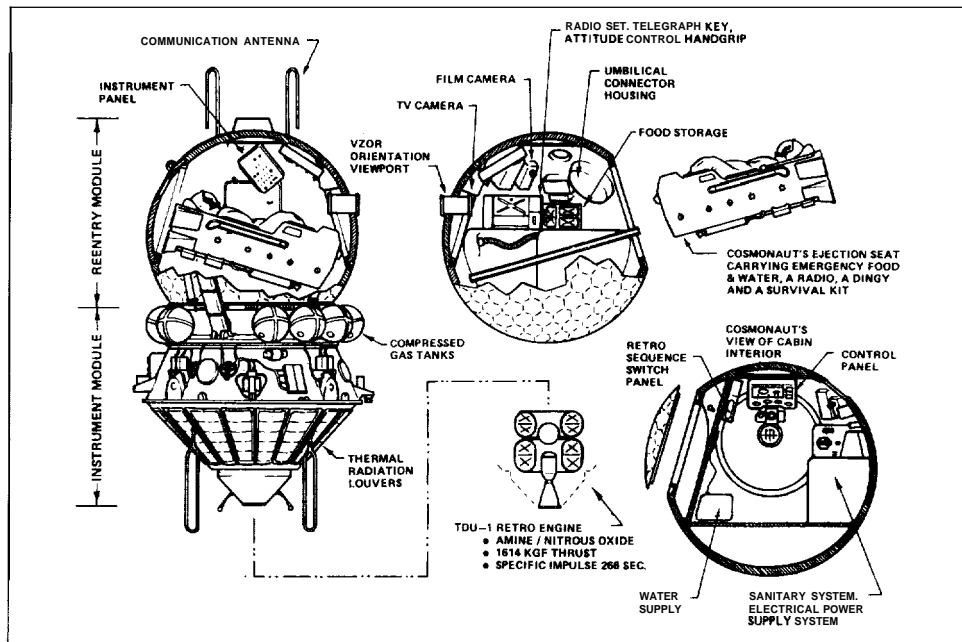

This is the piloted variant of the Object K spacecraft that later was called Vostok. The Vostok ship consisted of two basic modules: a spherical reentry module ("descent apparatus") for launch and recovery of the lone pilot and an instrument module ("instrument section") to carry the systems necessary for flight implementation. (copyright David R. Woods)

The second change had more long-range repercussions. Partly because of the operational limitations of a passive orientation system and partly to conserve resources, the original OD-1 design for the reconnaissance satellite was abandoned. Instead, Korolev adopted the design of the biological OD-2 for the spy satellite." Thus, the OD-2 became a dual-role spacecraft for military reconnaissance and human spaceflight, a common ancestry that was one of the more famous aspects of the early Soviet space program. Both missions required the recovery of portions of the satellite as well as a high degree of reliable systems operation; the use of a common bus would dramatically reduce the effort and time expended on an already overburdened OKB-1. The idea to merge the two disparate programs may even have been a strategy on Korolev's part to gain approval for the human spaceflight effort by using a reconnaissance satellite cover. The piloted program seems to have had little support from higher leaders, and in early 1958, it was still a very low-priority effort compared to the development of military ballistic missiles such as the R-7, the R-11M, the R-11FM, and the orbital reconnaissance satellite.

73 There are some inconsistencies as to exactly when the two designs were unified. In publishing the famous August 1958 report on the OD-2, the editor notes: "Minimum cuts [in the publication of the report] relate to the automated option of the satellite-ship, in which large-size photo-apparatus for survey of the Earth's surface were to be placed instead of the pilot. These options were later used as the basis of a separate program of development of the 'Zenit' photographic research satellite." See Raushenbakh, ed., *Materialy po istorii*, p. 212. This implies that the OD-2 design was already the basis for a common bus for both the piloted and reconnaissance satellite versions by August 1958. The official history of OKB-1, however, states that the unification occurred in 1959. See Semenov, ed., *Raketno-Kosmicheskaya Korporatsiya*, p. 99. The 1959 date may refer to the unification of the new design for the piloted spaceship (eventually used on the Vostok), which was markedly different from the OD-2.

CHALLENGE TO APOLLO

As a result of these changes, the designers dropped the original OD-2 designation and instead named the spacecraft "Object K." The "k" stood for *korabl*, the Russian word for "ship." Four different variants were postulated, the 1K, 2K, 3K, and 4K. The first was earmarked as a common prototype for both the reconnaissance and piloted variants. The second and fourth were exclusively dedicated to photo-reconnaissance missions, while the third was designed for piloted spaceflight.

Korolev approved the "complex plan for experimental work" on the piloted spaceship on March 17, 1959, which led to the completion of the draft plan of the Object 1K the following month. Comprising "only a few tens of pages of text and sketches," it allowed the designers, instrument subcontractors, electricians, and test specialists to begin verifying the layout on mock-ups of the spacecraft." Partly to have a dedicated facility for producing the new spacecraft, the Military-Industrial Commission institutionally transferred an old plant on the other side of Kaliningrad to OKB-1. During World War II, this plant and its associated Central Artillery Design Bureau had produced almost half the field guns in the Soviet Union, but as the missile age dawned in Russia, it was fast becoming an obsolete remnant of the past. By the mid-1950s, with a change of name to the Central Scientific-Research Institute No. 58 (TsNII-58), the organization had started mass production of fast neutron nuclear reactors for the Soviet economy. When Korolev needed an extra plant to focus on the development of new solid-propellant ballistic missiles as well as the production of new spacecraft, Ustinov agreed to give the plant and its personnel wholesale to the chief designer. On July 3, 1959, TsNII-58 was attached to OKB-1 as its "Second Territory." Korolev's engineers soon arrived with their drawings of the Object K, cementing the old artillery plant's giant leap into the future." Deputy Chief Designer Bushuyev, the space systems chief at OKB-1, was transferred to manage operations at the plant, overseeing the manufacture of all spacecraft at Korolev's enterprise. The very first casings of the spherical descent apparatus rolled off the lines the following month.

The Object K spacecraft, as it emerged in 1959, was a two-section spacecraft with a mass of approximately 4.73 tons in its crewed variant. Of this, the descent apparatus was 2.46 tons, while the instrument section was 2.27 tons. The engineers informally called the descent apparatus *sharik* ("ball"). The overall length of the spacecraft without antennae was 4.4 meters, while the maximum diameter was 2.43 meters.

The spherical descent apparatus, which had an internal volume of just over one and a half cubic meters, was a single-seat capsule covered completely with heat-resistant coating to protect it during reentry. The thickness of the thermal coating varied between just over three and eleven centimeters, the latter on the side that would face the atmosphere during reentry. The two-and-three-tenths-meter-diameter capsule had three one-meter-diameter hatches, one for recovery parachutes, one for access to instrumentation, and one for entry and exit by the pilot. In addition, there were three portholes with refractory glass located on the module for the crewperson to carry out optical observations, two of which had controllable shutters to block out the Sun's rays. The bulk of the internal volume in the descent apparatus was taken by a large

74. For the "complex plan for experimental work." see Biryukov. "Materials from the Biographical Chronicles," p. 241. There is some confusion as to the date of completion of the 1K draft plan. One source says it was completed in April 1959. See Chertok, *Rakety i lyudi*, p. 423. Another source says late May 1959. See Ishlinskiy, ed., *Akadernik S. P. Koroleu*, p. 509. A third source says April 1960. See Semenov, ed., *Raketno-Kosmicheskaya Korporatsiya*, p. 108.

75. Semenov, ed., *Raketno-Kosmicheskaya Korporatsiya*, pp. 67-68, 633; Chertok, *Rakety i lyudi*, p. 274, Ishlinskiy, ed., *Akadernik S. P. Koroleu*, pp. 326-27, 342-44, 348, 414; Sergey Khrushchev, *Nikita Khrushchev krizisy i rakety vzglyad rznutri tom 2* (Moscow, Novosti, 1994), p. 410. Note that Khrushchev incorrectly implies that the absorption of the plant occurred in 1962.

ejection seat weighing 800 kilograms placed at an angle to the horizontal; it contained a space-suit ventilation system, a catapult system, pyrotechnical devices, and parachute systems. The porthole directly forward of the pilot carried an optical device named Vzor ("view"), which would allow manual control over attitude. An instrument panel was located above the Vzor device, while there was a Topaz TV camera below it to provide internal views of the capsule during flight. The control panel had instrumentation for indicating air pressure, temperature, humidity and composition, as well as pressure in the attitude control propellant tanks. Controls on the panel would also allow the pilot to carry out manual operation of the retrofire engine. A small partially visible rotating globe named *Globus* on the upper section of the Instrument panel showed the pilot the spacecraft's location over the surface of Earth. The pilot's control stick, a food container, the air regeneration system, an electrical clock, a second Topaz TV camera for side views, a radio receiver, a sanitary system, and electrical supply sources were located on the right hand side of the large ejection seat. Telemetry units and storage space for secondary equipment were located underneath the seat.

Initially, Korolev had pressured Chief Designer Ivan I. Kartukov at OKB-81 in Moscow, the leading designer of solid-propellant rocket accelerators for Soviet tactical missiles, to design a full-scale launch escape system with a tower similar to Mercury's. Kartukov's design, however, proved to be too heavy, and despite continuing pressure from Korolev, Kartukov refused to lighten his tower system, fearful that a less robust system would put the lives of pilots in danger. Korolev's engineers instead proposed using an ejection seat, which would serve as a means of escape in case of an emergency during launch up to the first forty seconds. In the event that the launch parameters deviated from accepted levels, a command from ground controllers could blow the hatch on the descent apparatus and eject the pilot in his seat out of the capsule. Although unable to produce a workable launch escape system, OKB-81 did participate in designing the complex hatch system for the ejection seat.

For internal atmosphere, Soviet biomedicine specialists selected a cabin pressure equivalent to 755–775 millimeters of mercury (mm Hg), or about one atmosphere, and a 79/21 nitrogen-oxygen composition (essentially the same as Earth's surface). This was in contrast to early U.S. designs, which had a cabin pressure of 258 mm Hg, about one-third of an atmosphere, and a pure oxygen environment. For Soviet engineers, the choice was driven by concerns for simplicity and shorter development time. While the oxygen-nitrogen system had the advantage of significantly lowering the danger from internal fires, unlike the American system, the pilot would, however, be exposed to the possibility of suffering from decompression in case the crewmember had to switch life support from the spacecraft to his or her suit. For oxygen replenishment, the Soviets chose a "chemical bed" system based on alkali metal superoxides, which would release oxygen as it absorbed carbon dioxide. A cooling and desiccation unit consisting of a heat exchanger would ensure the required temperature and humidity in the cabin. Much of the technology for life support systems had come directly from the vertical flights of dogs into the upper atmosphere via modifications of the R-2 and R-5 missiles.

Communications with the spacecraft would be maintained by several systems. These included the Signal ("signal") system on 19.995 megahertz for the transmission of simple telemetry. The carrier was on-off keyed, with the key rate equal to the pilot's pulse rate and the off duration being proportional to the crew member's chest width for respiratory measurements. The system also multiplexed parameters for the retrofire burn. A second system named Tral-PI would provide supplementary radio-telemetry capacity. For two-way voice communications between the spaceship and the ground, the lone pilot would use the Zarya ("dawn") system on VHF and UHF. Ground controllers also wanted to have a relatively constant video feed during the mission: this was the job of the Tral-T system, which would transmit images from the two Topaz TV cameras aboard the ship. For the landing stages of the mission, there were the *Peleng* ("bearing") system comprising a shortwave beacon for position determination.

CHALLENGE TO APOLLO

during and after reentry and the Raduga ("rainbow") system for radio communications. Finally, there was the *Rubin* ("ruby") system for trajectory measurement during the flight.

The pressurized instrument section was composed of two cone-shaped compartments with their blunt ends facing each other. Its primary role was to carry instrumentation for ensuring piloted orbital flight. Made of an aluminum alloy, the main element of the module was a large engine for the retrorocket burn. Designated the Braking Engine Unit No. 1 (TDU-1), it had a vacuum thrust of 1.64 tons and was fed by 280 kilograms of an amine-based fuel and nitrous oxide. Maximum burn time would be forty-five seconds. Internally, the module contained the following systems: instrumentation for guidance, control, and orientation; units for "command-logic control"; an electrical supply system; apparatus for radio communications; telemetry instrumentation; and a programmed logic clock. The exterior contained tanks for a nitrogen-based attitude control system that used a dual system with eight nozzles each with a thrust of one and a half kilograms each. Additional systems on the outside included a solar sensor, a radiative thermal regulation system using blinds, and several small spheres housing oxygen for use in cases of emergency by the pilot. Eleven antennae protruded from various locations on the instrument section. Of these, three were for the Signal system, four were for the Zarya system, two were for telemetry, and two were for "radio-link" commands. The entire section was not designed for recovery and was to burn up in the atmosphere following separation from the descent apparatus."

The TDU-1 would operate once during the mission. Prior to nominal reentry, the capsule would orient automatically by means of a solar sensor to align it to correct attitude. A traditional ballistic reentry would follow without any further attitude control. OKB-1 engineers designed the sphere in such a way that the center of gravity of the capsule was behind and below the pilot, thus ensuring the module would be in correct orientation to eject the crewmember in the seat at the correct angle. After reentry, at an altitude of approximately seven kilometers, bolts securing the pilot's hatch would sever explosively, blowing the cover away from the descending spacecraft. Just two seconds later, the crewmember and the couch would eject together with the aid of two powerful solid-propellant rockets, descending together to about four kilometers altitude, at which point the pilot would separate and land by parachute at a calculated impact velocity of five meters per second.

Both the Soviets and the Americans, while driven by many of the same considerations in building the first piloted orbital spacecraft, deviated philosophically in one important area. Soviet engineers designed Object K with the goal that an entire mission, from launch to landing, could be carried out without the pilot touching a single control inside the ship. While there was provision for a pilot to manually orient the vehicle and fire the retrorocket in case of an emergency, Soviet designers never considered the pilot on board anything more than a passenger. Although partly motivated by concerns about psychological stability of the pilot in outer space, this was primarily because it was not an aviation firm that was in the driver's seat, but rather OKB-1, which had only designed strategic ballistic missiles and a few high-altitude

76 V. P. Glushko, ed., *Kosmonavtika entsiklopediya* (Moscow: Sovetskaya entsiklopediya, 1985), pp. 65-66. K. P. Feoktistov, "The Development of Soviet Piloted Space Ships (Until the Early 70s)" (English title), in B. V. Raushenbakh, ed., *Issledovaniya po istorii i teorii razvitiya aviatsionnoy i raketno kosmicheskoy nauki i tekhniki* (Moscow: Nauka, 1981), pp. 94-122; G. V. Petrovich, ed., *The Soviet Encyclopedia of Space Flight* (Moscow: Mir Publishers, 1969), p. 223; Mozhgorin, et al., eds., *Nachalo kosmicheskoy ery*, pp. 272, 287; Ponomarev, "2 June—75 Years From the Birth"; Lardier, *L'Astronautique Soviétique*, pp. 122-23; R. F. Gibbons and P. S. Clark, "The Evolution of the Vostok and Voskhod Programmes," *Journal of the British Interplanetary Society* 38 (1985): 3-10; Edward Clinton Ezell and Linda Neuman Ezell, *The Partnership: A History of the Apollo-Soyuz Test Project* (Washington, DC: NASA SP-4209, 1978), pp. 64-67; Golovanov, *Korolev* p. 621.

cabins for dogs. While a number of aviation enterprises made very significant contributions to the Object K effort, they worked as subcontractors to OKB-1. Furthermore, the heavy emphasis on automation may have also been an issue of control and reliability—that is, OKB-1 engineers not only did not trust a pilot's capability to function adequately, but they also wanted to design the craft, fly it, and land it all on their own. Undue automation of piloted space vehicles was an issue that would dominate the design of all Soviet crewed space vehicles and, some would say, have a negative impact on the course of events in the 1960s.

Activity in the Object K program intensified progressively through 1959. In late 1959, the first "boilerplate" spacecraft was delivered from the OKB-1 plant. Feoktistov recalls that "it was an awesome sight" to finally witness the creation of his design team's handiwork." At the same time, Korolev assigned two of his most longtime associates, Petr V. Flerov and Arvid V. Pallo, to direct a series of landing tests of the descent apparatus to test out the critical parachute system. Flerov was quite possibly one of Korolev's most longstanding friends; they had met in the late 1920s when Korolev was flying gliders as a young man. For these drop tests, General Designer Oleg K. Antonov personally consigned a specially modified "pot-bellied" An-12 aircraft to OKB-1. Flerov and Pallo took a number of shariks to a military airfield at Saryshagan near Lake Balkhash and dropped the capsules from altitudes of 8,000 to 10,500 meters. The primary landing parachute itself, designed by the Scientific-Research Institute of the Parachute Landing Service, headed by Chief Designer Fedor D. Tkachev, had a maximum volume of 330 cubic meters and allowed touchdown at ten meters per second.⁷⁶ Of the five drop tests, one was an outright failure when the hatch failed to open, thus preventing seat ejection. The fifth and last *sharik* carried dogs. Although the touchdown was successful, the capsule unexpectedly rolled down the hills out of sight of rescuers. After a long search, Flerov and Pallo finally found the dogs "worn out but in one piece."⁷⁷ It was on April 10, 1960, that Flerov and Pallo returned from Saryshagan and reported back to Korolev that the parachute system was ready for flight. It was a critical milestone, which allowed him to make concrete plans for the first automated space missions of Object K.

The spacesuit and ejection system were developed and designed by Chief Designer Alekseyev's Plant No. 918, which had gathered significant experience during the vertical dog flights. There was much debate about the utility of a pressurized spacesuit during an orbital mission, with OKB-1 engineers believing that the redundant safety systems in the spacecraft would eliminate the need for a separate suit. Alekseyev, supported by several prominent biomedicine specialists, believed exactly the opposite. Despite the fact that inclusion of a suit would add more mass to the spacecraft, Korolev ultimately agreed to their demands and in mid-1960 decided to include a suit. Alekseyev's engineers eventually designed a suit, the SK-1 *Sokol* ("falcon"), which was completely autonomous from the spacecraft's air regeneration system. In case of depressurization, the suit could provide about four hours of backup support for a pilot. Of the eleven-and-a-half-kilogram mass of the suit, the helmet alone had a mass of just over three and a half kilograms. Tests of the new spacesuit and the ejection seat, both designed and built under Alekseyev, were carried out in July–September 1960 during eight drops from an 11-28 aircraft. One of the participants was famous Soviet parachutist Petr I. Dolgov, who was ejected at an altitude of 7,000 meters from the ejection seat.⁸⁰

77 Ishlinskiy, ed., *Akadernrk S. P. Korolev*, p. 509.

78. Glushko, ed., *Kosmonautika entsrklopediya*, p. 66. The designer at the Institute in charge of parachute development was N. A. Lobanov.

79 Golovanov, *Korolev*, p. 605.

80 Lardier, *L'Astronautique Soviétique*, p. 122; V. Svergun and V. Ageyev, "The Road to 'Vostok'" (English title), *Aviatiya i kosmonautika* no. 2 (March–April 1994): 42–43. Dolgov, a pilot at the famous M. M. Cromov Flight-Testing Institute, died in an unfortunate accident on November 1, 1962, during a parachute drop from 24,500 meters as part of the Volga program. See Yaroslav Colovanov, "Cosmonaut No. 1 Slander" (English title), *Izvestiya*, April 3, 1986, p. 6.

The life support system for the spacecraft was developed by OKB-124, headed by Chief Designer Grigoriy I. Voronin. At least fifteen full-scale tests of the system were conducted from 1960 to 1961 of durations between one and fifteen days, confirming the basic design selection of the system." Once again, the experience with the dog flights proved to be critical in terms of meeting the given timeframe.

Korolev had originally envisioned the use of a powerful solid-propellant rocket engine for the retrorocket burn. An initial contract for the job had been assigned to NII-125, where another of his old prewar associates, Yuriy A. Pobedonostsev, was appointed to develop the engine. The contract stipulated a delivery by the first quarter of 1960. There was, however, much uncertainty with this effort, no doubt related to the poor state of advanced Soviet solid-propellant rocketry at the time. As insurance, Korolev's deputies Tikhonravov and Bushuyev recommended a parallel liquid-propellant effort." The obvious choice for designing such an engine would have been Glushko's organization, but he was evidently not interested. As was often the precedent in such cases, Korolev turned to one of his most trusted associates, Chief Designer Aleksey Isayev of OKB-2. Clearly as talented and resourceful as Glushko, Isayev, however, lacked the former's unfettered ambition. A quiet man with an overwhelming drive for work, Isayev had stood in Glushko's shadow through the 1950s, although some of Isayev's original design schemes had been appropriated by Glushko for preliminary designs of the R-7 ICBM engines. Isayev's crowning achievement in the 1950s had been the development of an engine for the Soviet Union's first air defense missile, the V-300, for which in 1956 he received the Hero of Socialist Labor decoration, the USSR's highest civilian award.

Isayev's design bureau had nominally been part of the old NII-88 but was separated into an independent organization, the new OKB-2, on January 16, 1959." Just one month later, when Korolev entrusted Isayev with the retrorocket engine for Object K, Isayev was said to have come back to his design bureau and calmly announced to his senior staff: "[Korolev] has proposed that we quickly carry out one small but very important work: returning a human from space to the Earth." Through the ensuing months, Korolev met with Isayev several times, asking him detailed questions on the development program for the TDU-1, but he never once recommended changes, thus implicitly entrusting enormous faith in Isayev's abilities. Within just



Chief Designer Aleksey Isayev was responsible for the design of the majority of rocket engines for spacecraft in the Soviet space program. His first big contract in the space field was the design of the Object K (or Vostok) reentry firing engine, the TDU-1. His organization, OKB-2, also designed many other engines for air defense and long range ballistic missiles (files of Peter Gorin)

81. Lardier, *L'Astronautique Soviétique*, p. 122.

82. V. K. Kupriyanov and V. V. Chernyshev, *I vechernyy start . . . rasskaz o glavnom konstruktore raketnykh dvigateley Alekseya Mrkhaylouichye Isayeuye* (Moscow, Moskovskiy rabochy, 1988), pp. 123-24.

83. *Ibrd.* p. 219. The Independent OKB-2 was created by the merger of the old NII-88 OKB-2 and NII-88 OKB-3. The former had been headed by A. M. Isayev and the latter by D. D. Sevruk.

84. *Ibrd.* p. 125. The lead designer of the TDU-1 at OKB-2 was N. G. Skorobogatov.

seven months of receiving the task. Isayev's OKB-2 had begun ground test firings of the TDU-I engine. The tests began on the evening of September 27, 1959, under the direction of Isayev's Deputy Vladimir G. Yefremov, culminating in a major failure on the fifth test because of a valve design error. After new valves were installed, the next ten tests were without mishaps, removing any doubts as to the design of the engine. On April 25, 1960, Isayev reported back to Korolev that the engine for the first piloted orbital spaceship was ready. It was less than a month prior to the launch of the first automated version of Object K.⁸⁵ The solid-propellant engine was never built.

The Object K program was the first large-scale project that opened the door to cooperation outside the design bureaus of the original members of the Council of Chief Designers. In fact, with the exception of Korolev's OKB-1, none of them had a major role in the design of the spacecraft. When Pilyugin's department at NII-885 refused to take on the job, Korolev contracted a team at NII-1 to develop the *Chayka* ("seagull") attitude control system for the vehicle. This team was headed by a forty-three-year-old vibrations specialist named Boris V. Raushenbakh, who had been conducting research since 1955 on the "controlled motion of space apparatus."⁸⁶ By 1959, Raushenbakh's small team had created the first Soviet attitude control system for the Ye-2A lunar probe, one of which, Luna 3, became the first spacecraft to take pictures of the far side of the Moon. Raushenbakh, a man of many talents, had led a remarkably interesting life and was one of the many in the space program who had known Korolev during his apprenticeship days at NII-3 in the 1930s. He was also one of those who had been sent off to the Gulag. In March 1942, he had been arrested by the secret police simply for possessing a German surname. Having survived time at a labor camp where as many as ten prisoners were dying per day, he later worked for a few years at Bolkhovitinov's famous design bureau before returning to Moscow as a "free" man in 1948. Given his increased involvement with Korolev's projects, Raushenbakh's resourceful team was transferred wholesale from NII-1 to Korolev's OKB-1 on January 6, 1960.⁸⁷

Attitude control was one of the most important elements of the Object K spacecraft, not the least because of the necessity to orient the vehicle in the correct direction to fire the main deorbit engine. Discussions on Object K's orientation system began in early 1959. Originally, Tikhonravov's team decided to simply use the Luna 3 system, which used the Moon as a point of reference to posit the vehicle in the correct attitude. This plan fell through when it became clear that the much brighter Sun would interfere with the light from the Moon. There were also potential complications caused by the different phases of the Moon as visible from Earth. By April-May 1959, OKB-1 finally issued a report selecting solar orientation as the chosen mode for Object K. When the system operated, it would posit the spacecraft such that the axis of the main retrorocket's nozzle would be toward the Sun—that is, the thrust would be directly in the direction away from the Sun. The biggest advantage of using the Sun was that optical sensors would not mistake the Sun for any other celestial body. For a nominal reentry, the Sun would have to be "ahead" of the spacecraft, in the sunrise phase, before its passage across the local zenith. There were also two other systems of orientation on the spacecraft: an automatic system, which responded to Earth's

⁸⁵ Colovanov *Korolev* p 614 In total the TDU I engine underwent eighteen stripped down firings followed by sixteen full scale ground firings

⁸⁶ V P Legostayev "18 January—75 Years From the Birth of Soviet Scholar and Designer B V Raushenbakh (1915)" (English title) *Iz istorii aviatsii i kosmonavtiki* 64 (1990) 4-7

⁸⁷ *Ibid* Semenov ed *Raketno Kosmicheskaya Korporatsiya* p 633 Colovanov *Korolev* pp 572-74 While Raushenbakh's department was responsible for overall design the actual Grif sensors for the attitude control system were manufactured by the Central Design Bureau No 598 (TsKB 598)

infrared radiation and used a complex of sophisticated gyroscopic devices, and a manual system, which duplicated the solar system. For the latter, the pilot would use the Vzor optical device and observe the Earth moving below the center of the instrument. This would allow the pilot to control horizontal direction or yaw. Using a circular mirror, the pilot could also control pitch and roll.⁸⁸

Given precedent, the radio and telemetry systems for the spacecraft would have been developed by Ryazanskiy at NII-885, but his existing workload necessitated bringing in several other organizations. NII-695, under Chief Designer Yuriy S. Bykov, designed the Signal, Peleng, Zarya, and Raduga telemetry-communications systems, while the Experimental Design Bureau of the Moscow Power Institute, under Chief Designer Aleksey F. Bogomolov, developed the Rubin trajectory measurement system and the Tral-PI telemetry system."

The original council members continued to provide systems for the launch vehicle: Glushko's OKB-456 provided engines; NII-885 of Ryazanskiy and Pilyugin designed the control systems; Barmin's GSKB SpetsMash modified the launch complex; and Kuznetsov's NII-944 developed gyroscopes. The creation of a launcher proved to be a long and complicated process for the Council of Chief Designers. By early 1958, the two-stage R-7 in its "space" variants, the 8K71PS and the 8A91, could at best lift 1,400 kilograms into low-Earth orbit. To satisfy the immediate requirements of launching lunar probes and piloted spacecraft, an increase of three-fold over that weight was required. Proposals for building a new third stage for the basic R-7 booster had been tabled in the summer of 1957, and soon after, designers began work on two unrelated upper stage engines, one at Korolev's OKB-1 and one at Glushko's OKB-456." By the end of 1957, the Council of Chief Designers had finalized plans for two new modifications of the R-7, the 8K72 and the 8K73 boosters. Both were to use the basic 8K71 R-7 ICBM augmented up by different upper stages for launching lunar probes and reconnaissance satellites. The Soviet government ratified the effort on March 20, 1958.

At the center of the decision to develop two different launch vehicles was a minor rift between Chief Designers Korolev and Glushko—an altercation that in less than five years would evolve into the most acrimonious and infamous battle within the Soviet space program. When plans for the upper stage engines for the R-7 were originally drawn up in mid-1957, Korolev assumed that any new engine would be fueled by the same combination of propellants as the booster proper—that is, liquid oxygen (LOX) and kerosene. Glushko, however, had been impressed by a new synthetic propellant named unsymmetrical dimethyl hydrazine (UDMH) developed for the first time in the Soviet Union by the State Institute for Applied Chemistry. According to the institute's data, the new component promised higher energy characteristics than the traditional LOX-kerosene combination. In a clear indication of his interests, in 1958,

88. B. V. Rauschenbach. "From the Development History of the Vostok Spacecraft." in J. D. Hunley, ed., *History of Rocketry and Astronautics, Vol. 20* (San Diego, CA: American Astronautical Society, 1997), pp. 156-57.

89. Mozzhorin, et al., eds. *Nachalo kosmicheskoy ery*, pp. 272, 287. Ponomarev. "2 June—75 Years From the Birth". Semenov, ed. *Raketno-Kosmicheskaya Korporatsiya*, p. 108. Others involved in the design of instruments for Object K included: NII-88 (the Mr-2 autonomous data recording device); TsKB-598 (the Vzor optical device and the Grif photo-electric sensors for the solar attitude control system); the M. M. Gromov Flight-Research Institute (the cockpit control panel); NII-137 (the explosive device for automated variants); NII-648 (the MRV-2M "radio-link" command systems); the All-Union Scientific-Research Institute for Power Sources (the power sources); NII-380 (the Topaz TV cameras); the Committee for State Security (KGB) and the Krasnogorsk Mechanical Plant (jointly the movie cameras for photography of Earth), and the State Scientific-Research Institute of Aviation and Space Medicine, the Biofizpribor Special Design Technology Bureau, the Scientific-Research Institute of Nuclear Physics of Moscow State University, and the Institute of Biomedical Physiology of the USSR Academy of Medical Sciences (jointly medicine, radiation dosimetric instrumentation, and food serving systems).

90. Vasily P. Mishin. " . . . He Said, "Here We Go!" English title). *Aviatsiya i kosmonautika* no. 4 (April 1991): 13-14. Varfolomeyev. "Soviet Rocketry that Conquered Space Part 3."

Glushko began the development of four new engines using UDMH, three in combination with nitrogen-derived oxidizers and the fourth in combination with LOX. It was the latter engine, the RD-109 with a vacuum thrust of just under ten and a half tons, which he intended to offer for use on the 8K73 lunar rocket. Korolev was not happy with this decision. His primary concern was time, and he strongly believed that Glushko would be unable to design, develop, and test the first Soviet rocket engine for work in vacuum with a completely new propellant combination by the deadline, which was late 1958. Despite entreaties to retain the LOX-kerosene combination, Glushko pursued work on the RD-109 engine. In this case, Korolev proved to be right. The tests of the engine were not finished in 1958, nor were they in 1959. Then the Council of Chief Designers formally abandoned any plans to develop the 8K73 lunar launch vehicle."

Luckily for Korolev, there had been a second option, a small thrust engine (just over five tons) designated the RD-0105, developed in his own design bureau. Engineers under Mikhail V. Melnikov at the OKB-1 had already created the small steering thrusters for the R-7 first-stage engines, whose performance characteristics could be scaled to match those needed for an upper stage. Korolev, still needing a turbopump to complete the engine, was saved by the help of a new entrant to the space program. In 1957, he had been impressed by a report on the creation of a new restartable LOX-kerosene rocket engine developed in Voronezh at an aviation design organization, the OKB-154, headed by Chief Designer Semyon A. Kosberg." The fifty-four-year-old Kosberg had little interest in space or rocketry in general, content in his place in the aviation sector, but he was eventually swayed by Korolev's persuasive arguments to collaborate with him on a new rocket engine capable of firing in vacuum. Thus, Korolev and Kosberg signed a memorandum of understanding at Kaliningrad on February 10, 1958, which called for the delivery of the new RD-0105 engine in time for the first lunar probe launch attempts." The cooperation with an "outsider" was a slap in Glushko's face, but it worked in Korolev's favor. Combining a turbopump from Kosberg's organization with thrusters from Melnikov's group, the two design bureaus produced the RD-0105 engine in just nine months, ready for flight by August 1958. It was the first Soviet liquid-propellant rocket engine designed for use in vacuum.

The 8K72 rocket was fired nine times between September 1958 and April 1960 for the automated lunar probe program. Six of these launches were failures. The three successes were outstanding: the first probe to fly into solar orbit, the first human-made object to impact on another heavenly body, and the first probe to take pictures of the far side of the Moon. Calculations, however, proved that the lifting capacity of the 8K72, approximately four and a half tons into low-Earth orbit, would be just short of what was required for the piloted spaceship. Beginning in January 1959, Aleksandr S. Kasho, a senior engineer at OKB-1, thus led a team to modify the launcher to increase lifting capacity by 200 extra kilograms. A new upper stage engine was required. The original upper stage engine for the 8K72 had been a cooperative venture, but this time, Kosberg took the lone responsibility to improve the performance

91. Igor Afanasyev, "Absolutely Secret: N-1" (English title). *Kryiya rodiny* no. 9 (September 1993): 13-16. T. Varfolomeyev, "Readers' Letters: On Rocket Engines from the KB of S. A. Kosberg, and Carrers on Which They Were Installed" (English title). *Novosti kosmonautiki* 26 (December 18-31, 1993): 46-48; Varfolomeyev, "Soviet Rocketry that Conquered Space. Part 3": "S. P. Korolev's Letter to the Deputy Chairman of the SSSR Council of Ministers L. V. Smirnov" (English title). *Nauka i zhizn* no. 4 (April 1994): 79-80. The other three engines developed by Glushko using UDMH were the RD-216, the RD-218, and the RD-219. The RD-109 was also known as the GDÜ-10, or article 8D79.

92. The particular engine was the RD-0102 for the Yak-27V aircraft. This was the first Soviet restartable liquid-propellant rocket engine running on LOX and kerosene. See Vladimir Rachuk, "Best Rocket Engines From Voronezh." *Aerospace Journal* no. 6 (November-December 1996): 30-33.

93. Colovanov, Korolev, pp. 559-60; Biryukov, "Materials from the Biographical Chronicles." p. 240; V. N. Ivanenko, "On the Life and Activities of S. A. Kosberg (on His 80th Birthday)" (English title). *Iz istorii aviatsii i kosmonautiki* 49 (1984): 3-10.

characteristics of the engine, beginning work in September 1959. In the new version, the RD-0109 with a vacuum thrust of just over five and a half tons replaced the RD-0105 with a thrust of just over five tons.⁹⁴ To denote the difference from the 8K72 booster, a "k" was added to indicate use in the Object K program, thus becoming the 8K72K booster. This marginally modified launch vehicle had shorter burn times for all its stages, but compensated with the increased thrust of all engines, including the core. The total length with a new payload fairing for the piloted spaceship was more than thirty-eight meters, about five meters longer than the versions that launched the lunar spacecraft.

The piloted portion of the Object K program was one of three post-Sputnik space projects to emerge in the Soviet Union. Along with the military reconnaissance satellite effort and the lunar probe program, it allowed the USSR to gain a foothold in the cosmos. The United States also engaged in similar efforts, but by the end of the 1950s, the American civilian space program had a singular organizational platform. NASA, and a long-range vision that was far more integrative than any in the Soviet space program. The chief designers, led by Korolev, endeavored to keep pace with the institutional changes in the United States, with a flurry of letters and memos directed to the Soviet leadership. By 1960, change would come on the Soviet side, but with mixed results.

94 Varfolomeyev. "Soviet Rocketry that Conquered Space Part 3 " It is possible that there was a competitor variant to Kosberg's new RD-0109 engine

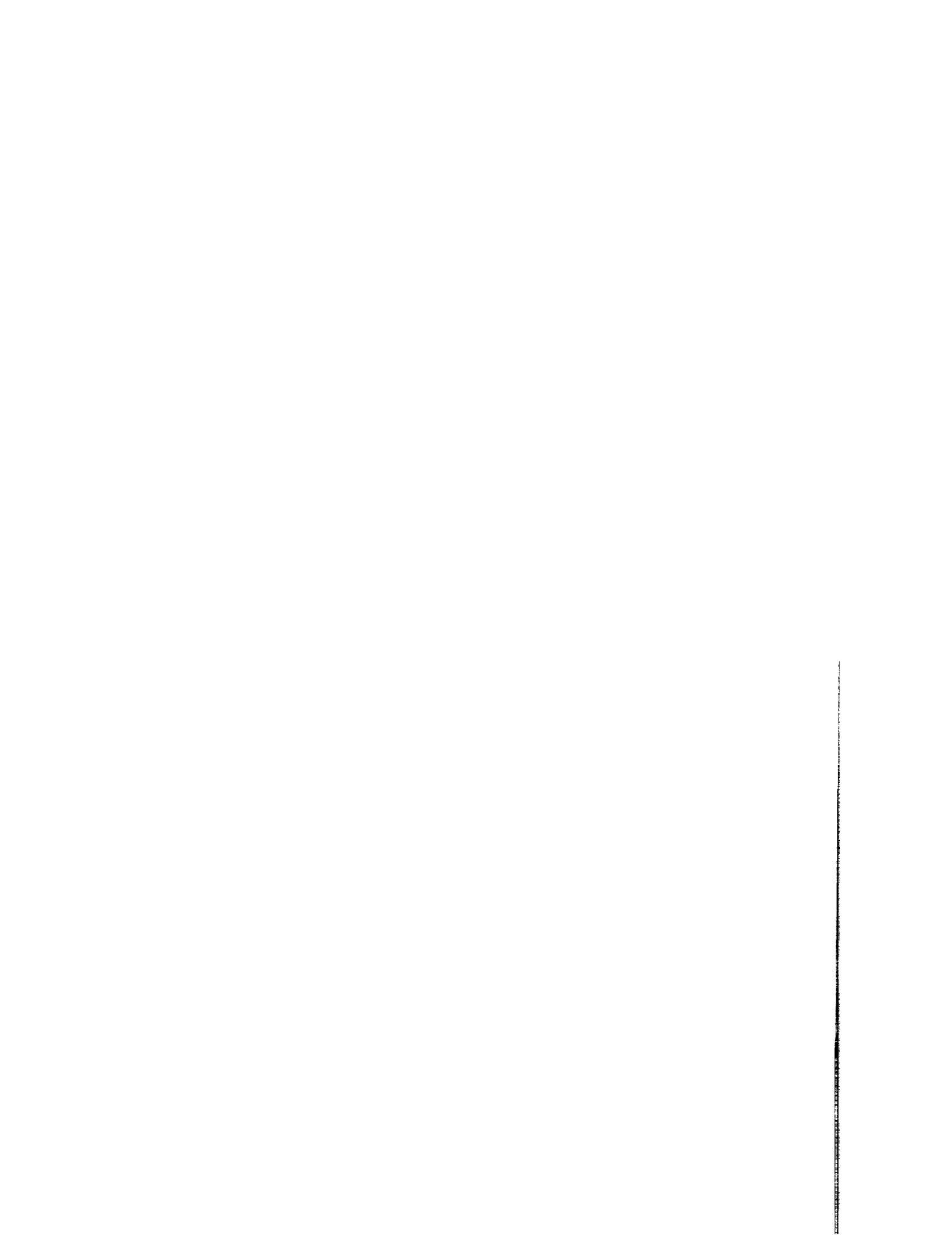



CHAPTER SIX

ORGANIZING FOR THE SPACE PROGRAM

The piloted portion of Object K was afforded a modicum of priority by the Soviet defense industry in 1959 and 1960, but the lion's share of funding in the sector was still focused on the development of strategic offensive systems, primarily long-range ballistic missiles. The Soviet space program, as distinct from the Soviet missile program, was still in its infancy, and it was a difficult transition, which was unknown or misunderstood in the West. A top-secret CIA-sponsored intelligence report in August 1959 noted that:

There is no direct evidence on the priority assigned to the Soviet space program. From the launchings of the Sputniks, from statements by Soviet scientists and high government officials and from the fact that hardware was diverted from the high priority missile program, we believe the inference can be drawn that the Soviet space exploration program has been assigned a very high priority.'

In 1959, there was, in fact, no official macro-level policy or priority on the Soviet space program. The defense management enterprises and the Central Committee Defense Industries Department, which had overseen ballistic missile development, were simply unprepared to make the transition from one to the other.

Pleas for Order

Engineering and scientific leaders such as Korolev, Keldysh, and Tikhonravov were seriously concerned about the lack of a coordinated policy on the Soviet space program. The launch of Sputnik in October 1957 prompted a flurry of discussions on the topic at the designer level, which eventually led these men to send a number of important letters and documents to the Soviet leadership. These appeals were formulated in two thematic directions—one aimed at establishing a management and industrial infrastructure to exclusively support a space program and the second aimed at establishing specific short- and long-range goals of such a program.

The first salvo on the organization theme came less than two months after the launch of Layka into space. In a letter titled "On the Establishment of New Powerful Industry for the Investigation of Cosmic Space," dated December 30, 1957, Korolev and Keldysh addressed both topics. Following the writings of Tsiolkovskiy very closely, the two listed the primary goals

1 U.S. Central Intelligence Agency "Soviet Capabilities in Guided Missiles and Space Vehicles" National Intelligence Estimate 11-5 58 Washington DC August 19 1958 as declassified February 15 1995 by the CIA Historical Review Program p 27

of a well-organized Soviet space program. These would be the development of oriented artificial satellites, the use of solar energy as a power source, the creation of satellites for photographing Earth's surface, the creation of space stations for extended use and the return of data from space, research on "a number of questions on orbiting the Moon." and "human flight across interplanetary space."² To facilitate these goals, the authors called for the establishment of new scientific-research institutes and design bureaus. As with many other letters of the time, it seems that the Soviet leadership did not respond favorably to the appeal. The first official governmental decree on the space program, on March 20, 1958, merely approved the automated lunar probe effort, without addressing any of the larger questions listed by Korolev and Keldysh.¹

During the summer of 1958, Korolev and Tikhonravov prepared a more detailed appraisal of the goals of the Soviet space program.⁴ This landmark document, also faithful to the Tsiolkovskiy vision, laid out the basis for much of the Soviet space effort during the 1960s, albeit with many delayed timeframes than originally proposed by its authors. Thematically, the letter was divided into four parts:

- Investigations using the R-7 and its three-stage modifications such as the 8K72
- Creation of new, more powerful launch vehicles
- Investigations using these new launch vehicles
- Basic scientific-research work for the development of interplanetary technology and search for newer achievements "in the road to the mastery of cosmic space."

The authors listed investigations using the R-7 and its three-stage modifications as:

- Creation of artificial satellites capable of:
 - a. Photography of Earth with recoverable film cassettes (1958-60)
 - b. Unlimited lifetimes and periods of operation (1961-65)
 - c. Existing in highly elliptical orbits around Earth (1961-65)
- Creation of apparatus for investigations of the Moon, including:
 - a. Ten to twenty-kilogram stations on the surface of the Moon (1958-61)
 - b. Artificial lunar satellites for photography (1959-61)
 - c. Satellites in elliptical orbit for circling the Moon and returning film cassettes back to Earth (1960-64)
- Creation of a piloted satellite with ballistic reentry in three stages (1958-60):
 - a. Development of heat protection for the return apparatus
 - b. Creation of test apparatus for suborbital testing
 - c. Creation of a piloted satellite for operation up to ten days

² This document has been reproduced in full as M. V. Keldysh and S. P. Korolev "On the Establishment of New Powerful Industry for the Investigation of Cosmic Space" (English title) in V. S. Avduyevskiy and T. M. Eneyev eds. M. V. Keldysh *izbrannyye trudy raketnaya tekhnika i kosmonavtika* (Moscow: Nauka, 1988) p. 241. The letter was said to have been sent to "directive organs" usually a euphemism for the USSR Council of Ministers and the Central Committee.

³ Yu. P. Semenov ed. *Raketno-Kosmicheskaya Korporatsiya "Energiya" imeni S. P. Koroleva* (Korolev RKK Energiya named after S. P. Korolev, 1996) p. 93.

⁴ This document has been reproduced in full in two different Soviet sources. See S. Korolev and M. Tikhonravov "Preliminary Considerations on the Prospects of the Mastery of Cosmic Space" (English title) in B. V. Raushenbakh ed. *Materialy po istorii kosmicheskogo korabl' "uostok"* (Moscow: Nauka, 1991) pp. 16-19. See also S. P. Korolev and M. K. Tikhonravov "On the Prospects of Work on the Mastery of Cosmic Space" (English title) in M. V. Keldysh ed. *Tvorcheskoye naslediyе Akademika Sergeya Paulovichа Koroleva: izbrannyye trudy i dokumenty* [Moscow: Nauka, 1980] pp. 405-08.

- Creation of a piloted satellite with return via gliding (1959-65)
- Research on opportunities for the exploration of Mars and Venus via automatic apparatus and returning to Earth's vicinity with photographic and other data (1959-61)
- Research on processes for bringing together two vehicles in orbit that would require preliminary scientific work (1962-66)

The second portion of the document addressed the development of new launch vehicles:

- Creation of a space booster with a payload of fifteen to twenty tons (ending in 1963 or 1964)
- Creation of ion and other engines for interplanetary flight and human flight to the Moon and nearest planets

In the third portion. Korolev and Tikhonravov addressed the use of the new launch vehicles enunciated above:

- Creation of a piloted satellite with one or two humans to develop conditions for extended piloted spaceflight and the establishment of satellite stations (1961-65)
- Creation of a spaceship using ion engines for piloted flight to the Moon and back to a station in Earth orbit (1961-65)
- Creation of automated spacecraft for investigations of Mars and Venus and their return to near-Earth space for research on the surface of the planets and testing long-distance radio communications (1963-66)
- Creation of "artificial settlements" in space with the following goals:
 - a. Creation of near-Earth stations. work starting in 1962, for:
 - (i) Studying prolonged weightlessness, artificial gravity, and effects on plants, humans, and animals
 - (ii) Studying the effects of radiation on vegetation and living organisms
 - b. Creation of near-Earth stations, work starting in 1962, for:
 - (i) Assembly of "interorbital" vehicles
 - (ii) Creation of a space transportation system with Earth
 - (iii) Reception of "interorbital" vehicles

After accomplishing these objectives, the following two goals would be within reach:

- Flight of humans to Mars and Venus
- Flight of humans to the Moon and their return to Earth
- Construction of a continuously operating "station colony" on the Moon, on which preliminary work would begin in 1960

The fourth and final part of the document discussed exploratory work that scientists would carry out as part of research and development programs:

- Research on rockets propelled by chemical and nuclear propellants for lofting large payloads to Earth orbit and to the Earth-orbital stations (1959-60)
- Research on ion, plasma, and similar types of engines for use on interorbital transport spacecraft (1959-60)
- Research on rendezvous in orbit leading to experimental verification (1958-61)
- Research on technologies for orbital assembly of a space station in Earth orbit, using rocket stages as components of the station (1959-63)

- Research on closed-cycle life support systems and spacesuits (1960–65)
- Development of energy sources for Earth orbital stations and interorbital apparatus (1958–62)
- Research on radio communications over very long distances (1959–65)

In conclusion, Korolev and Tikhonravov added that the listed dates were preliminary and that there would undoubtedly be many other fields of scientific-research work that would accompany the enumerated goals.

Several important thematic directions emerge from closer inspection of the document. By early 1959, some of the more immediate goals were already part of ongoing programs, in particular the automated lunar probes, the human spaceflight effort, and the military photo-reconnaissance program. As far as long-term objectives, Korolev and Tikhonravov clearly give a nod to Tsiolkovskiy's early theories, with a continued emphasis on Earth-orbital space stations acting as places of research as well as bases for the further exploration of space. In addition, in their vision of the future piloted exploration of the planets is one of the central objectives. This particular theme would in fact dominate much of the long term research at OKB-1 during the following five years as the Soviet space program was in the midst of expansion. It is noteworthy that for Korolev and Tikhonravov, who had been raised on a diet of Tsiolkovskiy and Tsander a piloted lunar landing was not deemed important enough for short-term consideration but instead was consigned to second place after interplanetary missions.

Unlike many of Korolev's earlier letters to the government there is nothing in the text in the document to suggest that the attainment of these goals would reap political dividends in a "space race" with the United States. The clear and well-thought out goals listed in the document were really the first concrete attempt by the designer faction to move ahead from isolated Sputniks and lunar probes to a rational and broad plan for the exploration of space.

Korolev and Tikhonravov signed the document and sent it to the Military-Industrial Commission on July 5, 1958. It is now clear that a number of key proposals in the report were discussed at a very high level over the course of the following year, although the specifics still remain classified. Superficial details are available of a meeting in Moscow in February 1959 to discuss nuclear propulsion for spacecraft, but the nature of debates on the larger issue of the conception and policy of a civilian and military Soviet space program still remain shrouded in mystery.⁵ What is apparent is that by the summer of 1959, one year after having sent their letter, there had not been a single decree on long-term goals from the Communist Party and government. This lack of response may have been a catalyst for more action on Korolev's part.

In the early summer of 1959, he put his resources together with Academician Keldysh, certainly much more influential and powerful than Tikhonravov, and fired off three documents in succession to the Soviet leadership. The first one, dated May 20, 1959, was a letter proposing the addition to current plans of a project for designing an "apparatus for returning from orbit and landing on the Earth." This was clearly in relation to the Object K program and referred primarily to the reconnaissance satellite with a few lines added on the piloted variant. Two days later, a decree was passed on both projects.

The second letter, sent only a week later on May 27, was much more comprehensive and exclusively addressed the immediacy of establishing formal institutional mechanisms for the new Soviet space program. The central proposition of the ten-point plan was to separate the ballistic missile effort from the space program:

⁵ The description of the 1959 meeting in Moscow can be found in A. P. Romanov and V. S. Gubarev *Konstruktory* (Moscow: Izdatelstvo politicheskoy literatury, 1989) pp. 308–10.

⁶ Yu. V. Biryukov, "Materials from the Biographical Chronicles of Sergey Pavlovich Korolev" (English title) in B. V. Raushenbakh, ed. *Iz istorii sovetskoy kosmonavtiki* (Moscow: Nauka, 1983) p. 241. The letter remains classified.

At the present time, operations associated with the exploration of space are being conducted mainly by the same organizations that have been developing long-range missiles. This is undoubtedly favorable for progress of these operations. But now, since the objectives and scope of space exploration earmarked for the nearest future have become extremely broad, it is the right time to invite new forces and new organizations.'

Specifically, the authors called for the creation of a Central Scientific-Research Institute for Interplanetary Research—a place where all future Soviet spacecraft would be designed. While Korolev's OKB-1 would retain the job of designing and building more powerful space launch boosters, the institute would be separate from the missile industry and focus exclusively on creating Earth-orbital satellites, piloted spaceships, and automated and piloted interplanetary vehicles. Korolev and Keldysh proposed that the new organization should be created on the basis of an existing aviation design bureau whose prior commitments would be transferred elsewhere.⁸ In the authors' vision:

This organization could become in the future a scientific center of space exploration on an international scale, bearing in mind that the Soviet Union has achieved the first useful results in the field. These results could be fruitfully developed and extended in the future in cooperation with the socialist countries."

As part of a general restructuring of the missile and space sector, Korolev and Keldysh also called for the creation of seven other specialized institutes for (1) guidance and control systems. (2) long-range space communications, (3) radio-telemetry systems. (4) the development of power supply systems (including nuclear sources). (5) the design and manufacture of scientific instruments for spacecraft. (6) biomedical research on humans and animals in space, and (7) planetary sciences.

In ending their appeal, Korolev and Keldysh called for the creation of a management and directing mechanism, the Interdepartmental Scientific-Technical Council of the USSR Academy of Sciences headed by Keldysh, which would oversee the entire Soviet space effort. The closest thing to such an entity in the United States was perhaps the extinct National Advisory Committee for Aeronautics, which had recently been succeeded and replaced by the National Aeronautics and Space Administration (NASA). Putting Keldysh's name as head of this proposed council would clearly work in Korolev's favor, given Keldysh's clout with the upper echelons and his favorable support for Korolev's plans. There is nothing in the document to suggest, however, that Korolev would relinquish his influence over any new institution dedicated to the development of space vehicles. This document from May 1959 can in fact be seen from one perspective as a means to consolidate Korolev's hold on the emerging space program. At the same time, it was also a plea for order and rational thinking—that is, to separate the missile and space industries and establish a number of institutions exclusively dedicated to space exploration.

Korolev sent a third letter, still classified, to the government on July 13 of the same year "on considerations for the organization of work" on the space program.¹⁰ The requests were important elements in the pursuit of establishing a separate space program in the Soviet Union.

7 The complete document with disguised designations has been reproduced as S. P. Korolev and M. V. Keldysh 'On the Development of Scientific Research and Experimental Design Work on the Mastery of Cosmic Space' (English title) in Keldysh ed. *Tvorcheskoye naslediyе Akademika* pp. 409-12.

8 The aviation design bureau is unnamed in the document but it was possibly OKB 256 headed by Chief Designer P. V. Tsybin who was an old associate of Korolev's from the late 1920s.

9 Korolev and Keldysh 'On the Development of Scientific Research' p. 411.

10 Biryukov "Materials from the Biographical Chronicles" p. 241.

and Korolev took advantage of his peaking influence and power to propose some bold ideas, such as international cooperation, certainly a sensitive subject given the space sector's origins in the ICBM program. He had the support of sympathetic figures in powerful positions, such as Khrushchev, Ustinov, Rudnev, and Keldysh, patronage strong enough to quickly facilitate the launch of the first Sputniks, a series of launches in an automated lunar exploration program, and to gain the approval for a piloted satellite project. But this small window of opportunity did not last long. By 1959, a variety of factors had begun to erode the power of the Council of Chief Designers to force through a vigorous space program. The immediate response from the leadership to the series of letters in 1957 through 1959 remains unclear. When the government did take action on the space program, it ultimately fell far short of what Korolev and his associates desired.

On December 10, 1959, the Central Committee and the USSR Council of Ministers issued the very first decree, number 1386-618, on a macro-level policy on the Soviet space program.¹¹ Titled "On the Development of Research Into Cosmic Space," the decree was a modest first step in elaborating goals for the Soviet space program, albeit one with short-term goals. Evidently, only one of the May 1959 recommendations for institutional change proposed by Korolev and Keldysh was addressed in the decree: the document sanctioned the formation of the Interdepartmental Scientific-Technical Council for Space Research, an advisory body under the aegis of the Academy of Sciences to oversee thematic and project proposals on long-range space goals. Council members included senior officials from the design bureaus, institutes, scientific community, and military. Two designers from OKB-1—Korolev and his "space" deputy, Bushuyev—officially became members of the council's Presidium on January 13, 1960.¹²

The formation of the council, however, did not satisfy Korolev and Keldysh's call for an industry-wide reorganization. Perhaps armaments people Ustinov and Rudnev found Korolev's proposal to establish an organization in the aviation industry an anathema to their allegiances. The authors of the decree did, however, mention some of the points in the earlier July 1958 letter of Tikhonravov and Korolev. The government granted approval for the development of a four-stage variant of the R-7 for a series of automated missions to Mars, Venus, and the Moon, for piloted missions in the Object K spacecraft, and for exploratory studies on a heavy-lift booster.¹³ The Ministry of Defense, the primary funding conduit for the design bureau system, was simply not interested in supporting a flourishing and long-range space program as outlined in the numerous letters to the leadership in the preceding two years. This clash over defense priorities was a theme that would grow much larger throughout the 1960s, but in 1959, it was the first indication to Korolev and the remaining members of the Council of Chief Designers that an indigenous space program was going to have a painful birth. What little funding was extracted would have to be continually justified on the basis of defensive needs, certainly a tricky proposition when one considers Korolev's ultimate goals of large space stations in Earth orbit servicing piloted interplanetary missions to Mars and Venus.

Within the defense sector, during the latter part of the decade, there had been a noticeable shift in Soviet strategy shifting from dependence on long-range aviation to ICBMs. This major

11 Raushenbakh ed *Materialy po istorii* p 210 G Vetrov 'The Difficult Fate of the NI Rocket' (English title) *Nauka i zhizn* no 4 (April 1994) 78-80 K Lantratov 'Russia to Mars!' (English title) *Novosti kosmonavtiki* 20 (September 23-October 6 1996) 53-72 Georgiy Stepanovich Vetrov 'Development of Heavy Launch Vehicles in the USSR' presented at the 10th International Symposium on the History of Astronautics and Aeronautics Moscow State University Moscow Russia June 20-27 1995

12 B V Raushenbakh ed *S P Korolev i ego delo* suet i teni v istorii kosmonavtiki izbrannyye trudy i dokumenty (Moscow Nauka 1998) pp 675-76

13 Vetrov 'Development of Heavy Launch Vehicles' B Ye Chertok *Rakety i lyudi Fili Podlipki Tyuratam* (Moscow Mashinostroyeniye 1996) p 425 Lantratov 'Russia to Mars!'

shift, along with the advent of the R-7 ICBM and less powerful missiles from the Yangel design bureau, such as the R-12 and the R-14, necessitated a revamping of the existing command structure in the procurement and operation of ballistic missiles. Throughout the 1950s, the Ministry of Defense's control and influence over ballistic missile development was effected through its subordinate Chief Artillery Directorate in a department called the Directorate of the Commander of Reactive Armaments. Early proposals from various factions in the summer of 1959 addressed the anachronistic nature of having new generations of ballistic missiles in the control of artillery forces. Khrushchev elected not to follow the example set by the United States, where the U.S. Air Force controlled strategic missiles. Despite some significant opposition from within the Ministry of Defense, Khrushchev pushed through the formation of a new branch of the Soviet armed forces, the Missile Forces of Strategic Designation (RVSN), more commonly known as the Strategic Missile Forces. Signed into existence by a decree of the Communist Party and government on December 17, 1959, the Strategic Missile Forces inherited the control of all ballistic missiles in the Soviet Union.¹⁴

Marshal Nedelin, the fifty-seven-year-old military technocrat behind the successful missile buildup in the Soviet Union in the 1950s, was appointed the first Commander in Chief of the new service. Nedelin knew Korolev well. The latter regarded Nedelin very highly and was reported to have said that when it came to issues of quality control and delivery dates, Nedelin was a very principled and demanding customer." All activities carried out by the Chief Artillery Directorate that were related to long-range missiles were transferred to the Strategic Missile Forces; by default, the Directorate of the Commander of Reactive Armaments also became a portion of the new Forces, thus bringing with it all its duties on operating space launch vehicles. Confusingly renamed the Chief Directorate of Reactive Armaments (GURVO), this growing department continued to handle all launch, tracking, and communications operations for Soviet spacecraft under the tutelage of its chief, Lt. General Anatoliy I. Semenov.¹⁶

This unprecedented degree of control over the Soviet space program consolidated the position of the Ministry of Defense to affect space policy for decades to come. In the late 1950s and early 1960s, liaison with the space program was handled neither by Nedelin nor Semenov, but by two other officers in GURVO, both of whom would go on to play significant roles in policy formation and execution in the space program: Lt. General Aleksandr G. Mrykin and



Marshal Mitrofan Nedelin was the first commander of the Soviet Strategic Missile Forces. Through a long and distinguished career in the 1940s and 1950s, he had served in various capacities overseeing the procurement of the first long range ballistic missiles into the Soviet armed forces. (files of Peter Corin)

¹⁴ The decrees on the formation of the RVSN are reproduced in I. D. Sergeev, ed., *Khronika osnovnykh sobyitiy istorii raketnykh voysk strategicheskogo naznacheniya* (Moscow: TsIPK, 1994), pp. 236-39. The Central Committee decree number was "Protocol No. 254," while the Council of Ministers decree number was 1384.615.

¹⁵ V. Tolubko, *Nedelin* (Moscow: Molodaya gvardiya, 1979), p. 176.

¹⁶ Sergeev, ed., *Khronika osnovnykh sobyitiy istorii*, p. 8. Yu. A. Mozzhorin et al., eds., *Dorogi v kosmos II* (Moscow: MAI, 1992), p. 117.

Maj. General Kerim A. Kerimov. The former was the First Deputy Commander of GURVO, while the latter was the head of GURVO's new Third Directorate, specially tasked to handle "client" operations related to launch vehicles, satellites, ground equipment, and command and control on behalf of the Strategic Missile Forces. This Third Directorate, created in September 1960, was the seed of the Russian Military Space Forces of the 1990s.¹⁷ Mrykin, a man with a larger-than-life personality rivaling Korolev himself, was legendary for his hard-headed nature and inflammatory short temper—traits that terrified most officials who came into contact with him. He did, however, have close relationships with the members of the Council of Chief Designers, facilitating a relatively efficient mode of communication between the space and missile sectors.

What was remarkable about all four men—Nedelin, Semenov, Mrykin, and Kerimov—was that all had been involved in missile programs as artillery officers, starting with visits to Germany in 1945 during the famous operation to study the A-4. The stranglehold of these artillery veterans on the new Soviet space program was not transitory: artillery troops, later subsumed by the Strategic Missile Forces, launched every single Soviet missile and spacecraft, beginning with the first A-4 launches from Kapustin Yar in 1947 up to the end of 1991, when the USSR as an entity was formally dissolved. The ubiquity of the artillery men in the space program was not limited to the Strategic Missile Forces. In 1959, artillery veterans of the 1945 German visit headed several important institutes in the industry, including NII-4 and NII-88.¹⁸ In the following years, they would also find positions in design bureaus and bureaucratic positions in ministries. This powerful lobby would pose a significant threat to Korolev's ideas of a grand space program.

Korolev in Trouble?

The conflict over defense spending was not the only threat to Korolev's plans. In 1958 and 1959, four different issues emerged in the discourse over the development of ballistic missiles, all of which involved Korolev. Although seemingly peripheral to the Soviet space program, the effects of these four factors were far reaching: together, they had an unprecedented cumulative effect on the course of human space exploration programs in the Soviet Union in the 1960s.

The primary competitor to Korolev's OKB-1 in the field of ballistic missiles was OKB-586 headed by Chief Designer Mikhail K. Yangel. In 1954, Yangel had inherited Korolev's efforts with storable propellants, turning a modest program into a full-fledged competitor to Korolev's own design bureau. Yangel's organization had rapidly developed the R-12 medium-range ballistic missile, which was formally declared operational on March 4, 1959.¹⁹ Encouraged by the success of Yangel's first missile, the development of a second more powerful missile, the R-14, with a range of 4,500 kilometers, had been approved by the USSR Council of Ministers on July 2, 1958.²⁰ Both the R-12 and R-14 missiles used high-boiling storable components as

¹⁷ Yu P Maksimov ed *Raketnyye voyska strategicheskogo naznacheniya voyenno-istoricheskii trud* (Moscow RVSN 1992) p 49 For a mention of the Third Directorate see B Ye Chertok *Rokety i lyudi goryachyie dni kholodnoy voyny* (Moscow Mashinostroyeniye 1997) p 154 See also V V Favorskiy and I V Meshcheryakov eds *Voyenno kosmicheskiye sily (voenno istoricheskii trud) kniga I kosmonautika i uoruzhennyye sily* (Moscow Sankt Peterburgskoy tipografii no 1 VO Nauka 1997) pp 56–57 According to Kerimov he headed 'the directorate which handled the monitoring of the planning and manufacturing of space rockets and craft for flight in the automatic operation versions' See K Israkov 'Breakthrough into the Unknown Today is Cosmonautics Day' (English title) *Bakinskiy rabochiy* April 12 1988 p 3

¹⁸ By late 1959 NII 4 was headed by Maj General A I Sokolov and NII 88 by Maj General G A Tyulin both artillery officers

¹⁹ Sergeev ed *Khronika osnovnykh sobytii istorii* p 36 The first silo launch of the R 12 took place on August 31 1959

²⁰ V Pappo Korystin V Platonov and V Pashchenko *Dneprovskiy raketnokosmicheskiy tsentr* (Dnepropetrovsk PO YuMZ/KBYu 1994) p 61

propellants, which had two major advantages over low-temperature cryogenic propellants such as liquid oxygen (LOX): they allowed missiles to be kept battle ready for long periods, and they permitted very quick preparations for launch. They also had some drawbacks; they were usually extremely toxic, dangerous to handle, and corrosive to traditional propellant tanks. Historically, Korolev had always preferred cryogenic combinations, primarily because they offered high specific impulse ratings and lifting efficiency, important factors for space launch boosters but much less relevant for military missiles. The first Soviet ICBM, the R-7, used a LOX-kerosene combination, a relatively efficient combination for space launch operations, but a poor choice for battle-ready missiles. In the best case, the R-7s took eight to ten hours to fuel and too much effort to keep ready. If a launch were canceled, a missile had to be emptied at the pad within ten hours, a dangerous situation for a rocket designed to be the first element of a Soviet strategic missile force. As early as August 1956, the all-powerful Council of Defense of the Politburo had adopted a decision to accelerate work on ICBMs that did not use cryogenic propellants."

Concerns about propellants were compounded by the steep costs of building launch pads for the bulky R-7. Originally, the Ministry of Defense had proposed approximately fifty pads all over the Soviet Union, but the astronomical costs of such an endeavor quickly squelched any such plans. The R-7 itself went through a troublesome test regime. The first series began on May 15, 1957, and ended on July 10, 1958. Engineers incorporated improvements to the ICBM over the following year and conducted a second series of eight launches between December 24, 1958, and December 27, 1959.²¹ Problems with the R-7 were slowly eliminated during these intensive tests, and the missile was officially declared an operational element of the Soviet armed forces on January 20, 1960. An improved version, the R-7A, with a lighter warhead and an all-inertial guidance system, became the standard version once it was declared operational in September of the same year." Although it was the world's first ICBM, the R-7A was at best a very poor element of the strategic rocket forces. The costs of building launch pads, their visibility to overflying reconnaissance, the inordinate time to fuel the rocket, the use of cryogenic propellants, and the poor accuracy of the warhead were all reasons that prompted Khrushchev to drastically reduce plans to deploy the missile in large numbers. In the end, a total of four launch complexes were built, three of which were used as sites by strategic forces and the fourth for space launches."

21 The Council of Defense meeting may have been in response to a proposal from Chief Designer V. P. Glushko on a new ICBM, the R-8, which would have used storable propellants instead of cryogenic pairings. Korolev was informed of the Council of Defense decision on October 16, 1956, by Marshall M. I. Nedelin. See Raushenbakh, ed., *S. P. Korolev i ego delo*, pp. 251, 664-65.

22 Yu. A. Mozzhorin et al., eds., *Nachalo kosmicheskoy ery vospominaniya ueteranov raketno kosmicheskoy tekhniki i kosmonavtiki uypusk vtoroy* (Moscow: RNITSKD, 1994), p. 59. Of the eight launches during the second series, seven were successful. The first series-produced R-7 was launched on February 17, 1959, while the first fully fueled, operational R-7 was launched to the Pacific Ocean on October 22, 1959. See Biryukov, "Materials from the Biographical Chronicles," pp. 241-42.

23 Sergeyev, ed., *Khronika osnovnykh sobytii istorii*, p. 37. The R-7A had a range of 12,000 kilometers. Authorization for the project was granted on July 2, 1958; the first launch was on December 23, 1959, and flight testing ended on July 7, 1960. See Maksimov, ed., *Raketnyye uoyuska strategicheskogo*, p. 47.

24 Of the four pads, two were at the Scientific Research Testing Range No. 5 (NIIP 5) at Tyura Tam at sites 1 and 31. Site 1 was for the early space launches. Construction of the latter was completed in late 1958, along with its own integration building at site 32. The remaining two pads were at a new site in northern Russia near the town of Mirnyy at NIIP 53. Officially called the Object Angara, the base was the site of two pads, the first of which was finished in 1959 (site 16) and the second of which was finished in 1961 (site 41). It was these two latter pads that constituted the main battle-ready R-7 pads. The first pad went on an alert status on December 15, 1959, a month prior to the order declaring the R-7 operational. See also Ye. B. Volkov, ed., *Mezhkontinentalnyye ballisticheskiye rakety SSSR (RF) i SShA* (Moscow: RVSNI, 1996), p. 269.

The disappointment with the R-7 was a major blow to the limitless faith Khrushchev had placed on Korolev's abilities. It was the first of a number of factors that began to adversely affect the "open line" between the two, that had facilitated many of Korolev's early space plans. In May 1958, Khrushchev, at one of his many meetings with Korolev, had asked the chief designer about the possibility of finding a more efficient solution to the ICBM problem than the R-7. To Khrushchev's queries on storable propellants such as nitrogen tetroxide, Korolev merely replied that it would be impossible to build an ICBM using such components, invoking the difficulty of developing powerful engines using toxic components. Korolev's total insistence at using cryogenic propellants, no doubt stemming from his visions of space exploration prompted him to propose a replacement for the R-7 a new missile called the R-9. Cryogenic propellants would still fuel the missile, Korolev promised to use high-speed pumps for quick preparations during battle, as well as super-cooled LOX to extend the time it could be maintained at flight readiness. In addition, the R-9 would only be half the mass of the cumbersome R-7. Khrushchev promised to think about the proposal but in general remained unsatisfied with Korolev. The Soviet leader confided in his son that Korolev appeared to be keener on achieving space records than work on defense.

The day after the meeting with Korolev Khrushchev called in Glushko. The latter was a strong believer in storable propellants, and Glushko had had problems with LOX for years. Beginning with his early work in 1930s, Glushko had consistently preferred storable propellants such as nitric acid, shying away from the vibration and combustion problems associated with more sophisticated cryogenic designs. Glushko told Khrushchev that an ICBM on storable propellants was possible to build and recommended Yangel as a potential contractor. He was particularly interested in a new combination of red fuming nitric acid and unsymmetrical dimethyl hydrazine, which would offer a potentially easy fix to the missile storage problems. Khrushchev took advantage of the advice and met with Yangel soon after. The latter, while conceding that using toxic propellants would be difficult, was completely amenable to the idea. The notion of creating an ICBM at OKB-586 had been one of Yangel's ultimate goals for some time. After the Council of Defense recommendation on building noncryogenic ICBMs, on December 17, 1956, the USSR Council of Ministers approved exploratory work on a new missile at Yangel's organization, called the R-16. Yangel received encouragement on his work when an independent panel approved the paper design of the missile in January 1958."

Khrushchev's meeting with Yangel may have been pivotal in shifting "patronage" away from Korolev. Perhaps to be completely sure of any future action, he met with Korolev once again to hear his views on the propellant debate. Once again, Korolev repeated his views on what he considered "the devil's venom." Hearing that Khrushchev was considering giving Yangel the contract for a new ICBM with storable propellants, Korolev made an uncharacteristic offer. As Khrushchev later remembered, Korolev told him:

25 Sergey Khrushchev *Nikita Khrushchev krizisy i raketny vzglyad iznutri tom 1* (Moscow: Novosti 1994) pp. 382-83. Note that there are contradictory reports that Korolev first proposed the R-9 ICBM idea to Khrushchev in September 1958. See Chertok *Rakety i lyudi goryachiye dni kholodnoy voyny* p. 23.

26 Pappo-Korystin Platonov and Pashchenko *Dneprovskiy raketno kosmicheskii tsentr* p. 61. The Council of Ministers decree in December 1956 approved the development of the R-16 ICBM for a first launch by June 1961. Work on the theoretical aspects did not, however, begin until November 1957, after the initial series of R-7 launches. The draft plan for the missile was approved in January 1958, but clearly there was some unexplainable delay in the program.

I propose that you give this acid-fueled [that is. storable propellant] missile project to me. Besides that. I will also make an oxygen-fueled missile that will be capable of nearly instantaneous action. This missile will not require any supplementary equipment, like those guidance stations that have to be located every five hundred kilometers along the missile's flight path."

Khrushchev was resistant to such an idea, but Korolev was insistent. Finally, the Soviet leader cut Korolev off sharply, reminding him that he was dealing with the Chairman of the USSR Council of Ministers. The meeting apparently had a profound effect on the relationship between Korolev and Khrushchev, as their previous rapport gradually began to cool. Korolev had to increasingly resort to normal institutional mechanisms to get his big space plans approved instead of taking them personally to Khrushchev. Thus he became more constrained by the wishes of Ustinov, Brezhnev, Nedelin, and others whose primary concern was defense, not space. Perhaps the only asset Korolev had on his side at the time was Khrushchev's interest in using the space program as a means to advance his prestige and power. This, of course, put Korolev in the difficult position of having to justify his projects not only in terms of their military utility, but also their appeal to the imagination of the people of the world.

There was a more *damaging* secondary effect. Some have speculated that when Korolev heard that Glushko had decided to cooperate with Yangel on the new R-16 ICBM, it was a move that Korolev could neither forgive nor forget. While Glushko had developed engines for Yangel's modest R-12 and R-14 missiles, his support and involvement in a new competitive ICBM project of Yangel was apparently unforgivable. Glushko, having been in Korolev's shadow for decades, had been longing for independence and a way out from the series of troubling LOX engines he had been developing in difficulty for Korolev. It has been suggested that it was also perhaps jealousy that drove Glushko to switch sides to Yangel—jealousy at Korolev's unprecedented rise in twenty years, from GULag prisoner to preeminent space designer. It was Glushko, after all, who had written to Tsiolkovskiy as a young child and who had dreamed of space exploration when Korolev was still flying gliders at the local pilots club back in the Ukraine.²⁸

The break between Korolev and Glushko was neither sudden nor permanent, at least not during the R-9 discussions. The first cracks had begun to appear as early as 1954, during design work for the R-7, when Glushko had refused to design verniers for the missile. The acrimony broke into open conflict in the summer of 1957 during the series of R-7 launches, when there had been much finger-pointing about the causes of the failures. In one of his letters to his wife back in Moscow during that summer, Korolev provided a window into the relationship between the two giants of the Soviet space program:

[Glushko] arrived today and to everyone's amazement (mine included!), using the dirtiest language and the crudest phrases, began telling us all that our work was utterly worthless—and this, just half an hour after he arrived. This created a terrible impression on everyone. . . . His tirade, unfortunately, could not be considered criticism, certainly not friendly *criticism*, but simply mindless malice. I answered him calmly (you can imagine the nerves that that cost me!) and only criticized him for his intemperance and arrogance. [Pilyugin] demanded that we sit down and analyze his behavior, but is that really possible? If a person behaves in such a way but considers his own opinions "more intelligent than anyone else's in all issues without exception," then the only way that you can fight is with facts which refute all that he had blurted out.."

27. Nikita S. Khrushchev, *Khrushchev Remembers: The Glasnost Tapes* (Boston: Little & Brown, 1990), p. 185. Author's emphasis.

28. For this line of interpretation, see Khrushchev, *Nikita Khrushchev*, pp. 382–83.

29. Yaroslav Colovanov, *Korolev fakty i mify* (Moscow: Nauka, 1994), p. 708.

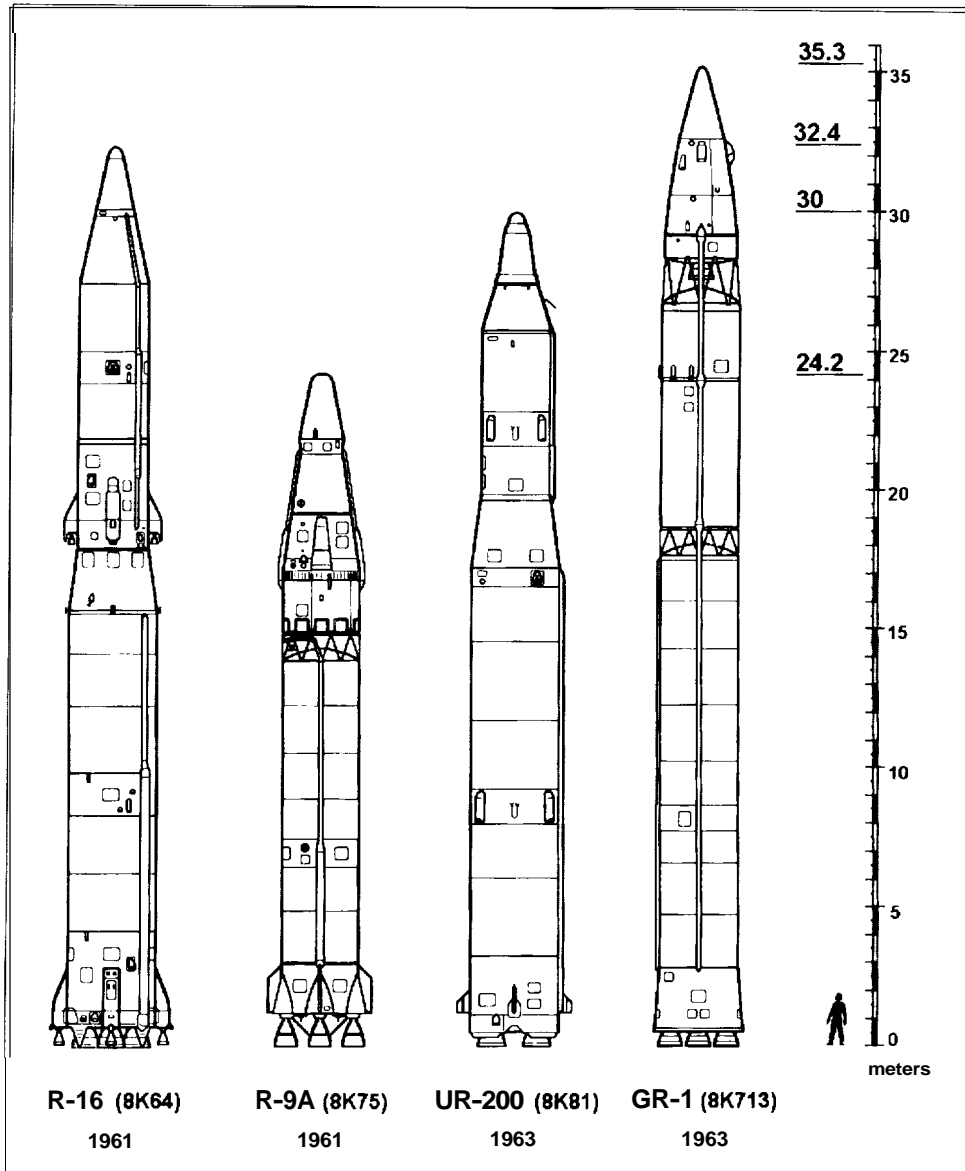

The evolution of long-range ballistic missile development in the Soviet Union in the post-Sputnik era. From the left are Yangel's R-16 (operational in 1961), Korolev's R-9A (1965), Chelomey UR-200 (canceled) and Korolev's GR-1 (canceled) (copyright Peter Gorin)

With their unusually headstrong characters, their innate ambitions, and, perhaps most importantly, their differences over technical matters, it is not surprising that the two found themselves in serious conflict. The maturation of the missile and space programs finally broke whatever semblance of friendship they had developed over the years.

Yangel's R-16 ICBM project was officially approved by an official governmental decree on August 28, 1958. It would be a two-stage intercontinental missile with both stages using

CHALLENGE TO APOLLO

engines from Glushko's OKB-456, fueled by storable propellants.³⁰ The road to approving work on Korolev's R-9 was fraught with more difficulty. In April 1958, under severe pressure from Korolev, the six original members of the Council of Chief Designers, including Glushko, sent an official letter to the Military-Industrial Commission with a proposal to initiate the formal development of Korolev's missile.³¹ Both Korolev and Glushko had motivations to cooperate on the new program—Korolev because Glushko essentially monopolized the development of high-thrust rocket engines in the Soviet Union, and Glushko because he was fearful of being excluded from a contract for a new ICBM project. By December of the same year, the two chief designers had agreed on the specifications for the two-stage missile.³² Within weeks, Korolev was having second thoughts on Glushko's involvement. On March 7, 1959 he sent another letter to Ustinov and Rudnev proposing the development of two variants of the ICBM—one with Glushko's engines, called the R-9A, and one with nitric acid-kerosene engines designed by Isayev's OKB-2, called the R-9V. The latter option emerged for two reasons: it would be Korolev's stab at making a storable propellant rocket, and it would be insurance against Glushko's failure to develop a cryogenic engine.³³ The Soviet government declined to allocate resources for two versions of the rocket and, on May 13, 1959, issued an official decree approving R-9 development with only Glushko's engines.³⁴ The eighty-one-ton missile was to carry a two-ton warhead a full distance of 12,500 kilometers. Many of the performance characteristics of the R-9 were quite similar to the Martin Marietta Titan I ICBM, whose very existence was used by Korolev as justification for the R-9.

The program proved to be a Pandora's box of problems for Korolev. Put on the defensive by the military, Korolev had to continually defend his creation to a less than enthusiastic client, whose officials were quickly losing any interest in cryogenic ICBMs. OKB-1 First Deputy Chief Designer Mishin, who was the originator of the R-9 proposal, was instrumental in propping up Korolev's vehement opposition to storable propellants and enumerating the advantages of LOX. Mishin persistently supported LOX-based combinations and argued that given the resources, he could draw up technical plans to overcome the apparent deficiencies of LOX in the eyes of the military. He emerged with some remarkable technical solutions, including low-cost storage systems and high-speed pumps, which may have saved the R-9 program.³⁵

Glushko, meanwhile, ran into severe problems with his chosen engines. The R-9 first stage required an engine with a thrust of about 140 tons at sea level. This high thrust level was, however, far in excess of any engine he had ever produced in his thirty years as an engine

30 Pappo-Korystin, Platonov, and Pashchenko. *Dneprouskiy raketno-kosmicheskii tsentr*, p. 62. The engines were the RD-218 for the first stage and the RD-219 for the second stage. The propellants were unsymmetrical dimethyl hydrazine and red fuming nitric acid for both engines. Some sources state that government approval for the R-16 was granted on May 13, 1959—that is, in the same decree approving Korolev's R-9 missile. See, for example, Golovanov, *Korolev* p. 709.

31. This document, dated April 18, 1958, has been published in abridged form as "On Prospective Developments of Oxygen Missiles." in Raushenbakh, ed., *S. P. Korolev i ego delo*, pp. 249–51.

32. Glushko sent Korolev clarifications on performance ratings for his first-stage engines on December 9, 1958. Korolev sent a subsequent letter to the government and other chief designers on December 19. In it, he proposed a launch mass of seventy to seventy-five tons and a range of 12,000 kilometers for the mobile missile. See Raushenbakh, ed., *S. P. Korolev i ego delo*, p. 671. Note that Glushko had also proposed a variant of the R-9, known as the R-9B, using storable propellants (nitric acid-unsymmetrical dimethyl hydrazine), but Korolev apparently never took the idea very seriously.

33. Confusingly, Korolev also invited Yangel to participate in R-9V development. The R-9V would use four of OKB-2's engines of forty tons thrust each on the first stage. Yangel's OKB-586 would have responsibility for the general layout of the missile. See *ibid.*, pp. 595, 672.

34. I. Afanasyev, "The Mysterious 'Nine'" (English title), *Aviatsiya i kosmonautika* no. 8 (August 1992) 34–35.

35. For a summary of Mishin's role in the R-9 LOX debate, see Chertok, *Rakety i lyudi*. F. I. Podiipki Tyurafam, p. 217. Chertok, *Rakety i lyudi. goryachye dni kholodnoy voyny*, pp. 27–28; James Harford, *Korolev: How One Man Masterminded the Soviet Drive to Beat America to the Moon* (New York: John Wiley & Sons, 1997), pp. 114–19.

designer. An attempt to build a similar single-chamber engine in the early 1950s had ended in complete failure. The new engine, the RD-111, also ran into serious problems. Like the R-7 engines, the new engine comprised four combustion chambers fed by the same turbopump. Unlike the earlier engines, however, the RD-111 had much higher chamber pressures (eighty versus sixty atmospheres), which, as it turned out, was the primary cause of high-frequency self-stimulated vibrations that tore the engines apart during ground tests.³⁶ Anticipating precisely such a situation, Korolev, with the approval of some key members in the government, had invited a new engine design organization to usurp Glushko's monopoly in the Soviet missile program: OKB-276, headed by forty-seven-year-old designer Nikolay Dmitriyevich Kuznetsov. Perhaps the most famous aviation engine designer of the era, Kuznetsov started his career in 1943 when he joined the Klimov Design Bureau as a Deputy Chief Designer, working on engines for Yakovlev and Petlyakov's fighter aircraft. On April 17, 1946, the Soviet aviation industry established a new design bureau at Plant No. 2 at Kuybyshev, to develop new turbojet engines for postwar airplanes. Three years later, Kuznetsov, then only thirty-eight years old, was appointed its Chief Designer. His organization went from strength to strength, making engines for some of the most famous Soviet airplanes of the 1950s, including the strategic Tu-95 bomber and the Tu-114 passenger aircraft."

Unlike some other aviation chief designers, Kuznetsov was not the slightest bit interested in either the missile or the space industry. He had a well-established reputation as a designer of high-performance jet engines for Tupolev, Ilyushin, and Antonov, and he was not willing to jeopardize his standing by partaking in a high-risk endeavor in which he had no experience. But in the end, he was a victim of circumstance. By the late 1950s, the aviation sector as a whole was hit by hard times. As Khrushchev shifted his military strategy from aviation to missiles, numerous design enterprises found themselves without contracts to survive. In effect, the Soviet leader forced many of these organizations to make a radical shift in their design profiles. Kuznetsov was so resistant to shift his design bureau to the missile and space industry that he took the matter to Froil R. Kozlov, who was chairman of the Council of Ministers of the Russian Soviet Federated Socialist Republic. Kozlov and Kuznetsov enlisted the aid of Nikolay K. Kirichenko, possibly the most powerful man in the country after Khrushchev. However, the Soviet leader was not interested in Kuznetsov's arguments; he would have to shift to the rocketry industry, and that was it."

Kuznetsov played right into Korolev's dilemma over the R-9 program. In November 1959, Korolev, alarmed by the delays in Glushko's engine development program, wrote to Secretary of the Central Committee Leonid Brezhnev, the nominal head of the Soviet space and missile program." His request was unambiguous; first, he wanted Glushko ejected from the R-9

36 Chertok *Rakety i lyudi goryachiye dni kholodnoy uoyny* p 33

37 A. N. Ponomarev *Sovetskiye aviatsionnyye konstruktory* (Moscow: Voennoye izdatelstvo, 1990) pp 292-95. Kuznetsov was a Deputy Chief Designer at the V. Ya. Klimov Design Bureau (OKB 26) from 1943 to 1946 and a Chief Designer at the same organization from 1946 to 1949. He was appointed to his post as Plant No. 2 Chief Designer in 1949. See G. P. Svishchev, ed., *Aviatsiya entsiklopediya* (Moscow: Bolshaya Rossiyskaya entsiklopediya, 1994) p 299. In June 1953, Plant No. 2 was renamed Plant No. 276, at which time the design bureau was named OKB 276.

38 Golovanov *Korolev* pp 713-14. Korolev had been acquainted with Kuznetsov since about 1956-57, when the latter had begun exploratory work on rocket engines as part of the general redirection of work at the firm. See Igor Afanasyev, "N. S. Korolev: Absolutely Secret" (English title), *Krylia rodiny* no. 9 (September 1993), 13-16. Kuznetsov's early work on rocket engines had been in cooperation with OKB 165 of Chief Designer A. M. Lyulka, another aviation engine enterprise which had redirected its efforts to developing rocket engines for the ballistic missile and space programs.

39 This letter, dated November 25, 1959, has been reproduced in full as S. P. Korolev, "Letter to L. I. Brezhnev on Reorganization of Work on ZhRDs" (English title), in Raushenbakh, ed., *S. P. Korolev i ego delo*, pp 284-85. By October 14, 1959, Korolev and Kuznetsov had finished a draft plan for the new variant of the R-9, designated the R-9M. The four NK-9 first stage engines were from Kuznetsov's OKB 276, while second stage engines would be from Isayev's OKB 2.

program. and second, he wanted to proceed using newcomer Kuznetsov's engines. Ustinov, the chairman of the Military-Industrial Commission, took a different view and supported Glushko's participation. Although Ustinov had for the most part been Korolev's supporter throughout the 1940s and 1950s, he was not, by any means, a blind ally of the latter. Ustinov's primary allegiance was to the military-industrial complex, not to any particular designer, and in 1959, Korolev's star in the missile industry was no longer rising. Under "strong pressure" from Glushko, Ustinov sided against Korolev: the latter would have to continue with Glushko's trouble-prone RD-111 engine. Although ground tests for Kuznetsov's engines continued for some time, this R-9 variant was never developed. Glushko, at least for the time being, maintained his monopoly over the design of high-thrust rocket engines in the Soviet Union.⁴⁰

The R-9/R-16 debacle in 1958 and 1959 brought four major issues to the forefront of the Soviet space program. The first was Khrushchev's loss of faith in Korolev as the best rocket builder in the Soviet Union; Yangel had taken that place. The second was Korolev and Mishin's full-fledged support of cryogenic propellants over storable propellants for both ICBMs and space launch vehicles. The third was the split between Glushko and Korolev over propellant selection. The fourth was the entrance of the Kuznetsov organization into the fray as a possible alternative to Glushko's monopoly in high-thrust rocket engine development. These four factors set the stage for the catastrophic dissension among the leading designers of the Soviet space program during the 1960s. In 1959, of course, the cumulative consequences of these factors could not be known. Korolev was at the peak of his influence. He had a strong support system within the Communist Party, the government, the military, and the Academy of Sciences. And he was building the first Soviet spaceship designed to carry humans into orbit. But as Korolev's monopoly in the missile business began to erode, his leading role in the piloted space program was also challenged in the late 1950s by three additional organizations led by prominent aeronautical engineers. All of these chief designers were "outsiders" from the aviation industry, and they entered the fray without a history in the armaments sector like Korolev. One of these men would compete fiercely with Korolev for the next decade.



Nikolay Kuznetsov was the aviation designer based in Kuybyshev who joined forces with Sergey Korolev in 1958 to begin research on high-thrust cryogenic rocket engines for ICBMs. In later years, Kuznetsov would play a critical role in designing engines for the N1, the Soviet Moon rocket (files of Peter Gorin)

⁴⁰ Afanasyev, "The Mysterious 'Nine'": Semenov, ed., *Raketno-Kosmicheskaya Korporatsiya*, pp. 121-23; Harford, Korolev, p. 114. As early as January 18, 1960, State Committee for Defense Technology Chairman K. N. Rudnev sent a letter to Korolev (with a copy to D. F. Ustinov) ordering Korolev to proceed only with the Glushko variant of the R-9.

The Spaceplanes

Most histories of the early Soviet space program mention one human-in-space project from the late 1950s and early 1960s, the Vostok program, which paralleled NASA's Project Mercury. Declassifications in the early 1990s clearly show that Vostok was only one side of a much larger effort in human spaceflight. As in the United States, military piloted space proposals had also interested the Soviet government by the late 1950s. During this time, the aviation industry in the Soviet Union was facing its most severe challenge. A recent convert to the effectiveness of missiles, Khrushchev pushed through a number of reforms from 1957 to 1960, which effectively curtailed contracts for the majority of aviation design bureaus in the Soviet Union. Some organizations were even dissolved, and engineers were forced to look for work elsewhere. Having made the decision in 1946 not to engage in missile design, the leaders of the State Committee for Aviation Technology faced the consequences of their actions a decade later." To sustain the well-being of their design bureaus, a number of chief designers from the aviation industry were forced to offer proposals related to missiles. Kuznetsov's OKB-276 and Kosberg's OKB-154, for example, joined with Korolev to work on his missiles and space launch vehicles. The Soviet Air Force, cognizant of the state of its reduced funding, also shifted its priorities to space issues at the time. A rare public showing of the Air Force's interest in such vehicles was illustrated in an article in its own daily newspaper, published soon after the launch of the first two Sputniks. The author, a V. Aleksandrov, described a "rocket-plane" capable of suborbital flights at speeds of 15,000 kilometers per hour and altitudes of 200 kilometers." At the same time, a secret Air Force panel in late 1958 examined the primary thematic directions it should take during the following twenty-five years. Among other things, their report recommended two areas of further research:

- An early stage with aircraft flying at 6,000 to 7,000 kilometers per hour and altitudes of eighty to 100 kilometers for research into aerodynamic heating and flight dynamics at high speeds and altitudes
- A later stage with velocity and altitude increased to more than Mach 10 and 100 to 150 kilometers, respectively."

In its interest in spaceplanes, the Soviet Air Force also had help from the U.S. Air Force. The latter had been conducting studies on hypersonic vehicles for almost a decade, and a formal program, the Dyna-Soar project, was approved on October 10, 1957, less than a week after the launch of Sputnik. A three-step program was outlined, leading to the deployment of an orbital weapons system.⁴⁴ The progress in the Dyna-Soar program may have been the final catalyst for similar projects in the Soviet Union, the first of which was undertaken under fifty-two-year-old Pavel Vladimirovich Tsybin, an aeronautical engineer who had designed gliders in the late 1920s with Korolev. In the late 1940s, Tsybin had designed several high-speed "flying laboratories" that were powered by solid-propellant rocket engines. Based on this experience, on

41 For a summary of the aviation versus rocketry debate in the Soviet government in the late 1950s see Khrushchev *Nikita Khrushchev* pp 292-94

42 V Aleksandrov "Rocket Plane the Aircraft of the Future (English title) *Souetskaya aviatsiya* December 1 1957 An English translation of the article can be found in *Soviet Writings on Earth Satellites and Space Travel* (Freeport NY Books for Libraries Press 1958) pp 196-99

43 V M Petrakov 'Two Projects of V M Myasishchev ' *Journal of the British Interplanetary Society* 47 (September 1994) 347-54

44 For a detailed exposition on the events leading to the decision on the Dyna Soar program see Roy F Houchin II 'Why the Air Force Proposed the Dyna Soar X 20 Program ' *Quest The History of Spaceflight Magazine* 3 (Winter 1994) 5-12

May 23, 1955, the Ministry of Aviation Industry established OKB-256 at Podberiozye (later Dubna), with Tsybin as its Chief Designer, to design and develop a supersonic ramjet-powered strategic bomber named RS. By 1956, this ambitious undertaking had split into two variants: one an air-launched bomber, named 2RS, and the other a reconnaissance variant, called 3RS. Construction and managerial delays eventually prompted Tsybin to focus exclusively on the supersonic reconnaissance aircraft, renamed RSR, which was comparable to the American SR-71A ("Blackbird"). The Soviet government formally approved the project on August 31, 1956. Within three years, test pilots were flying experimental models of the RSR.⁴⁵

OKB-1 Chief Designer Korolev, still close to Tsybin, was aware of the latter's work and was particularly interested in the dynamics of the catapulted seat for the pilot, which Tsybin used on one of his "flying laboratories," the LL-1. At one of their meetings in 1958, Korolev asked Tsybin if he would be interested in conducting research on a reusable spacecraft that would return to Earth from space using lifting surfaces—that is, a spaceplane. Korolev specifically wanted something that could fit under the R-7's payload shroud. Tsybin, aware of the Air Force's recommendations and personally interested in the idea, agreed and established a group in his design bureau to study the problem."

The predraft plan for this vehicle, the first true spaceplane in the Soviet space program, was signed by Tsybin on May 17, 1959, and resulted from at least a year's worth of research. The three-and-a-half-ton (at launch) spacecraft, called the Gliding Space Apparatus (PKA) in official documentation, was nine meters long and equipped with two large wings, which could be folded upwards during certain portions of the mission. The fuselage itself was three meters wide and protected by a shield composed of two layers of thermal insulation, one with an organic silicon compound and the second with ultra-fine fiber. The portions of the vehicle that were expected to be exposed to the greatest thermal stress—the forward portion of the shield and the leading edges of the horizontal control surfaces and rudders—were cooled by liquid lithium. Temperatures at these points were expected to reach as high as 1,200 degrees Centigrade, while other parts of the vehicle would be exposed to only 400 degrees. The two large wings were protected from heat stress by folding upward, thus entering a "shadow" region.

The main fuselage consisted of two pressurized compartments—a cabin for the single pilot and a compartment for instrumentation—both of which had additional thermal protection. The pilot's cabin had an ejection seat much like the LL-1 and Korolev's Object K spacecraft, a control panel, and additional support systems. The ejection seat had three different positions, depending on the phase of the mission: one for launch, one for work, and one for rest. The pilot would have viewing access to the exterior through two side-mounted large windows and a smaller one for astro-navigation purposes. As in the Object K spacecraft, in case of a launch failure at altitudes below 10 kilometers, the pilot could abandon the vehicle with the ejection seat. If a failure came later in the launch trajectory, the PKA would separate from the 8K72 booster, unfold its wings, and land. The instrument compartment contained the equipment and systems required for orbital flight and reentry.

45 Piotr Butowski 'Steps Towards Blackjack: Soviet supersonic intercontinental bombers before the Tu 160' *Air Enthusiast* 73 (January-February 1998) 36-49 Bill Gunston 'The Osprey Encyclopedia of Russian Aircraft 1875-1995' (London Osprey Aerospace 1996) pp 376-78 G Amiryants 'Ivinsen's Chayka' (English title) *Aviatsiya i kosmonautika* no 4 (April 1990) 36-38 The RSR was eventually known as the R 020

46 Mikhail Rebrov 'Recounted for the First Time: PKA or Simply Lapotok' (English title) *Krasnaya zvezda* June 17 1995 p 4 Colovanov 'Korolev' p 765 On May 18 1959 Korolev sent a letter to the State Committee for Defense Technology in which he formally proposed inviting OKB 256 to develop a "gliding apparatus." This letter has been reproduced as S. P. Korolev 'On Gliding Return from Orbit' (English title) in Raushenbakh ed. 5 P. Korolev *ego delo* pp 271-72

Propulsion was provided through a bi-level system. A suspended propulsion system in the fairing and adjacent to the main fuselage shielding used two primary engines, with a thrust of 2.35 tons each, working on nitric acid and kerosene. One of these was the retrorocket, while the other was the "vernier," presumably for orbital corrections. The entire main propulsion system with a mass of about 780 kilograms would be discarded once retrofire had occurred at an altitude of ninety kilometers. A second system of propulsion was a set of three-kilogram thrust engines working on hydrogen peroxide for attitude control in orbit and for the descent.

The nominal mission length for the PKA was only twenty-four to twenty-seven hours, after which the spacecraft would de-orbit. Following reentry, it would use its uniquely shaped fuselage to provide lift. At an altitude of twenty kilometers and a velocity of 500 to 600 meters per second, the two wings would unfurl to their full span of seven and a half meters; control would be provided by the hydrogen peroxide thrusters throughout this phase. After a one-and-a-half-hour-long reentry, the 2.6-ton spacecraft would disembark on a runway at 180 to 200 kilometers per hour using bicycle-type ski landing gear, with the rear skis landing first.⁴⁷

Tsybin's engineers built models of the spacecraft, which Korolev nicknamed *Lapotok* (a sandal made of bark) because it resembled the shape of a sandal, and subjected them to wind tunnel tests at the Central Aerohydrodynamics Institute (TsAGI) at Zhukovskiy, the premier Soviet aeronautics research institution. The development of special materials for the PKA was undertaken at the Moscow-based All-Union Institute of Aviation Materials. Tsybin was also able to enlist several key Soviet aeronautical engineers into contributing to the program, including aerodynamicist Sergey A. Khrisianovich, thermodynamicist Vladimir A. Kirillin, and mechanics specialist Vladimir V. Struminskiy, all famous academicians in the country." Despite the large amount of work, the program apparently never received the official sanction of the Soviet Party or government, and it may have been an effort pushed by the Air Force, then in search of a solution to difficult times. The Air Force never did see the PKA fly. By late 1959, Tsybin's engineers realized that the thermal protection problem was far more complex than had been anticipated. Tests in wind tunnels showed that the material of the special thermal shielding would have to be changed if the spacecraft was to endure thermal stress during reentry. Furthermore, the hinged sections of the wings were prone to retain heat within a "dead zone." These and other problems prompted the effort's termination.⁴⁸

There may have been institutional problems, too. The downturn in the aviation industry led industrial leaders of the sector to close down a number of design bureaus; one of those was Tsybin's OKB-256. It is quite likely that poor research results in 1959 also prompted the chairman of the State Committee for Aviation Technology, Petr V. Dementyev, to suspend work on the RSR (later renamed the R-020) high-altitude reconnaissance plane, as military strategy was

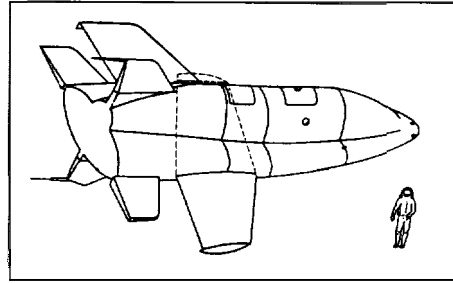

Pavel Tsybin's Gliding Space Apparatus (PKA) was the Soviet Union's first effort at designing a spaceplane; its hinged wings were capable of attaining different angles for different phases of reentry. (copyright Igor Afanasyev)

47 Valentin Bobkov "Space Sandal" (English title), *Krylya rodny* no 11 (November 1991) 25 | B Afanasyev "Unknown Spacecraft (From the History of the Soviet Space Program)" (English title) *Novoye v zhizni Nauke tekhnike Seriya kosmonautika astronomiya* no 12 (December 1991) 1-64 Rebrov "Recounted for the First Time "

48 Colovanov Korolev p 765 Khrisianovich was the director of the Institute of Theoretical and Applied Mechanics of the Academy of Sciences while Struminskiy was affiliated with TsAGI

49 Afanasyev "Unknown Spacecraft "

evolving more toward space-based reconnaissance. Thus the OKB-256's primary reason for existence also disappeared. On October 1, 1959, the enterprise was subordinated to another much more famous aviation design bureau, OKB-23 headed by Vladimir M. Myasishchev. By agreement with Korolev, the complete database on the PKA was handed over to a third firm, Artem I. Mikoyan's OKB-155, the builder of the famous MiG jet fighters. Tsybin himself was caught in the center of this maze of changes. He eventually found a place in 1961 at Korolev's design bureau as a deputy chief designer overseeing piloted space programs."

The specialty of Myasishchev's OKB-23 was long-range bombers, but like other aviation design bureaus, it had begun to make overtures to the missile and space industry. One of its first forays into the long-range missile business was as part of the stiff competition with Semyon A. Lavochkin's OKB-301 to develop the first Soviet intercontinental cruise missile as an alternative to Korolev's R-7 ICBM. The two cruise missile projects, having officially begun in 1954, had progressed at different paces, with the Lavochkin model, known as the La-350 Burya, taking an early lead. By 1955, OKB-301 had built and tested an operational model of the AN-2Sh astro-navigation system for the missile aboard a Tu-16 bomber. Signals from the stellar sensors were transmitted to the plane's autopilot for more than four hours, enabling the aircraft to automatically correct deviations in its flight path to less than four kilometers accuracy. The following year, Lavochkin's engineers had finished construction of the first flight models of the two-stage cruise missile (at Plant No. 18 at Kuybyshev)."

Launch attempts of the Burya commenced on August 1, 1957, from the Air Force's test range at Vladimirovka in the Volga delta near Kapustin Yar, at exactly the same time when Korolev was testing his R-7 from Tyura-Tam. The initial series consisted of launches of only a live first stage and a ballast second cruise stage. The first three tests were complete failures; the missile was, in fact, completely destroyed on the second attempt on September 1. During a second phase of eight launch attempts beginning in March 1958, engineers studied the parameters of the boost stage *prior* to the separation of the dummy second stage. Only one flight was successful. A subsequent phase of four launch attempts proved to be much more encouraging. On one of these launches, on April 19, 1959, the Burya performed without problems on a thirty-three-minute jaunt into the skies over a distance of nearly 1,800 kilometers."

Despite the relatively encouraging results, the La-350 Burya was a victim of its times. With the advent of the ICBM, this cruise missile was an anachronism. Because of its low flight altitude, eighteen to twenty-three kilometers, it was extremely vulnerable to defensive measures. It also took far too long, more than two hours, to reach its target. By comparison, ICBMs could do the same job in minutes. The Soviet government was also concerned that work on the Burya would divert resources from OKB-301's primary project, the long-range Dal anti-aircraft missile

50. The actual Plant No. 256, the location of one of the main design departments of OKB-256, was subordinated to the OKB-2-155 headed by Chief Designer A. Ya Bereznyak, an organization with no connection to the ballistic missile or space industry. See Butowski, "Steps Towards 'Blackjack'": Bobkov. "Space 'Sandal'". Afanasyev. "Unknown Spacecraft": *Amiryants*. "Ivensen's 'Chayka'". Jacques Villain, ed.. *Baikonour: la porte des étoiles* (Paris Armand Colin, 1994), p. 236; Rebrov. "Recounted for the First Time " As part of the research on the R-020, Tsybin had developed the NM-1 high-speed vehicle, which was flown thirty-two times starting in April 1959, albeit with poor results.

51 Boris V Rauschenbach. "The 'Burya' Intercontinental Cruise Missile," presented at the 43rd Congress of the International Astronautical Federation. IAA-92-0187, Washington, DC. August 28-September 5, 1992: 1. Afanasyev, "Without the Secret Stamp. Halt the Work. Destroy the Materials" (English title). *Aviatsiya i kosmonavtika* no. 6 (June 1993): 42-44.

52 V Aslanov. "Soviet Shuttle' of the 50s" (English title). *Apogee* 5 (June 1993). 1; Christian Lardier. "70 Years of Soviet Ramjets." presented at the 48th Congress of the International Astronautical Federation. IAA-97-IAA.2 3 03. Turin, Italy. October 6-10. 1997. Rauschenbach. "The 'Burya' Intercontinental Cruise Missile."

system for the city of Leningrad. On February 5, 1960, the Council of Ministers and the Central Committee issued a decree (no. 138-48) formally terminating all work on the Burya missile. By this time, nineteen examples of the missile had been manufactured, five of which remained unflown. The fate of OKB-301 took a further dive on July 9, 1960, when its patriarch, General Designer Lavochkin, died unexpectedly of a heart attack during missile testing of the Dal at Sary-Shagan. His successor, Mikhail M. Pashinin, retained the right to launch the remaining flightworthy models of the Burya. Three of the four launch attempts were spectacular. The last two in March and December 1960 were complete successes. Both missiles flew complete 6,500-kilometer flights to Kamchatka. All the remaining groundwork on the missile was, however, destroyed."

Myasishchev's competitive M-40 Buran fared even worse. Flight tests of the missile were slated to begin in August 1957, but there were innumerable delays in the project, most apparently because of Glushko's engines for the first stage. Two models of the Buran were apparently manufactured at the giant Plant No. 23 at Fili, but the spectacular success of R-7 ICBM sealed its fate. One month after the launch of the first Sputnik, the Soviet government canceled the Buran project without a single launch.⁵⁴ It seems that the cancellation of the Buran did not deter Myasishchev. Although he had a plethora of advanced bomber projects at his design bureau by the late 1950s, unlike many other aviation designers, he was keen to diversify into the space and missile programs." Myasishchev and Korolev had known each other for decades and had in fact worked together in the very same incarceration facility as prisoners during the early part of World War II. Myasishchev had been arrested for belonging to an aviation delegation that had visited the United States in the late 1930s. The two cooperated on a number of warplanes at the time and remained on good terms during the next fifteen years.

When Korolev was carrying out serious studies of human spaceflight on ballistic trajectories in late 1957 after the launch of the first Sputnik, Myasishchev began looking at designing a vehicle that could use aerodynamic surfaces during reentry. As with all aviation designers, Myasishchev had difficulty shifting his priorities to space. During a visit by Khrushchev to OKB-23 in August 1958, Myasishchev personally appealed for support to develop "rocket-plane" systems. Khrushchev replied, "Vladimir Mikhaylovich [Myasishchev], you are engaged [in] large themes in the field of aviation. This is your field. But questions of rocket technology are for us to decide and to provide."⁵⁵ Despite the negative response, Myasishchev's perseverance eventually paid off, and thus emerged the second spaceplane program in the Soviet Union.

OKB-23's reusable spaceplane project, which began in late 1957, was coordinated to a great degree with engineers at Korolev's OKB-1. Specifications of the R-7 ICBM were given to

53 Aslanov. "Soviet Shuttle' of the 50s"; Lardier. "70 Years of Soviet Ramjets", Afanasyev. "Without the Secret Stamp". S. M. Gann and V. I. Ivanovskiy. "The Multi-channel 'Dal' Anti-Aircraft Missile System of Great Range" (English title). *Neuskiy bastion* no. 1 (1998) 7-15

54 V. Petrakov and M. Chernyshov. "Without the Stamp 'Secret': The Unknown Buran" (English title). *Sovetskaya Rossiya*. April 10, 1991, p. 4; L. L. Selyakov. *Maloizvestnyye stranitsy tuorcheskoy deyatel'nosti aviatsionnogo konstruktora Vladimira Mikhaylovicha Myasishcheva* (Moscow: AO ANTK im. Tupoleva, 1997). pp. 109-12. The actual termination decree was issued on November 28, 1957.

55 Much of the OKB-23's resources were focused on the design of supersonic bombers, such as the M-30, M-31, M-32, M-33, and M-34, none of which were ever built. His most famous creation of the period was the M-50, a technology demonstrator for the M-52 supersonic bomber, whose first prototype flew on October 27, 1959. Other projects included the M-53 and M-55 (both supersonic airliners), the M-56 and M-57 (supersonic strategic bombers), the M-60 (a nuclear-powered bomber), and the M-70 (a flying-boat strategic bomber). See Butowski. "Steps Towards 'Blackjack'."

56 Petrakov. "Two Projects of V. M. Myasishchev."

Myasishchev's engineers, who determined the mass of a spaceplane (four and a half tons) as well as the optimal orbit (400 kilometers). Like Tsybin's PKA, OKB-23 project was also supported by the Soviet Air Force as a counterpart to the American Dyna-Soar, and for a brief period, there were actually two spaceplane projects in the USSR. Unlike Tsybin's brief stab at developing a hypersonic lifting body, it seems that Myasishchev's project was far more serious. Designated the M-48, the project was approved by the Soviet government and Communist Party in the same December 1959 resolution, which was the first macro-level policy statement on the Soviet space program. It thus became only the second fully sanctioned human spaceflight project in the Soviet Union. As with other efforts of such a scale, OKB-23 cooperated to a great degree with both OKB-1 and other research institutions, such as Keldysh's NII-1, which had pioneered research on high-altitude and high-speed aeronautics during the 1940s and 1950s, beginning with work on a Soviet version of the Sanger-Bredt antipodal bomber. OKB-23 also used its own rich database from the experience in designing the M-40 intercontinental cruise missile, especially in the area of thermal shielding. In March 1960, a delegation from OKB-23 visited Korolev's facility in Kaliningrad to acquaint themselves with progress on the Object K program as well as to facilitate the transfer of important technological innovations."

A governmental commission attached to the State Committee for Aviation Technology, the "ministry" overseeing the aviation industry, held a formal review of the project on April 8, 1960. Present were many leading experts from various aeronautics disciplines, who presented recommendations on the design of the M-48 spacecraft. Among the competing proposals was the use of a helicopter-landing scheme for the vehicle with a rotor diameter of eight meters. Other more traditional ideas revolved around using retractable or fixed wings, the use of liquid metal cooling, and the possibility of ballistic reentry. There was apparently much dissension on the issue of selecting a singular variant for the spaceplane, given that different aerodynamicists and aeronautical engineers argued for the benefits of their respective schemes. In a move clearly emphasizing the program's political importance, Deputy Chairman of the State Committee Aleksandr A. Kobzarev underscored the necessity of quickly developing an effective counterpart to the Dyna-Soar.

In the ensuing months, engineers proposed at least two major innovations in the development of the M-48. The thermal protection chosen for the vehicle was made of ultra-lightweight (for the time) ceramic foam characterized by its great fragility. Because it was necessary to have rigid wing surfaces, OKB-23 engineers chose to use thermal shielding in the form of tiles placed in layers with special adhesives. To ensure the safety of the shielding, they designed the ends of the tiles as conics and filled the spaces between them with quartz wadding impregnated with silicon resin. Tests of this configuration proved the soundness of this unusual design. A second innovation was the use of "electrodynamic analogs" to simulate behavior of the vehicle under different conditions. Thus the heat conductivity and thermal heat capacity of the construction was replaced by resistors, capacitors, and other electrical components. Resistances and potential differences at various points in the circuit simulated flight conditions, providing key information without resorting to actual flight testing. Engineers expended the most effort on the heat shielding, and they received several patents for the unique materials for different portions of the vehicle and the leading edge of the wings. At least 40 percent of the spacecraft was covered in special thermal protection.

Between March and September 1960, Myasishchev's engineers carried out intensive research on the final configuration of the M-48, leading to two final variants—one with a single fin at the rear (mass of 3.5 to 4.1 tons) and one with two fins at the tips of the wings (mass

of 3.6 to 4.5 tons). Although both spacecraft had similar performance characteristics, the former spacecraft was slightly longer (9.4 meters) than the latter (9.0 meters). Effective wingspan for both was seven and a half meters. The two-fin design, the smaller of the two variants, had a smooth outer contour resembling the Dyna-Soar, while the single-fin variant harked back to the paneled exterior of early proposals from Myasishchev in 1957-58. Unlike Tsybin's PKA design, neither of Myasishchev's spaceplane variants used hinged wings that could change their dihedral angles. Both spacecraft carried a cramped crew capsule for a single spacesuited pilot and an ejection seat. The mass of the seat and the pilot was limited to only 250 to 260 kilograms. The overall mass of the instrumentation amounted to 600 kilograms and included systems for navigation control, communications, life support, electrical power, and telemetry. Some parts of the apparatus for the M-48 were directly taken from Object K; these included the Chayka orientation system developed by NII-1 and the Zarya communications system developed by NII-695.

A nominal flight of the M-48 was to start on top of an 8K72 booster. In case of a booster malfunction, the pilot could eject from the stack at altitudes of up to eleven kilometers. After a daylong mission, the spacecraft would deorbit using a retrorocket engine with a thrust of 1.6 tons. At an altitude of forty kilometers, the pilot would begin controlled descent with a possible cross-range capability of 100 to 200 kilometers. The pilot would switch on a special turbojet engine at that point to provide final guidance. At an altitude of between five and eight kilometers, the pilot would eject from the vehicle in the ejection seat and land separately by parachute. The M-48 would then land independently at an airfield on skids. These skids were fairly small, with a length of 1.2 meters and a width of 0.25 meter."

The M-48 spaceplane was not the only visible manifestation of Myasishchev's intentions of making a name for himself in the new space program. There were other major space-related efforts at OKB-23, including the development of a conical descent capsule with a diameter of two and a half meters that had a truncated asymmetrical shape and steering jets for reentry. Tested successfully in wind tunnels, this was apparently meant for a future crewed space project.

There was also a project to design a new powerful three-stage space launch booster designated the M-1. The first stage of the rocket would be a cluster of four parallel boosters, each with seven thirty-five-ton-thrust engines. The second stage would comprise four similar blocks and the third stage one block. Overall length was thirty-six meters. The 700-ton mass launcher would be capable of orbiting a twenty-ton payload into low-Earth orbit, about four times as much as Korolev's modest 8K72 launcher." Unfortunately for Myasishchev, his bid for moving

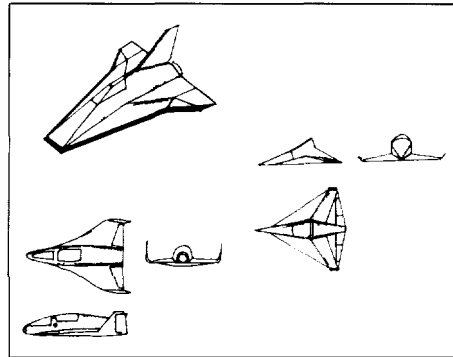

Three different conceptions of Vladimir Myasishchev's M-48 spaceplane project. At top is the single fin variant from 1958 to 1960 with a detachable ablative leading front edge. At lower left (in three views) is an "elongated flying wing" dating from 1960 which was considered one of the most promising designs. At right (in three views) is one of the earliest conceptions of the M-48 from 1957 to 1958, which was later abandoned. (copyright Asif Siddiqi)

58. *Ibid.*, Petrakov and Chernyshov, "Without the Stamp 'Secret': Mikhail Rebrov. "Work on the Theme No. 40, or Myasishchev's Spaceplane" (English title), *Krasnaya zvezda*, February 27, 1993, p. 6. Mikhail Rebrov, "Dark Journal, or the Sharp Twist of Fate" (English title), *Krasnaya zvezda*, December 9, 1995, p. 5.

59. Petrakov, "Two Projects of V. M. Myasishchev"; V. M. Petrakov, "From the History of the Development of Carrier-Rockets in the USSR" (English title), in *Trudy XXup chteniy, posvyashchennykh razrabotke nauchnogo nasladieniya i razvitiyu rdey K. E. Tsiolkovskogo* (Moscow: RAN, 1994), pp. 166-81.

from bombers to spacecraft ran headlong into the face of certainly one of the most dominant figures in the early Soviet space program, Vladimir Nikolayevich Chelomey.

Enter Chelomey

Chelomey, like Myasishchev and Tsybin, was from the aviation industry. In his early career as a chief designer, his primary focus was air-launched anti-ship cruise missiles, a thematic direction he started by creating the first Soviet pulse-jet engine during World War II. By 1953, his design bureau, OKB-51, had produced a number of modifications of the German Fi-103 "flying bomb." These missiles, such as the 10X, the 10XN, the 14X, and the 16X, were tested with varying degrees of success at Kapustin Yar during the same years that Korolev was proving out his early rockets. Despite a modicum of success with the experimental research, none of them were ever accepted for operational use by the Soviet Air Force, not only because of technical limitations but also due to internal organizational conflicts within the military." Chelomey's run with the cruise missiles came to an abrupt end on February 19, 1953, just two weeks before Stalin's death, when the Soviet leader signed a decree (no. 533-271) disbanding Chelomey's design bureau. The reason was political intrigue. One of Chelomey's primary competitors was Artem I. Mikoyan's MiG design bureau, OKB-155, which was competing with Chelomey to build coastal defense missiles. Mikoyan had a powerful ally in Sergey L. Beriya, the son of the dreaded Lavrentiy P. Beriya, who was the chief engineer at the Moscow-based KB-1, which produced the guidance systems for Mikoyan's KS-1 Kometa missile. Mikoyan and Beriya were able to push through a decision terminating work on all their competitors, including Chelomey." Mikoyan not only inherited Chelomey's plant, but a number of his designers and his database of research.

Chelomey found a research position at NII-642 in Moscow, but he was clearly restless for better things. Undeterred by the major setback, he found enough support within the Ministry of Aviation Industry to regroup twenty of his former engineers on June 9, 1954, into a Special Design Group (SKG) based at the Plant No. 500 in Tushino. The team quietly resumed work on the ground-launched 10XN, one of his most promising cruise missiles." Being an extremely ambitious man by nature, he was clearly not comfortable working on small projects. Unlike other designers of the era, he also considered himself more of a scientist than an engineer and was one of the few designers in the field who had the equivalent of a Ph.D. He had authored

60 For an exhaustive account of Chelomey's work during 1944-53, see Rostrslav Angelskiy, "Like the German 'V' There Was the Russian 'Tenth X'" (English title), *Aviatsiya-kosmonavtika* 19(8) (August 1996): 27-40. See also Valeriy Rodikov, "The 'X's' of Vladimir Chelomey" (English title), *Krylra rodiny* (August 1989): 6-7; G. Yefremov, N. Bogolyubov, and P. Kotov, "From War to Space Notes on General Designer V. Chelomey" (English title), *Krasnaya zvezda*, September 7, 1991, p. 5

61. Angelskiy, "Like the German 'V'"; Khrushchev, *Nikita Khrushchev*, pp. 368-70; Valeriy Rodikov, "Im vremya dest tainstvennyuyu znatnost . ." in V. Shcherbakov, ed., *Zagadkr zvezdnykh ostrovov kniga pyataya* (Moscow: Molodaya gvardiya, 1989), pp. 13-14; Mikhail Rebrov, "'Akula' and Others: From the History of Winged Missiles" (English title), *Krasnaya zvezda*, February 5, 1994, p. 5; Yevgeniy Yerokhin, "When the 'Storm' Ended as the 'Still'" (English title), *Krylra rodiny* no. 10 (October 1995). The same order also terminated work on the R-1 Storm missile (at OKB-293 headed by M. R. Bisnovat) and the RAMT-1400 Shchuka missile (at GSNII-642 headed by M. V. Orlov).

62 Aleksandr Shirokorad, "Rakety nad morem" (English title), *Tekhnika i vooruzheniye* no. 11-12 (November-December 1997): 1-80; Gerbert Aleksandrovich Yefremov, "NPO Mashinostroyeniya Is Moving Into the High-Technology Market" (English title), *Vooruzheniye politika, konversiya* 3 (1995): 31-37; M. Tarasenko, "35 Years for the OKB 'Vypel'" (English title), *Novosti kosmonavtiki* 8 (1998): 43-44. The Ministry of Aviation Industry signed an order dated May 19, 1954, ordering the Plant No. 475 to resume the manufacture of 100 10XN missiles. This number was later reduced to fifty. See Angelskiy, "Like the German 'V'."

dozens of papers and a number of textbooks on such topics as aerodynamics, the theory of pulse-jet engines, and the phenomenon of vibration. Within the scientific community, he was highly respected: as a designer at Kapustin Yar, he was just as prone to be engaged in solving complex mathematical arcana as directing a launch. In this respect, he was exactly the opposite of Korolev, who had always been a "hands-on" technical person with a talent for managing. Chelomey, on the other hand, was a scientific prodigy of sorts, albeit with sometimes unrealistic but ambitious goals and less managerial skill than Korolev. Chelomey's gall and ambition continually surprised his closest colleagues, and the number of setbacks he would receive in his checkered career never once seemed to stunt his reach for resources and access to the top.

Clearly at the nadir of his career in 1954, Chelomey drew up a proposal for a new naval cruise missile. He approached a top admiral in the Navy, Pavel G. Kotov, and convinced him in a few hours that the Navy could not do without such a new and original weapon. By a stroke of fortune, the Ministry of Aviation Industry had also decided to establish a number of new design bureaus to focus on naval projects. A panel of famous scientists from the Academy of Sciences, including Keldysh, reviewed the naval cruise missile proposal and recommended it as a prospective direction of research. Chelomey also had a more powerful backer. Khrushchev recalled in his memoirs:

One day [Chelomey] asked me for an appointment to show me a model of a new missile he'd developed. He explained that it was a tactical missile like the German V-1 flying bomb, but it had special features: the wings could be folded up, and it could fit into a long barrel. When it was fired, the wings spread so that it looked like an airplane. I thought that the comrade had come up with an original and useful idea. . . .⁶³

There were some in the Ministry of Defense who opposed allowing Chelomey resources, but Khrushchev had the last word. In August 1955, Keldysh telephoned Chelomey and informed him that he had been assigned an empty tract of land with a tiny factory, the Reutov Mechanical Plant, located in the outskirts of Moscow. Here he would work on his pet design.⁶⁴ On Chelomey's personal request, much of his old database was returned to him from Mikoyan's design bureau. The group that Chelomey established there, by an official order on August 8, 1955, would eventually become one of the largest defense enterprises in the Soviet Union, the Experimental Design Bureau No. 52 (OKB-52).⁶⁵

Between 1955 and 1958, Chelomey focused all his energies on his new missile, designated the P-5, which was tested in the North Sea from Soviet Navy submarines. He made an unprecedented and rapid rise from obscurity and by 1958 was vying for parity with the leading chief designers in the Soviet defense industry. His small design bureau had also expanded: a team of skilled engineers under Aleksandr D. Nadiradze was attached to OKB-52 in December 1957 to focus on solid-propellant missile research. The same Nadiradze would

63 Nikita S. Khrushchev, *Khrushchev Remembers: The Last Testament* (Boston: Little & Brown, 1974), p. 44.

64 Rodikov, 'The Xs of Vladimir Chelomey', p. 14; Khrushchev, *Nikita Khrushchev*, pp. 371-72; Nina Chugunova, 'V. N. Chelomey: Highlights of His Biography' (English title), *Ogonek* 4-5 (January 16-30, 1993), 24-29; Rebrov, 'Akula and Others'; The review panel for Chelomey's missile included M. V. Keldysh, A. A. Dorodnitsyn, and A. Yu. Ishlinskiy. For a short history of the Chelomey organization, see *Raketno-kosmicheskaya otasl' Rossi* (Moscow: Assotsiatsiya sodeystviya kosmicheskoy nauke i tekhnike, 1996), p. b. 134.

65 Not all of the Special Design Group relocated to the Reutov Mechanical Plant in August 1955. It was only after minor plant renovation in 1956 that all of Chelomey's team moved to Reutov from Tushino. See Yefremov, 'NPO Mashinostroyeniya is Moving.'

decades later design one of the most potent missiles in the Soviet arsenal, the so-called SS-20.⁶⁶ The P-5 missile itself had a mixed future. It was meant to be the first nuclear-armed Soviet naval missile, a counterpart to the U.S. Navy's *Regulus*. Chelomey's rocket, however, was cumbersome to prepare for launch and had poor accuracy." Despite these weaknesses, the P-5 was declared operational on June 19, 1959, and Chelomey and a large number of his staff received important state awards, including the prestigious Hero of Socialist Labor for Chelomey himself. Later on July 3, 1959, he was named the general designer of his organization, a title that was more prestigious than the more common *chief* designer, but one that only existed in the aviation industry.

Apart from pure ambition and technical expertise, by this time Chelomey had a much more powerful ally. In March 1958, Khrushchev's son, Sergey Nikitich, joined the OKB-52 as a deputy chief of the department dedicated to guidance systems. By the younger Khrushchev's account, it had been his own decision to join Chelomey's design bureau, but it was obvious that Chelomey capitalized on the unexpected course of events. As one scientist in the space program later observed:

... Chelomey was an absolute master at using their personal triangle for the advancement of his ambitions. It is not that Chelomey got hints or requests from Nikita Khrushchev to promote his son. The stories I heard gave the completely opposite scenario. It was Chelomey who had taken the initiative."

Chelomey never hesitated to shower the Soviet leader with stories of his son's great technical expertise. The motives of both the older Khrushchev and Chelomey continue to remain obfuscated amid plaintive accusations of nepotism and outright jealousy in the eyes of other designers, but one fact is clear: the Soviet leader displayed a marked favoritism toward Chelomey by the late 1950s. Whether this was because of his son's unique position or merely whimsical is probably something that will never be known. The older Khrushchev did not hide his support of Chelomey. At a major display of military weaponry held at Kapustin Yar as part

66 Nadiradze's team had come from GSNII-642. This institute traced its lineage back to KB-2, which was established on May 13, 1946, to work on the German Hs-293A missile and later the RAMT-1400 Shchuka air-launched cruise missile. On December 15, 1951, KB-2 was combined with Plant No. 67 and renamed the State Union Scientific-Research Institute No. 642 (GSNII-642). Although its work on the Shchuka was discontinued in 1953, GSNII-642 continued work on other missile programs derived from the Shchuka. Chelomey's new OKB-52 was made a branch of GSNII-642 on November 6, 1957. Their positions evidently reversed on March 8, 1958. A subdivision from GSNII-642, SKB-2, was headed by Nadiradze. See Dmitry Khrapovitskiy, ed., *Generalnyi Konstruktor Akademik V. N. Chelomey* (Moscow: Vozdushnyi transport, 1990), p. 67. The solid-propellant theme was not pursued for very long at OKB-52 because Chelomey was apparently not interested in it. In 1958, Nadiradze's SKB-2 separated from Chelomey and was transferred to NII-1 within another ministry, the State Committee for Defense Technology, where it pursued the development of solid-propellant ballistic missiles. Nadiradze became the director of NII-1 in 1961 and went on eventually to develop a series of solid-propellant ICBMs for the Strategic Missile Forces. See Mikhail Rebrov, "When the Topol Bloomed . . . The Most Secret of the Designers" (English title), *Krasnaya zvezda*, February 25, 1995, p. 5; G. A. Yefremov, "Anniversary V. N. Chelomey—80 Years" (English title), *Noustr kosmonavtiki*, 12–13 (June 4–July 1, 1994), 68–70; Lardier, "70 Years of Soviet Ramjets", *Christian Lardier, "Solid Propellant Rockets in the Soviet Union."* presented at the 49th International Astronautical Federation, IAA-98-IAA-2.3.09, Melbourne, Australia, September 28–October 2, 1998; R. Angelskiy "Flying Shchuka" (English title), *Tekhnika i oruzhiye* no. 2 (1997), 9–16.

67. Steven J. Zaloga, *Target America: The Soviet Union and the Strategic Arms Race, 1945–1964* (Novato, CA: Presidio, 1993), p. 185; Shirokorad, "Rakety nad morem."

68. Roald Z. Sagdeev, *The Making of a Soviet Scientist: My Adventures in Nuclear Fusion and Space from Stalin to Star Wars* (New York: John Wiley & Sons, 1993), p. 202.

of the Operation *Bereza* in September 1958, Khrushchev made overt gestures in favor of Chelomey. As a participant recalled: "I noticed that when Khrushchev visited our static display, he spent a large portion of his time—50 minutes—studying Chelomey's stands, whereas he only devoted 10 minutes to the missiles designed by Korolev, Yangel, and others."⁶⁹ This was only six months after his son had joined OKB-52.

Chelomey's ascendance into the upper echelon would not be of any significance for Korolev or Yangel were it not for Chelomey's one crucial decision in 1958–59 to expand his horizons. Having spent the previous four years engaged in designing short-range tactical missiles for the Soviet Navy, Chelomey was well aware that the real prestige lay elsewhere—that is, in designing ICBMs and spacecraft. One of his early stabs at these themes was an ambitious idea to extend the capabilities of his naval cruise missiles by combining the benefits of winged and ballistic rockets. The Central Committee and the Council of Ministers issued a formal decree on July 2, 1958, permitting initial work on the development of winged-ballistic missiles at OKB-52.⁷⁰ After launch on a ballistic trajectory, the payload would reenter Earth's atmosphere in a capsule and release the winged missile, which, using its own wings and a jet engine, would guide its self-homing warhead, either conventional or nuclear, to its destination. The primary targets of these so-called "Aircraft Warheads" were evidently foreign battleships around the world. The slated range of the winged-ballistic missile was about 8,000 to 10,000 kilometers. It was during the research on this concept that Chelomey first expanded his reach from missiles into the space arena—specifically, the development of launch vehicles and spacecraft. As early as July 1959, he presented some initial space-related concepts to the powerful Defense Council of the Presidium of the Central Committee.

Based on the experience of developing cruise missiles and his exploratory composite winged-ballistic research, Chelomey's engineers began to study a wide range of problems. Unlike Korolev's entry into the space program, Chelomey began thinking big from the start. As Khrushchev's son later recalled:

[He] started with the most exotic: flight to the other planets. Chelomey fell for plasma engines. . . a spaceship untwisting itself in a spiral around the Earth until it would tear itself away from it . . . [and then] lay on a trajectory to Mars or Venus. Another idea resembled a ship: a winged rocket in a container would be carried above the atmosphere, do an intricate pirouette: diving into the stratosphere on wings and changing the trajectory, it would use supplementary engines to direct itself back into orbit. It would be able to fulfill missions of reconnaissance, photography, or carry out space-targeted bombings. But most of all Chelomey wanted to build a winged piloted ship. That would be highly maneuverable. He did not abandon the idea to the very last days of his life."

OKB-52's overall entry into the Soviet space program began under two broad themes called Kosmoplan ("Space Glider") and Raketoplan ("Rocket Glider"). Research on both tracks began in 1959. Admittedly, engineers used these names somewhat generically in the same way that Korolev's engineers named their first creations "space ships." In fact, Chelomey used the Kosmoplan and Raketoplan names precisely because they were different from Korolev's "space ships," to distinguish his own efforts from what he considered the pedestrian ways of Korolev's engineers.

69 Lt Gen Aleksey Kalashnikov "Archives of Russian Armaments Operation Bereza This Was the First View of Our Missile Shield" (English title) *Krasnaya zvezda* December 17, 1994 p 6 Mozhzhorin *et al* eds *Dorogi v kosmos II* p 27

70 E mail correspondence, Igor Afanasyev to the author November 23, 1997

71 Khrushchev Nikita Khrushchev pp 480–81

In its initial conception, the Kosmoplan was an automated winged space vehicle designed to accomplish missions in deep space." The spacecraft would perform its mission in three distinct phases:

- The Kosmoplan would be launched into a low-Earth orbit by existing or future launch vehicles.
- The Kosmoplan would slowly accelerate into a spiral trajectory around Earth using its own engines, and then accumulate sufficient speed to "shoot off" into a trajectory to the Moon, Mars, or Venus.
- After completing its mission, the Kosmoplan would return to Earth."

It seems that Mars was a primary goal for the Kosmoplan. At the Red Planet, the spacecraft would use special cameras and probing sensors to study the planetary phenomena. Chelomey's engineers conceptualized a very unique reentry profile for the spaceplane. Just before reaching Earth's atmosphere, a conical apparatus, shaped somewhat like a folded umbrella, would extend out from the vehicle. Once the Kosmoplan entered the upper atmosphere at a slight angle to the horizontal, this unfurled "umbrella" would shield the spacecraft proper from thermal stresses. After atmospheric reentry, at a velocity of Mach 2, the Kosmoplan would jettison the "umbrella." and the plane would swerve appropriately and finally land at an airport landing strip.⁷⁴

From a general perspective, the Kosmoplan theme encompassed only lunar and interplanetary flight, but confusingly, OKB-52 engineers also foresaw using the Kosmoplan in near-Earth space—that is, specifically, for missions in Earth orbit at altitudes of eighty-five to 105 kilometers for military reconnaissance missions. Thus, ultimately, Chelomey proposed two subclasses of the Kosmoplan, one for deep space missions and one for near-Earth orbital flight. Missions would originally begin with automated flights and then lead to piloted missions, especially in the near-Earth orbit variant. Ultimately, however, Chelomey's goal was a piloted expedition to Mars with a subsequent return and landing back on Earth.

Functionally, the Kosmoplan was divided into two major sections: a compartment for engine units and a return compartment. Taking into consideration the requirement for acceleration out of Earth orbit as well as the needs for aerodynamic braking near the atmosphere from low-Earth orbit, the engineers examined several different possible engine units for both subclasses of Kosmoplans. These included chemical liquid-propellant rocket engines, nuclear rocket engines, and electric rocket engines. After intensive analysis, Chelomey's engineers concluded that electric rocket engines with a nuclear power source would be optimal for achieving all of the possible goals of the Kosmoplan. The electric rocket engine would consist of mechanisms to convert a nuclear reactor's heat into electrical power, a plasma engine, and radiators to dissipate heat. The return compartment itself comprised a "braking container"—that is, a narrow cylinder that unfurled into the umbrella-shaped thermal shield for controlled aerodynamic reentry into Earth's atmosphere. Once the umbrella was discarded, the container would open up to reveal the spaceplane proper, an aircraft with folded delta wings, short in length but sharply swept back. The spaceplane would have its own turbojet engine for disembarking on conventional runways.

According to engineering analyses, the Kosmoplan design offered some significant advantages over standard ballistic spacecraft using chemical liquid-propellant rocket engines, such as

72 Interview. Cerbert Aleksandrovich Yefremov by the author, March 3, 1997.

73. E-mail correspondence. Igor Afanasyev to the author. November 28, 1997.

74 Igor Afanasyev, "Kosmoplan: Chelomey's Project" (English title), *Krasnaya zvezda*. August 26, 1995, p. 6

those designed at the Korolev design bureau. For example, Chelomey believed that the useful payload of the Kosmoplan for a mission to Mars would be as high as 15 percent of the initial spacecraft mass at low-Earth orbit. There was, of course, also the benefit of reusability by returning the most valuable portion of the entire system back to Earth."

The Raketoplan was slightly less ambitious than the Kosmoplan, but it was still a far leap from Korolev's modest Object K effort. The primary goal of the Raketoplan project was to transport payloads and people over intercontinental distances by reusable space vehicles—that is, it was meant exclusively for use in near-Earth space. Unlike the Kosmoplan, however, Chelomey believed that the Raketoplan could serve as some kind of futuristic space weapons bomber, something much akin to the Sanger-Bredt concept of years before. The Raketoplans would be launched vertically on conventional rockets and then perform suborbital ballistic flights with aerodynamic braking, maneuvering, and then landing at airports with a set of turbojet engines and landing gear. In their initial studies, OKB-52 engineers studied two-stage Raketoplan systems with both tandem and parallel staging. The second stage, the actual spaceplane, would fly the assigned mission, reaching velocities as high as eight kilometers per second.

OKB-52 studied two basic types of Raketoplans in 1959 and 1961, one for a range of 8,000 kilometers and one for a range of 40,000 kilometers. The modest version would be launched from pads located at latitudes close to Moscow and then, by flying over the North Pole, would be able to land at airfields at latitudes close to Washington, D.C. If the spacecraft was launched from even higher latitudes, then points as south as Cape Canaveral would come into its range of landing. The longer range model would be able to launch off any point in the Soviet Union and fly over the South Pole and up to any point in the United States, evading the radar systems of the North American Air Defense Command (NORAD). After its mission, the Raketoplan would land anywhere in the Soviet Union.

The two-stage design of the Raketoplan consisted of a winged first stage, which would return to a landing strip after it imparted sufficient velocity to the second stage. In one scenario, the single pilot in the first stage would use turbojet or ramjet engines fixed to the ends of the two wings to return to an airfield near the launch complex. The carrier aircraft had a range of 600 kilometers. In a second conception, the first stage would simply be a heavy glider. After launching the spaceplane into the upper atmosphere, this glider would land at an airfield about 600 to 800 kilometers from the launch pad. A special suspended jet engine installation would allow the first stage to return back to the launch area at subsonic speeds. The landing would be performed on wheels.

The spaceplane, or second stage, of the Raketoplan represented a hybrid of a rocket and a supersonic jet plane. The vehicle included propellant tanks for the fuel and oxidizer, intertank compartments with systems for tank pressurization, and a tail compartment with a liquid-propellant rocket engine. There was a pressurized sealed cockpit for the pilot at the forward end of the ship. The sweptback wings were attached to the middle part of the main fuselage. The aft part of the spaceplane included a cruciform tail assembly and a turbojet engine next to the main liquid-propellant rocket engine. Overall, given its primary mission of bombing enemy targets, OKB-52 engineers believed that it had one major advantage over intermediate-range ballistic missiles, such as Yangel's R-12 and R-14: the Raketoplan could maneuver in the atmosphere unlike missiles, which were preprogrammed with a trajectory prior to launch. No doubt, the fact that the Raketoplan system was completely reusable added to its attractiveness as a new weapon of the Soviet armed forces."

75 Correspondence, Igor Afanasyev to the author, November 28, 1997

76. *Ibid*

These grand proposals from Chelomey would probably have sunk into obscurity, by 1959, had it not been for Chelomey's support system within the Communist Party, the government, and the military. First and foremost, he had access to Khrushchev personally on a regular basis, on a par with Korolev's own influence with the Soviet leader. In the Party, he could count on Ivan D. Serbin, the chief of the Defense Industries Department in the Central Committee, who served as somewhat of a watchdog within the defense sector, making sure that the Party's official policy was being carried out in "proper" ways. Serbin remains one of the least talked about individuals in the history of the Soviet space program, a situation that is completely disproportionate to the remarkable power he wielded over almost a quarter of a century. He was apparently a terrifying figure to many, thus inheriting the nickname "Ivan the Terrible" during his tenure as Party apparatchik for the defense sector. Very little is known about his background; his biographies merely state that he began working in the innards of the Party in 1942, rising to his current position in February 1958. He was forty-eight years old at the time.⁷⁷



Ivan Serbin was the chief of the Central Committee's Defense Industries Department from 1958 to 1981. More commonly known as "Ivan the Terrible."

he was the doctrinal watchdog for the Soviet missile and space programs, wielding considerable influence over not only personnel changes, but also policy (files of Peter Gorin)

Within the government, Chelomey also had the strong unequivocal support of Petr V. Dementyev and Aleksandr A. Kobzarev, the chairman and deputy chairman, respectively, of the State Committee for Aviation Technology. Dementyev had been one of those who had decided in 1945 to relinquish missiles to the armaments industry, but with Chelomey's strong reach for missiles and space, he no doubt saw Chelomey as a way out from the near-catastrophe that was facing the aviation sector. Chelomey also had very powerful enemies, primarily in the person of Dmitriy F. Ustinov, the chairman of the Military-Industrial Commission. Ustinov's initial dislike of Chelomey was understandable: Chelomey was coming from the aviation industry into the missile business, which had been dominated by people such as Korolev and Yangel who had been nurtured under Ustinov within the armaments industry. For Ustinov, this was an unacceptable intrusion into his affairs. During Khrushchev's reign in power, there was, however, little Ustinov could do. Although he was the chairman of the Military-Industrial Commission — certainly one of the most powerful jobs in the Soviet defense industry — Ustinov had to answer to Serbin and ultimately to Khrushchev. It was a no-win situation. Chelomey, very much aware of the "Ustinov problem," completely bypassed normal institutional means and usually took his proposals straight to Khrushchev, thus ensuring that they would be given a fair look without an outright rejection from Ustinov.⁷⁸

77. Edward L. Crowley, Andrew L. Lebed, and Dr Heinrich E. Schulz, eds. *Prominent Personalities in the USSR* (Metuchen, NJ: The Scarecrow Press, 1968), p. 547

78. Telephone interview, Sergey Nikitich Khrushchev by the author, October 10, 1996

Korolev himself was predictably protective of his domain. As Chelomey began to make inroads into the arena of space. Korolev was dismissive of his plans, calling them "a circus" of ideas.' Sometime in 1959, soon after Korolev's successful lunar mission to the far side of the Moon. Chelomey sent two of his leading deputies, Cerbert A. Yefremov and Valeriy Ye. Samoylov, to meet with Korolev to discuss his future plans. When the two explained that Chelomey was interested in multiple-use spacecraft as part of a complex system of orbital operations, Korolev was aghast. According to Yefremov. Korolev replied at one point: "Why do we need such a system at the present time? Right now all this is fantastic. In space right now it's necessary to solve [more specific] goals, for example like . . . photographing the far-side of the Moon."'' By Yefremov's account, it was apparently at that point that the discourse between the two designers started to degenerate into competition instead of cooperation.

Chelomey, undeterred by Korolev's criticisms, took his complex plan for space exploration straight to the top at a meeting in early April 1960. The general designer had been eager to meet with Khrushchev to discuss his plans for some time. During a short vacation in Crimea, Khrushchev took the opportunity to invite not only Chelomey, but also several important players involved in the development of Soviet naval missiles." There were three main problems on the agenda: the next generation of naval cruise missiles, problems with gyroscopes in naval missiles, and the question of future anti-satellite systems.

After discussions on naval missiles, Khrushchev allowed Chelomey to present his plans for space. Chelomey came prepared with a plethora of charts and diagrams and began expounding on a plan for a large-scale Earth-orbital complex made of space stations, winged reusable transport ships, communications satellites, cargo spacecraft, and huge orbital space factories. The Raketoplan-Kosmoplan idea was at the crux of much of his presentation, and Chelomey expounded clearly that one of the major problems of developing such systems would be adequate thermal protection, which would take years to perfect. This first segment was followed by his offering for a military space complex at the core of which was a battle station equipped with nuclear projectiles in revolving turrets. Khrushchev was apparently getting bored at this point by this overtly ambitious plan. and Chelomey quickly changed the subject to more modest plans—in particular, a system for recovering hostile satellites from orbit for inspection. Once again, one of the central tenets of his plans was a winged vehicle with a large payload bay for stowing captured satellites. Moving on, he described another space-based system for intercepting incoming ICBMs. probably the first-ever discussion at a high level in the Soviet Union on a strategic defense program paralleling the American "Star Wars" program of the 1980s. Chelomey also presented conceptions of new automated space-based anti-satellite and ocean reconnaissance systems, the kind that would allow operational capability by 1962–63.⁸⁷

Chelomey finished his prepared speech and then asked Khrushchev for authority to develop his own space launch vehicle. Khrushchev's interest perked up when Chelomey explained that his space launcher would be designed in such a way that it could also be used as a new efficient ICBM. Since about 1958, the general designer had explored several conceptions of launch vehicles (such as the A-300) and ICBMs (such as the A-200) in preparation for this

79 Khrushchev *Nikita Khrushchev* p 480

80 G A Yefremov "Where *Salyut* Started (English translation) in Khrapovitskiy ed *Generalnyy Konstruktor Akademik V N Chelomey* p 8

81 Those present included B Ye Butoma (Chairman of the State Committee for Ship Building) V N Chelomey (General Designer of OKB 52) P V Demytyev (Chairman of the State Committee for Aviation Technology) Admiral S G Gorshkov (Commander in Chief of the Military Naval Fleet) N S Khrushchev (First Secretary of the Central Committee) S N Khrushchev (Deputy Chief of an OKB 52 Department) and V I Kuznetsov (Chief Designer of NII 944) See Khrushchev *Nikita Khrushchev* pp 484–85

82 *Ibid* pp 485–89

moment. The A-200 ICBM, later renamed the UR-200, was the center of Chelomey's proposals. The rocket, in its space launch version, would have a payload capability of three to four tons to low-Earth orbit, putting it in a lighter class than concurrent Soviet launch vehicles such as Korolev's 8K72 and 8K72K boosters for the Object K program." In typical fashion, Chelomey elected not to use the traditional "R" index normally reserved for all previous Soviet long-range missiles, but introduced the "UR" index, standing for "universal missile" in Russian. This was a direct reference to his idea that such missiles would have dual use as space launch vehicles and ICBMs. The "200" was a rough estimate of the total launch mass of the new rocket.

Chelomey wanted approval for the Raketoplan, the Kosmoplan, the UR-200, as well as two automated military systems, an anti-satellite system named "IS" ("Satellite Destroyer") and a radar ocean reconnaissance satellite system named "US" ("Guided Satellite"). There was also the question of the huge battle stations in orbit, but all of this no doubt overwhelmed Khrushchev. His son recalls that after hearing Chelomey's prognosis about war in space, all the attendees sat there "looking depressed [and] made no comment." While Khrushchev declined to approve the more ambitious and outlandish plans, the Soviet leader did see a point in forging ahead with work on the UR-200 ICBM as a competitor to new missiles from the Korolev and Yangel design bureaus. He also evidently found the IS anti-satellite proposal worthy of further consideration. His son later wrote that at the end of the meeting, "Father began talking about how important the proposed program seemed to him. If war reached into space—he thought Chelomey's arguments were very convincing—then we must not allow ourselves to be caught unprepared." Chelomey's boss, Chairman Dementyev, also piped in, cautiously supporting Chelomey's grand plans.

All Chelomey needed were the resources to carry out his program. In an incredibly shrewd move, he took advantage of Khrushchev's favorable impressions and explained that to carry out such large-scale work, he would need some additional help, maybe another design bureau or a production plant. Playing on Khrushchev's anathema toward strategic aviation, this ploy worked. Dementyev suggested that there was Myasishchev's excellent design bureau in Fili with its adjacent production factory, Plant No. 23, which could be very useful for Chelomey. It was well known that Khrushchev had been unhappy for a while with the performance of Myasishchev's bombers. After a cursory discussion on the poor results of some of Myasishchev's products, Khrushchev told Dementyev to draw up the appropriate governmental decree to transfer Myasishchev's design bureau and his plant, wholesale, to Chelomey. Thus, the April 1960 meeting was the effective death knell not only for Myasishchev's bombers, but also his radical spaceplane design, the M-48.

In a strange irony, Myasishchev had been involved in a project to design a new ICBM with Chelomey. In 1958 and 1959, during the latter's initial exploratory studies for a new generation of missiles, Chelomey had signed a preliminary agreement with Myasishchev and another aviation designer, Pavel O. Sukhoy of OKB-51, to develop a new two-stage ICBM for the Strategic Missile Forces. Myasishchev would build the first stage, while Sukhoy would be responsible for the second stage. Chelomey would build the warhead container. At some point in the autumn of 1960, ballistics reviews by Myasishchev's designers proved that there were fundamental flaws in the design submitted by Chelomey. At a meeting to discuss the issue, Myasishchev's deputies were critical of the proposal as a whole, which no doubt angered the proud Chelomey. As one of Myasishchev's engineers recalled: "After that meeting the fate of OKB-23, and

83 Dmitriy Khrapovitskiy "Absolutely Unclassified: The Ground Waves of Space Politics" (English title) *Soyuz* 15 (April 1990) 15

84 Khrushchev *Nikita Khrushchev* p. 490

85 *Ibid.* p. 492

personally of V. M. Myasishchev was determined. Moreover, it was stated that Myasishchev was a jet expert but now, of necessity. [suddenly] a rocket expert."⁸⁶

In Chelomey's view, Myasishchev had stepped over the line. It was, however, too late for him. On October 3, 1960, by Central Committee and Council of Ministers decree no. 1057-434, Myasishchev's design bureau was formally renamed OKB-52 Branch No. 1; all his bomber projects were terminated. His space projects, such as the M-48 spaceplane, the crew return capsule, and the M-1 launch vehicle, fared no better. Myasishchev was forced to stand by and witness as his entire database of research, accumulated over almost a decade, was handed out part and parcel to two other design organizations. Sukhoy's OKB-51 and Tupolev's OKB-156. His personnel remained behind at the old design bureau haunts to wait for new orders from Chelomey." Myasishchev was apparently offered the luckless job of working under Chelomey as head of Branch No. 1, but he refused and instead moved out of the whole design business into pure science research as the new director of TsAGI, the most important aeronautics research institution in the Soviet Union." Chelomey meanwhile inherited a completely new organization, its excellent engineering staff, as well as one of the largest production facilities in the USSR, Myasishchev's Fili plant. While yet to make a concrete stab at the piloted space program, Chelomey had left no doubt about the breadth of his ambitions.

The Big Space Plan

Chelomey was not the only one thinking big at the time. All of the several long-range plans that Korolev had submitted to the government through 1959 required the development of huge and powerful launch vehicles to support large-scale space operations. Preliminary studies on heavy-lift launch vehicles began in the Soviet Union in 1956. In August of that year, Glushko had circulated a proposal to all the other major chief designers and to then-Minister of Defense Industries Ustinov about a new booster based on the R-7 design, but with each block having two 100-ton-thrust engines, thus having a total thrust of 1,000 tons. He had expected a preliminary paper project on the issue to have been completed by November of the following year, but work on the R-7 ICBM had precluded serious inquiry." Korolev had also inaugurated such studies at his own design bureau. The first mention of such a vehicle in OKB-1 archives is dated September 14, 1956, and describes a vehicle with a launch mass of 1,000 tons. The question was once again discussed at a meeting of the Military-Industrial Commission on July 15, 1957, with the unanimous recommendation that future heavy-lift boosters not use the cluster configuration used on the R-7. The designers agreed that LOX should be used as oxidizer because it provided higher specific impulse than storable propellants.⁹⁰ The issue was considered premature at the time, but the commission approved further preliminary research on the topic. OKB-1 plans for 1959-60 also mentioned a similar project, and in December 1959, the gov-

86 Petrakov 'Two Projects of V. M. Myasishchev' Petrakov 'From the History of the Development of Carrier Rockets'

87 S. A. Zhiltsov ed. *Gosudarstvennyy kosmicheskiy nauchno-proizvodstvennyy tsentr imeni M. V. Khruncheva 80 let* (Moscow: GKNPTs Khrunichev, 1997) p. 52. Petrakov and Chernyshov 'Without the Stamp Secret' Selyakov *Maloizvestnyye stranitsy tvorchestvo* pp. 114-15.

88 V. A. Fedotov 'The Scientific Research Activities of V. M. Myasishchev' (English title) *Iz istorii aviatsii i kosmonavтики* 50 (1984) 3-13. Christian Lardier *L'Astronautique Soviétique* (Paris: Armand Colin, 1992) p. 152.

89 Vetrov 'Development of Heavy Launch Vehicles'

90 *Ibid.* Vetrov 'The Difficult Fate of the N1 Rocket' There was also a meeting of the Council of Chief Designers on the same day addressing similar topics. One source states that the specifications for the new booster were a launch mass of 1,000 to 2,000 tons and payload values of forty to ninety tons. See R. Dolgopyatov, B. Dorofeyev, and S. Kryukov 'At the Readers Request: The N1 Project' (English title) *Aviatsiya i kosmonavtika* no. 9 (September 1992) 34-37.

ernmental decree on the space program included a clause authorizing exploratory studies at OKB-1 on the topic of heavy-lift boosters.

The effort to determine the specifications for the next generation of Soviet launch vehicles was, in more than one way, intrinsically connected with the qualitative nature of the future of the Soviet space program. The December 1959 decree on space had hesitantly approved a number of projects, but far less than what Korolev had been lobbying for. But between December 1959 and mid-1960, there was a remarkable turnaround in the manner in which the Soviet leadership viewed their space program. Soviet space historians themselves have been unable to clearly explain the abrupt shift. One respected Russian space historian, Georgiy S. Vetrov, has suggested that the about-turn was prompted primarily by actions not in the USSR, but by one individual in the United States. Democratic Senate Majority Leader Lyndon B. Johnson of Texas. Johnson had played a major role in the formation of NASA, and he continued to criticize the seemingly ineffectual actions of the Eisenhower administration through the years after Sputnik. As chairman of the Senate Aeronautical and Space Sciences Committee, he had authored a memorandum on the use of the arena of space in the interest of national defense, which had alarmed the Soviets. In a statement typical of the period, Johnson told the Democratic Caucus in 1958 that:

Control of space means control of the world. . . . There is something more important than the ultimate weapon. That is the ultimate position—the position of total control over Earth that lies in outer space . . . and if there is an ultimate position, then our national goal and the goal of all free men must be to win and hold that position."

Later, in February 1960, Johnson had been primarily responsible for increasing the NASA budget request for the 1961 fiscal year by a figure of \$168 million. Statements by Herbert F. York, the Director of Defense Research and Engineering at the Department of Defense, advocating a strong military component to the U.S. space program, were also evidently viewed with much alarm by the Soviets.⁹¹

Prompted by NASA's long-range plans for space exploration, Khrushchev found a sudden interest in the Soviet space program. On January 2, 1960, he summoned the primary motivators of the space program—Korolev, Glushko, Keldysh, and Pilyugin—and unexpectedly asserted that Soviet successes in space were no less important than military rockets. Korolev quoted Khrushchev's exact words the next day when he met with Keldysh, other chief designers, and all his principal deputies: "Your affairs are not well. You should quickly aim for space. There's broad and all-out levels of work in the U.S.A. [in this field] and they'll be able to outstrip us."⁹²

During the following month, it was clear that the basic thematic direction of the Soviet space program was going to be military. Believing that pronouncements of Johnson and York were symptomatic of the military nature of the U.S. space program, the Soviet leadership wanted to compensate for the overtly "civilian" nature of the December 1959 space plan. Thus, proposals were floated in early 1960 for a plethora of different military projects. As with the U.S. space program, most of the proposals were centered around the development of a heavy-lift launch vehicle. In a rush to receive approval in this window of opportunity, both Korolev and

⁹¹ Lyndon Johnson *& The American Dream* (New York: Harper & Row, 1976), p. 145, referenced in Harford Korolev, p. 252.

⁹² David Baker, *The History of Manned Spaceflight* (New York: Crown Publishers, 1985), pp. 50–51; Vetrov, 'The Difficult Fate of the N1 Rocket', interview Georgiy Stepanovich Vetrov by the author, January 9, 1997. In July 1960, York had threatened the Saturn program with cancellation because he believed that the project had no military utility.

⁹³ Chertok, *Rakety i lyudi: Fiti Podlipki Tyuratam*, p. 318.

Clushko offered up wildly differing proposals for heavy boosters. Unlike Korolev, who favored a qualitative leap in design, Clushko, in 1959 and 1960, had explored the possibility of using the R-9 ICBM as the basis for a heavy-lift launch vehicle. His conservative approach was to cluster together seven R-9s as the first stage and four as the second stage. The launch mass of the booster would be 1,500 tons. A subsequent version would replace the R-9's standard RD-111 engines with more powerful ones and have a launch mass of 2,000 tons.⁹⁴ In an April 1960 letter to Korolev on the proposal, Clushko ended on a dramatic note: ". . . any other decision [other than proceeding with the R-9-based launcher] will strike a blow to the priority and prestige of Soviet attempts to conquer space. . . ."⁹⁵ Korolev was not impressed, and he sent back an official letter the following month evidently rejecting Glushko's proposal.

For almost two months beginning early February 1960, Korolev ensconced himself with his leading deputy chief designers—Vasily P. Mishin, Sergey S. Kryukov, and Boris Ye. Chertok—to hammer out the details of a new "big space plan." Initially, the four explored a 1,600-ton booster with a nuclear engine as the second stage. This idea, although tempting, was tempered by the uncertainty about nuclear propulsion technology at the time.⁹⁶ As a result of these studies, the men enumerated three preliminary operational goals for the new launch vehicle

- * Defense-related projects in low-Earth orbit
- The creation of a global system of space-based communications and weather-forecasting satellites
- The exploration of the Moon and the inner planets"

Although all the studies were carried out internally at OKB-1, the final recommendations of the group were apparently circulated to all the principal chief designers in March stating that OKB-1 had finalized all the primary requirements and operational characteristics and missions of the new booster. This initial proposal recommended using LOX propellants for all stages of the launch vehicle as well as nuclear, electric, and liquid hydrogen engines for the upper stages. Kryukov, responsible for assessing different configurations of a new launch vehicle, explored more conventional ideas of both longitudinal and transverse staging. The designers finally decided to dispense with the old cluster scheme as in the R-7 ICBM and proposed a tandem three-stage design. Initially, they agreed on a very broad range of specifications: launch mass of 1,000 to 2,000 tons and payload capability to low-Earth orbit of forty to eighty tons. Under pressure from Mishin, and with objections from Kryukov, Korolev agreed to invite other engine designers to participate in developing the booster—in particular, Chief Designer Kuznetsov of OKB-276, who had made a failed bid to develop engines for Korolev's R-9 ICBM. Apart from boosters, the designers produced an extensive list of plans for the piloted space program, such as developing ships with electric engines and systems for orbital assembly.

94. Vetrov. "Development of Heavy Launch Vehicles"; M. Rudenko. "The Moon Slips Away: Chronicles of an Unknown Race" (English title), *Ekonomika i zhizn* 45 (November 1991): 19. The latter source has a slightly different description of Glushko's new booster. According to one of Glushko's deputies, M. I. Osokin, Glushko proposed that "the first stage . . . would comprise of [sic] six blocks of the same diameter arranged in a circle, of the R-7 or the R-9, but augmented in length and having the RD-111 engine from the R-9 installed in each block. The central block, also augmented, would have one RD-111 engine installed, but for high altitude use and high altitude firing. . . ." The two Glushko proposals were known as the R-10 and the R-20, respectively, and both used the LOX-unsymmetrical dimethyl hydrazine propellant combination.

95. Rudenko. "The Moon Slips Away."

96. Chertok. *Rakety i lyudi. Filii Podlipki Tyuratam*, pp. 344-45.

97. Dolgopyatov, Dorofeyev, and Kryukov. "At the Readers' Request: The NI Project."

When Clushko first saw the plan, he immediately rejected Kuznetsov's participation in developing the booster and evidently made an aborted attempt at getting Yangel to offer a competitive proposal. Eventually, he changed his mind and sided with the remaining council members.⁹⁸ By early April, Korolev prepared a draft of his proposal in the form of an official Central Committee and Council of Ministers decree, which he sent to the Military-Industrial Commission with the agreement of eight chief designers. Within days, he decided to completely revise his conceptions when he realized that his future in space would depend heavily on Chelomey's rising ambitions.⁹⁹ Perhaps with knowledge of Chelomey's recent meeting with Khrushchev in Crirnea. Korolev ceded some of his monopoly over the new Soviet space program. In a revamped version of his draft decree, dated May 30, 1960, Korolev grudgingly included Chelomey's design bureau as a leading player in the piloted space effort. OKB-I retained its grip on the development of a super heavy-lift launch vehicle. Korolev met with Khrushchev in early June 1960 to explain the booster proposal. He emphasized both its military utility as well as more grandiose plans for the exploration of the Moon, Mars, and Venus. The payload capability would be ten times more than any existing booster, and Korolev promised that the booster would be ready by 1963, if given the necessary resources. In a departure from common practices, Korolev named his new projected series of boosters, "N." denoting *nositel*, the Russian word for "carrier."

The Central Committee and the USSR Council of Ministers signed the "big space plan" into law on June 23, 1960, as decree number 715-296. Titled "On the Creation of Powerful Carrier-Rockets, Satellites, Space Ships and the Mastery of Cosmic Space in 1960-67," it was the blueprint for the Soviet space program in the 1960s.¹⁰⁰ Although the actual decree remains classified, Korolev's original draft for the "big space plan" has been published; it seems that many, if not all, of the original points from Korolev's plan were enthusiastically approved by the Soviet Communist Party and government following Khrushchev's sudden about-turn on the space program. The draft itself remains a remarkable record of the stunning ambition of the early Soviet space program. The eleven-point decree had four major sections:

- Enumeration of the major thematic directions of work
- Enumeration of timeframes for future activities
- Robotic exploration
- Earth satellites¹⁰¹

The core of the plan was the OKB-I proposal to develop a series of heavy boosters to support various military and civilian programs. Tailored to fit a variety of missions, a general upper payload limit of seventy to 100 tons to a 300-kilometer orbit was specified in the decree. Launch mass would vary between 1,000 to 2,000 tons, depending on the variant. Engineers would carry out initial planning and design work for the boosters during 1960-62, concurrent with research

98 Chertok, *Rakety i lyudi. Filii Podlipki Tyuratam*, p. 345.

99 The text of the first version of the plan, dated April 12, 1960, has been reproduced in full as "Planning Decree of TsK KPSS and the Council of Ministers for the Future Mastery of Cosmic Space" (English title), in Raushenbakh, ed., 5 P Korolev i ego delo, pp. 289-93. Korolev's attached cover letter, dated April 7, 1960, is also reproduced in the same source on pp. 287-89. The eight chief designers were V. P. Barmin, A. F. Bogomolov, V. P. Clushko, N. D. Kuznetsov, V. I. Kuznetsov, A. M. Lyulka, N. A. Pilyugin, and M. S. Ryazanskiy.

100 Vetrov, "The Difficult Fate of the N1 Rocket": N. P. Kamanin, *Skrytiy kosmos kniga pervaya 1960-1963gg* (Moscow: Infotekst IF, 1995), p. 19.

101 The Korolev proposal for the decree, dated May 30, 1960, has been published as "Planning Decree for TsK KPSS and Council of Ministers" (English title), in Raushenbakh, ed., 5 P Korolev i ego delo, pp. 295-301. Korolev's cover letter with the decree, published as "Letter to S. I. Vetoshkin and K. N. Rudnev" (English title), is in the same source on pp. 294-95.

on a new generation of chemical, nuclear, liquid hydrogen, and low-thrust electric rocket engines. In addition, the decree called for the development of new control, guidance, and communications systems, new launch complexes, ground command and control systems, anti-satellite battle systems, long-duration piloted spacecraft, and "systems for solving defense-related goals" by using navigation, geophysical communications, and weather satellite systems. A large portion of the decree was clearly dedicated to military goals, reflecting the Soviet government's newfound interest in militarizing this new frontier. The decree called for the creation of a "military space station" not only for space-based reconnaissance but also full-fledged battles in space. Smaller "military satellite-ships" would conduct radar reconnaissance and have the capability to inflict damage to both earthly and space-based targets. Korolev added a paragraph proposing that these new rocket boosters could also be used to "significantly promote the development of peaceful science and culture," including the creation of radio and television broadcasting, weather, navigation, astronomy, and geophysical satellite systems.

The second portion of the document addressed specific projects. OKB-1 listed specifications for its new generation of heavy-lift boosters. There would be two launch vehicles:

Booster	Timeframe	Payload to Low-Earth Orbit	Payload to the Moon
N1 (or 11A51)	1960-62	40-50 tons	10-20 tons
N2 (or 11A52)	1963-67	60-80 tons	20-40 tons

The N2 vehicle would use liquid hydrogen, ions, plasma, and nuclear engines in its upper stages. These rockets would allow three new piloted projects to be implemented, all also developed by OKB-1:

Project Designation and Description	Period	Goals (all would have crews of two to three cosmonauts)
Object KS (piloted heavy satellite ship)	1961-63	Reconnaissance and anti-satellite missions: would also have a "civilian" variant
Object KL (piloted lunar ship)	1961-64	Circumlunar and lunar orbital missions
Object KMV (piloted interplanetary ship)	1962-65	Circumplanetary missions to Mars and Venus

Among the projects addressed in the second portion of the decree were the development of robotic probes to the Moon, Mars, and Venus and new updated launch vehicles using the R-7 and R-9 ICBMs. Draft plans for both new launch vehicles would be ready by 1961, with flights initiated the following year. The third part called for the further development of the existing Object K spacecraft in four versions: for piloted missions in 1960 and 1961, for automated photo reconnaissance from 1961 to 1963, for scientific research in 1960 through 1962, and for rendezvous and docking in orbit in 1961 through 1963. All would be launched by R-7-based launch vehicles. Korolev also included a point on the development of a scientific satellite named Elektron to study Earth's radiation belts. Three subsections detailed new developments in small Earth-orbiting satellites for communications, meteorology, and scientific research given

to other organizations, such as Yangel's OKB-586.¹⁰² All this was to be accomplished from 1960 to 1967, with OKB-I as the primary contractor for most of the projects.

In retrospect, it is clear that the decree was hastily put together, wildly ambitious, and remarkably unrealistic. Attempting to take advantage of the favorable conditions that existed for a few months in 1960, the Council of Chief Designers proposed a macro-level plan that completely ignored the limitations of national economic resources as well as organizational barriers. The latter was of particular importance because few of the institutional changes recommended by Korolev and Keldysh, in their 1959 letter to the government, were addressed in the decree. The space program remained an arm of the defense industry, and its future course remained intertwined in the needs, policies, and actions of individuals whose first priority was much more earthly in nature. Thus, such grandiose goals as *piloted* flight to the Moon and planets, which had no obvious military utility, generated zero interest from the primary financiers of the space program, the Ministry of Defense.

Like Korolev, Chelomey had also proposed a mix of "civilian" and military space programs. Government officials had evidently worked on the details of Chelomey's specific programs after the important April 1960 meeting with Khrushchev in Crimea:

- An automated Kosmoplan (Object K) would be developed for flight to the Moon, Mars, and Venus, capable of returning to Earth on a conventional runway. The spacecraft would use high-energy liquid propellant, nuclear, plasma, and ion engines. Two variants were projected, one with a mass of ten to twelve tons and a more advanced twenty-five-ton model for flight in 1965 or 1966.
- A draft plan would be completed by 1962 for a new space launch vehicle with a mass of 600 tons for launching the Kosmoplan.
- A naval reconnaissance satellite (Object US) would be developed in 1962 through 1964 to aid in targeting Chelomey's P-6 anti-ship missile against U.S. naval assets.
- A Raketoplan (Object R) would be developed for Earth-orbital flights, capable of landing on any conventional airfield. The spacecraft would have a mass of ten to twelve tons and a flight range of 2,500 to 3,000 kilometers. The robotic variant would be ready by 1960 or 1961, the piloted variant between 1963 and 1965, and the military anti-satellite variant between 1962 and 1964.¹⁰³

These and other projects from Chelomey were the subject of a second decree (no. 715-295) issued on the very same day as Korolev's "big space plan." In Chelomey's case, the actual decree approved the creation of the piloted spaceplane, the Raketoplan, whose primary mission

¹⁰² 'Planning Decree for TsK KPSS and Council of Ministers' *op cit* Boris Arkadyevich Dorofeyev "History of the Development of the NI L3 Moon Program" presented at the 10th International Symposium on the History of Astronautics and Aeronautics, Moscow State University, Moscow, Russia, June 20-27, 1995. M. Chernyshov, "Why Were Soviet Cosmonauts Not on the Moon?" (English title) *Leninskoye znamya*, August 1, 1990, p. 3. There is one source that purports to contain descriptions from the actual decree. See Golovanov, *Korolev*, pp. 710-11. According to this source, the details of the decree were slightly more ambitious, including the development of an Earth-orbital spaceship for crews of two to three people, automatic lunar satellites, and automatic lunar landers that would return to Earth. Also listed were research on carrying out piloted expeditions to the Moon to investigate its terrain, the selection of sites for establishing lunar settlements, and, after construction of such a base, the creation of a transport system for the Earth-Moon-Earth route. At the same time, a spaceship would be developed for crews of two to three people to carry out orbital missions to Mars and Venus, which, among other things, would select locations for future research bases on the surface. After these bases were established, regular interplanetary flight of crews would begin. A separate paragraph was allegedly also dedicated to launching automatic spaceships to the outer planets—in particular, Jupiter.

¹⁰³ Planning Decree for TsK KPSS and Council of Ministers, *op cit*.

was to conduct anti-satellite missions in Earth orbit.'" Additional decrees in October 1960 and March 1961 dramatically bolstered Chelomey's presence in the Soviet space program by formally initiating his works on the "IS" robotic anti-satellite spacecraft system, the "US" naval reconnaissance system, and the UR-200 ICBM/space launch vehicle.¹⁰⁵

Chelomey's overt pandering to military interests clearly played in his favor. Within a span of less than a year, Chelomey had entered as a serious competitor to Korolev in almost every area of the space and missile programs—from ICBMs to piloted spacecraft, from interplanetary probes to military space systems. Chelomey's new empire was not limited to future creations but also to more earthly assets, such as the absorption of the Myasishchev design bureau, OKB-23, and its associated Plant No. 23, in October 1960. At the same time, the June 1960 decree also allocated huge amounts of funds to begin large-scale construction at OKB-52's premises at Reutov.¹⁰⁶

The climate of the Soviet space program changed dramatically in the course of the three years after the launch of the first Sputnik. From a few isolated projects in 1957, by 1960 it was poised to expand into a large-scale undertaking far in excess of what was planned in the United States at the time. The internal nature of power and influence had also evolved. Where Korolev once was the only player in the game, there was fragmentation and competition. In the Western sense of the word, competition had the connotation of a proactive plurality of opinions, which fostered creativity and efficiency. In the centralized and socialist Soviet system, with resources restricted by the needs of the defense sector, it gave rise to chaos.

In 1957, Korolev had a singular vision of a Soviet space program moving across the great expanse. By 1960, Chelomey had made his entry with a plethora of competitive proposals, which in some cases were diametrically opposed to those of Korolev. Korolev's favored engine designer, Glushko, had arrived as a powerful force of his own, but estranged from his former friend. Finally, Yangel had taken Korolev's place as the favorite missile designer, thus shifting allegiances in the military, the primary financiers of the space program. All this, of course, happened behind a wall of secrecy. Only the best and the brightest were shown to the public. In that respect, the crowning achievement of the public Soviet space program was still to come.

104. Ibid

105. There is evidence to suggest that the Soviet government may have approved preliminary research on the IS, US, and UR-200 systems in the same June 1960 decree. See Sergey Khrushchev, *Nikita Khrushchev, krizisy i rakety vzglyad iznutri* tom 2 (Moscow: Novosti, 1994), p. 50. Note that the author states that the decree in support of these programs was in July 1960, not June 1960. This seems to be a typographical error. The robotic "IS" satellite program was officially initiated by a Communist Party and government decree on October 3, 1960. See Raushenbakh, ed., *S. P. Korolev i ego delo*, p. 680. N. S. Simonov, *Voyenno-promyshlennyy kompleks SSSR v 1920–1950-ye gody. tempy ekonomicheskogo rosta, struktura, organizatsiya proizvodstva i upravleniye* (Moscow: ROSSPEN, 1996), p. 301. The "US" program was approved by two decrees, on March 16, 1961 (no. 420-174), and on June 3, 1962. See Mikhail Rudenko, "Designer Chelomey's Raketoplans" (English title), *Vozdushniy transport* 48–49 (1995), 8–9. The development of the UR-200 ICBM/launch vehicle was officially approved by decrees on March 16, 1961, and August 1, 1961. See I. Afanasyev, "35 Years for the 'Proton' RN" (English title), *Novosti kosmonavтики* 1–2 (1998) 45–48.

106. Yefremov, "NPO Mashinostroyeniya is Moving "



CHAPTER SEVEN

GAGARIN

In the three years from 1958 to 1960, a continuous series of proposals and counterproposals set the stage for establishing policy directions for the new Soviet space program. If, at the time of the first Sputnik, the space program was a minor offshoot of the ballistic missile effort, then by 1960 it began to emerge as a separate field ready for exploitation and support. Because of its origins in the rocketry program, the military's involvement in the space effort continued to be pervasive. The piloted component of the Soviet space program had in fact risen hand-in-hand with the development of the first Soviet reconnaissance satellite. And when it came time to select volunteers for the first outbound voyages into space, it was once again the armed forces that served as a pool for qualified individuals.

The Cosmonauts

Discussions on the type of passengers to be used for the first orbital space missions began concurrently with the January 1959 decree calling for biomedical preparations for human spaceflight. Four months later, representatives from the military, the science sector, and the design bureaus met at the offices of the Academy of Sciences, under Vice-President Keldysh's supervision, to discuss means and standards for selecting volunteers for the space missions. The attendees considered individuals from a variety of professional backgrounds, such as aviation, the Soviet Navy, rocketry, and car racing. It was at the insistence of Air Force physicians that Keldysh approved a plan to narrow the pool to only qualified Air Force pilots. The doctors convincingly argued that Air Force training, which included exposure to hypoxia, high pressure, g-loads along various axes, and ejection seat experience, would all be relevant to training for space missions.¹ One other factor may have also affected the decision to choose pilots. In April 1959, NASA selected its first astronauts, all seven coming from aviation backgrounds in the American armed forces.

The Soviet Air Force issued a document at the time, titled "Directive of the General Staff of the [Air Force] for the Selection of Cosmonauts," which entrusted a Deputy Commander-in-Chief of the Air Force, Col. Gen. Filipp A. Agaltsov, with the administrative duties to carry out the task. Agaltsov's job was made easier by the fact that the space medicine group at the Air Force's Institute of Aviation Medicine had had a long history of involvement in the rocketry business. Led by the ubiquitous Lt. Col. Yazdovskiy, this team developed basic and initial requirements for the candidates in coordination with OKB-1 engineers. At an early meeting to

1. Yu. A. Mozzhorin *et al.*, eds., *Dorogi v kosmos II* (Moscow: MAI, 1992), p. 144

discuss these specifications. Chief Designer Korolev presented the specifications for the would-be "cosmonauts." The men, and only men were considered. were to be between twenty-five and thirty years of age. no taller than 1.70 to 1.75 meters, and with a weight no more than seventy to seventy-two kilograms—all requirements sufficient to allow for accommodation in the small 3KA capsule, the piloted variant of Object K. Korolev was candid about the skills of these would-be cosmonauts:

As has been repeatedly demonstrated in our automated flights and those with animals on board, our technology is such that we do not require, as the American Mercury project does, that our early cosmonauts be highly skilled engineers. The American astronauts must help control the rocket systems at every stage of the flight.'

While this was strictly not true, it was an indication of the depth to which automation was an intrinsic factor in the early Soviet piloted space program. During the entire selection phase. Korolev emphasized repeatedly that one of the primary criteria for the pilots would be the necessity to carry out precisely programmed functions—a requirement that in truth left the candidates with much less control than they would have had flying a simple aircraft. The final specifications for the future cosmonauts were frozen by June 1959 in a document approved by three Air Force institutions—the Institute of Aviation Medicine, the Central Scientific-Research Aviation Hospital, and the Central Commission for Aviation Medicine—as well as the USSR Academy of Sciences and the USSR Academy of Medical Sciences.¹

Yazdovskiy's team at the Institute of Aviation Medicine, being a large group of physicians with a variety of interests, had been organized into different departments for the selection process, with sections for general physiology, psychology, life support systems and hygiene, and the actual selection of candidates. Yazdovskiy appointed Nikolay N. Gurovskiy and Yevgeniy A. Karpov, two Air Force physicians, to oversee the candidate selection process." Groups of doctors in pairs were then sent to a number of major Air Force bases in the western Soviet Union. Doctors at the bases were also consulted on the issue, and by August, the selection process had commenced with inspections through the records of more than 3,000 pilots. Most were eliminated at an early stage because of height, weight, and medical history. Grounds for exclusion, based on the last criterion, included certain diseases such as chronic bronchitis, angina, predisposition to gastritis and colitis, renal and hepatic colic, and pathological shifts in cardiac activity. The remaining pilots were then interviewed beginning September 3 with questions on their health, goals, moods, work, and quality of life. Even at this point, none of the volunteers were aware of the nature of the mission, which was disguised under the euphemism of "special flights." Gurovskiy recalled later:

The conversation [with the pilots] had nothing whatsoever to do with space. Some officers had no idea what we were getting at and why we had come, while others on the contrary got the point immediately and asked permission to consult with their family.

2 Yevgeni Karpov "Beginnings" in Viktor Mitroshenkov ed. *Pioneers of Space* (Moscow: Progress Publishers, 1989) p. 18.

3 Mozhgorin *et al.* eds. *Dorogi v kosmos II* p. 147.

4 Each doctor at the institute was assigned a specialty in the field of space biomedicine in preparation for piloted missions. They were: V. I. Yazdovskiy (chief), O. G. Cazenko (physiology), A. M. Genin and A. D. Seryapin (hygiene and life support systems), F. D. Corbov (psychology), and N. N. Gurovskiy and Ye. A. Karpov (selection and preparation of cosmonauts, which was the Department 7 at the institute). Apart from the Air Forces Institute of Aviation Medicine, the Central Scientific-Research Aviation Hospital (TsNIAG) and the Central Commission for Aviation Medicine (TsVVK) were also involved in the preliminary stages of cosmonaut selection.

We had to absolutely forbid this: it was a new, top-secret project, and the prospectus had to make the decision himself, without outside assistance.'

Just over 200 individuals passed this early screening and were then sent in groups of twenty for further testing at the Central Scientific-Research Aviation Hospital in Moscow. Testing under the "Theme No. 6" program formally began on October 3. Scores of individuals dropped out of the race at this point as the resilience and will of the young Air Force pilots faltered in the face of the extremely demanding and rigorous tests. Apart from further interviews, there were a number of physical tests. One involved spinning the pilot in a stationary seat to test the vestibular apparatus. Another subjected the volunteers to low pressure in a barometric chamber. A third was a classical centrifuge to test high gravity loads. It seems that original plans called for a small group of seven or eight pilots, but Korolev insisted on tripling this number because he wanted a group much larger than the NASA astronaut team. At the end of 1959, a team of doctors approved twenty men to serve as candidates for the first team of cosmonauts.⁵ They were told to return to their units to await further orders.

On January 11, 1960, Soviet Air Force Commander-in-Chief Marshal Konstantin A. Vershinin formally signed plans to establish a center exclusively dedicated to the training of the cosmonauts for the upcoming piloted flights. The directive called for the use of an old two-story building situated on the premises of the M. V. Frunze Central Airfield on Leninskiy Prospekt in Moscow. Institutionally, the new center, officially called the Cosmonaut Training Center (TsPK), was subordinated to the Air Force's Institute of Aviation Medicine. The thirty-eight-year-old Karpov, who had been involved in cosmonaut selection, was appointed the first Director of TsPK by official order on February 24.⁶ The initial staff at the facility numbered about 250. Although the new center was nominally under the control of physicians, the Air Force General Staff ultimately exercised total supervision of all cosmonaut affairs via one high-ranking officer who would become one of the most prominent personalities in the history of the Soviet human space program, Nikolay Petrovich Kamanin.

A lieutenant general in the Soviet Air Force, Kamanin was well known to the Soviet populace even before the existence of the Soviet space program. As a twenty-five-year-old pilot in February 1934, he had led a daring rescue mission to the Arctic to save the crewmembers of the ship *Chelyushkin*, who had been stranded on floating ice.⁸ For this particular act, Kamanin had the distinction of being the very first Soviet citizen bestowed with the "Hero of the Soviet Union" title, an honor reserved for great acts of bravery. By the late 1950s, Kamanin was serving as the first deputy chairman of a voluntary youth organization dedicated to training boys and girls for future service in the armed forces. Clearly, his stature as a famous public aviator was crucial to his appointment because it seems that he had not been involved in any significant high-priority military projects in his entire career. He was relieved of his previous duties at

5 Col V Gorkov 'History of the Space Program Resident of Startown' (English title) *Aviatsiya i kosmonautika* no 1 (January 1990) 20-23

6 Mozhorin *et al* eds *Dorogi v kosmos II* pp 147-148 Christian Larder *L'Astronautique Soviétique* (Paris Armand Colin 1992) pp 125-26 The selection commission included V I Yazdovskiy N N Gurovskiy Ye A Karpov and F D Gorbov from the Institute of Aviation Medicine and K F Borodin I I Bryanov Ye A Fedorov and M D Vyadro from TsNIAG and TsVLK

7 Gorkov 'History of the Space Program' V Ponomarenko and I Alpatov 'Our Contemporaries The Source of Cosmonautics' (English title) *Aviatsiya i kosmonautika* no 12 (December 1990) 38-39 Karpov's deputies at TsPK were Air Force officers N F Nikersayov (political worker) Ye Ye Tselikin (director of flight training) V V Kovalev (head of the training section) and A I Susuyev (head of the logistics section) TsPK's 'real' designation was the military unit no 26266

8 Pavel Popovich and Alexander Nemov 'Galactic Secrets' in Mitroshenkov ed *Pioneers of Space* pp 200-01

the time and officially appointed the Deputy Chief of the Air Force's, General Staff for Combat Preparations. His duties included supervising the selection, training, and administration of the new cosmonauts and reporting directly to the high command of the Air Force, including Commander-in-Chief Marshal Vershinin.⁹ Although the junior Karpov officially headed the Cosmonaut Training Center, it was effectively the fifty-one-year-old Kamanin who controlled its most important activities. For the following ten years, no Soviet cosmonaut would get off the ground without his blessing.

On February 25, Kamanin formally approved the final short list of twenty candidate cosmonauts selected by the end of 1959. These young men, along with seven others across the world, represented the first group of people to prepare for voyages into outer space. The twenty were:

- Senior Lieutenant Ivan N. Anikeev (twenty-seven years old)
- Major Pavel I. Belyayev (thirty-four)
- Senior Lieutenant Valentin V. Bondarenko (twenty-three)
- Senior Lieutenant Valeriy F. Bykovskiy (twenty-five)
- Senior Lieutenant Valentin I. Filatev (thirty)
- Senior Lieutenant Yuriy A. Gagarin (twenty-five)
- Senior Lieutenant Viktor V. Gorbatko (twenty-five)
- Captain Anatoliy Y. Kartashov (twenty-seven)
- Senior Lieutenant Yevgeniy V. Khrunov (twenty-six)
- Captain Engineer Vladimir M. Komarov (thirty-two)
- Lieutenant Aleksey A. Leonov (twenty-five)
- Senior Lieutenant Grigoriy C. Nelyubov (twenty-five)
- Senior Lieutenant Andrian G. Nikolayev (thirty)
- Captain Pavel R. Popovich (twenty-nine)
- Senior Lieutenant Mars Z. Rafikov (twenty-six)
- Senior Lieutenant Georgiy S. Shonin (twenty-four)
- Senior Lieutenant German S. Titov (twenty-four)
- Senior Lieutenant Valentin S. Varlamov (twenty-five)
- Senior Lieutenant Boris V. Volynov (twenty-five)
- Senior Lieutenant Dmitriy A. Zaykin (twenty-seven)"

Of the group, five had not met the age criteria of being between 25 and 30, but this condition was waived because of their performances in the selection procedures. Two in particular, Belyayev and Komarov, were the most educated and experienced members of the team, having already graduated from Air Force academies. Because of the age restriction, none of the selected were test pilots, unlike some of their U.S. colleagues. Komarov had some experience as a test engineer flying new aircraft, but the most experienced pilot, Belyayev, had accrued only 900 hours of flying time. Others such as Gagarin had flown only 230 hours. Only one pilot, Popovich, had flown what was then considered a high-performance aircraft, the MiG-19.¹¹ To a large extent, this was a direct result of the high degree of automation in Soviet piloted

⁹ Kamanin nominally reported to four Air Force officers: his immediate superior Air Force General Staff Chief Col Gen P I Brayko; Air Force Deputy Commander-in-Chief Col Gen F A Agaltsov; Air Force First Deputy Commander-in-Chief Marshal S I Rudenko; and Vershinin.

¹⁰ "At the Request of the Readers: Detachment of Air Forces Cosmonauts" (English title) *Aviatsiya i kosmonavtika* no. 5 (May 1990): 46-47.

¹¹ Yaroslav Colovanov, *Korolev Fakty i mify* (Moscow: Nauka, 1994), p. 605. Rex Hall, "Soviet Air Force Cosmonauts," in Michael Cassutt, ed., *Whos Who in Space: The International Space Year Edition* (New York: Macmillan, 1993), p. 210.



The original 1960 group of cosmonauts is shown in a photo from May 1961 at the seaside port of Sochi. The names of many of these men were considered state secrets for more than twenty five years. Sitting in front from left to right Pavel Popovich, Viktor Gorbatko, Yeugeny Khrunov, Yuriy Gagarin, Chief Designer Sergey Korolev, his wife Nina Koroleva with Popouch's daughter Natasha, Cosmonaut Training Center Director Yeugeny Karpov, parachute trainer Nikolay Nikitin, and physician Yeugeny Fedorov. Standing the second row from left to right Aleksey Leonov, Andrian Nikolayev, Mars Rafikov, Dmitriy Zaykin, Boris Volynov, German Titov, Grigoriy Nelyubov, Valeriy Bykovskiy, and Georgiy Shonin. In the back from left to right Valentin Filatyev, Ivan Anikeev, and Pavel Belyayev. Four cosmonauts were missing from this photograph: Anatoliy Kartashov and Valentin Varlamov had both been dropped from training because of injuries. Valentin Bondarenko died in a training accident a few months before. Vladimir Komarov was indisposed. The original photo was taken by I. Snegirev (files of Asif Siddiqi).

spaceships; there was simply no requirement for significant piloting experience or skill at that point. The candidates had to be intelligent, comfortable with high-stress situations, and most of all physically fit.

In late February 1960, twelve of the twenty selected cosmonaut candidates arrived for final medical tests at the Central Scientific-Research Aviation Hospital. It was there on March 7 that Marshal Vershinin gave a welcome speech, which one witness characterized as "parting words prior to departure on a long, difficult journey."¹² The same day, Kamanin signed final orders officially inducting them into the cosmonaut team and instructing them to return to their Air Force units, settle all pending matters, and then arrive at the new training center. Orders for the remaining eight trainees were signed between March 9 and June 17, 1960, after which all twenty were permanently stationed at the center.¹³ Training classes for the candidates began at 0900 hours Moscow Time on March 14 with an introductory lecture from physician Yazdovskiy. During the initial four months, the training was evenly divided between a heavy emphasis on academic disciplines and general daily physical fitness regimes. The latter included two hours

¹² Gorkov, 'History of the Space Program.'

¹³ The first twelve to officially join the team on March 7, 1960, were Anrkeyev, Bykovskiy, Gagarin, Corbatko, Kornarov, Leonov, Nelyubov, Nikolayev, Popovich, Shonin, Trtov, and Volynov. Khrunov joined on March 9, Zaykin and Filatyev joined on March 25, Belyayev, Bondarenko, Rafikov, and Varlamov joined on April 28, and Kartashov joined on June 17. Their official orders were signed by Commander in Chief of the Soviet Air Force Marshal K. A. Vershinin. See V. Semenov, I. Marinin, and S. Shamsutdinov, *Iz istorii kosmonavtiki: vypusk 1: nabory v otryady kosmonavtov i astronautov* (Moscow: AO Videokosmos, 1995), p. 12.

of intensive calisthenics per day initially conducted at the Central Army Stadium in Moscow. In later months, a dedicated exercise facility was built on the premises of the training center itself. To provide a distinct link between the spacecraft they would be flying and their training, three times a week various engineers from OKB-1 and other leading space firms served as part-time lecturers at the center, teaching classes covering rocket-space systems, space biomedicine, navigation, radio communications, geophysics, and astronomy."

Parachute training, which prepared the cosmonaut-trainees for both emergency and nominal mission events, was commenced on April 13, when most of the pilots were flown to the Saratov region near Engels to begin jumps from a converted An-2 aircraft. Within about six weeks, each had made approximately forty to fifty jumps, and became acclimated to landing on water and land, from high and low altitudes, and in nighttime conditions." At the same time, trainee Bykovskiy became the first individual to undergo a fifteen-day-long test in the TBK-12 anechoic chamber, beginning April 6, to simulate the effects of complete psychological isolation. Other medical testing included the use of the *Khilov* swing to test the vestibular apparatus, the Barani and Rotor rotating armchairs, a low-pressure barometric chamber to simulate altitudes of up to twelve kilometers, a centrifuge capable of inducing up to ten g's, and a thermal chamber to subject the trainees to temperatures up to seventy degrees Centigrade for one or two hours. Regular medical tests were administered before and after each exercise. Not surprisingly, of all the training regimes, the cosmonauts were most resistant to the medical and endurance tests, and it apparently took much convincing for them to agree to subject themselves to the never-ending series. To maintain their piloting skills, the trainees were allowed to fly MiG-15UTI trainer aircraft under the supervision of Mark L. Gallay, one of the most renowned test pilots in the Soviet Union, on loan from the prestigious M. M. Gromov Flight-Research Institute at Zhukovskiy. Under Gallay's direction, the trainees flew parabolic trajectories to simulate microgravity for periods up to thirty seconds in specially equipped Tu-104 aircraft."

Because of the space limitations of the existing facilities for training, the Air Force tasked the staff at the new center to explore the possibility of moving to a location more amenable to the needs of cosmonaut training. Officers initially recommended two potential sites near Moscow: one at Balashikha and the other near the Tsiolkovskiy Railway Station at Shelkovo. After assessing the pros and cons, the Air Force decided to move the entire training program to the latter area because of its isolated location and large area. The proximity to several key facilities, including OKB-1, a large housing complex, the Academy of Sciences, and the Monino airfield were also important factors in the selection. The staff of the training center and the cosmonauts formally relocated to the new location on June 29, 1960.¹⁴ This new suburb of Moscow, about the thirty kilometers northeast of the capital city, was renamed Zelenyy ("Green"). The location is known, however, by its more recent name Zvezdny Gorodok ("Starry Town" or "Star City"), the site where Russian cosmonauts and American astronauts trained during the 1990s and will be training in the early 2000s for flights to the Russian space station *Mir* and the International Space Station.¹⁵

14 In the initial stages lecturers from OKB-1 included K. D. Bushuyev, K. P. Feoktistov, M. K. Tikhonravov, B. V. Raushenbakh, V. I. Sevastyanov, and Ts. V. Solovyev. Biomedicine lectures were initially given by O. C. Cazenko, V. V. Parin, and V. I. Yazdovskiy. See Mozhgorin *et al.* eds. *Dorogi v kosmos II*, p. 150. Colovanov, Korolev, p. 610. A. Yu. Ishlinskiy, ed. *Akademik S. P. Korolev Ucheniy inzhener chelovek* (Moscow: Nauka, 1986), p. 471.

15 Lardier, *L'Astronautique Soviétique*, p. 126. Colovanov, *Korolev*, p. 610. The parachute training was directed by TsPK instructors I. M. Dzyuba, M. I. Maksimov, N. K. Nikitin, A. K. Starikov, and K. D. Tayurskiy.

16 Vladimir Yazdovskiy, "They Were the First," *Aerospace Journal*, no. 2 (March-April 1996): 69-71. Lardier, *L'Astronautique Soviétique*, pp. 122, 126-27.

17 Corkov, "History of the Space Program."

18 The location was renamed Zvezdny Gorodok on October 28, 1968.

As the basic training for the trainees neared completion, a rudimentary spacecraft simulator named the TDK-1, the first of its kind in the Soviet Union, was built at the M. M. Gromov Flight-Research Institute to allow training in various mission modes.¹⁹ Because doctors believed that it would be inefficient to train all twenty men on one simulator at this early phase, Korolev, Karpov, and Kamanin recommended that the center staff select a core group of six pilots who would undergo accelerated training. This group would carry out the first piloted flights, while the remaining fourteen would continue basic training and fly at a later time. Some such as Volynov, who was too broad-shouldered, and Shonin, who was too tall, were not considered for the primary group. Komarov, who was clearly the strongest candidate, being an engineer and a capable pilot, would have been included on the team had it not been for a cardiac anomaly that doctors inadvertently detected during a training exercise. The Air Force eventually drew up a short list of six names on May 30, 1960. Informally titled "The Vanguard Six," they were Gagarin, Kartashov, Nikolayev, Popovich, Titov, and Varlamov. To meet with them, Korolev visited the center for the first time on June 18.²⁰ The cosmonauts had first learned of his existence only three months earlier, although even then he was simply referred to as the "chief designer" to conceal his identity. The Vanguard Six in turn repaid the honor with a visit to the OKB-1 premises the following month, thus for the first time seeing the spacecraft they were destined to fly.

The core group of six cosmonauts suffered their first casualties, both coincidentally in July 1960, soon after moving to the new location at Zelenyy. On July 16, following a centrifuge test of up to eight g's at TsPK, physicians discovered a reddening of trainee Kartashov's spine. Subsequent centrifuge tests confirmed the original diagnosis of hemorrhages, which implied weaknesses in his blood vessels. An otherwise completely healthy person, Kartashov was immediately dropped from the Vanguard Six, although he remained at the center continuing basic training with the other cosmonauts. Despite entreaties from his close friends, such as Titov, Kartashov was eventually dismissed from the team in April 1962 without having been assigned to any missions. Little more than a week after Kartashov's accident, on July 24, a second trainee from the inner six, Varlamov, was involved in a swimming accident at the Medvezhiy Lakes while swimming with two other pilots, Bykovskiy and Shonin. During a dive, Varlamov hit the bottom of the lake with his head and injured his spine. Following diagnosis, he was found to have a displaced cervical vertebra, which disqualified him from further training.²¹ Nelyubov and Bykovskiy, respectively, took the positions of Kartashov and Varlamov. Bykovskiy was apparently favored because of his slight appearance, low weight, and high tolerance for g-loads.²² Thus by the end of July, six men were in line to compete for the grand prize of being the first Soviet citizen in space: Gagarin, Bykovskiy, Nelyubov, Nikolayev, Popovich, and Titov. If all went according to Korolev's plan, one of them would also have the distinction of being the first person in space.

19 The simulator was designed and built by the State Experimental Design Bureau of the Flight Research Institute (SOKB LII) headed by Chief Designer S. C. Darevskiy.

20 Rex Hall, *The Soviet Cosmonaut Team 1956-1967*, *Journal of the British Interplanetary Society* 41 (1988): 107-10. A brief description of this first meeting can be found in Ishlinskiy, ed., *Akademiik S. P. Korolev*, pp. 490-91.

21 Kartashov officially resigned from the cosmonaut team on April 7, 1962, following which he became a test pilot for the Ministry of Defense. He worked for many years at CSOKB 473 of O. K. Antonov before retiring. Varlamov officially resigned from the cosmonaut team on March 6, 1961. After his resignation, he served as a deputy chief of the center's spaceflight control post and later as a chief instructor. He died on October 2, 1980, the result of a brain hemorrhage.

22 Colovanov, *Korolev*, pp. 616-17; Yazdovskiy, *'They Were the First'*.

Korabl-Sputnik

The testing program for the first Soviet piloted spacecraft began in 1960. By that time, the ship was given an actual name: Vostok ("East"). By April, OKB-1 engineers under Bushuyev and Tikhonravov had completed the draft plan for the first version, designated the 1K (or Vostok 1), essentially a "boilerplate" variant for testing the primary spacecraft systems in orbit. Also mentioned in the draft plan were the 2K (Vostok 2) and the 3K (Vostok 3). The former would be the automated reconnaissance satellite, while the latter would be the actual piloted spaceship. There was considerable pressure to accelerate the Vostok 3 schedule, primarily because of the stream of news on Project Mercury. By the early summer of 1960, NASA officials were expecting to fly the first *suborbital* piloted Mercury not before January 1961. This deadline marked an informal target for OKB-1; for Korolev in particular, it was absolutely imperative that the first piloted Vostok be in orbit prior to a *suborbital* Mercury. The "end of 1960" deadline was specified in an official document from the Soviet government, dated June 4, 1960, titled "On a Plan for the Mastery of Cosmic Space"; all testing for a piloted Vostok flight would be completed by December 1960."

The testing program to support the attainment of this goal involved not only launching automated Vostok 1 and Vostok 3 capsules, but also firing a series of short-range missiles into the upper atmosphere to prove out various elements of the life support system and biological support instrumentation. While none of these lobbs into space used the actual Vostok spacecraft, the flights made an important contribution to the progress of the Vostok program as a whole. Most of these launches were announced publicly by the Soviet media as being extensions of the IGY scientific program of 1957-58. Two different types of missiles were used for these experiments, the R-2A and the R-5A, both "scientific" variants of military ballistic missiles. At least five successful biological launches of the R-2A in 1957 were followed by six more from July 1959 to September 1960, all to altitudes of approximately 212 kilometers. Each carried two dogs.²⁴ A more advanced but less intensive program of launches was undertaken by the R-5A, which allowed the time in weightless conditions for the passenger dogs to be doubled. Four launches were carried out between February and October 1958, each carrying two dogs to altitudes of about 470 kilometers, a world record for a single-stage ballistic missile.

The success of the vertical launches of these missiles helped reinforce the confidence in the overall Vostok program. From a political standpoint, however, the piloted project was still in competition with more pressing military goals. Since late 1958, OKB-1 had been concurrently working on the parallel reconnaissance satellite effort designated Zenit. Although initially there was implicit support to emphasize the piloted portion, by early 1960, perhaps prompted by the changing strategic positions between the two superpowers, the Soviet government expressed increased impatience in the timetable for the surveillance project. At a meeting on January 9, 1960, Military-Industrial Commission Chairman Ustinov reminded the leaders of OKB-1 that "there was no goal more important at the present time" than the reconnaissance program.²⁵ The criticism was clearly aimed directly at Korolev's idealistic enthusiasm for piloted spaceflight, and it also underlined the growing rift between civilian and military goals in the Soviet space program. When the Council of Chief Designers had originally decided in late 1958 to bestow a higher priority to Vostok than Zenit, the Ministry of Defense was still

²³ Yu P Semenov ed *Raketno-Kosmicheskaya Korporatsiya "Energiya" imeni S P Koroleva* (Korolev RKK Energiya named after S P Korolev 1996) p 109

²⁴ This second series was inaugurated on July 2, 1959 and ended on September 22, 1960. See George E Wukelic ed *Handbook of Soviet Space Science Research* (New York: Gordon and Breach Science Publishers, 1968) p 17. There were two additional failures in the program out of a total of thirteen launches.

²⁵ B Ye Chertok *Rakety i lyudi: Fili Podlipki Tyuratam* (Moscow: Mashinostroyeniye, 1996) p 319

relatively unsure of the requirement of space-based reconnaissance. That position had drastically changed in less than two years, possibly exacerbated by the launches of the U.S. spy satellite CORONA under the cover-name Discoverer.

The Vostok program as a whole achieved a significant milestone in the early summer of 1960, as the first flight-ready article was transported to Tyura-Tam for launch. Supervising the test program for Vostok was yet another *ad hoc* "State Commission," this one originally established to oversee the series of ongoing R-7A ICBM launches. Marshal Nedelin, the Commander-in-Chief of the Strategic Missile Forces, served as commission chairman, his presence underlining the unbridled influence of the military over a "civilian" project.

The first Vostok 1 article readied for launch was a subvariant designated the 1KP (or Vostok 1P), with the "p" denoting that it was a simple ("prostoy") spacecraft not designed to be recovered from orbit. The spacecraft had no thermal shielding for the spherical descent apparatus and no life support system. Instead of the large ejection seat that would carry a pilot, the spacecraft carried a mock-up of the contraption to simulate the correct loads. Unlike later Vostok spacecraft, two solar panels shaped like semicircles were installed on a boom heading out forward from the descent apparatus. This system, designated *Lueh* ("ray"), would provide power to the spacecraft as an experiment to evaluate the effectiveness of solar power over chemical batteries.²⁶ The primary goal of the mission was to test the basic elements of the vessel, in particular the complex *Chayka* orientation system, which would put the spacecraft in the proper attitude for reentry. Although the vehicle would burn up on reentry, telemetry data would indicate whether the spacecraft had been properly angled. Total spacecraft mass was 4.540 kilograms.

Engineers began arriving at Tyura-Tam on April 28, 1960, in preparation for the flight, which was planned for early May. There were numerous problems with the *Chayka* system that threatened to delay the mission. Engineers delivered a flight-ready system several days late and installed it on the spacecraft only on May 5. Continuing anomalies with the system forced Marshal Nedelin to reschedule the launch on May 15, exactly three years after the first R-7 launch. It was an early morning launch with the Sun shining brightly in the sky when the 8K72 launch vehicle raced toward orbit with its Vostok 1P payload. The vehicle successfully entered a 312- by 369-kilometer orbit at an inclination of sixty-five degrees. As soon as they received news of successful orbital insertion, the senior members of the State Commission gathered to draw up a communique for the Soviet press. There was some indecisiveness over what to call the vehicle in the open media; Korolev livened the discussion by suggesting the use of the word *korabl* (ship): "There are sea ships, river ships, air ships, and now there'll be space ships!" Although the term "space ship" was used for the first time in the official TASS news agency announcement on the mission, the craft itself was simply designated *Korabl-Sputnik* ("satellite-ship"). There was no indication that the mission had any relevance to a piloted space effort.

The flight, planned to last three or four days, proceeded without incident, with successful tests of the electrical and power source systems. Reentry, the most critical juncture of the mission, was scheduled for the early morning of May 19. Prior to the scheduled firing of the TDU-1 engine, the control group at Tyura-Tam (Croup T) had detected anomalies in the primary system of attitude control, which used the infrared sensor. Although the system as a whole seemed to be functioning fine, the sensor itself was not responding correctly. The Tyura-Tam team reported the problem to the control group at Moscow (Croup M), but the designer

²⁶ The solar panel system was designed by the All-Union Scientific-Research Institute of Current Sources (VNIIT) headed by N S Lidorenko. See Lardier *L'Astronautique Soviétique* p 123.

²⁷ Chertok *Rakety i lyudi* p 385. The other attendees were L A Grishin, A Yu Ishlinskiy and M V Keldvsh.

of the system, Boris V. Raushenbakh, refused to agree to Group T's recommendation to use the backup system of orientation. OKB-1 Deputy Chief Designer Boris Ye. Chertok, who was the head of Group T, quickly called a meeting at Tyura-Tam and reached a consensus that the primary system not be used, in favor of the still-operating solar-based *Grif* sensor. He then passed this recommendation on to Moscow. Although it seems that Korolev agreed with Chertok at first, he gave in after persuasive arguments by Keldysh and Raushenbakh to go ahead with the primary system. Unfortunately, on the sixty-fourth orbit, the primary system malfunctioned, and the fourteen thrusters working on compressed nitrogen (ten kilograms thrust each) inserted the spacecraft in the exact wrong attitude. The TDU-1 retrorocket automatically fired on time at 0252 hours Moscow Time, but the spacecraft, instead of reentering the atmosphere, was boosted into a new high orbit of 307 by 690 kilometers. The descent apparatus eventually decayed more than five years later on October 15, 1965. Korolev, indignant at the control error, slapped reprimands on several of his engineers, including Vostok designer Feoktistov."

After a short investigation of the malfunction, OKB-1 opted to remove the infrared system from the Vostok 3A piloted variant of the spacecraft. Those spacecraft would instead be equipped with two systems: a solar-based automatic system and a manual system using Earth's horizon. The second Vostok 1 spacecraft readied for launch, while having the old set of orientation systems, was far more advanced than its modest predecessor; it was equipped with an operational life support system and a means of recovery. Two dogs, Chayka and Lisichka, were trained to fly into orbit on board. Korolev was particularly fond of Lisichka, a feeling that was evidently mutual; the usually calm dog would invariably become animated when Korolev would visit during prelaunch operations. The two dogs were launched on July 28, 1960, but the mission went awry right from the beginning. Just nineteen seconds after launch, the booster began "to fork to one side" as a result of a fire and a breakdown of the combustion chamber in one of the strap-on engines (in Blok G). The inert strap-on broke away from the main vehicle, and the booster eventually exploded into pieces at T+28.5 seconds. Although the descent apparatus separated from the stack, the explosion killed both passengers."

The accident forced serious consideration for testing a launch escape system on the 8K72 booster. Tikhonravov's department, responsible for the design of the spacecraft, proposed a system in late August that would ensure that any on-board cosmonaut would have the capability to abort the mission at four different stages of the ascent to orbit. The first forty seconds of the launch were considered the most dangerous portion, and in the case of a booster malfunction, the pilot would eject from the capsule via a catapult and land separately by parachute.²⁸ The addition of a launch escape system as well as the change in orientation systems were unusual for a program whose flight testing had already begun. The Vostok program indeed had the odd distinction of being perhaps the only piloted space program whose draft

28 Ibid pp 386-87 'The Program of Research Successfully Completed TASS Communique on the Movements of the Korabl Sputnik' (English title) *Pravda* May 21 1960 Ishlinskiy ed Akademik S P Korolev p 513 The burn time of the engine was about twenty six seconds implying that the TDU 1 was shut down before a full burn or it was also the victim of a malfunction

29 Semenov ed *Raketno-Kosmicheskaya Korporatsiya* p 111 Chertok *Rakety i lyudi* p 389 S Shamsutdinov "Sixty Years for Yu A Gagarin" (English title) *Novosti kosmonautiki* 5 (February 26-March 11 1994) 5-7 Timothy Varfolomeyev 'Soviet Rocketry that Conquered Space Part 3 Lunar Launchings for Impact and Photograph' *Spaceflight* 38 (June 1996) 206-08 S P Korolev 'On the State of the Experimental Work on Vostok Ship' (English title) in B V Raushenbakh ed *Materialy po istorii kosmicheskogo korablya 'Vostok'* (Moscow Nauka 1991) pp 136-45 Note that the last source states that the failure occurred on July 23 1960

30 Semenov ed *Raketno-Kosmicheskaya Korporatsiya* p 113 Note that in Korolev's 1961 document summarizing the Korabl Sputnik launches he stated that the system was installed on all Vostok flights following the July 1960 accident which implies that such a system was used on the August 1960 launch See Korolev 'On the State of the Experimental Work' p 136

CHALLENGE TO APOLLO

plan — that is, the technical document specifying its design — continually evolved over the period of the project.³¹ This was no doubt attributable to the time constraints set in part by plans for Project Mercury.

The next Vostok I mission was set to carry two new dogs, Belka and Strelka, into orbit. Along with the dogs, there were numerous other biological specimens. The pressurized cabin contained twelve mice, insects, plants, fungi, cultures, seeds of corn, wheat, peas, onions, microbes, strips of human skin, and other specimens. In addition, there were twenty-eight mice and two white rats outside the ejection seat, but within the descent apparatus. Two internal TV cameras, developed by NII-380, would provide views of the dogs during the spaceflight. The spacecraft itself was fully equipped with a functioning catapult, a life support system, and parachutes. The launch, originally set for August 15, was delayed because of problems with an oxygen valve in the booster, but the dogs were finally sent on their way with a successful launch at 11:44 hours 6 seconds Moscow Time on August 19. Upon successfully entering its 306- by 339-kilometer orbit at 64.96-degree inclination, the spacecraft was named the "Second Korabl-Sputnik." Total mass in orbit was about 4,600 kilograms. News of the launch was immediately relayed to the Hall of Columns during the minutes when judges were considering the sentence for American Francis Gary Powers, who was shot down by a Soviet 5-75 missile system in May of the previous year.

Throughout the one-day mission, doctors continuously monitored the medical condition of the dogs while various parameters of the life support system were given a rigorous workout. Because there were two cameras aboard the spacecraft, Yazdovskiy's biomedical support group was able to observe the reactions of the dogs while in flight. The pictures coming back were not encouraging. Initially, the dogs appeared deathly still, and without the incoming data stream on their life signs, it would have been impossible to tell if they were alive or not. Later they became more animated, but their movements seemed convulsive. Belka squirmed and finally vomited on the fourth orbit. Yazdovskiy silently watched the video and gloomily reported to the State Commission that a flight with a cosmonaut be limited to one orbit and no longer. There were simply too many unknowns about the effects of weightlessness on the human organism.³² A number of scientific experiments were carried out during the mission, including those for the detection of cosmic rays and the monitoring of high-energy emissions in the ultraviolet and x-ray wave lengths.

Telemetry showed that the infrared orientation system had failed once again. After a busy night verifying its capabilities, engineers recommended using the backup solar orientation system. The latter system performed without any anomalies on the spacecraft's eighteenth orbit, and the descent apparatus successfully entered Earth's atmosphere at the correct angle. The catapult system operated on schedule and ejected the cabin with the dogs in the mock-up of the ejection seat. The cabin landed safely by parachute only ten kilometers from the designated point of touchdown in the Orsk region in Kazakhstan after a one-day, two-hour spaceflight. Belka and Strelka thus became the first living beings recovered from orbit. The spacecraft itself was only the second object retrieved from orbit; the American Discoverer 13 had preempted Korabl-Sputnik 2 by nine days.³³ Doctors found both dogs in good condition despite the

31 The draft plan for the Vostok 3A spacecraft (the piloted variant) was officially completed on July 31 1961 well after the first piloted orbital spaceflight

32 Colovanov, *Korolev* p. 622

33 Discover 13 was a CORONA reconnaissance satellite diagnostic mission without on board cameras. Note also that one source suggests that the descent apparatus of the Korabl-Sputnik 2 spacecraft landed as much as 200 kilometers from its target site. See Mozhorin *et al.* eds. *Dorogi v kosmos II* p. 46

concerns during the mission. Extensive physiological tests proved that there had been no fundamental changes in their health.

This particular flight of the Vostok I spaceship was a watershed moment and verified almost all the primary elements of the spacecraft design. Korolev returned to Moscow on August 28 to hear reports from Deputy Chief Designer Bushuyev and Group Chief Feoktistov on the progress of the design of the Vostok 3A piloted variant. Very satisfied with the work done. Korolev, in coordination with the other leading chief designers involved in the program (Glushko. Ryazanskiy. Pilyugin. Barmin, Kuznetsov. Bogomolov. Isayev, Kosberg, Alekseyev. and Yazdovskiy), prepared a document titled "Basic Status of the Development and Preparation of the Object 3KA (The Piloted Space Ship 'Vostok-3A')," which included listings and descriptions of all the major systems on the spaceship as well as a cyclogram for a nominal flight with contingency plans for all possible failures.³⁴

The importance of the document, dated September 7, 1960, was not so much for its technical details, but because of the remarkable concern for safety of the pilot that comes through in each section of the report. One section is completely devoted to enumerating the redundancies and safety measures for each of the spacecraft's major systems, from the critical orientation systems to the tiny pyrotechnical cartridges on the ejection hatch. Finally, in what must have been Korolev's personal touch, the authors emphasized that previous management practices in the missile industry would no longer hold for the Vostok project because failure was an unacceptable outcome. The complete Vostok system consisted of a six-unit three-stage launch vehicle with as many as thirty-three thermally, statically, and dynamically loaded systems, such as turbopumps, for the rocket engines. The spacecraft itself consisted of 241 vacuum tubes, more than 6,000 transistors, fifty-six electric motors, and about 800 relays and switches interconnected by about fifteen kilometers of cable, in addition to 880 plug connectors having up to 850 contacts *per* connector. Clearly, the entire system could not be regarded as failure-proof. Here Korolev used his managerial technique to emphasize to each chief designer, plant director, and military operations manager that the life of a cosmonaut depended on his or her part of the work. The chain of responsibility was delegated down to the lowest ranked worker in the assembly shop. The eleven signatories of the document indirectly represented 123 organizations, including thirty-six plants, that were participating in the project."

The preparation of this document proved to be the catalyst for a state-level intervention in the program. Three days later, on September 10, the ten most powerful leaders in the Soviet defense industry (led by Ustinov) and the armed forces, along with the six original core members of the Council of Chief Designers, signed and sent a document on the Vostok program to the Central Committee of the Communist Party. Declassified finally in 1991, the letter for the first time formally set a timetable for accomplishing the first piloted spaceflight. It began:

The successful launch, space flight, and landing of the spacecraft (the object "Vostok-1") sheds new light on the dates for performing a piloted flight into cosmic space. An analy-

34 This document has been reproduced in its entirety as 5 P Korolev V P Glushko M S Ryazanskiy N A Pilyugin V P Barmin V I Kuznetsov A F Bogomolov A M Isayev S A Kosberg S M Alekseyev and V I Yazdovskiy 'Basic Status of the Development and Preparation of the Object 3KA (The Piloted Space Ship Vostok 3A) (English title) in Raushenbakh ed *Materialy po istorii kosmicheskogo* pp 125-28

35 Raushenbakh ed *Materialy po istorii kosmicheskogo* p 213 There was also another document titled 'Regulations for the 3KA' which was issued in December 1960 and specified production and design responsibilities for each chief designer plant director and so on See Semenov ed *Raketno Kosmicheskaya Korporatsiya* p 565

*sis of the telemetric measurement data received during the flights of the "Vostok-I" suggests the possibility of creating normal living conditions for a human during space flight.*³⁶

The authors recommended that one or two further Vostok I flights be carried out in October–November 1960, followed by two automated missions of the Vostok 3A variant in November–December 1960. By December 1, the cosmonauts training for their mission would be ready, and a full-scale piloted flight could be accomplished in a Vostok 3A in December, in time to beat a Mercury launch. Unlike all earlier Soviet space projects, the fact that this document was signed by ministerial heads rather than the standard deputy ministers clearly underlines the importance with which the Soviet leadership viewed the program. If in 1959 there was some hesitation on the part of the government to fully commit to a piloted space program, by the end of 1960, those concerns had no doubt been overridden by the imminent threat of Project Mercury. Having consistently taken the lead in the early space race, the Soviet Union was forced to make efforts to continuously maintain that preeminence. Despite the national priority in strategic missiles, space had become an arena not only for military applications but also simply national pride. In a sense, the chest-beating self-congratulatory euphoria that had followed the launches of Sputniks and Lunas pushed the Soviet government into maintaining the image of the new advanced Soviet state. It was a race that they had started and were in no position to call off.

The petition by the sixteen leaders of the Soviet space program was received in the Central Committee of the Communist Party—that is, by Nikita S. Khrushchev and Froi R. Kozlov. Both approved the plan and issued a top-secret reply dated October 11, listing each of the ministerial jurisdictions of the signatories:

1. The proposal of the USSR Council of Ministers State Committee of Defense Technology, the USSR Council of Ministers State Committee on Radio-Electronics, the USSR Ministry of Defense, the USSR Council of Ministers State Committee for Ship Building, the USSR Council of Ministers State Committee for Aviation Technology, and the USSR Academy of Sciences, which has been examined and approved by the Commission of the Presidium of the USSR Council of Ministers for Military-Industrial Issues, on the preparation and launch of a spacecraft (the object "Vostok-3A") with a man on board in December of 1960, is approved, because it is a task of great importance."

Thus the stage was set for the launch of the first human into space in the last month of 1960. It was an ambitious timetable. There was no precedent for the rapid pace of the schedule—OKB-I had managed to conduct three launch attempts in three months in the summer of 1960, and that rate would have to be almost doubled. The decision was clearly made after

36 An edited version of this letter was published in V Belyanov L Moshkov Yu Murin N Sobolev A Stepanov and B Stroganov "Yuriy Gagarin's Star Voyage Documents from the First Flight of a Human into Space" (English title) *Izvestiya TsK KPSS* 5 (1991) 101–29. The signatories to the document were (in order of their signatures) D F Ustinov (Chairman of the Military Industrial Commission) R Ya Malinovskiy (Minister of Defense) K N Rudnev (Chairman of the State Committee for Defense Technology) V D Kalmykov (Chairman of the State Committee for Radio Electronics) P V Dementyev (Chairman of the State Committee for Aviation Technology) B Ye Butoma (Chairman of the State Committee for Ship Building) M I Nedelin (Commander in Chief of the Strategic Missile Forces) S I Rudenko (Deputy Commander in Chief of the Air Force) V M Ryabikov (Deputy Chairman of the RSFSR Council of Ministers) M V Keldysh (Vice President of the USSR Academy of Sciences) S P Korolev (Chief Designer of OKB I) V P Clushko (Chief Designer of OKB 456) M S Ryazanskiy (Chief Designer and Director of NII 885) N A Pilyugin (Chief Designer of NII 885) V P Barmin (Chief Designer of GSKB SpetsMash) and V I Kuznetsov (Chief Designer of NII 944).

37 This decree of the Central Committee of the Communist Party and the USSR Council of Ministers has been reproduced in full in *ibid* p 103. The title of the document was "On the Object Vostok 3A."

exhaustive discussion, and there is no evidence to suggest that Korolev would have approved such a timetable if he did not think it was realistic. The plans of the Soviet government were, however, suddenly and tragically thwarted by one of the worst-ever disasters in the history of rocketry, a dark reminder of the perils of the new technology at its disposal.

Disaster and Delays

On the evening of October 24, Korolev called OKB-1 senior engineer Arkadiy I. Ostashev into his office to give him some important information. The chief designer had just received a call from Tyura-Tam on restricted communications lines from his Deputy Yevgeniy V. Shabarov concerning a major accident at the launch range in which Ostashev's older brother, Yevgeniy, had been involved.³⁸ Still unaware of the scale of the accident, Korolev immediately permitted the younger Ostashev to fly to the launch site. The magnitude and catastrophic nature of the accident only became clear to Korolev through the night as more and more reports arrived from both Tyura-Tam and indirect sources in Moscow. The disaster was beyond the comprehension of even the most darkest nightmares, and it involved a rocket designed not by Korolev, but by his rival, Chief Designer Yangel.

Offering up stiff competition to Korolev to design a new generation of ICBMs, Yangel had brought his first offering, the R-16, to the launch pad in mid-October for its first launch. After the relative failure of Korolev's R-7 as an operational ICBM, there was a tremendous amount of import focused on bringing Yangel's new R-16 to operational status. It would finally give the Soviet Union an active and large-scale strategic deterrent backing up the Khrushchev's bluster and bragging about Soviet might. Days before the planned launch, the Soviet leader, in a speech at the United Nations, had boldly stated that strategic rockets were being produced in the Soviet Union "like sausages from a machine," a claim that was clearly not true in the case of ICBMs.³⁹ Numerous important officials were at Tyura-Tam to witness the first launch, including Strategic Missile Forces Commander-in-Chief Nedelin, who also chaired the State Commission for the R-16.

Fueled by storable, hypergolic, and highly toxic propellants, there had been much difficulty prior to launch, especially in fueling procedures, which caused great consternation at the site. The first launch was originally set for October 23, but a major propellant leak that evening forced a postponement to the next day. On the orders of the State Commission, all repairs to the missile were carried out in a fully fueled state, creating a remarkably dangerous situation at the pad. The repairs were successfully completed through the night, and all prelaunch operations proceeded as planned until thirty minutes prior to the set launch time on October 24. At this point, there were still approximately 200 officers, engineers, and soldiers near the pad, including Marshal Nedelin, who scoffed at suggestions that he leave the pad area. "What's there to be afraid of? Am I not an officer?" he was reported to have asked.⁴⁰ By a fateful stroke of luck, Yangel himself was convinced to enter a safe bunker to smoke a last cigarette by Maj. General Aleksandr G. Mrykin, Nedelin's point man for missiles and space. Mrykin was apparently thinking of quitting smoking, and he had decided to smoke his last cigarette right then. It was at that moment, exactly thirty minutes prior to the scheduled launch, that the missile suddenly exploded on the pad, releasing an expanding inferno of destruction around the pad area.

³⁸ Chertok *Rakety i lyudi* p 396

³⁹ Steven Zaloga *Target America: The Soviet Union and the Strategic Arms Race 1945-1964* (Novato CA: Presidio, 1993) p 195

⁴⁰ S. Averkov "Top Secret: Explosion at Baykonur Cosmodrome. Only After 30 Years Are We Learning the Truth About the Death of Marshal Nedelin and a Large Croup of Rocket Specialists" (English title) *Rabochaya tribuna* December 6, 1990 p 4



This still from a film of the R-16 explosion shows the expanding fireball around the missile as pad workers desperately tried to flee the scene of the catastrophe. Approximately 130 people perished as a result of the explosion, many of whom were identified only by medals on their jackets or rings on their fingers.
(copyright Rudy Inc. via Quest magazine)

Within seconds, the rocket broke in half and fell on the pad, crushing any one who might have still been left alive. At that point, the fire and the heat increased in intensity as all the propellants ignited in a crescendo. Some people were simply engulfed in the fire, while others who managed to run in a burning state succumbed to the toxic gases within minutes. Technicians remained hanging from their harness from special cranes as their bodies burned. Deputy Chairman of the State Committee of Defense Technology Lev A. Grishin, who had been standing next to Nedelin, managed to jump over a high railing, run across the molten tarmac, and jump to the high gate of the ramp from a height of three and a half meters, breaking both legs in the process to reach safety. Tragically, he succumbed to his burns soon after he was taken to the hospital." As the temperature raged to around 3,000 degrees, people just simply melted in the firestorm, many being reduced to ashes.

Through the ensuing days, workers began the gruesome task of identifying bodies. A special commission headed by Yangel was formed immediately to investigate the accident. The failure had evidently occurred when the second stage of the R-16 had spuriously started firing on the pad because of a control system failure, thus igniting the propellants in the first stage. This control system, developed by the Kharkov-based OKB-692, had lacked a circuit to block spurious commands from reaching the second stage. It took fourteen hours of torment before the

41 Grishin was still alive four days after the disaster on October 28. At the time, his injuries were listed as "2nd, 3rd, and 4th degree burns on the face, head, neck, left half of the thorax. Open fracture in both bones of right and left shins. Left lower extremity amputated from the middle third of the shin."

young Ostashev identified his brother. Nedelin himself was identified only by his Gold Star medal attached to his uniform. OKB-692 Chief Designer Boris M. Konoplev, the talented guidance systems engineer who was among the rising stars in the Soviet missile and space program, was identified by his height, having been one of the tallest men at the pad. All told, 126 individuals died in the blast, including senior military officials, deputy chief designers, and numerous soldiers.⁴² The entire incident was kept under tight wraps, and Marshal Nedelin was said to have died in an aircraft accident, a piece of fiction that the Soviets officially maintained until early 1989. The prohibition on discussing the disaster among the survivors was not lifted until 1990, thirty years following the tragedy.⁴³

The R-16 disaster was a devastating blow to the Soviet missile program. Although it did not have any direct connection to the piloted space effort, there was clearly a repercussive delay on the Vostok program. Many of the same design organizations, such as OKB-456 (Glushko), NII-944 (Kuznetsov), NII-88 (Tyulin), and NII-229 (Tabakov), had major contributions to both the R-16 and Vostok projects. Marshal Nedelin, apart from his role as Commander-in-Chief of the Strategic Missile Forces, had also chaired several important State Commissions, including Vostok, thus capping his fifteen-year-long role as one of the most important figures in the growth of the Soviet missile and space programs. Kirill S. Moskalenko, the fifty-eight-year-old Commander of the Moscow Military District, was brought in as the new commander of the Strategic Missile Forces. He had the unusual distinction of being one of the men to participate in NKVD Chairman Beriya's execution in December 1953. Konstantin N. Rudnev, forty-nine, the industrial leader of the space and missile program, took Nedelin's place as the chair of the State Commission for Vostok.⁴⁴ It was the peak of Rudnev's ten-year rise to influence as one of the top industrial managers in the Soviet Union. His first job in the rocketry effort had been as director of the famous NII-88 in the early 1950s.

It would be more than two weeks following the R-16 disaster that active work on the Vostok effort resumed again. By this time, it was clear that the original schedule for a piloted flight in December 1960 was unrealistic. In a letter dated November 10, Ustinov, Keldysh, Korolev, Rudnev, and Moskalenko asked the Central Committee for formal permission to launch two Vostok 1 precursor craft prior to commencing testing of the piloted Vostok 3A variant.⁴⁵ In the best-case scenario, a first piloted flight could not be carried out before late February 1961. By this time, NASA was also looking at the first suborbital flight in early spring. Thus, despite the delays associated with the R-16 disaster and other technical problems, there was still a slim margin of safety in the new schedule.

42 Chertok *Rakety i lyudi* p. 397. There are still many discrepancies in reports of the final human toll of the R-16 disaster, ranging from a lower limit of ninety-two to an upper limit of 165. By October 28, seventy-four people had been identified as dead. A number of previously classified important documents related to the disaster were published in 1994. These included the original communique sent by Yangel to Moscow minutes after the disaster, a preliminary accident report by the technical commission on the day after the accident, and lists of those who had been identified (both deceased and injured) by October 28. See I. D. Sergeyev, ed., *Khronika osnovnykh sobytiy istorii raketnykh voysk strategicheskogo naznacheniya* (Moscow: TsPK, 1994), pp. 240-63.

43 There are numerous Russian language sources that describe the incident. The ones primarily used in the above narrative were: Averkov, "Top Secret: Explosion at Baykonur Cosmodrome," Col. A. Radionov, "The Time Has Come to Tell: It Happened at Baykonur at the First Launch of the New Rocket: How Marshal Nedelin Died: The Memory of the Living" (English title), *Krasnaya zvezda*, October 24, 1990, p. 2; A. Bolotin, "Site Ten" (English title), *Ogonek* 16 (April 15-22, 1989), 10-14. For a recent English language account of the R-16 disaster, see Asif A. Siddiqi, "Mourning Star," *quest* 3 (Winter 1994), 38-47.

44 Zaloga, *Target America*, p. 99; Chertok, *Rakety i lyudi*, p. 411.

45 This letter is reproduced in full, but with disguised designations, as D. F. Ustinov, M. V. Keldysh, S. P. Korolev, K. N. Rudnev, and K. S. Moskalenko, "On Launches of the Vostok A Korabl Sputnik" (English title), in V. S. Avduyevskiy and T. M. Eneyev, eds., *M. V. Keldysh: izbrannyye trudy raketnaya tekhnika i kosmonavtika* (Moscow: Nauka, 1988), pp. 355-56.

Permission to launch the two Vostok I spacecraft, the fourth and fifth in the series, was granted almost immediately by the Central Committee, which allowed processing at the OKB-I plant and at Tyura-Tam to pick up speed. Both spacecraft were identical to the ship launched in August, save for the omission of the infrared orientation system that had been the source of so many problems on the previous missions.⁴⁶ The first one was launched without incident on December 1, 1960, into an orbit exactly mimicking the one planned at the time for an actual piloted mission: 180 by 249 kilometers at a 64.95-degree inclination. Aboard the satellite, called the Third Korabl-Sputnik in the Soviet press, were two dogs. Pchelka and Mushka. Total mass in orbit was 4,563 kilograms. There was apparently improved biomedical instrumentation on board, as well as a different set of instruments for cosmic and radiation studies.

The flight went well, and there were twelve successful communications sessions for telemetry reception. After about twenty-four hours in orbit, on the seventeenth orbit, the main TDU-I engine was to fire to initiate reentry. Unfortunately, there was a malfunction in the stabilization system of the engine: the resulting firing was far shorter than had been planned. Although the spacecraft would still reenter, computations showed that the landing would overshoot Soviet territory. The spacecraft made one and a half more orbits, after which the descent apparatus with the dogs separated from the rest of the vehicle. An additional communications session with the craft confirmed the failure of the TDU-I. At this point, a special and unusual system was called into operation—one that was installed to address this precise situation. During earlier mission planning, there had been much concern about the possibility of having a spacecraft land off course and on "foreign territory." Given the extreme secrecy and xenophobia of the missile and space programs, the only option for designers was to install a self-destruct system aboard the vehicle to destroy the "evidence" before recovery by non-Soviet parties. Designed by NII-137, the system for the emergency explosion of the object was designed to detonate if the on-board g-sensor did not detect reentry at the assigned moment. Mercifully, such a system was only earmarked for the Vostok precursor missions and not for any actual piloted craft. In the case of Korabl-Sputnik 3, the system went into operation at the beginning of reentry and destroyed the spacecraft along with its hapless passengers." At the time, the Soviet press merely announced that because of the incorrect attitude, the descent apparatus had burned up on reentry.

The problem with TDU-I was identified quickly by "adopting means for ensuring normal work of the Braking Engine Unit." and the next Vostok I spacecraft was brought to the launch pad at site 1 in the third week of December. There was a slight change in the booster-spacecraft stack for this flight. All earlier Korabl-Sputnik missions had used the 8K72 launch vehicle also used for the Luna launches. This particular flight would be the first to use a slightly modified variant designated the 8K72K, which substituted the RD-0109 (just over five and a half tons) for the RD-0105 (just over five tons) as the third orbital insertion stage.⁴⁸ The nominally increased thrust would allow a slightly higher mass planned for the piloted variant. Thus, the fifth Vostok I spacecraft, carrying the dogs Kometa and Shutka, was sent on its way at 1045 hours Moscow Time on December 22, 1960.⁴⁹ The first two stages of the 8K72K booster

⁴⁶ Korolev 'On the State of the Experimental Work'

⁴⁷ Ibrd Chertok *Rakety i lyudi* pp 411-12 Although the system was not used on any piloted Vostok mission, it was standard on all variants of the Vostok spacecraft for reconnaissance missions

⁴⁸ Varfolomeyev "Soviet Rocketry that Conquered Space Part 3" The first tests of the 8K72K variant may have occurred earlier. There were two suborbital launches related to the R 7 (or R-7A) on July 5 and 7, 1960, during which the payloads were deposited in the Pacific. See Lardier *L'Astronautique Soviétique* p 122. A Chronology of *Missile and Astronautical Events* prepared for the Committee on Science and Astronautics, US House of Representatives, 87th Cong, 1st sess (Washington, DC: US Government Printing Office, March 1961) p 119.

⁴⁹ N. P. Kamanin *Skrytiy kosmos kniga pervaya 1960-1963gg* (Moscow: Infortekst IF, 1995) p 9. Note that this source suggests that the names of the dogs were Zhemchuzhnaya and Zhulka.

performed without fault, but the new third stage engine prematurely cut off at T+425 seconds because of the destruction of the gas generator in the engine. The emergency escape system went into operation, and the spacecraft successfully separated as its flight trajectory described an arc across the Soviet Union. The payload reached an altitude of 214 kilometers and landed about 3,500 kilometers downrange from the launch site in one of the most remote and inaccessible areas of Siberia, in the region of the Podkamennaya Tunguska River close to the impact point of the famed Tunguska meteorite. By the late hours of December 22, rescue forces began to detect signals from the descent apparatus, and a search party led by Korolev's old friend, Arvid V. Pallo, was dispatched to try and locate the capsule.

The rescue mission turned out to be one of the most harrowing episodes of the time. Once the rescue group was dropped at the general area of the landing site two days late on December 24, Pallo and his associates found themselves in waist-deep snow. By having aircraft fly in the direction of the object, they managed to reach the capsule. Once the team found the spacecraft, they had to approach it with extreme care because the emergency explosive system was to automatically detonate the vehicle sixty hours after landing. By the time they reached the spacecraft, it had already been sixty hours, but the capsule had still not exploded, forcing them to disengage the explosive in minus-forty-degree Centigrade temperatures. They later discovered that the cabling in the explosive system had burned through, neutralizing the bomb. Although both hatches on the descent apparatus had been discarded, the ejection seat had remained within the spherical capsule instead of ejecting out with the dogs. Later investigation showed that during ejection, the seat had slammed into the side of the exit porthole and remained within the spacecraft. Pallo and his deputy returned to the site the next day, and the dogs were finally taken out of the capsule, a little cold but alive, and flown to safety, arriving in Moscow on December 26. Bringing the descent apparatus itself back to Moscow proved to be much more difficult as they used a variety of strategies to literally drag the capsule through kilometers of snow. At one point, Pallo's team had to terminate all rescue operations and spend the night in the middle of the ice and snow when the temperature dropped to minus sixty-two degrees Centigrade. It was the first week of January 1961 before the vehicle finally arrived in Moscow.⁵⁰ Despite Korolev's entreaties that the failure be announced in the Soviet press, the State Commission vetoed the idea.

An analysis of the launch abort on December 22 showed that there were a number of major anomalies on the mission. Following the booster third-stage failure, the Vostok 1 craft was to separate into its component descent apparatus and instrument section modules. This never happened. The two capsules severed their connections only because of the thermal heating on reentering the atmosphere. Furthermore, the ejection seat was to have shot out of the capsule two and a half seconds after the hatch was jettisoned: on this mission, both events occurred simultaneously, causing the craft to deform from the shock of the failed ejection.⁵¹ Then there was the fortuitous failure in the self-destruct system. All of these, for obvious reasons, were not encouraging. The Korabl-Sputnik program now had two major failures in a row. The State Commission's provisional date of February 1961 for a piloted flight was no longer viable. At a meeting of the commission on January 5, 1961, Deputy Chief Designer Bushuyev laid out a schedule for the forthcoming months. As per earlier plans, the next two launches in the series were to be automated flights of the actual piloted variant, the Vostok 3A. The first would fly on February 5 and the second on February 15-20." Contingent upon their successes, the commission would approve a piloted mission.

50 Mozzhorin *et al.* eds. *Dorogi v kosmos II* pp. 47-51. M. Rebrov. 'But Things Were Like That—Top Secret: The Painful Fortune of the N1 Project' (English title) *Krasnaya Zvezda* January 13, 1990, p. 4.

51 Kamanin *Skrytyi kosmos* p. 10.

52 *Ibid.* p. 11.

The Road to Vostok

The training of the core group of six cosmonaut-trainees selected as a pool for the first piloted mission reached a turning point in January 1961. By that time, all six had finished final regimes in simulators lasting three days, as well as full-scale parachute and recovery training. Over two days in mid-January, the six—Captain Bykovskiy, Lieutenant Gagarin, Lieutenant Nelyubov, Captain Nikolayev, Captain Popovich, and Lieutenant Titov—took their final exams to assess their degree of readiness. A special interdepartmental commission under Lt. General Kamanin's supervision would review the results of the tests and recommend the most likely candidates for the very first mission.⁵³ On January 17, each candidate spent forty to fifty minutes in a simulator at the M. M. Gromov Flight-Research Institute describing the operation of the spacecraft, its instruments, and various phases of a mission, after which the members of the commission asked specific questions. Particular attention was devoted to the operation of the TDU-1 engine and spacecraft orientation, both of which had failed at various times in the previous Korabl-Sputnik missions. On the first day, Nikolayev, Popovich, Gagarin, and Titov received grades of "excellent," while Bykovskiy and Nelyubov were given "very good" scores. The following day, the candidates took a written exam, which completed the program. The results were collated soon after, and the commission recommended the following order for using the trainees in flights: Gagarin, Titov, Nelyubov, Nikolayev, Bykovskiy, Popovich.⁵⁴ This particular series of tests helped narrow down the pool of cosmonauts for the first mission to the three best candidates: Gagarin, Titov, and Nelyubov. Although *nontechnical* factors such as psychological characteristics and ideological issues would narrow the three men down to one for the very first mission, all three would travel to Tyura-Tam in a few months.

Even at this early stage, the twenty-six-year-old Yuriy Gagarin seemed to be the clear favorite. He had come from working-class origins in the Smolensk region west of Moscow, graduating from secondary school in 1949. He spent the following few years in various technical institutes before joining the Orenburg Higher Air Force School in 1955. Until his selection as a cosmonaut-trainee, he had served as an active duty pilot at Zapolyarniy, north of the Arctic Circle. By all accounts, he was a very likable and intelligent individual, and he had fortuitously made an extremely favorable impression on Korolev the first time the cosmonauts had met the chief designer in mid-1960. Although there has been a tendency to hero-worship the young man, even those less prone to hyperbole had nothing but positive things to say about him. Cosmonaut Khrunov later remembered that:

Gagarin was extraordinarily focused, and when necessary, very demanding of himself and of others. Which is why I think that concentrating on that famous smile of his might miss the mark entirely and might even diminish the image of who he really was."

53 The members of the commission were Maj General A. N. Babiychuk (Chief of the Soviet Air Force Medical Service), Lt. General V. Ya. Klovov (Institute of Aviation and Space Medicine), V. I. Yazdovskiy (Institute of Aviation and Space Medicine), Colonel Ye. A. Karpov (Director of TsPK), Academician N. M. Sisakyan (Department of Biological Sciences of the USSR Academy of Sciences), K. P. Feoktistov (OKB 1), S. M. Alekseyev (Chief Designer of Plant No. 918), and M. L. Gallay (test pilot at the M. M. Gromov Flight Research Institute). In addition, Flight Research Institute Director N. S. Stroyev was present during the tests. See Kamanin, *Skrytiy kosmos*, p. 12; L. N. Kamanin, "A Minute's Readiness Has Been Announced" (English title), *Znaniya* no. 4 (April 1989), 134-46.

54 The remaining eleven active cosmonauts—Anikeyev, Belyayev, Filat'yev, Corbatko, Khrunov, Komarov, Leonov, Rafikov, Shonin, Volynov, and Zaykin—took their test on April 4, 1961. Out of a total possible of "5," Komarov and Leonov received 5+, Anikeyev, Filat'yev, Shonin, and Volynov received 5, and Belyayev, Corbatko, Khrunov, and Rafikov received 4. See Golovanov, *Korolev*, p. 633.

55 *Ibid.*, pp. 628-29.

OKB-1 engineer Raushenbakh recalls that "Gagarin would never try to ingratiate himself, nor was he ever insolent. He was born with an innate sense of tact." In an early evaluation of his personality dating from August 1960, when he was simply one of twenty men in training for a flight, a commission of Air Force doctors wrote with remarkable unambiguity of Gagarin's positive attributes:

[M]odest; embarrasses when his humor gets a little too racy; high degree of intellectual development evident in Yuriy; fantastic memory; distinguishes himself from his colleagues by his sharp and far-ranging sense of attention to his surroundings, a well-developed imagination; quick reactions; persevering, prepares himself painstakingly for his activities and training exercises; handles celestial mechanics and mathematical formulae with ease as well as excels in higher mathematics: does not feel constrained when he has to defend his point of view if he considers himself right; appears that he understands life better than a lot of his friends."

When the cosmonaut group had carried out an informal and anonymous survey to see whom among the cosmonaut group they would like to see fly first, all but three of the twenty named Gagarin. Apart from his high qualifications, he also satisfied the Communist Party's unwritten criterion that the first Soviet person in space be from a completely Russian and working-class background.

German Titov, twenty-five years old at the time, had grown up in the Kosikhinskiy District in Altay Territory before entering the Kacha Higher Air Force School in 1953. Following his graduation in 1957, he served as an active duty pilot in the Leningrad District. He struck many as being the most worldly and well read of the six, and he was noted for rebelling against what he called "silly questions" during the selection processes in 1959." The youngest of the six, he had performed excellently and without problems throughout the past year in training and was a close competitor of Gagarin. The last of the three, the twenty-six-year-old Grigoriy Nelyubov, was perhaps the most talented and qualified of the group of six. Raised in Crimea, he had graduated from the Yeisk Higher Air Force School in 1957 and served as a MiG-19 pilot with the Black Sea Fleet. Soon after selection as a cosmonaut, he had consistently demonstrated his expertise as one of the top members of the group of twenty. He also had influential supporters at OKB-1: Department Chief Raushenbakh was said to have supported Nelyubov's candidacy to be the first Soviet person in space. On the negative side, Nelyubov was also extremely outspoken and individualistic. For Air Force overseer Kamanin, a diehard old-school Stalinist, Nelyubov's otherwise remarkable record in training was neutralized by his direct and critical nature. Gagarin, who was "quiet in character," was a far more suitable candidate from an ideological perspective."

In terms of preparing for the first Vostok mission, the training of cosmonauts was only the tip of the iceberg of a mammoth undertaking. Tracking requirements for a piloted mission were a lot more stringent than for the modest Sputniks in the years before, and the military NII-4 institute was once again tasked with coordinating the establishment of a network to support the new project. The original seven communications points spread out across the Soviet Union (at Tyura-Tam, Makat, Sary-Shagan, Yeniseysk, Iskhup, Yelizovo, and Klyuchi) to support the early satellite program were augmented by six new stations (at Leningrad, Simferopol, Tbilis,

56 *lbrd* p 629

57 Rex Hall, "Soviet Air Force Cosmonauts" in Cassutt, ed *Whos Who in Space* p 266

58 *lbrd* p 251; Golovanov *Korolev* p 630

Kolpashevo, Ulan-Ude, and Moscow)." Although the Soviet Union stretched close to two and a half times more in width than the contiguous United States, there were clear limitations to monitoring space missions from a single landmass, especially given the heightened requirements of a piloted mission. Perhaps reluctant to negotiate treaties as NASA did to station tracking points on foreign soil, the Soviets instead resorted to fully equipped self-contained naval vessels stationed all over the world. The first generation of Soviet overseas tracking ships—*Sibir*, *Suchan*, *Sakhalin*, and *Chukotka*—were stationed originally to monitor ICBM nose cone impacts and later for mission-critical events of the *Korabl-Sputniks*. These ships were commissioned as part of the officially named Pacific Ocean Hydrographic Expedition No. 4. These were augmented in August 1960 by a newer second generation stationed in the Atlantic that were built specifically for the Vostok, lunar, and Interplanetary programs: *Dolinsk*, *Ilichevsk*, and *Krasnodar*. The duration of communications contact between each surface point and the orbiting spacecraft was limited to five to ten minutes, with an altitude envelope reaching out to 1,500 to 2,000 kilometers.⁵⁹

For the early piloted space missions, NASA opted to use a control center at the launch site at Cape Canaveral. While the Soviets maintained such a control point at Tyura-Tam, the nerve center for all the early piloted Soviet spaceflights was in the Bolshevo suburb of Moscow at the premises of the military NII-4. It was here that the so-called Command-Measurement Complex Center was located, under direct control of the Strategic Missile Forces. The center was staffed primarily with officers from NII-4 and headed from July 1959 by Colonel Andrey G. Karas, a veteran of the early Kapustin Yar launches. Ballistics and computational support during missions were provided by three different computation centers, each with its own operations group—one at NII-4 and two in the Academy of Sciences. Although Karas was nominally the head of the entire Command-Measurement Complex, the day-to-day technical operations were handled by Colonel Amos A. Bolshoy, a military scientist who would play a prominent role in controlling all early Soviet piloted missions by providing the State Commission with recommendations on mission-critical events.⁶¹ The fact that this position, roughly analogous to the Western concept of a flight director, was occupied by a colonel in the Strategic Missile Forces was merely another symptom of the outgrowth of the Soviet space program from the ballistic missile effort. This was one of the reasons that until the 1970s, the Soviets steadfastly refused to identify the location of its primary control center for the early piloted space program. Apart from command and control, the Soviet Air Force accepted the burden of organizing recovery forces for landing cosmonauts. The huge armada consisted of twenty-five aircraft (twenty Il-4s, three An-12s, and two Tu-95s) as well as ten helicopters. In addition, seven separate parachute teams were established to quickly reach a returned cosmonaut to provide firsthand medical support.⁶²

59. Yu. A. Mozzhorin, et al., eds., *Nachalo kosmicheskoy ery. vospominaniya veteranov raketno-kosmicheskoy tekhniki i kosmonavtiki* (Moscow: RNITsKD, 1994), p. 272. Each of these centers was called a Scientific-Measurement Point (NIP), and each had a separate number: NIP-1 (Tyura-Tam), NIP-2 (Makat), NIP-4 (Yeniseysk), NIP-5 (abandoned in 1958), NIP-6 (Yelizovo), NIP-7 (Tyura-Tam), NIP-8 (not built), NIP-9 (Leningrad), NIP-10 (Simferopol), NIP-12 (Kolpashevo), NIP-13 (Ulan-Ude), and NIP-14 (Moscow).

60. *Ibid.* pp. 265, 272–73. See also B. A. Pokrovskiy, *Kosmos nachinayetsya na zemlye* (Moscow: Patriot, 1996), pp. 341, 345–46. A fourth ship to the "second generation," *Aksay*, was added in September 1962. See also Lardier, *L'Astronautique Soviétique*, pp. 122–23.

61. Bolshoy was replaced by P. A. Agadzhanov in the mid-1960s. See Pokrovskiy, *Kosmos nachinayetsya na zemlye*, pp. 239, 365, "On the Scientific-Technical Activities of Yu. A. Mozzhorin (On the 70th Year of His Birth)" (English title), *Iz istorii aviatsii i kosmonavtiki* 60 (1990): 4–11.

62. Lardier, *L'Astronautique Soviétique*, p. 123; Kamanin, *Skrytyy kosmos*, p. 39. There were also apparently three Il-18 teams headed by V. M. Pekin, M. A. Chernovskiy, and G. P. Perminov. Among the physicians who were part of the parachute teams was B. B. Yegorov, later to be the first physician in space. The commander of the search and rescue service was Air Force Lt. General A. I. Kutasin.

Through January and February 1961, there were intensive preparations for the launches of the remaining two Vostok precursor missions. Each of these spacecraft would be identical to the actual piloted variant, save for the fact that each would carry a single dog into orbit. A life-size mannequin would be strapped into the main ejection seat, while the dog would be put in a container separate from the ejection mechanism. Unlike the previous dog flights, the missions were to last a single orbit—that is, exactly the same as planned for the first human flight. The preparations leading up to a piloted launch were not smooth by any means. At a meeting of the State Commission presided by Rudnev on February 22, schedules were laid down for the two preliminary missions. The first Vostok 3A with a mannequin would be launched in the first days of March *prior to* completion of ground testing and the elimination of all defects in the model: the second Vostok 3A would reach orbit only after full-scale ground testing was completed. The problems with the first spacecraft were limited to anomalies in the life support and ejection systems, certainly important elements for a biological satellite." At a meeting on February 27, Chief Designers Semyon A. Alekseyev (Plant No. 918) and Grigoriy I. Voronin (OKB-124), responsible for the ejection mechanism and life support systems, respectively, approved a detailed plan for testing these systems for the second Vostok 3A spacecraft. In particular, Voronin had introduced a new air conditioning system, which had to undergo a complete thirteen-day test to simulate the contingency of having a cosmonaut in orbit for that length of time in case of retrorocket failure.

On March 2, OKB-1 Group Chief Feoktistov and his assistant Oleg G. Makarov, both destined to be cosmonauts themselves in later years, prepared a detailed set of instructions for the pilot of the first mission, which included courses of actions for various stages of the mission as well as a number of different emergency situations. The two engineers took provisions to include instructions for manually altering the attitude of the spacecraft in orbit and conducting a completely manual retrofire, both of which were not planned for execution during a nominal mission. The finished document was passed on to Korolev, Keldysh, Bushuyev, and Voskresenskiy, who all significantly shortened the list, arguing that during the first mission, the pilot should not actively control any instrument on the spaceship. A vigorous fight was put up by Kamanin, test pilot Gallay, and physician Yazdovskiy, who argued that the cosmonauts were extremely well trained and could be expected to perform any assigned tasks without problem. In the end, after a long discussion with Academician Keldysh on the merits of human control of a space vehicle, Korolev and the others backed down, and the original lengthy set of instructions was formally approved. Although the first cosmonaut would have the choice of manually controlling certain systems, all members of the State Commission were in agreement that the activities of the pilot should be as conservative as possible. The only concession to scientific research was the inclusion of dry seeds, *drosophila*, and lysogenic bacteria as part of the payload for biomedical studies."

In early March 1961, several leading designers and high-ranking Strategic Missile Forces officials left Moscow for the city of Leninsk near Tyura-Tam to direct the preparations for the two upcoming automated missions." A total of thirty to forty days would be spent during this period at the launch site to test every system of the third spacecraft, the one that would carry a human, and its launch vehicle. By this point, the first Vostok 3A was scheduled for March 9, and the second for late March at the earliest. The pressure was building on the Soviets as Project Mercury seemed to be close to a piloted launch. The option to launch the first Vostok 3A with-

63 Kamanin, *Skrytiy kosmos*, p. 21.

64 *Ibid.* p. 23. Wukelic, *Handbook of Soviet Space-Science Research*, p. 54

65 K. Isaakov, "Breakthrough into the Unknown: Today is Cosmonautics Day" (English title), *Bakinskiy rabochiy*, April 12, 1988, p. 3. The town of Zarya next to the Tyura-Tam launch site was renamed Leninsk on January 28, 1958. See Ivan Borisenko and Alexander Romanov *Where All Roads Lead to Space Begin* (Moscow: Progress Publishers, 1982), p. 22.

out the benefit of full-scale ground testing was clear evidence that OKB-I was not only trying to keep up with its own timetable, but aiming to outrun its chief rival thousands of kilometers away. Back in the United States, in mid-February, NASA's Space Task Group had recommended moving ahead with a suborbital piloted mission on the next Mercury-Redstone attempt. In a last-minute move that seems pivotal in retrospect, Wernher von Braun, on the advice of his booster specialists, argued that an additional automated Redstone flight was necessary before certification for a human launch. Von Braun's recommendation was accepted, thus pushing the first launch of an astronaut from April 25 to early May.⁶⁶

For Korolev, whose decades-old competition with von Braun was only exceeded by his intense urge to be first, this window proved propitious. Korolev proposed to First Secretary Khrushchev that the first piloted mission could be launched in late April to coincide with the celebrations for May Day. The Soviet leader was, however, categorically against timing such a major space mission with a national holiday, no doubt concerned about the possibility of a catastrophic failure. Instead, Khrushchev asked Korolev to move the launch either forward or backward. Thus, the option was clear: the chief designer informally set the first piloted Vostok launch for mid-April. In a curious twist, Khrushchev himself announced on March 14 during an interview widely reported in the West: "The time is not far off when the first (Soviet) spaceship with a man on board will soar into space."⁶⁷

The first human-rated Vostok 3A spacecraft lifted off successfully at 0929 hours Moscow Time on March 9, 1961, and entered a 183 5- by 248.8-kilometer orbit inclined at 64.93 degrees to the equator. The spacecraft was called the Fourth Korabl-Sputnik in the Soviet press. A small pressurized sphere in the spacecraft carried the dog Chernushka ("Blackie") together with forty white and forty black mice, several guinea pigs, reptiles, plant seeds, human blood samples, human cancer cells, micro-organisms, bacteria, and fermentation samples. Unlike the previous dog flights, the main ejection seat was taken up by a life-sized mannequin (Ivan Ivanovich) fully dressed in a functional SK-I *Sokol* spacesuit. Additional mice, guinea pigs, microbes, and other biological specimens were placed in the mannequin's chest, stomach, thighs, and other parts of the "body." This virtual menagerie of animals and plants was the subject of intensive biomedical experimentation during the single orbit flight. An unnamed designer of the Vostok later revealed an interesting aside to the mission:

[T]he main purpose was to ensure reception of voice transmissions from [the ship]. We rejected a numerical countdown, fearing Western radio stations would monitor the human voice and raise a clamor throughout the world alleging that Russia has secretly put a man into orbit. A song also aroused objections because it would be said in the West that "the Russian" cosmonaut had lost his head and started singing! It was then decided to tape a popular Piatnitsky Russian choir, and when the dummy, clothed for purposes of decency in a white smock, suddenly sang like a choir, it was very funny."

In rehearsal for the exact sequence of events on an actual piloted flight, the retrorocket TDU-I engine fired on time for just under forty-two and a half seconds. Almost ten seconds later, the instrument section separated from the descent apparatus, the latter making a ballistic reentry into the atmosphere. The mannequin was safely ejected out of the descent apparatus

66 David Baker *The History of Manned Spaceflight* (New York: Crown Publishers, 1985) p. 65

67 *The New York Times*, March 15, 1961, p. 8; Sergey Khrushchev, *Nikita Khrushchev: krizisy i rakety* (view from inside), vol. 2 (Moscow: Novosti, 1994) p. 97

68 Mozzhorin et al., eds., *Dorogr v kosmos II*, pp. 141-42

69 R. F. Gibbons and P. S. Clark, "The Evolution of the Vostok and Voskhod Programmes," *Journal of the British Interplanetary Society* 38 (1985): 3-10

after reentry, while the main capsule with the dog landed separately by parachute. The mission had lasted only one hour, forty-six minutes. The two objects from the spacecraft settled down about 260 kilometers northeast of Kuybyshev in the middle of a large open field covered by snow. There was apparently some delay in having an OKB-1 representative get to the main capsule to neutralize the self-destruct system. The rescue team led by Lt. General Kamanin elected to take the dog out of the capsule before the arrival of the OKB-1 expert to prevent the dog from freezing to death."

The unequivocal success of Korabl-Sputnik 4 was a clear boost to the fortunes of the Vostok program, which had lacked a completely trouble-free mission since August 1960. The euphoria over the flight was, however, marred to some extent by a tragedy that struck the cosmonaut team in the most unexpected of ways. On March 23, just two days before the launch of the last Vostok 3A precursor, cosmonaut-trainee Bondarenko was on the tenth day of a fifteen-day exercise in an isolation chamber at the premises of the Institute of Aviation and Space Medicine in Moscow. The chamber contained 50 percent oxygen at a reduced pressure to simulate the atmosphere of a spaceship, and it was completely soundproof to test the effects of isolation. Upon completion of some medical tests at the conclusion of his isolation period. Bondarenko removed the sensors attached to his body and with a cotton-wool pad soaked in alcohol cleaned the places where they had been attached. Without looking, he threw the cotton pad away, and the latter landed on the ring of a live electric hotplate. It immediately caught on fire, and the flame blazed up in the oxygen-rich atmosphere. At first, instead of ringing the alarm. Bondarenko tried to put the fire out himself, but his woolen training suit caught fire. The doctor on duty, Mikhail A. Novikov, tried to open the door as soon as he became aware of the fire, but this operation took several minutes, by which time Bondarenko was completely burnt. As he was dragged out of the chamber, he reportedly kept repeating. "It was my fault, no one else is to blame."

The chief physician at the nearby hospital where Bondarenko was taken recalled later that the cosmonaut's "body was totally denuded of skin, the head of hair; there were no eyes in the face—everything had been burnt away. It was a total burn of the severest degree." Bondarenko finally died at 1500 hours Moscow Time on March 23, eight hours following the accident, of shock resulting from burns. It was the very first death of a space trainee in the history of the space program. Just twenty-four years of age and the youngest trainee on the team, he was buried in his birthplace of Kharkov, where his parents lived. His wife Anya and their son Sasha remained behind at Zelenyy, supported by a special pension as a result of a direct order from Minister of Defense Marshal Rodion Ya. Malinovskiy." News of the accident was completely suppressed in the interest of morale, especially considering that the first piloted Vostok mission was then scheduled in less than three weeks. It is not clear whether any of the other cosmonaut-trainees were told about the tragedy at the time, or several weeks later. As it happened, the accident or even the existence of Bondarenko was not revealed until 1986 as part of a series of articles in the newspaper *Izvestiya* celebrating the twenty-fifth anniversary of the first piloted Vostok mission.

Preparations for the last precursor mission continued with the Bondarenko tragedy firmly in mind. The six core cosmonauts flew to Tyura-Tam on March 17 to witness the prelaunch operations of the next Korabl-Sputnik, where they engaged in some last-minute training

70 Kamanin, *Skrytiy kosmos*, pp. 25–26.

71 *Ibid.*, pp. 33–34; Yaroslav Colovanov. "Cosmonaut No. 1: Slander" (English title). *Izvestiya*, April 3, 1986, p. 6. Colovanov, *Korolev*, p. 633.

72 Vladimir Colyakovsky, *Russian Doctor* (New York: St. Martin's/Marek, 1984), p. 130

73 Colovanov. "Cosmonaut No. 1: Slander" The order was signed on May 15, 1961, and included the following: "Furnish the family of First Lt. Bondarenko with everything they need, as befits the family of a cosmonaut"

exercises. The trainees completed a variety of tests, including a question-and-answer problem session with Korolev. There was a minor delay of the launch because of a problem with the on-board communications apparatus, but this proved to be unimportant. Launch operations were also halted briefly because of a failure in a sensor on the third stage of the booster, and on orders from Chief Designer Kosberg, workers rapidly replaced the unit. Prior to launch, controllers conducted communications tests between the blockhouse near the pad and the spacecraft to simulate conditions on a crewed mission. Kamanin, Korolev, and cosmonaut trainee Popovich took turns testing the system. Popovich had been assigned to serve as the prime communicator during the launch, analogous to the "capcom" role in the U.S. space program.⁷⁴

The spacecraft, named the Fifth Korabl-Sputnik in the Soviet press, was successfully launched at 0854 hours Moscow Time on March 25, just two days after Bondarenko's death. The 4,695-kilogram vehicle carried another coterie of animals and biological samples, including the dog Zvezdochka ("Starlet") on a single-orbit mission. Orbital parameters were 178.1 by 247 kilometers at a 64.9-degree inclination, close to what was slated for the piloted flight. The mission was uneventful, and all reentry procedures were conducted without problems. As with several of the previous missions, the recovery of the animals and the mannequin was delayed by bad weather. The descent apparatus and the ejection seat landed during a heavy snowstorm, causing difficulties in locating the exact touchdown point. By the time that a group of engineers from Plant No. 918 reached the site, it had been twenty-four hours since the landing. After several hours traveling on horse-drawn sleighs over the one-and-a-half-meter-deep snow, the rescuers finally reached the descent apparatus with the dog, and they eventually found the mannequin in a nearby forest. The neighboring villagers were apparently very suspicious of the recovery teams, suspecting that they might do some harm to the "man" that had landed by parachute. The villagers finally retreated when they were shown conclusive proof that the "man" was indeed just a mannequin." Academy of Sciences Vice-President Aleksandr V. Topchiyev summarized the results of the five successful Korabl-Sputniks in a press conference in Moscow on March 28. In attendance were not only Soviet and foreign journalists, but also Gagarin, Titov, and other cosmonauts in the front row of the audience. No one, of course, had any knowledge that one of them was slated to fly in a spacecraft within days.⁷⁵

The safe landing of Korabl-Sputnik 5 effectively cleared the way for the launch of the first piloted Vostok spacecraft. For Korolev and Tikhonravov, this would be the apex of their long careers in rocketry, which began thirty years before with the amateur GIRD team in a basement in Moscow. In a fitting move, Korolev invited some of the original GIRD veterans to his offices at Kaliningrad in March 1961, a month prior to the first scheduled piloted launch. It was a surprise reunion for the guests, punctuated by much reminiscing, although they had little idea of Korolev's real work because of its classified nature. Near the end of the conversation, Korolev, speaking of the fruitful work at GIRD, added that "now we have come very far!" He invited the guests to a nearby assembly shop. Nikolay I. Yefremov, one of the GIRD veterans, later described the trip:

When we walked into the spacious, well-lit shop, we immediately saw our long time dream. Sergey Paulouich [Korolev] introduced it, literally introduced it as if it were a living thing, the beautiful rocket. Off to the side, on a special pedestal, we saw the cockpit of the spacecraft prepared for manned flight. It was the "Vostok" spacecraft."

74. Kamanin. *Skrytiy kosmos*. pp. 29–33, 34–35.

75. "Vostok Program, 1961–1963," *Russian Space History* (New York: Sotheby's, 1993), description for lot 11.

76. Colovanov. *Korolev*. p. 625.

77. Ishlinskiy, ed.. *Akademiik S P Korolev*. pp. 164–65

Even in the hectic days leading to the first Vostok flight, a link was underlined between the pioneering work in the 1930s and the Soviet space program of the 1960s. After thirty years of postulating and hypothesizing, the reality of human spaceflight was only a few days away.

Gagarin in Orbit

After the Korabl-Sputnik 5 mission, Korolev returned to Moscow on the evening of March 28. The following afternoon at a meeting of the State Commission presided over by Chairman Rudnev, Korolev presented the results of the complete Vostok program and declared readiness to launch a human into orbit on the next Vostok 3A spacecraft.⁷⁸ Later in the evening, the leading members of the State Commission met once again to draw up a formal document requesting permission from the Communist Party to launch a human into space. For the first time, a high-ranking official from the Committee for State Security (KGB), its First Deputy Chairman, Petr I. Ivashutin, was present.⁷⁹ The memorandum, addressed to the Central Committee and classified "Absolutely Secret," began:

In accordance with the decree of the Central Committee of the KPSS and the USSR Council of Ministers of 11 October 1960 on the preparation and launch of a space ship with a human, all the necessary work on ensuring human flight into cosmic space has been finished at the present time. . . . Two "Vostok-3A" satellite-ships have been prepared for this purpose. The first ship is at the [launch] range, and the second is being prepared for launch. Six cosmonauts are prepared for the flight. The satellite-ship with a human on board will be launched for one orbit around the Earth and will land on the territory of the Soviet Union on a line running through Rostov-Kuybyshev-Perm."

A section of the document detailed contingency procedures in the case of unforeseen events:

For the orbit chosen for the satellite-ship, in the event that the ship's system for landing on the Earth fails, the ship can descend by natural breaking in the atmosphere over the course of 2-7 days, with a touchdown between latitudes of 65° north and south. In the event of a forced landing in foreign territory or the rescue of the cosmonaut by a foreign ship, the cosmonaut has appropriate instructions. In addition to a ten day supply of food and water, the cosmonaut's cabin is outfitted with a portable emergency supply of food and water that will last for 3 days, and also means of radio-communications and the "Peleng" transmitter whose signals can be used to determine the landing site of the cosmonaut. The satellite-ship is not equipped with a system for emergency destruction of the Descent Apparatus."

The issue of installing a self-destruct system on the ship was discussed at length during the meeting. All those present, with the sole exception of KGB representative Ivashutin, strongly opposed including such a system on a piloted vehicle. Ivashutin only backed down when all

⁷⁸ The document presented by Korolev is the previously referenced 'On the State of the Experimental Work'. A second document titled "The Orientation System of the Vostok Satellite Ship" was also signed by Korolev on the same day. This document has also been reproduced in Raushenbakh, ed. *Materialy po istorii kosmicheskogo* pp. 133-35.

⁷⁹ According to Kamanin, *Skrytiy kosmos* pp. 38-39, those present at this meeting were: S. P. Korolev (Chief Designer of OKB 1), G. I. Voronin (Chief Designer of OKB 124), S. M. Alekseyev (Chief Designer of Plant No. 918), L. I. Gusev (Director of NII-695), M. V. Keldysh (Vice President of the USSR Academy of Sciences), P. I. Ivashutin (First Deputy Chairman of the KGB), S. I. Rudenko (First Deputy Commander in Chief of the Soviet Air Force), and N. P. Kamanin (Deputy Chief of the Air Force General Staff for Combat Preparations).

⁸⁰ This document has been reproduced in full in Belyanov, et al., "Yuriy Gagarin's Star Voyage" pp. 103-04, 81. *Ibid.* p. 104.

the other members refused to go along.⁸² The State Commission also took pains to carefully detail the manner of publicity given to the mission by the Soviet media. There was no attempt by the members to obfuscate or lie about a potential failure, despite the almost paranoid secrecy of the space program. Every attempt was made to give precedence to the safety of the cosmonaut over other political considerations, such as having to admit failure:

We consider it advisable to publish the first TASS report immediately after the satellite-ship enters orbit for the following reasons:

- (a) if a rescue becomes necessary, it will facilitate rapid organization of a rescue;*
- (b) it precludes any foreign government declaring that the cosmonaut is a spy with military goals.*

If the satellite-ship does not enter orbit because of insufficient speed, it can land in the ocean. In that case, we also consider it advisable to publish the TASS report, so as to facilitate rescue of the cosmonaut.⁸³

There had also been discussion for some time on what to actually call the spaceship in the open press. One side proposed retaining the Korabl-Sputnik name for the mission, merely listing it as the next in the series—that is, the Sixth Korabl-Sputnik. It was Tikhonravov who passionately argued that such a momentous mission not be referred to by such a generic designation. Instead, he proposed disclosing the top-secret "Vostok" name in the TASS report.⁸⁴ Korolev agreed, and the State Commission ratified this position. The memorandum from the State Commission for Launch ended with the following: "We request permission to launch the first Soviet satellite-ship with a human on board and approval for the preparation of planning the TASS communiqués."⁸⁵ The flight was set between April 10 and 20, 1961. The document was signed by Military-Industrial Commission Chairman Ustinov, State Commission Chairman Rudnev, defense industry "ministers" Kalmykov, Dementyev, and Butoma, Academician Keldysh, Strategic Missile Forces Commander Moskalenko, Air Force Commander Vershinin, Air Force representative Kamanin, KGB representative Ivashutin, and Chief Designer Korolev.⁸⁶

82. Kamanin, *Skrytiy kosmos*, p. 39.

83. Belyanov, et al., "Yuriy Gagarin's Star Voyage," pp. 104–05.

84. Mikhail Rebrov, "Was This Just a Tragicomedy?" (English title), *Krasnaya zvezda*, June 1995.

85. Belyanov, et al., "Yuriy Gagarin's Star Voyage," p. 105.

86. Note that K. N. Rudnev was also the chair of the State Committee for Defense Technology, the "ministry" overseeing the ballistic missile and space programs. V. D. Kalmykov was the chair of the State Committee for Radio-Electronics, P. V. Dementyev was the chair of the State Committee for Aviation Technology, and B. Ye. Butoma was the chair of the State Committee for Ship-Building. It is apparent from the list that some important changes had been made since the original decree on Vostok in October 1960. Marshal Moskalenko had taken the place of the deceased Marshal Nedelin as Commander-in-Chief of the Strategic Missile Forces, thus maintaining a high-level representation from the old artillery lobby. The Air Force had gained in strength with two members on the commission. Air Force Deputy Commander-in-Chief Marshal Rudenko was replaced in favor of Commander-in-Chief Marshal Vershinin and Lt. General Kamanin. Rudenko was, however, still closely involved in preparations for the flight, but the importance of the mission perhaps necessitated the inclusion of Vershinin. Kamanin's "promotion" is noteworthy in retrospect for it hints at his rapidly rising influence. For obvious reasons of security, KGB representative Ivashutin had been added to the commission, and this underscores the importance with which the Communist Party viewed the project. The notable omissions from the core group from October 1960 were Soviet Minister of Defense Malinovskiy, former Sputnik State Commission Chairman Ryabikov, and the rest of the Council of Chief Designers. Malinovskiy probably relinquished his role to Moskalenko and Vershinin. The omission of Ryabikov is somewhat puzzling because he had been involved in the missile and space programs since 1946, rising to the very powerful position of chair of the so-called Special Committee by 1955, thus overseeing even his former boss Ustinov. With alliances in the defense industry continually changing, it seems that Ryabikov's road to power had reached a plateau by 1960. At the time of the first Vostok mission, he was the chair of the Council of National Economy of the Russian Soviet Federated Socialist Republic, certainly a "demotion" from his previous roles in the defense industry.

The memorandum was formally addressed to the Central Committee of the Communist Party, which on paper was composed of a very large group of individuals. In practice, however, especially in the case of such a high-priority project, only two individuals were involved in the final go-ahead: Nikita S. Khrushchev and Frol R. Kozlov. The latter had inherited the top Communist Party position for the space, missile, and defense sectors in the Secretariat in July 1960.⁸⁷ From then on, as the member of the Party "cabinet" responsible for important policy decisions on the space program, Kozlov only had one person who could overrule his word. As the new Secretary of the Central Committee for defense and space, he helped define and reinforce a position that had been handled unevenly at best by his predecessor Leonid Brezhnev, who after Kozlov's promotion found himself in a largely ceremonial post.

On April 3, three days following receipt of the State Commission memorandum, the following "Strictly Secret" decree titled "On the Launch of the Space Satellite-Ship" was issued by the Presidium (later the Politburo) of the Central Committee:

1. *The proposal of Ustinov, Rudnev, Kalmykov, Demytyev, Butoma, Moskalenko, Vershinin, Keldysh, Ivashutin, and Korolev on the launch of a satellite-ship "Vostok-3A" with a cosmonaut aboard is approved.*
2. *The plans for TASS to announce the launch of the space ship with a cosmonaut aboard an Earth satellite is approved, and grants the Commission for Launch the right, if necessary, to introduce updates on the results of the launch and the Commission of the Presidium of the USSR Council of Ministers for Military-Industrial Issues, the right to publicize it.*⁸⁸

The actual TASS communiques were authored by the military NII-4 under the supervision of institute Deputy Director Colonel Yuriy A. Mozzhorin. The preparation of the news report was a strangely surreal process, as remembered by Mozzhorin years later:

*In order not to lose time for writing and transmitting the necessary texts of the communiques to radio and television, these communiques were prepared at our institute, with the agreement of S. P. Korolev and the leadership, and sent in advance to radio, television, and TASS in sealed envelopes. In the case that [the cosmonaut] successfully entered orbit, they would receive a signal authorizing them to open them, and write down the orbital parameters [which would be communicated] by telephone, and the information would then be publicized internationally. There were also two more packets of material with the above [envelope] . . . with . . . communiques for unfortunate [outcomes]. [The first one was] brief—in the event of death of the cosmonaut during insertion into orbit or at liftoff. The second one was in case of not having reached orbit, but having landed in some foreign territory or in the equatorial regions of the world's oceans. This contained an appeal to all governments, in particular the government on whose territory the cosmonaut had landed, requesting them to render assistance for [his] search and return.*⁸⁹

87 Michael Tatu *Power in the Kremlin From Khrushchev's Decline to Collective Leadership* (London Collins 1969) pp 88-89 Note that Kozlov's appointment into the Secretariat was announced on May 5 1960 although his predecessor Brezhnev was not formally released from his prior duties until July 1960

88 Belyanov *et al* "Yuriy Gagarin's Star Voyage" p 105 Note the curious omission of Kamanin's name from the Communist Party decree although he was a signatory to the original request The Commission of the Presidium of the USSR Council of Ministers for Military Industrial Issues was more commonly known as the Military Industrial Commission (VPK)

89 Mozzhorin *et al* eds *Nachalo kosmicheskoy ery* p 276

The official Communist Party approval for the launch may have been the last *de facto* step in getting a human into space, but technical problems with the Vostok spaceship continued to thwart the possibility of a launch on time. On March 24, OKB-124, responsible for the life support system, reported at a meeting of the State Commission that there were serious limitations in the air drying units of the Vostok 3A spaceship. Long-duration tests on location at the Institute of Aviation and Space Medicine had proved that impregnated lignin in the system began to leak after absorbing a certain amount of moisture, resulting in large amounts of brine forming inside the spacecraft. At a second meeting on March 28, OKB-124 Chief Designer Voronin vehemently defended his system, claiming that the lithium chloride would be harmless to the cosmonaut. A competitive proposal by institute doctor Abram M. Genin to use a newer drying system on the vehicle was the subject of much debate."

The problem with the life support system remained unresolved when Korolev flew into Tyura-Tam from Moscow late on April 3. The six core cosmonauts arrived on the afternoon of April 5 as part of a group of three chartered Il-14 airplanes, followed by State Commission Chairmen Rudnev the following day. Leaving behind their wives back in Moscow, the cosmonauts were instructed to tell their spouses that the launch was set for April 14, three days later than actually intended—to reduce worry. The first meeting of the full State Commission at Tyura-Tam took place immediately after Rudnev's arrival, at 1130 hours Moscow Time, at which point the primary issue of discussion was the life support system and the results of additional testing of the spacesuit and ejection system. Chief Designer Voronin reported, somewhat unconvincingly, that the suspect drying unit was completely ready for a contingency ten-day mission. Because an actual nominal flight was to last only an hour and a half, concerns were somewhat allayed: there would simply not be enough time for brine to form in the spacecraft." The commission also approved cosmonaut trainer Mark L. Gally's proposal to have the cosmonaut candidates conduct training sessions in the actual flight-ready spacecraft rather than a backup one. These tests were carried out on April 7 without incident by Gagarin and Titov, by then the primary contenders for the flight. Nelyubov, the third candidate, was considered out of the running.

The State Commission conclusively addressed the question of who would fly the first mission at a meeting on April 8. Lt. General Kamanin, as overseer of the cosmonaut team, clearly had a major role in the selection. Both Gagarin and Titov had performed without fault during training, with Gagarin edging out Titov in the January 1961 examinations. Although Gagarin was a marginal favorite, Kamanin apparently began to lean toward Titov in the final days leading up to the launch. On April 5, he wrote in his personal journal:

Both are excellent candidates, but in the last few days I hear more and more people speak out in favor of Titov and my personal confidence in him is growing too. . . . The only thing that keeps me from picking [Titov] is the need to have the stronger person for a [second] one day flight."

While Kamanin himself may have been a key player in the selection, there has been much speculation in the West that the final choice was in fact made by "higher ups," as one would expect in a highly centralized society such as the Soviet Union. Days before the scheduled launch, photographs and biographies of Gagarin and Titov were evidently sent to the Defense

90. Karnanin, *Skrytiy kosmos*, pp. 34–38; Yu. A. Mozzhorin *et al.*, eds., *Dorogi u kosmos*. I (Moscow: MAI, 1992), pp. 61–62.

91. Golovanov, Korolev, p. 637; Kamanin, *Skrytiy kosmos*, pp. 43–45; Neville Kidger, "Yuri Gagarin's Immortal Day," *Spaceflight* 33 (April 1991): 124–29.

92. Karnanin, *Skrytiy kosmos*, pp. 44–45; Bart Hendrickx, "The Karnanin Diaries 1960–1963," *Journal of the British Interplanetary Society* 50 (January 1997): 33–40.

Department of the Central Committee, the curator of the space program. Each candidate had two photos, one in civilian clothing and one in military attire. Here a number of Party apparatchiks mulled over their files and reported to Ivan D. Serbin, the feared head of the Defense Department. Serbin then showed the photographs to Kozlov, who in turn showed them to Khrushchev. Upon seeing the photos, the Soviet leader was reported to have said. "Both pairs are excellent! Let them decide for themselves!"⁹³ A noted Russian aerospace historian, Yaroslav K. Golovanov, suggests that the only reason such a convoluted procedure was carried out was simply to allow the Party apparatchiks to be able to say that the decision had been made at the "highest level."

In the end, at the State Commission meeting on April 8, Kamanin stood up and formally nominated Gagarin as the primary pilot and Titov as his backup. Without much discussion, the commission approved the proposal and moved on to other last-minute logistical issues. It was assumed that in the event Gagarin developed health problems prior to liftoff, Titov would take his place, with Nelyubov acting as his backup. The launch date was limited at the meeting to April 11 or 12. Orbital parameters would be 180 by 230 kilometers, and the mission would last a single orbit. There was some discussion on the idea of registering the mission as an absolute world record. In the interest of maintaining the ever-pervasive secrecy, some members of the commission, in particular Moskalenko and Keldysh, opposed having sports commissioners involved. In the end, the commission decided not to disclose the launch site or the type of launch vehicle, but to file documents with international organizations to establish a world record. Although the mission would be completely automated, commission members proposed giving the codes to unlock the manual orientation system for reentry in an envelope to the cosmonaut. In case of a failure of the automatic system, the cosmonaut would open the sealed envelope and activate the manual system." The meeting ended with a decision to hold a last session, more as a formality, two days later.

The following day, Kamanin invited Gagarin and Titov privately to his office and announced to them that Gagarin was going to fly and that Titov would serve as his backup. When asked years later how he felt, Titov replied, "Why even ask! Painful or not—it was at least unpleasant."⁹⁴ The two men relaxed the rest of the day as prelaunch procedures for the 8K72K booster continued at the Assembly-Testing Building. Remarkably, Korolev and his principal deputies Mishin and Chertok were at the same time involved in the first critical launch of the new R-9 ICBM from nearby site 51. It was an extremely high-priority program for not only OKB-1 itself but also the Soviet Union as a whole, and one wonders how hectic operations at Tyura-Tam must have been during this second week of April 1961.⁹⁵ The first R-9 launch took place on April 9, just three days prior to Gagarin's slated launch from site 1.

The following day at 1100 hours, a large meeting of the State Commission took place at a site overlooking the banks of the majestic Syrdarya River. This session was simply a formality, primarily for the Soviet press, but it was open to many curious workers who had not yet had a glimpse of the cosmonauts. In attendance were seventy people, including chief designers (such as Korolev, Clushko, Pilyugin, Barmin, Ryazanskiy, Kuznetsov, Isayev, Kosberg, Alekseyev, Voronin, Bykov, and Bogomolov), ministers, Air Force officers, Strategic Missile Forces officers, and representatives from the Communist Party and the Academy of Sciences, as well as the six core cosmonauts. Chief Designer Korolev, State Commission Chairman Rudnev, Strategic

93 Golovanov *Korolev* pp 634-35

94 *Ibid* p 638 Kamanin *Skrytiy kosmos* pp 46-47 Lardier *L'Astronautique Soviétique* p 129

95 Golovanov *Korolev* p 638

96 Vassily Mishin "He Would Make You Work to the Best of Your Ability" *Aerospace Journal* no 6 (November-December 1996) 76-78 Chertok *Rakety i lyudi* pp 432-33

Missile Forces Commander Moskalenko, and Cosmonaut Training Center Director Karpov all made short but dramatic presentations on the impending mission, followed by thank-you speeches by Gagarin, Titov, and Nelyubov. At the end, Kamanin singled out Gagarin to become the first human to go into space. The young cosmonaut gave an acceptance speech, which was cut short in the middle when a movie cameraman let it be known that his film had inadvertently run out. Gagarin repeated his entire speech so that it could be recorded again.⁹⁷ Earlier in the morning, the 8K72K booster had been moved to the pad at site 1. The launch was set for the morning of April 12, 1961. Engineers had calculated the exact launch time, 0907 hours Moscow Time, because it would afford the best solar illumination for the orientation system's sensors somewhere over Africa right before retrofire.

The day before the launch, OKB-1 engineers Raushenbakh and Feoktistov briefed Gagarin and Titov for an hour and a half on various mission events. Raushenbakh recalled later that he was still having trouble coming to terms with the magnitude of what was going on:

I looked at [Gagarin] and in my mind I understood that tomorrow this kid was going to awaken the whole world. But at the same time I just could not make myself believe that tomorrow something would happen which the world had not yet seen—that this First Lieutenant sitting in front of us would tomorrow become the symbol of a new epoch. I would start giving him instructions, such as, "Turn this on, don't forget to switch this on."—all these normal, pedestrian, even boring remarks, and then I would become silent and some sort of internal imp would begin whispering to me. "This is all a bunch of crap. You know that nothing of this sort is going to happen tomorrow."⁹⁸

Being at the center of everything, the cosmonauts were perhaps less conscious of their centrality in this vortex of events. Witnesses remember Gagarin smiling the whole day, happy that he had been chosen for the mission. The cosmonauts also visited the pad to meet the young soldiers, officers, and sergeants who had worked on the rocket the past few days. It was a pragmatic managerial move—one that not only lifted morale among the lower rank workers, but also played a role in instilling a sense of responsibility, both among the cosmonauts and the work teams. Gagarin and Titov were assigned to a special cottage near the pad area, which had previously been the late Marshal Nedelin's place of choice to stay at Tyura-Tam. That night, they had a light meal with Lt. General Kamanin and were asleep by 2130 hours when Korolev quietly visited to check up on the two. Physicians attached sensors to both cosmonauts to monitor their vital systems during the night. In addition, unbeknown to both, special strain gauges were attached to their mattresses to monitor whether the trainees had had a fitful night of tossing and turning.⁹⁹ As it turned out, both men slept remarkably peacefully.

Korolev did not sleep at all that night. Among the many worries on his mind, perhaps the most troubling was the prospect that the rocket's third stage would fail during the ascent to orbit, depositing the Vostok spacecraft in the ocean near Cape Horn on the southern tip of Africa, an area infamous for its constant storms. The chief designer had demanded that there be a telemetry system in the launch bunker at Tyura-Tam to confirm that the third stage had worked as planned. If the engine worked nominally, the telemetry would print out a series of "fives" on tape; otherwise, there would be a series of "twos." Despite all the precautions, all

97 Kamanin *Skrytiy kosmos* pp 48–49 Golovanov Koroleu p 638

98 Golovanov Koroleu p 640

99 *Ibid* p 641 The primary physicians in charge of Gagarin and Titov at the time were I. T. Akulinichev and A. R. Kotovskaya. The strain gauges were designed by engineers I. S. Shadrintsev and F. D. Gorbov.

the testing, and all the preparations, Korolev still had his doubts. One military officer recalled, "For some reason, it was just Cape Horn that would not give Korolev a moment's peace."¹⁰⁰

Prelaunch pad operations at site 1 began at 0300 hours on April 12, just before dawn, as controllers began taking their stations not only at Tyura-Tam, but all over the Soviet Union. A very brief readiness review meeting of the State Commission at 0600 hours ended with an "all prepared" conclusion, after which the members dispersed to various duties. Gagarin and Titov themselves had been woken up half an hour earlier by Cosmonaut Training Center Director Karpov and presented with a bunch of early wild flowers, a gift from the woman who had previously owned the cottage. After a short breakfast with food from a tube (meat paste, marmalade, and coffee), a group of doctors led by Yazdovskiy, almost ten years after he had led the first historic flight of dogs from the deserts at Kapustin Yar, examined the cosmonauts. Two assistants helped Gagarin and Titov don their bulky *Sokol* spacesuits—first a pale blue pressurized suit, followed by a bright orange coverall. Titov was the first to suit up to prevent Gagarin from overheating because the suits depended on external power sources for the cooling fans, which were only on the transport bus. Within an hour of waking up, both cosmonauts were on the bus, accompanied by eleven other individuals, including cosmonauts Nelyubov and Nikolayev and two cameramen who recorded the entire trip.¹⁰¹ The jaunt was short, and there was apparently much joking between Gagarin and the rest. Numerous photos of that short bus ride show a sometimes pensive Gagarin, seemingly unaffected at being at the center of this massive undertaking.

On arrival at the pad, Gagarin and Titov were greeted by Korolev, Keldysh, Karnanin, Moskalenko, State Commission Chairman Rudnev, and other officials. By all accounts, Korolev clearly looked fatigued and tired as he quietly watched Gagarin say his final goodbyes. As onlookers stood around, Gagarin turned to Rudnev and reported very briefly that he was ready for the mission. One of the more enduring myths of the flight was that before he took the elevator up to the top of the rocket, Gagarin made a farewell speech. Soviet-era journalists for years outdid each other by putting together and embellishing disjointed quotes from Gagarin with sugar-coated melodramatic flourishes, such as "I was seized by a total lifting of all my spiritual forces, with all of my being I heard the music of nature. . . ." To this day, documentaries often play a tape of Gagarin speaking to the assembled crowd at the base of the booster, but this speech was in fact taped much earlier, in Moscow, when Gagarin was essentially forced to utter a stream of banalities prepared by anonymous speechwriters. Similar speeches by Titov and Nelyubov were also taped." After last-minute embraces with Rudnev, Moskalenko, and Korolev, Gagarin was escorted to the service elevator, where he halted and waved excitedly one last time before the two-minute ride to the top. Titov was left behind, thus separating the futures of these two men—one into history and one into posterity.

Vostok lead designer Oleg C. Ivanovskiy helped Gagarin into the spacecraft, who switched on the radio communications system at 0710 hours. For the next two hours, he chatted effusively with Korolev and "capcom" cosmonaut Popovich. Kamanin, Chief Designer Bykov, and

¹⁰⁰ Mikhail Rebrov "A Star Traversing Cape Horn" (English title) *Krasnaya zvezda* April 12 1994 p 2

¹⁰¹ Colovanov *Korolev* pp 644–55 The individuals apart from Nelyubov and Nikolayev who were on the bus were TsPK Director Ye A Karpov Plant No 918 Chief Designer S M Alekseyev F A Vostokov V I Svershchek G S Petrushin Yu D Kilosanidze (all from Plant No 918) physician L G Golovkin and cameramen V A Suvorov and A M Filippov

¹⁰² *Ibid* p 649 The prepared speech included the following passage "Dear friends you who are close to me and you whom I do not know fellow Russians and people of all countries and all continents In a few minutes a powerful space vehicle will carry me into the distant realm of space What can I tell you in these last minutes before the launch? My whole life appears to me as one beautiful moment All that I previously lived through and did was lived through and done for the sake of this moment " See Evgeny Riabchikov *Russians in Space* (Garden City NY Doubleday & Company 1971) p 19

Commission Chairman Rudnev also took the mike on occasion to wish him well. The main command bunker, comprising several rooms, was walking distance from the actual launch pad. On the day of the launch, officials had set up a small table with a green tablecloth specifically for Korolev in the main room. Here there would be a two-way radio and a single red telephone for giving the password to catapult the cosmonaut in case of an emergency during the first forty seconds of the launch. Only three people knew the password: Korolev, his Deputy Leonid A. Voskresenskiy, and Colonel Anatoliy S. Kirillov, a Strategic Missile Forces officer who had recently been appointed to head the First Directorate at Tyura-Tam—that is, the division responsible for launch operations. His predecessor had been killed in the recent R-16 disaster. For Voskresenskiy, it was the culmination of a long career as Korolev's deputy for flight testing. His exploits in testing the German A-4s at Kapustin Yar in the 1940s were by then part of legend. Apart from Korolev, Voskresenskiy, and Kirillov, the three men primarily responsible for directing the launch, others in the main room included Mark L. Gally, the renowned Soviet test pilot who had assisted cosmonaut training. Korolev apparently allowed him to witness the launch, not for his piloting skills, but because Gally was an accomplished author—one who could chronicle the events for those who did not have the fortune to actually be present. Most of the members of the State Commission, as well as senior engineers such as Glushko and Feoktistov, were housed in a second room called the "guest room" of the bunker. In the third room, Chief Designer Ryazanskiy served as head of telemetry systems." Gagarin's call sign was *Kedr* ("Cedar"), while the ground call sign was *Zarya-1* ("Dawn-1"), most likely named as such because of the same designation of the primary voice communications system on Vostok.

At 0750 hours, the hatch was closed, but one of the contacts indicated that it was not pressed down properly. Three engineers at the top of the rocket removed all thirty screws in the hatch and shut the hatch a second time when all the indicators were positive. This action took almost an hour, and the technicians finally left the vicinity of the Vostok about thirty minutes prior to the scheduled launch. An excerpt from the communications from *Kedr* to *Zarya-1* shows that despite the risks involved, there were attempts to alleviate some of the tension:

0814 hours

Popovich: Yuriy, you're not getting bored there, are you?
Gagarin: If there was some music, I could stand it a little better.
Popovich: One minute.

0815 hours

Korolev: Station Zarya, this is Zarya 1. Fulfill *Kedr's* request. Give him some music, give him some music.
Popovich: Did you read that? Zarya answers: We'll try to fulfill your request. let's have some music or I'll get bored.



A pensive Yuriy Gagarin is in the bus on the way to the launch pad on the morning of April 12, 1961. Behind him, seated, is his backup, German Titov. Standing are cosmonauts Grigoriy Nelyubou and Andrian Nikolayev (files of Asif Siddiqi)

103 Others in the main room included OKB-1 engineer B. A. Dorofeyev, Air Force officer N. P. Kamanin, NII-885 Chief Designer N. A. Pilyugin, cosmonaut "capcom" P. R. Popovich, and NII-885 Deputy Chief Designer V. P. Finogenov. See rbtd pp. 647-48.

0817 hours

Popovich: *Well, how is it? Is there music?*
 Gagarin: *No music yet, but I hope there'll be some soon*
 Korolev: *Well, they gave you music, right?*
 Gagarin: *Not yet.*

0819 hours

Korolev: *Of course, that's the way musicians are: now they're here, now they're there, but they don't do anything very fast, as the saying goes. Yuriy Alekseyevich.*
 Gagarin: *They gave me love songs.¹⁰⁴*

At T (launch) minus fifteen minutes, Gagarin put on his gloves and ten minutes later closed his helmet. The tower was taken away from the pad at the same time. By this time, the tension was clearly rising, and Korolev and Voskresenskiy both took tranquilizer pills to calm their hearts. The record of the 8K72K booster was not something that instilled confidence. Up to that time, there had been sixteen launches of the R-7 with the Blok Yé third-stage combination, which was to send Gagarin to orbit. Of those sixteen launches, six had failed because of faults in the R-7, while two had failed because of the Blok Yé itself—that is, a success ratio of exactly 50 percent. In the case of the seven Vostok spacecraft flown, two spacecraft had failed to reach orbit because of booster malfunctions, while two others had failed to complete their missions." For an endeavor that theoretically required a 100-percent guarantee of success, if the past record was any indication, the potential for an accident was significant on Gagarin's mission.

While Korolev and Voskresenskiy may have needed to calm their selves down, Gagarin, removed in some way from the hubbub of activity at the pad, was as calm as ever:

0841 hours

Kamanin: *How do you read me?*
 Gagarin: *I read you well. How do you read me?*
 Kamanin: *Your pulse is 64, respiration 24. Everything is going normally.*
 Gagarin: *Roger. That means my heart is beating."¹⁰⁵*

Gagarin's pulse rate reached an excited 157 beats per minute seconds before liftoff, although his tone remained completely calm. Finally, at exactly 0906 hours, 59.7 seconds on April 12, 1961, the Vostok spacecraft lifted off with its twenty-seven-year-old passenger, Senior Lieutenant Yuriy Alekseyevich Gagarin. His first exuberant words were: "We're Off!"¹⁰⁶

Korolev, Voskresenskiy, and Kirillov had the abort codes in case the 8K72K booster did not achieve nominal performance, but the launch trajectory was on target. For the first few minutes after launch, Gagarin reported feeling the g-loads on him rise, but he gave no indication of any lack of comfort. In fact, he maintained his sense of humor:

104. Belyanov, *et al.*, "Yuriy Gagarin's Star Voyage." p. 110.

105. Riabchikov, *Russians in Space*, p. 21; Semenov, ed., *Raketno-Kosmicheskaya Korporatsiya*, p. 113

106. Belyanov, *et al.*, "Yuriy Gagarin's Star Voyage." p. 111

107. *Ibid*

0909 hours

Korolev: T plus 100. How do you feel?

Gagarin: I feel fine. How about you?¹⁰⁸

At T+119 seconds, the four strap-on boosters of the base R-7 missile separated, allowing the center sustainer to continue to fire. The payload shroud separated from the Vostok spaceship exactly fifty seconds later as planned. At about five g's, Gagarin reported some difficulty in talking, saying that all the muscles in his face were drawn and strained. The g-load steadily increased until the central core of the launcher ceased to operate and was detached at T+300 seconds." Following the separation of the spent core and strap-ons, the RD-0109 upper stage engine ignited to accelerate the craft to orbital velocity.

Korolev was literally shaking through all of this, having obsessed over the possible landing in the ocean south of Cape Horn if the upper stage failed. The incoming telemetry began to stream in a series of "fives," indicating all was fine. Then, suddenly, the numbers changed to a series of "threes." There were brief seconds of terror—a "two" was a malfunction, but what was a "three"? After a few agonizing seconds, the numbers reverted back to "fives." Engineer Feoktistov remembers that "these interruptions, a few seconds in length, shortened the lives of the designers."

During the powered leg of the flight, Gagarin's pulse reached a maximum of 150 beats per minute. Although Popovich was officially the "capcom" for the mission, Korolev's excitement most likely got the better of him, and he took over communications personally for a good portion of the ascent to orbit, constantly asking Gagarin about his well being:

0910 hours

Korolev: The fairing has been jettisoned, everything is normal. How do you feel?

Gagarin: . . . Nose fairing jettisoned. . . I see the Earth. The g-load is increasing somewhat. I feel excellent, in a good mood.

Korolev: Good boy! Excellent! Everything is going well.

Gagarin: I see the clouds. The landing site. . . It's beautiful. What beauty! How do you read me?

Korolev: We read you well. continue the flight.¹¹¹

Orbital insertion occurred finally at T+676 seconds just after shutdown of the third-stage RD-0109 engine. For the first time in history, a human being had escaped the bonds of Earth's gravity and entered outer space. Initial orbital parameters for the Vostok spaceship were 175 by 302 kilometers at a 65.07-degree inclination to the equator. The orbit was much higher than had been planned for the flight; the apogee was about seventy kilometers over the planned altitude, indicating a less than stellar performance for the launch booster. When the parameters were reported back to Tyura-Tam from the flight control center at NII-4 in Moscow, no doubt there was some anxiety because the higher orbit could have resulted in a longer mission given retrofire failure.

Immediately after entering orbit, Gagarin reported that he was feeling excellent and vividly described the images outside his porthole. In his secret postflight report, he recalled his feelings of being the first human being to experience prolonged microgravity:

108. *Ibid.*, p. 112.

109. Gibbons and Clark, "The Evolution of the Vostok and Voskhod Programmes "

110. Rebrov, "A Star Traversing Cape Horn."

111. Belyanov, et al., "Yuriy Gagarin's Star Voyage." p. 112

I ate and drank normally, I could eat and drink. I noticed no physiological difficulties. The feeling of weightlessness was somewhat unfamiliar compared with Earth conditions. Here, you feel as if you were hanging in a horizontal position in straps. You feel as if you are suspended. Obviously, the tightly fitted suspension system presses upon the thorax. . . . Later I got used to it and had no unpleasant sensations. I made entries into the logbook, reported, worked with the telegraph key. When I had meals, I also had water. I let the writing pad out of my hands and it floated together with the pencil in front of me. Then, when I had to write the next report, I took the pad, but the pencil wasn't where it had been. It had flown off somewhere. The eye was secured to the pencil with a screw, but obviously they should have used glue or secured the pencil more tightly. The screw got loose and flew away. I closed up my journal and put it in my pocket. It wouldn't be any good anyway, because I had nothing to write with.'

Once the orbital parameters had been accurately determined, controllers at NII-4 sent the numbers to news agencies in Moscow, instructing reporters to open their secret envelopes. Because of simple gross inefficiency, the Soviet news agency TASS was unable to announce the launch until almost an hour after Gagarin took off. Everyone back at Tyura-Tam was bewildered, unsure as to why the news was not on the radio despite assurances that it would be so. Finally, a full fifty-five minutes after launch, famous Soviet radio personality Yuriy B. Levitan announced:

The world's first satellite-ship "Vostok" with a human on board was launched into an orbit about the Earth from the Soviet Union. The pilot-cosmonaut of the spaceship satellite "Vostok" is a citizen of the Union of Soviet Socialist Republics. Major of Aviation Yuriy Alekseyevich Gagarin.¹¹³

U.S. intelligence services were already cognizant of the mission prior to the announcement. An electronic intelligence station in Alaska had picked up transmissions from the spacecraft, just twenty minutes after launch. Further real-time interceptions of communication thirty-eight minutes later clearly showed a human moving inside the spacecraft.¹¹⁴

Most of Gagarin's single orbit was spent observing the view through the porthole and the systems in the craft itself. No experiments were planned for the mission, and no anomalies were detected during his time in orbit. Because of physicians' concerns about the adverse effects of weightlessness on the psychology of the cosmonaut, precautions were taken to ensure that the cosmonaut could not control the spacecraft and endanger his life. A special six-digit code was programmed on a special "logic clock" to lock the controls on the ship; Gagarin was not told three of the missing digits. If the Vostok was to lose its ground command link, then Gagarin could unseal a special envelope that contained the code (1-2-5) and thus unlock the controls. Otherwise, all the flight actions took place automatically or were controlled by the ground.

When contact with Zarya-1 at Tyura-Tam was lost about seven minutes after launch, Gagarin maintained contact with Zarya-2 at Kolpashevo and Zarya-3 at Yelizovo.¹¹⁵ Prior to

¹¹² *Ibid* p 119

¹¹³ 'Tass Communiqué on the World's First Flight of a Human into Cosmic Space' (English title) *Pravda* April 13 1961. This report has also been published in Raushenbakh, ed., *Materialy po istorii kosmicheskogo* p 146

¹¹⁴ Dwayne Day "Those Magnificent Spooks and their Spying Machines" *Spaceflight* 39 (March 1997) 98-100

¹¹⁵ The communicators at Zarya 2 were Air Force Lt Colonel G. I. Titarev and military unit no. 32103 representative Lieutenant B. V. Seleznev. The communicator at Zarya 3 was Air Force Colonel M. F. Karpenko. In addition, communications were also maintained with the station at Khabarovsk (Air Force Colonel M. P. Kaduskin) and in Moscow (Desna) at NII 4 (Captain V. I. Khoroshilov)

retrofire, the Vostok ship was oriented to the correct attitude using the solar sensor system, resulting in three commands to fire the small thrusters. The TDU-1 retrorocket system successfully fired at 1025 hours, and Gagarin noted the status of all the systems, recording his comments on a tape recorder because he was out of range of ground communications:

The braking rocket fired for exactly 40 seconds. During that period, the following occurred. As soon as the braking rocket shut off, there was a sharp jolt, and the craft began to rotate around its axis at a very high velocity. The Earth passed in the "Vzor" from top right to bottom left. The rate of rotation was about 30 degrees per second, at least. I was an entire "corps de ballet": head, then feet, head, then feet, rotating rapidly. Everything was spinning around. Now I see Africa (this happened over Africa), next the horizon, then the sky. I had barely enough time to cover myself to protect my eyes from the Sun's rays. I put my legs to the porthole, but didn't close the blinds."

Following the firing of the retrorocket engine, the large instrument section of the vehicle was to separate from the spherical descent apparatus, with the latter descending into the upper layers of the atmosphere. It was precisely at this point that the only major malfunction occurred on the mission:

I wondered what was going on and waited for the separation. There was no separation. I knew it was scheduled in 10 to 12 seconds after actuation of the retrorocket. When it was actuated, all the lights of the control board went out. I felt that more time had passed, but there was no separation. The light panel "landing-1" failed to go out.¹⁷

The separation mechanism, comprising four metal strips that came together in a single lock, evidently released the two modules on time, but the compartments remained loosely connected by a few cables; the heavier descent apparatus remained below the lighter instrument section as the combined spacecraft reentered the atmosphere. Although the situation was of serious concern, it does not now seem that Gagarin's life was in jeopardy, as suggested by some Western analysts when this incident was finally revealed in 1991. Gagarin, who was clearly cognizant of the situation, remained remarkably calm:

. . . still no signs of separation. The "corps de ballet" continues. I thought that something had gone wrong. I checked the time on the watch. About two minutes had passed but there was no separation. I reported through the [high-frequency] communications channel that the [retrorocket] had worked normally. I estimated that I would be able to land normally anyway, because the distance to the Soviet Union was six thousand kilometers and the Soviet Union was about eight thousand kilometers long. That meant that I could land before the Soviet far east. So I decided not to make much ado about that. I used the telegraph key to transmit the "VN" message meaning "all goes well."¹⁸

Separation finally occurred at 1035 hours, approximately ten minutes later than intended, saving the spacecraft from a dangerous tumbling reentry. Gagarin's description of a ballistic reentry, the first such in history, was vivid and full of illuminating details:

116. Belyanov, et al., "Yuriy Gagarin's Star Voyage." p. 120.

117. *Ibid*

118. *Ibid*, pp 120-21.

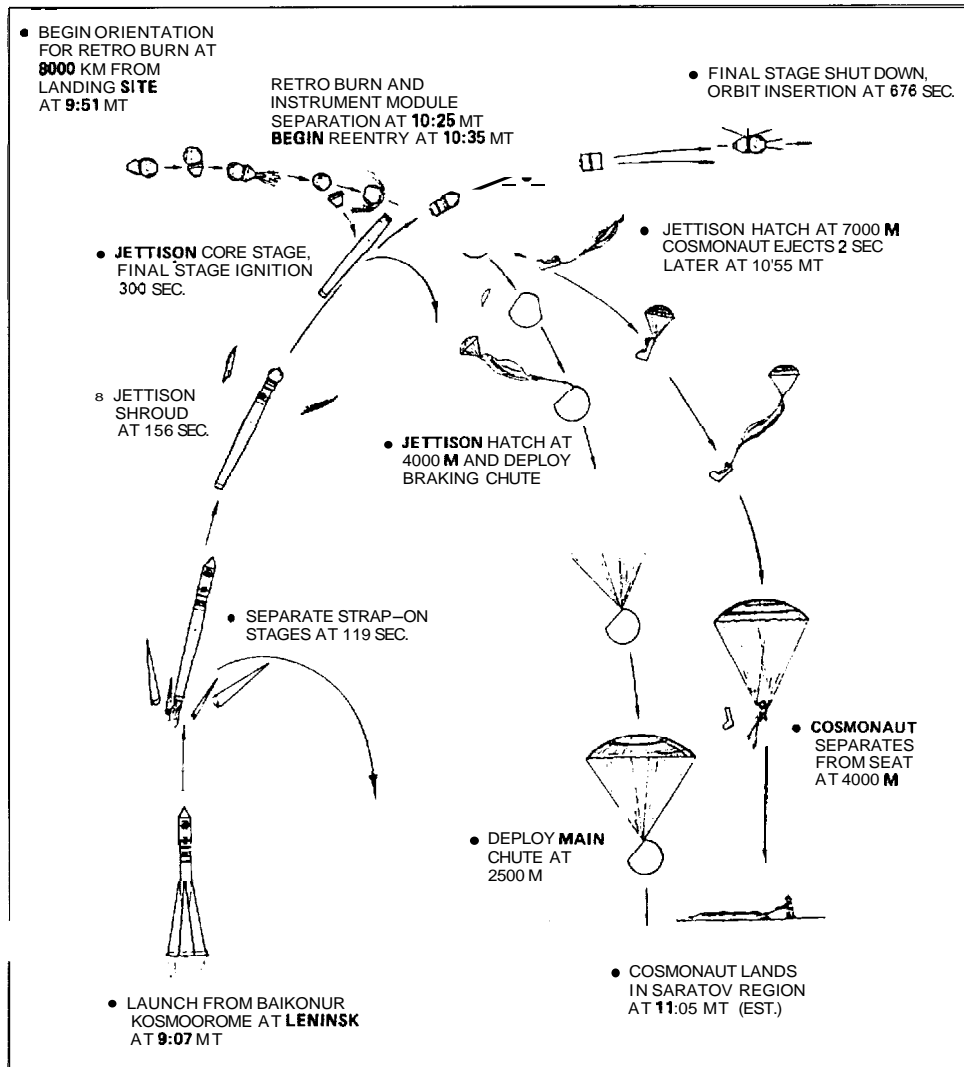

This is the mission profile for Yuriy Gagarin's pioneering flight into space. (copyright R F Gibbons)

Suddenly a bright purple light appeared at the blind edges. The same purple light could be observed in the small opening of the right-hand porthole. I felt oscillations of the spaceship and burning of the coating. I don't know what caused the crackling sounds: whether it was the structure or because of the heat-resistant casing expanding as a result of the heat, but I heard crackling sounds. The frequency was approximately one crackling per minute. Generally, I felt the temperature was high. . . . Next the overloads began to rise gradually. The ball was constantly oscillating along all axes. As the load factor was reaching its peak. I could see the Sun. Its rays penetrated into the cabin through the porthole of hatch 1 and the right-hand porthole. By the reflected rays of the Sun I could tentatively determine how the spaceship was rotating. By the time the load factor reached its peak, the spaceship oscillations reduced to 15 degrees. At that moment I felt that the load factor reached about 10g. There was a moment for about

CHALLENGE TO APOLLO

2 or 3 seconds when the instrument readings became blurred. My vision became somewhat greyish. I strained myself again. This worked, and everything assumed their proper places.¹¹⁹

At an altitude of 7,000 meters, the main descent apparatus parachutes opened, and then hatch number one shot off from the capsule. Gagarin was shot out of the craft, still in his seat, just two seconds later. Looking down at the land, he immediately recognized that the region of landing was near the Volga River. He separated from his seat, and his personal parachute then opened. He recalled later:

When I was parachute training, we had jumped many times over this very site. We had flown much here. I recognized the railroad, a railroad bridge over the river, and a long spit of land extending far into the Volga. I thought that was probably Saratov. I was landing in Saratov.¹²⁰

Ground control spent several minutes in tension following reentry, when communications were cut off. Soon after the command for retrofire occurred, Korolev telephoned Khrushchev, who was at the holiday resort at Pitsunda, telling him that "the parachute has opened, and he's landing. The spacecraft seems to be OK!" Khrushchev asked excitedly, "Is he alive? Is he sending signals? Is he alive? Is he alive? . . ."

Gagarin, very much alive, landed relatively softly in a field next to a deep ravine at 1055 hours, just one hour and forty-eight minutes following launch. The landing point was twenty-six kilometers southwest of the town of Engels in the Saratov region, close to the village of Smelovka. Immediately after landing, he had some trouble opening up the air valve in his spacesuit, and it took him six whole minutes of wrestling before he was able to breathe natural air. His first concern was reporting that he was safe:

I had to do something to send a message that I had landed normally. I climbed a small hill and saw a woman with a girl approaching me. She was about 800 meters away from me. I walked to her to ask where I could find a telephone. So I was walking to her, when I saw that the woman was slowing down and the girl was going away from her and running back. When I saw that, I began to wave my hands and shout: "I'm a friend. I'm Soviet!" She told me that I could use the telephone in the field camp. I asked the woman not to let anyone touch my parachute while I was going to the camp. As we approached the parachutes, we saw a group of men, about six all in all — tractor drivers and mechanics from the field camp. I got acquainted with them. I told them who I was. They said that news of the space flight was being transmitted at that moment over the radio.¹²²

Eventually, rescue teams arrived and drove him to a military unit not far from Engels, where he received a telegram of congratulations from Khrushchev and reported officially by telephone to Air Force Commander-in-Chief Vershinin on having completed his assigned mission. Vershinin's deputy, Col. General Agaltsov, was the first high-ranking space official to meet the cosmonaut, and after further cursory congratulatory phone calls from Khrushchev and Brezhnev. Gagarin was quickly escorted out to seclusion at Kuybyshev in the Zhiguli Hills on the Volga.

119 *Ibrd* p 121

120 *Ibrd* p 122

121 M Rebrov "The Difficult Path to April 1961 or Why We're Not Finding Out the Entire Truth About the Flight of Yu Gagarin Until Today" (English title) *Krasnaya zvezda* March 28 1992 p 3

122 Belyanov et al "Yuriy Gagarin's Star Voyage" p 122

Back at Tyura-Tam, once news arrived that Gagarin was safe, the tensions that had pervaded the entire mission instantly dissipated. After a short meeting of the State Commission, champagne was passed around amid much mutual congratulations. Korolev was completely beside himself, laughing and smiling for the first time in days, excited and animated beyond what many of his colleagues had ever seen from him. The members of the commission flew to the landing site to inspect the descent apparatus; witnesses remember that Korolev could simply not take his eyes off the capsule, touching it and checking it all over. After the inspection, they flew off to Kuybyshev to finally meet with Gagarin, who had just minutes before been promoted from a senior lieutenant directly to major. Upon seeing the Korolev, Gagarin reported quietly. "All's well, Sergey Pavlovich, things are just fine." According to one journalist, Korolev was so beside himself with the shock of euphoria that he was speechless: "[He] had no clue what to say or how to reply [to Gagarin]."¹²³

During the next morning, there was an official and final meeting of the *ad hoc* State Commission, during which Gagarin described his entire flight in great detail, a narrative that was preserved on tape. Following the monologue, commission members asked him a series of questions on various aspects of the flight. On April 19, Marshal Vershinin formally presented the transcripts of both sessions to the Central Committee. Both were classified "Top Secret" and unavailable to researchers until 1991, thirty years after the mission.¹²⁴

Earlier on April 14, Gagarin returned to Vnukovo Airport in Moscow while thousands of onlookers cheered him on. A procession of scores of automobiles finally led the way to Red Square, where Khrushchev, Brezhnev, Kozlov, and other leaders of the Soviet state basked in the unqualified success of the first mission into space by a human. It was a moment unlike any other in Soviet history, quite possibly the absolute zenith of the more than forty years of Soviet achievements in space. Derided for years by the West for its backwards technology and antiquated customs, the Soviet Union had abruptly taken one of the most important steps in the history of humankind, the first voyage of a human into space. It was a day full of hyperbole from thousands of people on the streets, but anything less would not have done justice to it. Korolev, the chief architect of this achievement remained, as ever, anonymous among the multitudes. He traveled several cars behind the leading motorcade in a nondescript vehicle, prevented from wearing his previous state awards on his lapel for fear that Western agents would suspect something. Such was the curious and perhaps sad legacy of a powerful and great nation, unencumbered by notions of political freedom.

The flight of Yuriy A. Gagarin will undoubtedly remain one of the major milestones in not only the history of space exploration, but also the history of the human race itself. The fact that this accomplishment was successfully carried out by the Soviet Union, a country completely devastated by war just sixteen years prior, makes the achievement even more impressive. Unlike the United States, the USSR had to begin from a position of tremendous disadvantage. Its industrial infrastructure had been ruined, and its technological capabilities were outdated at best. A good portion of its land had been devastated by war, and it had lost about 25 million citizens. Thus, comparisons of the uncannily close race between the two superpowers in the early years after Sputnik are in some ways flawed by the absence of context. In the crudest of terms, it was a devastated totalitarian society with old-fashioned machines competing against an intact and democratic one equipped with far better technology. Both exercised the political imperative to explore space, but it was the totalitarian state that overwhelmingly took the lead.

123 Colovanov, Korolev, pp. 654-56

124 Both have been reproduced in full in Belyanov. *et al.*. "Yuriy Gagarin's Star Voyage." pp. 117-28

The Secret World

In attempting to maintain a tight shroud of secrecy around the Vostok mission and the space program as a whole, Soviet officials went to great and sometimes ludicrous levels of effort. Having told the full story of his flight to the State Commission, Gagarin was later forced to partake in a gross obfuscation of the truth. To satisfy international standards for an aerospace record for a piloted orbital flight, the passenger was required to take off and land in the same vehicle. Gagarin, of course, parachuted out of his descent apparatus prior to touchdown. Soviet authorities went to great lengths to conceal this fact, in many cases forcing Gagarin to blatantly lie during various press conferences. The first conclusive admission came ten years later in 1971, by which time Gagarin's flight was widely accepted as an international record.¹²⁵ The press conferences themselves were exercises in control and secrecy. A transcript from Gagarin's first postflight press conference illustrates the sometimes comic aspects of Gagarin's unenviable job:



The first human in space. Yuri Gagarin, seems very happy in this photo from 1961, taken soon after his historic mission (NASA photo)

- question:* When were you told that you were the first candidate?
Gagarin: I was told in good time that I was the first cosmonaut.
- question:* You said yesterday that your fellow pilot-cosmonauts are prepared for another cosmic flight. How many are there? Are there more than a dozen?
Gagarin: In accordance with the plan to conquer cosmic space, pilot-cosmonauts are being trained in the country. I believe that there are more than enough to undertake important flights. . . .
- question:* When will the next spaceflight take place?
Gagarin: I think that our scientists and cosmonauts will undertake the next flight when it is necessary.¹²⁶

As was typical during the aftermath of the first Sputnik launch, a number of important academicians were used for elucidating some of the technical aspects of the mission, thus implying that they were in some way connected to the facilitation of the mission. The most prominent of these was Academician Anatoliy A. Blagonravov, whose official title was Academic Secretary of the Department of Technical Sciences of the USSR Academy of Sciences. The sixty-six-year-old machine sciences expert had some tenuous ties to the space

¹²⁵ To the knowledge of this author, the first reliable confirmation that Gagarin indeed landed in his capsule was in Riabchikov *Russians in Space* p. 36

¹²⁶ Peter Smolders *Soviets in Space* (New York: Taplinger Publishing Co., 1973), p. 115

establishment, but his high-visibility trips to various congresses cemented the myth that he was in some manner one of the leaders of the entire effort.

Forced to formally report a launch location for the Vostok spacecraft, the Soviets also created the fiction of a great new spaceport named "Baykonur." A few days following Gagarin's mission, a team led by Maj. General Kerimov, the head of the Third Directorate in the Chief Directorate of Reactive Armaments of the Missile Forces, prepared a document to submit to the International Astronautical Federation on the details of the mission. Prohibited from mentioning Tyura-Tam, Kerimov and his assistants picked the small settlement of Baykonur, 370 kilometers northeast of the actual launch site.¹²⁷ Although Western observers were quickly able to identify the real location with the aid of tracking data, the Soviets continued to insist on the Baykonur name for the launch area for close to thirty years. At first amused by the sudden fame of their native town, the inhabitants of the actual city of Baykonur tried to use the confusion over names to their own advantage. They put in orders for all sorts of scarce raw materials, such as cement and wood, to officials in Moscow, all of which they received in vast quantities. Moscow officials later stopped all such disbursements once they realized that they were the victims of a shrewd scam.¹²⁸ In a twist of which George Orwell would have been proud, the "Baykonur Cosmodrome" designation eventually came into accepted usage even among workers at Tyura-Tam. In 1996, the town of Leninsk was officially renamed Baykonur, the center of the Baykonur Cosmodrome.

Gagarin's flight had a large-scale repercussive effect on the growing space industry. Awards and promotions were liberally handed out to numerous important individuals, while space as a component of the ballistic missile program began to acquire an independent character. By an order dated June 17, 1961, 6,938 men and women were honored with various awards, including a number with the Hero of Socialist Labor, the highest and most prestigious national civilian honor in the Soviet Union. Characteristically, the Soviet press only named seven of the almost 7,000, all of them high officials in the Communist Party and government. The seven who were named for the Hero of Socialist Labor were Khrushchev (for the third time), Kozlov, Brezhnev, Ustinov (for the second time), Rudnev, Kalmykov, and Academician Keldysh (for the second time). Among those who remained unnamed, five of them were chief designers receiving the award for the second time: Korolev, Glushko, Barmin, Pilyugin, Kuznetsov, and Yangel were invited to the Kremlin at a secret ceremony on June 20.¹²⁹

Concurrent with the bestowal of these honors, a major reshuffle in the Soviet space industry took place. At the apex of these changes was the replacement of the chairman of the State Committee for Defense Technology, the "ministry" with control over the space program. The Soviet press announced on June 10, 1961, that Committee Chairman Konstantin N. Rudnev

¹²⁷ Mozzhorin *et al.* eds. *Nachalo kosmicheskoy ery* pp. 320-21. The others involved with Kerimov in making the decision were Colonel A. A. Maksimov (CURVO) and Major V. D. Yastrebov (NII 4). See also Jacques Villain, ed. *Baikonuor la porte des étoiles* (Paris: Armand Colin, 1994), p. 47.

¹²⁸ Golovanov, *Korolev*, p. 642.

¹²⁹ Of the ninety-five people who received their Hero of Socialist Labor awards for the first time were the following chief designers or institute directors: S. M. Alekseyev (Plant No. 918), Yu. S. Bykov (NII 695), L. I. Cusev (NII 695), G. Ya. Guskov (NII MikroPribor), A. C. Iosifyan (NII 627), S. A. Kosberg (OKB 154), N. A. Krivoshein (TsKB TyazhMash), V. P. Makeyev (SKB 385), I. A. Rosselevich (VNII 380), N. A. Semikhatov (NII Avtomatiki), V. G. Sergeev (OKB 692), V. S. Shpak (GIPKh), G. M. Tabakov (NII 229), and G. I. Voronin (OKB 124). Among the major omissions from the list were Chief Designers M. S. Ryazanskiy (NII 885) and A. M. Isayev (OKB 2). Both had, however, received the Hero of Socialist Labor in 1956, although Ryazanskiy was the only member of the original Council of Chief Designers who had not been bestowed the honor a second time in 1961. See Christian Lardier, "Soviet Space Designers When They Were Secrets," presented at the 47th International Astronautical Federation, IAA 96-IAA 2.2.09, Beijing, China, October 7-11, 1996. Albert Parry, *The New Class Divided: Science and Technology Versus Communism* (New York: Macmillan, 1966), p. 110; Golovanov, *Korolev*, p. 660.

had been released from his post and would chair the State Committee for the Coordination of Scientific Research, the "ministry" overseeing pure science in the Soviet Union. Rudnev, having played a leading role in facilitating the Vostok program, was in effect moved directly out of the so-called defense industry structure, thus relinquishing any further direct role in the space program. In an ironic twist, *The New York Times* reported his new appointment, suggesting that Rudnev had been appointed "coordinator of the Soviet Union's rocket and space programs" when it was exactly the reverse.¹³⁰ Rudnev's vacating of the defense technology post caused a row of individuals to move up, positing them as key players in the space program during the 1960s. Rudnev's own replacement was an unlikely choice, a forty-five-year-old former electrical engineer named Leonid V. Smirnov, who was without doubt the fastest rising star within the Soviet defense industry. He had served for almost ten years as the director of the mammoth State Union Plant No. 586, where the USSR manufactured most of its ballistic missiles. In mid-1959, during a visit to the plant site at Dnepropetrovsk in the Ukraine, Khrushchev had been unusually impressed with Smirnov's work.¹³¹ While this visit no doubt played a pivotal role in his rapid promotion in the following years, Smirnov also owed his every promotion to the powerful Ustinov, who had begun to populate various defense industry positions with his proteges, building a support system that played to his advantage for many years.

Smirnov himself vacated the post of First Deputy Chairman of the State Committee for Defense Technology, thus allowing the promotion of Maj. General Georgiy A. Tyulin to fill that position.¹³² Tyulin had served as the director of the important NII-88 from August 1959 until his new appointment. One of the most ubiquitous persons in the history of the Soviet space program, the artillery officer was reportedly a close supporter of Korolev's. The appointment of an artillery officer to such a high position in the defense industry was clearly a strong indication of the artillery lobby's ambitions to dominate the space program. Tyulin's appointment was, in fact, the first of many in which high-ranking artillery officers were moved from the Ministry of Defense directly to high managerial positions within the defense industry—that is, from the client sector to the design sector. This not only cemented their influence on both sides, but it prevented other armed services such as the Air Force from making inroads to control the space program.

The second artillery officer to move from the client side to the design side was Colonel Yuriy A. Mozzhorin, the individual who had directed the development of the Soviet ground-tracking network in support of ICBMs and satellites. On the recommendation of both Korolev and Tyulin, Mozzhorin took over the latter's vacated post as director of NII-88 on July 31, 1961.¹³³ During the years that Korolev's OKB-1 had been subordinated to NII-88 in the 1940s and 1950s, the institute had served as the *de facto* center of long-range ballistic missile developments in the Soviet Union. This responsibility had been somewhat diluted after 1956, when OKB-1 became an independent institution, because the locus of activity had moved from NII-88 to OKB-1. As a research institute instead of a design bureau, however, NII-88 continued basic research into many new technologies that were eventually used on space vehicles and

130 Rudnev Heads Soviet Space Drive *The New York Times* June 11 1961

131 V Pappo-Korystin V Platonov and V Pashchenko Dneprouskiy raketnokosmnrcheskyy tsentr (Dnepropetrovsk PO YuMZ/KBYu 1994) p 67 John McDonnell 'The Soviet Defense Industry as a Pressure Group' in Michael McGwire Ken Booth and John McDonnell eds *Soviet Naval Policy Objectives and Constraints* (Halifax NS Centre for Foreign Policy Studies 1975) p 120 Sergey Khrushchev *Nikita Khrushchev krizisy i rakety vzglyad iznutri tom I* (Moscow Novosti 1994) p 433

132 I V Kostryukov 'The Development in TsNII Mash of Branch Experimental Bases for the Development of Rocket Carriers and Space Apparatus' (English title) *Iz istorii aviatsii i kosmonautiki* 60 (1990) 41–55

133 On the Scientific-Technical Activities of Yu A Mozzhorin Yu A Mozzhorin 'The Central Scientific Research Institute of Machine Building—The Main Center for Soviet Rocket Space Industry' (English title) *Iz istorii aviatsii i kosmonautiki* 60 (1990) 20–40 Letter A A Yeremenko Chief of the Public Affairs Department of TsNII Mash to the author April 14 1994

boosters. By the late 1950s, under Tyulin's command, the entity gradually established a mandate for focus on applied themes rather than pure science. At the time of Mozzhorin's appointment to the directorship post in 1961, NII-88's agenda took a dramatic turn. No longer consigned exclusively to research and development efforts, the institute assumed a pivotal role in the formulation of Soviet space policy. An official decision of the government in 1961 designated NII-88 as the "primary science institution" in the Soviet space program.¹³⁴ The scope of responsibilities of NII-88 were summarized by a Soviet space historian using rhetorical questions:

*What rocket-space hardware is needed?
Which areas need to be developed first?
Which of the systems proposed by the
chief designers need to be developed and
which need to be refused? . . . All that
[was] worked out . . . under the supervi-
sion of Yu. A. Mozzhonn*¹³⁵

Thus, although the space chief designers were not officially subordinate to Mozzhorin, by the force of his new responsibilities, he would have the duty of recommending or rejecting proposals and then submitting them to the ministerial level.

The mind-boggling confusion of hierarchy that was the Soviet space program in the 1960s was tempered only by the institutional loopholes that allowed design bureaus and chief designers to push their programs through informal channels. The research and development process in the Soviet space industry and in the defense industry as a whole originated in four possible ways, by:

- Having the military identify a need for a capability and forward a request called a "tactical-technical requirement" to the ministry in question, in this case the State Committee for Defense Technology
- Having the chief designer of a particular design bureau propose a project in the form of a ten- to twenty-page "predraft plan"
- A combination of the first two—that is, having the chief designer cooperate with the military to develop a tactical-technical requirement simultaneously with a predraft plan
- A political imperative—that is, a directive from the Communist Party¹³⁶



Yuriy Mozzhorin was the director of NII-88 from 1961 to 1990. During that period NII-88 served as the "primary scientific institution" in the Soviet space program. Mozzhorin was personally responsible for rejecting or recommending to the government dozens of proposals from various chief designers (files of Peter Gorin)

¹³⁴ M. V. Tarasenko, *Voennyye aspekty Sovetskoi kosmonavтики* (Moscow: Nikol, 1992), p. 17.

¹³⁵ A. A. Maksimov, "People of Science: A Veteran of the Space Program" (English title), *Zemlya i uselanaya* no. 6 (November–December 1990), 30–31.

¹³⁶ William P. Bary, "The Missile Design Bureaus and Soviet Piloted Space Policy, 1953–1974," draft of University of Oxford Ph.D. diss., 1995.

In the case of the space program, it is now becoming clear that the second mode of operation was the most prevalent—that is, the most powerful chief designers, principally Korolev, Chelomey, Glushko, and Yangel, essentially drove space policy with a plethora of proposals in the form of predraft plans. At this point, a number of similar bodies, called scientific-technical councils, would come into play to review the plans and recommend a particular approach.

The number of scientific-technical councils was another indication of the way in which checks and balances were instituted in the space program. There was usually such a council in each design bureau to review proposals, there was one in NII-88, and there was one in the State Committee for Defense Technology. Within the military itself, there were at least three councils with relevance to the space program—one in the Ministry of Defense General Staff headed at the time by artillery Col. General Nikolay N. Alekseyev, one in the Strategic Missile Forces headed during the 1960s by Maj. General Viktor P. Morozov, and one in NII-4, which was responsible for devising the tactical-technical requirements. Finally, as the space program began to emerge as an independent entity from the ballistic missile effort, the government created a unique body called the Interdepartmental Scientific-Technical Council for Space Research within the USSR Academy of Sciences in 1958. Headed by Academician Keldysh, who had assumed the position of academy president on May 19, 1961, soon after Gagarin's flight, the council included representatives from the major space design bureaus and institutes, NII-4, the Strategic Missile Forces, and the Soviet Air Force. In the case of actual spacecraft proposals, it was this council rather than the others that had the final say, usually after a review period by the other bodies. The presence of military officers on the academy's council ensured a strong military component in each "civilian" proposal.

The result of the council review process was only a recommendation, albeit one that had the support of major players. The recommendation was then passed on to the ministry level, and eventually to the powerful Military-Industrial Commission headed by the all-watching Ustinov. Party support, indispensable for any program, was usually ensured by the appropriate chief designer prior to this point, usually with a meeting with Khrushchev or Kozlov. Given the sanction of Khrushchev or Kozlov, the project was formally approved by a joint decree of the USSR Council of Ministers and the Central Committee of the Communist Party. The program then would be managed under Ustinov, who was something of a genius in working through the paper-logged Soviet system. A "draft plan" for the project—that is, a detailed technical document describing the vehicle and its characteristics—was prepared during the process, often before official approval, perhaps to elicit interest from the military. In many cases, the scientific-technical councils were used to screen draft plans from competing proposals before being passed on to the top. The draft plan served as the final document from which the design bureau, in cooperation with its plant, produced the first experimental models of the spacecraft or launch vehicle.

The entire process of Soviet space policy was, of course, not derived from a formal hierarchical process. Unlike other defense industries, the space program was driven to grow by the powers of the leading chief designers. Thus, the approval or rejection of a project was often a function of the relationship that the chief designer had with key members of the Communist Party and government, in particular Khrushchev, Kozlov, and Ustinov. Even at that level, it was a complex process influenced by the fortunes of certain individuals. For example, Khrushchev strongly supported both Chelomey and Korolev, while Ustinov was a "patron" of both Korolev and Glushko and hated Chelomey; Kozlov meanwhile had a marked aversion to Korolev. The story of the

137 *Ibid.*, Mozzhorin, et al., eds., *Dorogi v kosmos II*, pp. 101, 103, Sergeev, ed., *Khronika osnovnykh sobytiye*, pp. 85–86; V. S. Avduyevskiy and M. Ya. Marov, "Mstislav Vsevolodovich Keldysh and Space Research" (English title). *Zemlya i vseennaya* no. 3 (May–June 1991): 46–52

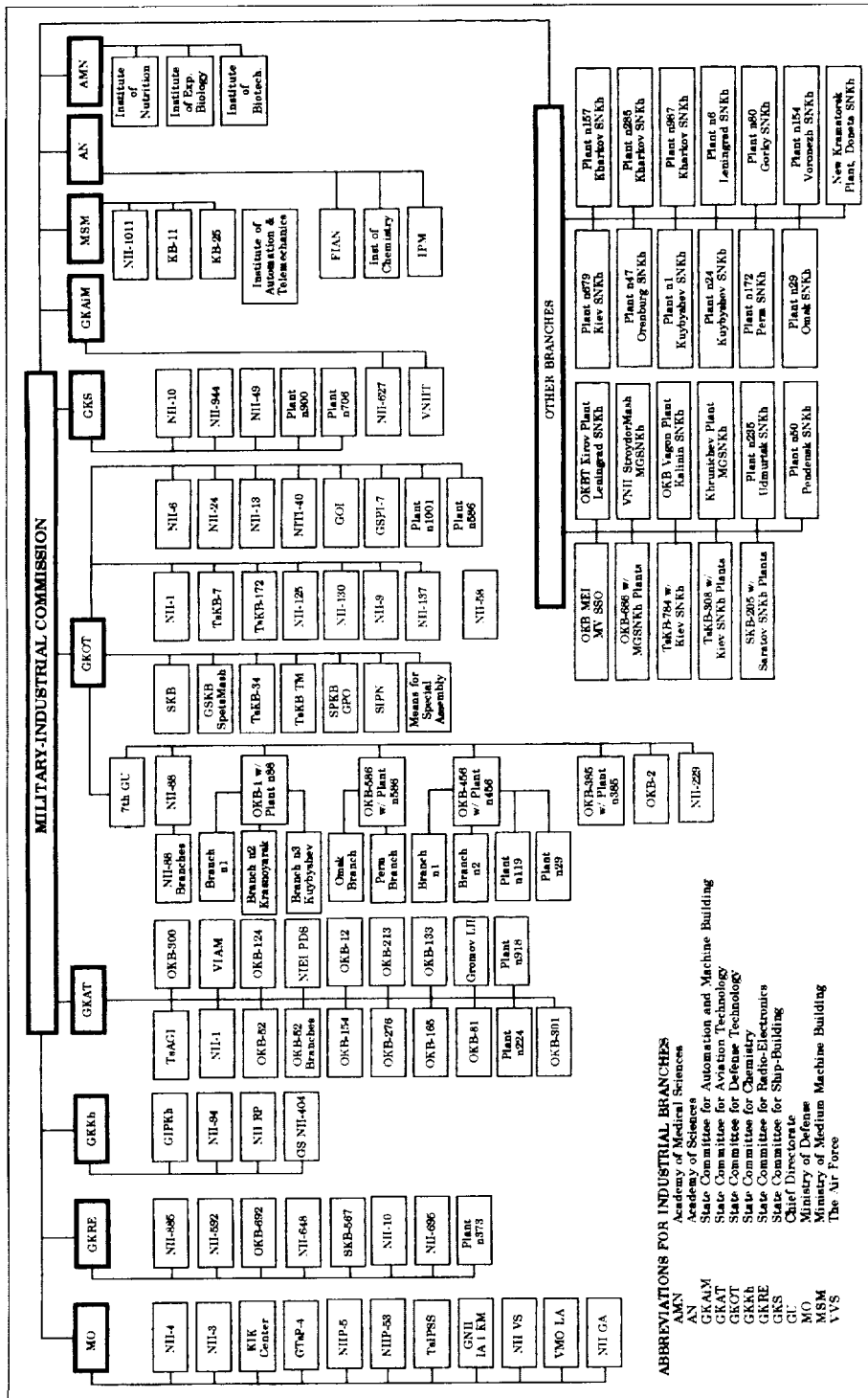

CHALLENGE TO APOLLO

The organization of the Soviet ballistic missile and space industry in 1961. (copyright Asif Siddiqi)

Soviet space program was thus in many ways a story of interpersonal rivalries and political expediency. Clogged by a rigorous process of review and unending red tape, there were many worthy proposals that simply fell by the wayside as the fortunes of chief designers rose and fell.

The important chief designers were clearly Korolev, Glushko, Yangel, and Chelomey, but it would be an oversimplification to suggest that others had no say. For example, the other members of the original Council of Chief Designers, while not performing in the capacity of "primary contractors" for space vehicles, could often derail or provide critical support to a project. In 1961, the Soviet government passed a decree defining the rights and status of the Council of Chief Designers, ensuring that the decisions of the body were binding to all the concerned ministries and agencies.¹³⁸ These decisions were most likely related to operational actions, such as to force a subcontractor to deliver on time or to approve a particular launch, rather than actual policy. On purely technical issues, the council operated in a fairly democratic manner in the early years. For example, if a problem occurred in a given engineering area, a meeting of the council would be held at the particular design bureau that had specialty over the problem in question. Although Korolev presided over the meetings, the chief designer whose expertise covered the matter most appropriately resolved each disagreement in technical matters. Chief Designer Barmin has recalled, however, that "we never, I should emphasize, never turned the council into a trade-union meeting of sorts, in which decision was made by a mechanical majority of votes."¹³⁹ Thus, the veto of Pilyugin or Barmin on a particular issue could bring a matter to a standstill regardless of whether Korolev or Glushko believed otherwise.



This photo of the Council of Chief Designers dates from 1959 during control of a Luna mission to the Moon. From the left are Aleksey Bogornolov, Mikhail Ryazanskiy, Nikolay Pilyugin, Sergey Korolev, Valentin Glushko, Vladimir Barmin, and Viktor Kuznetsov. Most reproductions of this picture have Bogornolov on the left cropped off because he was not one of the original members of the council from the 1940s. (files of Asif Siddiqi)

¹³⁸ B. Konovalov, "Dash to the Stars" (English title), *Izvestiya*, October 1, 1987, p. 3; B. Konovalov, "Lessons of the First Satellite" (English title), *Izvestiya*, September 29, 1987, p. 3

¹³⁹ Konovalov, "Lessons of the First Satellite."

In the original 1959 letter of Korolev and Keldysh to the government on organizing for the space program, they had laid out a number of potential options, all of which implied a formal separation of the space program from the ballistic missile program. The central tenet of their proposal was the formation of a dedicated scientific research institution focused exclusively on the exploration of space. By 1961, even after the euphoria surrounding Gagarin's flight, few of their proposals were implemented. The only visible manifestation that the Soviet leadership was interested in space as separate from military policy was the formation of the *ad hoc* Interdepartmental Scientific-Technical Council for Space Research within the Academy of Sciences. OKB-1, the most dominant space organization in the immediate post-Sputnik era, continued to maintain its multitude of ballistic missile programs as its primary *raison d'être*. Augmented by the addition of a number of subsidiaries and branches in the recent past, Korolev was overseeing about 15,000 employees in 1961, far more than any other design bureau in the field.¹⁴⁰ OKB-1 also served as a tool for foreign policy. In August 1958, a group of senior engineers from the design bureau were sent to China, along with some R-2 missiles, to assist the Chinese ballistic missile program. Although the team returned to the Soviet Union in early 1960, the exchange was a significant boon to Chinese aspirations to develop a strategic force and to aid in the emergence of the future Chinese space program.¹⁴¹

A Day in the Life

Gagarin's flight had been a singular event in the planning of the Vostok program. Although there were orders for the manufacture of many more Vostok spacecraft, actual plans for subsequent piloted missions were remarkably vague. Unlike the Mercury effort in the United States, the Soviet program essentially advanced in stops and starts. From the outside, all of the missions, of course, seemed as if they were parts of a well-planned program, but in truth the missions were formulated as the project advanced. Vague plans for the second piloted Vostok flight dated back to early 1961, when conceptions were focused on a daylong mission. These ideas were the subject of vigorous discussion at the Sochi resort on the Black Sea in mid-May, where Korolev, his wife, all the cosmonauts, physicians, Air Force officers, and cosmonaut trainers

¹⁴⁰ The first OKB-1 branch was located at Ostashkov-3 on the island of Corodomlya, where the German scientists captured after the war developed their own missile proposals. This subsidiary, called OKB-1 Branch No. 1, was established in 1957 to design gyroscopes. See Margarita Shii, "Secrets of Island N: What Are They Doing on the Island of Corodomlya? Some Say They Are Producing Bacteriological Weapons. Others—Strategic Missiles" (English title), *Nouoye vremya* 30 (July 1993): 16–17. A second subsidiary, OKB-1 Branch No. 2, was established on June 4, 1959, at Plant No. 1001 in Krasnoyarsk-26, under the leadership of Deputy Chief Designer M. F. Reshetnev, to oversee the manufacturing of the R-9 ICBM. On December 18, 1961, the branch was formally separated from OKB-1 and became the independent OKB-10. Its initial focus was design and manufacturing oversight over ICBMs, but in 1962, it began to design and develop its own satellites. In later years, as NPO Prikalnoy mekhaniki, it became one of the largest developers of satellites in the world, focusing primarily on communications satellites. See S. Colotyuk, "Anniversaries: After Thirty Years and a Thousand Satellites (On the Anniversary of the Launch of the First Spacecraft Developed at the NPO Applied Mechanics at Krasnoyarsk-26)" (English title), *Novostr kosmonavtika* 17 (August 13–26, 1994): 42–43. The third subsidiary of OKB-1 was established at Kuybyshev to produce the R-7 ICBM. On April 3, 1958, the manufacturing of the missile was moved to the State Aviation Plant No. 1. Later on July 23, 1959, the Serial-Design Department No. 25 was established on the premises of the plant to oversee R-7 manufacturing and upgrades. On July 17, 1960, this department became OKB-1 Branch No. 3 under the leadership of Deputy Chief Designer D. I. Kozlov. The latter had earlier served as the "lead designer" of the R-5 and R-7 missiles. See V. M. Drebkova, "On the Anniversary of the TsSKB" (English title), *Novosti kosmonavtikr* 15 (July 16–29, 1994): 43–44. An additional branch, although not designated as such, was established on July 3, 1959, at Kaliningrad at the former Central Scientific-Research Institute No. 58 (TsNII-58). It was headed by OKB-1 Deputy Chief Designer K. D. Bushuyev. See Semenov, ed., *Raketno-Kosmicheskaya Korporatsiya*, p. 633.

¹⁴¹ A. V. Ponomarev, "24 April—20 Years From the Launch of the First Chinese Rocket-Carrier 'Long March-1' with the Satellite 'China-1'" (English title), *Iz istorii aviatsii i kosmonavtiki* 64 (1990): 30–33.

went on a well-earned vacation after Gagarin's mission. In the process of formulating plans for the following mission, discussions ended in a deadlock as Korolev insisted that the flight last a complete day. On the other side, Kamanin, the biomedicine specialists, and the cosmonauts themselves were inclined toward a more modest three- to four-orbit flight with a landing in eastern Soviet Union. Buoyed by the success of Gagarin, and unwilling to carry out what he saw as only an incremental advance, Korolev refused to back down. Unknown to anyone present at Sochi, Korolev was so sure that his one-day proposal would be approved that he had already summoned Deputy Chief Designer Bushuyev to Sochi to begin preparations for the longer plan.¹⁴²

The conflict eventually spilled over to the General Staff level within the Soviet Air Force, which had nominal control over the cosmonauts. Air Force Deputy Commander-in-Chief Agaltsov convened a meeting in June with some of the most prominent physicians in the space medicine field: Oleg G. Gazonko, Nikolay N. Gurovskiy, Norair M. Sisakyan, Vasiliy V. Parin, Vladimir I. Yazdovskiy, Yevgeniy M. Yuganov, and others. Also in attendance were the six core cosmonauts and Cosmonaut Training Center Director Karpov. All the physicians unanimously supported the triple-orbit (or five-hour) option; even Gagarin, who had recently been named the commander of the cosmonaut group, offered his full support. When Korolev heard the news, he was indignant. The matter was eventually taken to the ministerial level and decided by State Committee for Defense Technology Chairman Smirnov. Korolev had his way: the mission was planned for a full twenty-four hours and seventeen orbits."¹⁴³

Titov, Gagarin's backup for the first mission, was considered a natural choice for the flight. Said to have been a much more sophisticated and worldly person than the shy and uncomplicated Gagarin, Titov was one of the most well-read and astute cosmonauts on the team, as adept as quoting Hemingway as he was in the technical arcana of rocketry. His individualistic streak lent itself to many a conflict with the cosmonaut physicians, who were as notorious in their search for problems to bar candidates from flight as the ones in the United States. In selecting Titov's own backup, the most likely choice would have been Nelyubov, but Titov apparently had been irritated by Nelyubov's constant wishes to move ahead in the cosmonaut roster. Kamanin dropped him from consideration and instead moved in Nikolayev as the backup. This would be the first of many times that Nelyubov would be the center of a "personality conflict." In early June 1961, a new State Commission, headed by Smirnov, convened to discuss details of the flight, tentatively approving Titov and Nikolayev as the likely candidates. The launch was provisionally set for August, only two months later.¹⁴⁴

Once all the parties agreed on the length of the mission, Keldysh, Korolev, Kamanin, and Mozhorin signed a detailed technical document on mission objectives on July 7, 1961.¹⁴⁵ The primary goal of the mission would be the accomplishment of an orbital piloted space mission lasting seventeen orbits with a landing on the start of the eighteenth. In addition, six specific objectives were listed:

142. Kamanin, *Skrytiy kosmos*, p. 56; Golovanov, Korolev, p. 666.

143. Golovanov, Korolev, pp. 667-68. Gagarin had been appointed commander of the military unit no. 26266 (the cosmonaut team) on May 25, 1961. See Sergey A. Voevodin, *VSA053*, October 23, 1994, newsletter on the Internet.

144. Golovanov, Korolev, p. 666, William Shelton, *Soviet Space Exploration: The First Decade* (New York: Washington Square Press, 1968), pp. 102-04; Aleksandr Romanov, Korolev (Moscow: Molodaya gvardiya, 1996), p. 420.

145. This document has been reproduced in full as M. V. Keldysh, S. P. Korolev, N. P. Kamanin, and Yu. A. Mozhorin, "On the Flight of the 'Vostok-2' Space Ship" (English title), in Avduyevskiy and Eneyev, eds., *M. V. Keldysh. izbrannyye trudi*, pp. 418-20.

- Research on a human conducting extended flight in orbit and landing
- Verifying the possibility of accomplishing manual orientation of the spacecraft and evaluating the possibility of return with the use of manual control
- Research on the working capabilities of a human in conditions of extended stay in a state of weightlessness
- Performing direct communications with ground points by the Zarya radio-telephone line
- The use of a film camera aboard the spacecraft by the pilot
- Observations via the porthole with the aid of simple optical instruments¹⁴⁶

Various emergency modes of landing were also described in the document.

The timing of the mission was the source of some unusual dynamics. In mid-July, Khrushchev had invited Korolev and a number of other prominent chief designers to meet with him during a vacation in Crimea. Korolev told the Soviet leader that a second Vostok mission was under preparation. At the end of the meeting, Khrushchev casually added that Titov's launch should occur no later than August 10.¹⁴⁷ Korolev assured him that this would be so, although at the time he clearly had no understanding of why Khrushchev would make such an unusual request. Later, in mid-August, the reason was absolutely clear: the building of the Berlin Wall began on August 13, and Khrushchev had wanted to give the socialist world something of a moral boost at a time of great crisis.¹⁴⁸ While it was not the first case in which Khrushchev had suggested a particular time for a specific launch, it was clearly the first occasion in which the launch of a mission was timed to play a major role in the implementation of Soviet foreign policy.

There was some concern about the launch date because of heavy solar activity in mid-July, but these storms abated soon after, and the flight was set to start on August 6. In much the same way as for the earlier flight, the cosmonauts arrived at Tyura-Tam a few days prior and were present at various State Commission meetings to review the course of launch preparations. There was only a minor hitch during prelaunch operations when there was a leak in the core stage of the booster—a problem that was swiftly handled by Korolev's Deputy Voskresenskiy. On the morning of August 6, Titov and Nikolayev were taken by bus to the pad at site 1. Again, formalities and farewell speeches were kept to a minimum. With an exclamatory "She's off and running!" the twenty-five-year-old Major German S. Titov lifted off at 0900 hours Moscow Time on top of a thundering 8K72K booster and headed straight for orbit from the steppes of Kazakhstan. Orbital insertion occurred without problem. Unlike Cagarin's flight, booster performance was nominal, and the spacecraft, renamed Vostok 2, reached its slated 178-by-257-kilometer orbit inclined at 64.93 degrees. Immediately after entering orbit, Titov began to feel disoriented. As he later described, he felt as he was flying upside down, as if he was turning in a somersault with his legs up. He recalled that he was in a "strange fog," unable to identify Earth from the sky or to read his instrument panel.¹⁴⁹ Titov apparently tried

¹⁴⁶ The cosmonaut would have the opportunity to make an independent decision to land by using the orientation system manually on the fourth, fifth, and seventeenth orbits. The spacecraft could be automatically returned on the third or sixth orbit. If landing at the beginning of the eighteenth orbit failed, then the pilot would have the opportunity to land by manual orientation on each of the nineteenth to twenty-second orbits.

¹⁴⁷ Khrushchev, *Nikita Khrushchev*, torn 2, pp. 124–25.

¹⁴⁸ Korolev's First Deputy Mishin later also confirmed that the Vostok 2 mission was timed to coincide with the construction of the Berlin Wall. See G. Salakhutdinov, "Once More About Space" (English title), *Ogonek* 34 (August 18–25, 1990), 4–5.

¹⁴⁹ Golovanov, *Korolev*, pp. 672–73; Shelton, *Soviet Space Exploration*, p. 117; Riabchikov, *Russians in Space*, p. 163; Smolders, *Soviets in Space*, pp. 117–18.



The State Commission for the Vostok 2 mission is shown here before the launch of cosmonaut German Titov. In the front row from the left are Academy of Sciences President Mstislav Keldysh, State Commission Chairman Leonid Smirnov, Chief Designer Sergey Korolev, and Chief Designer Vladimir Barmin. (copyright Christian Lardier)

moving sharply in his seat to clear his head, but the upside-down feelings remained. The unpleasant sensations continued to grow, and by the second orbit, he even briefly contemplated asking permission to return to Earth. Aerospace medicine specialists had predicted such sensations for several years, based on research on the inner ear. Doctors believed that otoliths, minute bone concretions that press against the wall of the inner ear as a result of gravity and pass on information on posture, would not provide the same indications to the brain in microgravity, thus causing spatial disorientation.

Doctors on the ground were aware of the situation on the spacecraft from pneumographic, electrocardiographic, and kinetocardiographic sensors on Titov, and on the third orbit, they inquired about his general physical and psychological condition. Titov, resistant to alarm people on the ground, reported, "Everything is in order." As per his preflight instructions, he decided to take his first meal in space at the time of his sixth orbit, a three-course lunch in paste form delivered in tubes. Television pictures beamed to the ground showed Titov with his soup puree, liver pâté, and black currant jam in plastic dispensers. The cosmonaut, who was still reeling from feelings of nausea, elected not to eat much, and only squeezed some black currant juice into his mouth, which eventually made him vomit. Later, he also ate a small piece of bread and peas with added vitamins and drank some water. The meal was, however, extremely unappetizing to the still-suffering cosmonaut, and he took the opportunity to rest for a short while before conducting experiments, manually firing the attitude control jets on the spacecraft. It was the first such experiment on a Soviet space vehicle, and Titov encountered no problems during the two occasions he took over manual control, on the first and seventh orbits of his mission. He was scheduled to begin his sleep period at the end of the seventh orbit, but as he

later reported. "I was having a difficult time maintaining a sense of balance."¹⁵⁰ Kamanin recalled in his diaries that the scope of Titov's discomfort was fairly serious and included "vertigo, nausea, aches in the head and eyes, disorders of the vestibular system. [and] loss of appetite."¹⁵¹ At 1815 hours, he passed over Moscow and reported. "Now I'm going to lie down and sleep. You can think what you want, but I'm going to sleep."¹⁵² Sleep rules necessitated that his helmet visor be closed at all times, but Titov was feeling incredibly stuffy inside his helmet, and feared that if he had to vomit, it might pose a hazard. He attached a piece of string to immediately jerk open the visor in case of an emergency while asleep.

Except for two minor incidents of waking up (on the tenth and eleventh orbits). Titov rested peacefully. He overslept by about thirty-five minutes, waking at 0237 hours on August 7 on his twelfth orbit. Contrary to most Western reports, the hapless cosmonaut felt just as worse after waking up: he still felt worn out and had a headache. He tried some cursory experiments, such as handwriting, opening and shutting his eyes, and testing coordination, and he was encouraged to observe that his reflexes were much better than during the first portion of the flight, although the "strange fog" was still with him. He also drank a little liquid chocolate, but immediately regurgitated what little food he had in his stomach. Having reached the nadir of his daylong excursion into space, for inexplicable reasons, at the end of his twelfth orbit, he suddenly began to feel better. With each passing minute, his outlook on the mission began to improve, and by the later orbits, he was completely functional and fully fit."¹⁵³

Among the experiments that he *did* manage to conduct included the use of the special *Konvas* movie camera to take a ten-minute-long movie of Earth's horizon when both entering and exiting from Earth's shadow. Despite a malfunctioning exposure meter, the results of the experiment were fairly impressive, and they were later published in the Soviet media amid much fanfare. He also used a special optical sight named *Zritel*, which provided magnifications of three to five times over the naked eye. Internal TV cameras were improved from Gagarin's mission. Of the two cameras, one had a resolution of 400 lines over the 100 lines on the first Vostok. Both had a capacity of ten pictures per second. Another difference with the Gagarin capsule was the use of a new cabin atmosphere regeneration system. There were no major technical anomalies during the orbital phase of the mission, although at one point the temperature apparently dropped to ten degrees Centigrade. Engineers later found that both the primary and backup cooling fans had been inadvertently turned on at launch, thus causing the cool temperatures."¹⁵⁴

The reentry was as traumatic as the first Vostok mission. After retrofire, Titov heard a loud crack, indicating that the two compartments of the spacecraft had separated. Soon after, however, he heard a light rapping sound and realized that the instrument section was still attached to the spherical descent apparatus by means of several straps. In a situation uncannily similar to Gagarin's return, the two wobbling modules reentered Earth's atmosphere, with the instrument section eventually burning up."¹⁵⁵ Titov ejected safely from his capsule and landed without further incident at 1018 hours near the village of Krasnyi Kut in the Saratovskaya Oblast after a record flight of one day, one hour, and eleven minutes.

The young cosmonaut was in a fit of euphoria after landing, and on the flight back to Kuybyshev for the postflight briefing, he talked excitedly of his flight. To the alarm of accompanying doctors, he opened up a beer and downed it quickly in complete violation of postflight codes. At the briefing, Titov was candid about all the problems he had encountered, describ-

150 Shelton, *Soviet Space Exploration*, p. 121.

151 L. Kamanin, "Work in the First Two Years Space Diary" (English title), *Pravda*, April 8, 1991, p. 2.

152 Riabchikov, *Russians in Space*, p. 168.

153 Golovanov, Korolev, pp. 673-74.

154 Kamanin, *Skrytiy kosmos*, p. 84.

155 Golovanov, Korolev, p. 674.

ing in great detail his experience with motion sickness. None of this was, of course, reported publicly at the time. In later summaries of the mission, Soviet journalists downplayed the extent to which Titov had suffered from discomfort during the flight. It was said that Korolev himself had been greatly perturbed by Titov's experience. At the time, there was little unanimity in the causes of his sickness. Some physicians were inclined to attribute the problems to the length of the mission, others to Titov's particular physiological makeup. Clearly, it raised the concerns of both engineers and physicians on proceeding with longer missions. Titov himself suffered no permanent effects of his tribulations, and like Gagarin before him, he was sent off on a requisite world trip, a traveling advertisement for the Soviet Union. By the end of 1961, Gagarin and Titov, escorted by Kamanin, had visited Afghanistan, Brazil, Canada, Ceylon, Cuba, Czechoslovakia, India, Finland, Hungary, Iceland, and the United Kingdom, with many more countries to come in 1962.

It seems that the trials of dealing with instant fame caught up with both these young men. They were both severely disciplined at a Communist Party meeting on November 14 for "acknowledged cases of excessive drinking, loose behavior towards women, and other offenses."¹⁵⁶ In what seems to have been a case of womanizing, in mid-October, Gagarin jumped out of a window of a young woman's room at a resort when his wife came knocking. He sustained a severe injury on his forehead, which left him in a hospital for a while. All photos of the cosmonaut past that point show a deep scar over his left eye. Gagarin later explained to the Soviet press that he had fallen down while playing with his daughter, adding "it will heal . . . before my next space flight."¹⁵⁷

As the scars of the Soviet space program remained hidden, the public face was a massive propaganda juggernaut aimed at consolidating the image of the Communist Party. In 1961, the Soviets had reason to exult. They had launched two men into orbit, the second for a full day, opening the era of human spaceflight. On the other side, the United States had little reason to celebrate. The first American in space, thirty-eight-year-old Navy Lt. Commander Alan B. Shepard, Jr., was launched on May 5, 1961, in a Mercury spacecraft.¹⁵⁸ Whereas Gagarin had flown a complete orbit, twenty-three days later, all NASA could manage was a fifteen-minute, twenty-two-second suborbital hop into space. A second similar flight in July by Major Virgil I. Crissom II was meager consolation. The Soviets had consistently preempted the United States in every major endeavor in space, and Khrushchev continued to take personal credit for the accomplishments. Soon after Titov's flight, and a week after the building of the Berlin Wall, the official Communist Party newspaper *Pravda* reported:

[Khrushchev] participates in the discussion of all the most *vital* experiments, directs the development of the major directions of technical progress in the country, and the determination of the basic directions and establishment of generally planned growth of space science and technology. In his able proposals, there is evidence again and again of the great conviction in the triumph of Soviet rocket technology.¹⁵⁹

In contrast, at least in the eyes of the world, the U.S. space program had been lacking in strong leadership since the immediate aftermath of Sputnik.

156. Kamanin, *Skrytiy kozmos*, p. 66.

157. *Ibid.*

158. Linda Neumann Ezell, *NASA Historical Data Book: Volume II Programs and Projects 1958-1968* (Washington, DC: NASA Special Publication (SP)-4012, 1988), p. 143

159. Vladimir Orlov, *Pravda* (August 26, 1961), referenced in Nicholas Daniloff, *The Kremlin and the Cosmos* (New York: Alfred A. Knopf, 1972), p. 73

NASA which was the most visible manifestation of the U.S. desire to explore space had formulated a long-range plan by 1959, which among other goals called for "the manned flight of the moon and the nearby orbit."¹⁶⁰ A preliminary schedule for the "First launching in a program leading to an earth-circumlunar flight and to [a] permanent near earth station" was 1965-67. This actual "manned flight to the moon" was left to "By 1970" President Eisenhower, while very much cognizant that a vigorous space race with the Soviet Union had emerged, was clearly unwilling to commit resources to win it at any cost. This impasse changed dramatically by the early spring of 1961 as a new Democratic President, John F. Kennedy, and a new NASA Administrator, James E. Webb, took up their responsibilities. Spurred and shocked once again by Gagarin's triumphant single-orbit mission, a flurry of activity ensued, prompted by a memorandum on April 20 in which Kennedy asked Vice President Lyndon B. Johnson for recommendations on activities in space that would provide "dramatic results" and a chance to beat the Soviets.¹⁶¹ After intensive discussion among representatives of NASA, the U.S. Department of Defense, members of Congress, industry, and academia, Johnson's report was formally accepted by Kennedy during a meeting on May 10, five days after Shepard's launch. The report included a call for an unprecedented acceleration of U.S. efforts to explore space, specifically "to pursue projects aimed at enhancing national prestige."¹⁶² Based on this report, Kennedy declared a national objective for the U.S. space program at an unusual second "State of the Union" address to a joint session of Congress on May 25, 1961. In perhaps the most important public policy statement in the history of U.S. space exploration, Kennedy told his audience of a new nationwide program that would restore U.S. prestige:

I believe that this nation should commit itself to achieving the goal, before this decade is out, of landing a man on the Moon and returning him safely to Earth. No single space project in this period will be so difficult or expensive to achieve."

¹⁶⁰ Office of Program Planning and Evaluation, "The Long Range Plan of the National Aeronautics and Space Administration," December 16, 1959, with excerpts published as Document III 2 in John M. Logsdon, general editor, with Linda J. Lear, Janelle Warren, Findley Ray A. Williamson, and Dwayne A. Day, *Exploring the Unknown: Selected Documents in the History of the US Civil Space Program, Volume I: Organizing for Exploration* (Washington DC: NASA SP 4407) pp. 403-07.

¹⁶¹ John F. Kennedy Memorandum for Vice President, April 20, 1961, published as Document III 6 in *ibid.* I, 423-24.

¹⁶² James E. Webb, NASA Administrator, and Robert S. McNamara, Secretary of Defense, to the Vice President, May 8, 1961, with attached "Recommendations for Our National Space Program: Changes, Policies, Goals," published as Document III 1 in *ibid.* I, 439-52.

¹⁶³ U.S. Congress, Senate Committee on Aeronautical and Space Sciences, *Documents on International Aspects of the Exploration and Uses of Outer Space, 1954-1962*, 88th Cong., 1st sess., S. Doc. 18 (Washington DC: U.S. Government Printing Office, 1963) pp. 202-04.



Second cosmonaut German Titov (right) appears with NASA astronaut John Glenn and President John Kennedy at the White House in 1962. The twenty-two-year-old Titov was the youngest person to ever go into space—a record that still stands to this day (files of Asif Siddiqi)

Kennedy's speech on May 25, 1961, was a declaration of a national objective; there was no explicit indication in the language that the United States would have to get to the Moon first, only that an American should stand on the Moon before January 1, 1970. But implicit in his declaration was also a challenge—a challenge not only to "every scientist, every engineer, every serviceman, every technician, contractor, and civil servant" to harness capabilities in this great endeavor, but also a challenge to the Soviet Union itself.

From the Soviet perspective, this challenge was not perceived as such. From the beginning of the space era, the Soviets had been in the position to make the challenges, with the spectacular launches of a plethora of Sputniks, Lunas, and Vostoks. Given the rigorous secrecy that pervaded their space efforts, it would have been unusual for them to announce these projects in advance. Every challenge was manifested in hardware, in launches, and in accomplishments. The speeches came afterwards. The United States, of course, also responded with hardware, but all of them—Vanguard, Explorer, and Mercury—paled in the eyes of the public to Soviet accomplishments. Thus for the Soviet Union, on May 25, 1961, the dimensions of the space race changed little. Kennedy's speech was in fact not even widely reported in the Soviet media, and few in the space program took notice.⁶⁴ There were no major reassessments of Soviet goals and plans for space exploration. It was, after all, only a speech, and in the mind of the Soviet citizen, speeches were better left to celebrate victories, not plans for victories. What was a momentous occasion in U.S. space policy thus passed without a response in the Soviet Union. The Soviets never guessed that regardless of Kennedy's own commitment to space exploration, the wheels of a mammoth and well-oiled machine had been set into motion—one that would eventually humiliate the great Soviet space program of Sputnik and Vostok.

164 Interview, Georgiy Stepanovich Vetrov with the author. November 15, 1996.

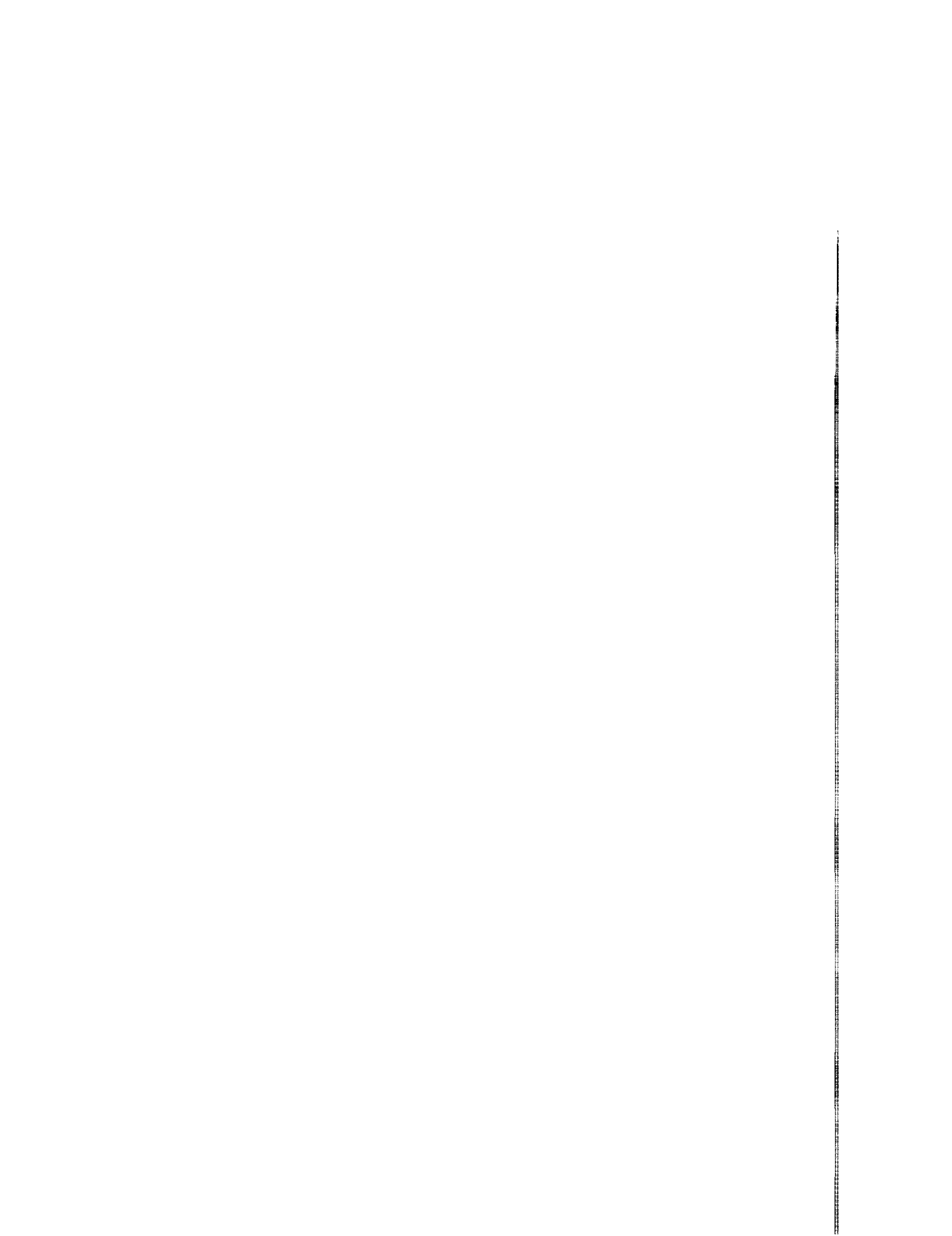



CHAPTER EIGHT LOOKING TO THE FUTURE

There is a tendency in the Western discourse on the Soviet space program to make repeated allusions to "the Soviets." It was always the generic "Soviets" who decided on a particular goal or the "Soviets" who launched a satellite, while in the United States, one could comfortably write about NASA or the Department of Defense. In the face of pervasive secrecy, the inner workings of the program were as unknown as the secrets of the cosmos itself. It was as if there was a monolithic structure located in some far away place, an almost mythological quantity, which ran a program of gargantuan proportions. To a great degree, this myth has remained a fundamental characteristic of the Western writing on the history of the Soviet space program, some of it perhaps derived from the cultural divide in language, custom, and history that separated the Soviet Union from the rest of the world during the Cold War. What this myth did was to obscure a story of fallible people seeped in battles that were all too human. It was never "the Soviets" who made decisions or launched Sputniks, nor was it one single person either. Like any other scientific endeavor, there were different individuals and institutions with varying motivations and histories vying for the same resources. And having reached the absolute zenith of its trajectory in 1961, the Soviet space program was now to face a different kind of battle—one among institutions and individuals. This battle irrevocably altered the course of the Soviet space program.

Chelomey's Reach for Space

The official government decrees in June 1960 were the green light for Vladimir Chelomey's grand entrance into the space program. Khrushchev, perhaps dazzled by Chelomey's sophisticated ways, or simply favoring his son's employer, continued to maintain his unabated support for OKB-52, which grew at an unprecedented pace. This expansion was also abetted by the economic depression in the aviation sector, as numerous design bureaus had to postpone or terminate projects. In fact, with the singular exception of OKB-52, all aviation design entities were forced to curb their efforts. Taking advantage of such an unusual situation, Chelomey literally gobbled up organizations one after another.

The first to come under the Chelomey umbrella was Myasishchev's former OKB-23, which had been attached to OKB-52 in October 1960 as the latter's Branch No. 1. Production at its associated giant factory, the M. V. Khrunichev Machine Building Plant (ZIKh) located in the Fili suburb of Moscow, was now redirected toward manufacturing for Chelomey's various projects. A second factory, Plant No. 642 in Moscow, which briefly series-produced Chelomey's naval cruise missiles, was made the new Branch No. 2 in March 1963 under Deputy General Designer

Vladimir M. Baryshev. The facility was used herein for designing ground equipment for various missiles and spacecraft operations.

Another acquisition was more notable: OKB-301 headed by General Designer Semyon A. Lavochkin, one of the most renowned aviation organizations in the Soviet Union. The beginning of the decade was not a good time for this design bureau. In February 1960, the Soviet government canceled work on the La-350 Burya intercontinental cruise missile. Four months later, Lavochkin was dead of a heart attack. Chelomey took advantage of this weak position. Within days of Lavochkin's death, he invited thirty of the senior-most engineers from OKB-301—the so-called "brain" of the organization—to work for him in Reutov at his own design bureau. Among the relocated individuals was Naum S. Chernyakov, the lead designer for the Burya missile, and N. A. Kheyfits, a well-known pioneer of high-speed flight in the Soviet Union, who was no doubt an asset to Chelomey's burgeoning dreams of winged reusable space vehicles.'

The former Lavochkin design bureau's fortunes continued to decline. In 1962, the Soviet military finally terminated the remaining work on the Dal air defense network for the city of Leningrad. With nowhere to go, OKB-301 finally succumbed to Chelomey's growing power. The Chief of the Defense Industries Department, Ivan D. Serbin, a powerful Chelomey supporter in the Central Committee, agreed to Chelomey's request to take over the entire design bureau. By an executive order dated December 18, 1962, the old Lavochkin bureau at Khimki became the new OKB-52 Branch No. 3.'

These various absorptions allowed Chelomey to spread out all of his work from the central Reutov branch. With a larger number of engineers and more facilities, he was able to take on an incredibly wide range of military work that ran the gamut from naval cruise missiles to ICBMs to spacecraft. By the end of 1962, in terms of personnel, the OKB-52 empire was, in fact, far larger than Korolev's OKB-1, the founder of the Soviet space program."

Chelomey's claims on the space program were to be effected in five different thematic directions. These were the development of:

1. Plant No. 642 was the location of KB-2 between 1946 and 1951 and GSNII-642 between 1951 and 1958. In 1958, GSNII-642 was closed down, and its plant was eventually tasked with producing Chelomey's P-25 naval cruise missile in 1961 and 1962. The new OKB-52 Branch No. 2 was established at Plant No. 642 on the basis of a department for ground equipment for missiles and spacecraft transferred from OKB-52's Branch No. 1. This department was transferred in March 1963. See M. Tarasenko, "35 Years for the OKB 'Vypel'" (English title), *Novosti kosmonavtiki* 8 (1998): 43-44, Aleksandr Shirokorad, "Rakety nad morem," *Tekhnika i uooruzheniye* no. 6 (November-December 1997): 1-80, Christian Lardier, "70 Years of Soviet Ramjets," presented at the 48th International Astronautical Federation, IAA-97-IAA.2.3.03, Turin, Italy, October 6-10, 1997.

2. Sergey Khrushchev, *Nikita Khrushchev krizisy i rakety: vzglyad iznutri*, tom 2 (Moscow: Novosti, 1994), pp. 42-44, Yaroslav Golovanov, "The 'Burya' Which Did Not Break Out" (English title), *Komsomolskaya pravda*, March 18, 1998, p. 3. Among the individuals transferred from OKB-301 were Acting General Designer N. S. Chernyakov, Fedorov, Kheyfits, and Yefimov. See also Mikhail Rudenko, "Designer Chelomey's Rocket Planes" (English title), *Vozdushniy transport* 47 (1995): 8-9. Note that in the last source, the transfer is incorrectly said to have taken place in May 1958.

3. Christian Lardier, *L'Astronautique* Souretique (Paris: Armand Colin, 1992), p. 152. OKB-52 Deputy General Designer A. I. Eidis was appointed to head Branch No. 3 at the time. The branch was to aid in the development of the P-25 surface-launched anti-ship missile, the P-70 Ametist submarine-launched anti-ship missile, the "IS" anti-satellite, and the "US" ocean reconnaissance satellite programs. See S. M. Ganin and V. I. Ivanovskiy, "The Multi-channel 'Dal' Anti-Aircraft Missile System of Great Range" (English title), *Neviskiy bastion* no. 1 (1998): 7-15; Shirokorad, "Rakety nad morem."

4. There may have been a fourth addition to OKB-52 at the time. NII-2, headed by V. A. Dzhaparidze, was said to have been attached to Chelomey's design bureau sometime in the early 1960s. See Andrey Tarasov, "Space Science of the Future: Selection of Paths and Orbits" (English title), *Prauda*, May 17, 1990, p. 3. In addition, the design bureau also had production affiliates at Dubna and Saratov. See Cerbert Aleksandrovich Yefremov, "NPO Mashinostroyeniya is Moving Into the High-Technology Market" (English title), *Vooruzheniye, politika, konuersiya* 3(10) (1995): 31-37.

- A series of new boosters to serve as ICBMs and space launch vehicles
- An automated anti-satellite system
- An automated ocean reconnaissance system
- Spaceplanes for the exploration of near-Earth space
- Spaceplanes for lunar and interplanetary space

The centerpiece of his expanding move into the space sector was the first "theme," specifically the UR-200 ICBM, which the Soviet space leadership approved for preliminary development in June 1960. The Central Committee and the Council of Ministers issued supplementary decrees on its development on March 16 and August 1, 1961.⁵ In a move no doubt intended to ensure full support for the UR-200 project, Chelomey offered up the booster first as a new generation ICBM and then as a space launch vehicle. Chelomey, unlike Korolev, was also not resistant to using hypergolic storable propellants for the missile, thus pacifying powers in the Strategic Missile Forces who were initially alarmed by Chelomey's rapid encroachment into the missile business from the aviation sector.

As Chelomey's reach expanded, he also farmed out his own projects to the OKB-52 branches. While his leading deputies would maintain overall design supervision of particular vehicles, detailed design work would be undertaken by engineers at the branches. In the case of the UR-200, Chelomey gave the project to his new Branch No. 1 at Fili; with Myasishchev now gone, the engineers there resigned themselves to Chelomey's new projects and, in fact, went on to produce some of the most important Soviet space vehicles. The UR-200, formerly called the R-200, was a two-stage vehicle with a total launch mass of 138 tons. Payload capability to low-Earth orbit was limited to four tons, making it somewhat of a light launch vehicle, which is exactly what Chelomey had in mind. Overall length was thirty-five meters with a base diameter of three meters. In its ICBM version, the missile would carry a single warhead ranging from five to fifteen megatons over 10,000–12,000 kilometers.⁶ Instead of Glushko's engines, which were standard for all long-range Soviet ballistic missiles, Chelomey contracted an aviation organization, OKB-154 headed by Chief Designer Semyon Kosberg, to design the new engines for the rocket. It was another step forward into the space business for Kosberg, whose first successful contribution to the Soviet space program was to design the upper stage engines for boosters that had launched the Lunas and Vostoks into orbit.⁷ All the engines for the UR-200 used toxic components, specifically nitrogen tetroxide and unsymmetrical dimethyl hydrazine (UDMH).⁸

5 I Afanasyev '35 Years for the Proton RN' (English title) *Novosti kosmonavtiki* 1-2 (1998) 45-48

6 Mikhail Rudenko 'Designer Chelomey's Rocket Planes' (English title) *Vozdushnyi transport* 48-49 (1995) 8-9 A V Karpenko *Rossiyskiye raketnoye oruzhiye 1943-1993gg* (St Petersburg PIKA 1993) p 12 Ye B Volkov ed *Mezhkontinentalnyye ballisticheskiye rakety SSSR (RF) i SShA* (Moscow RVSN 1996) p 322

7 The UR 200 was powered by the RD 0202 engine on the first stage and the RD 0205 engine on the second stage. The RD 0202 itself was composed of three RD 0203 engines and one RD 0204 engine while the RD 0205 was composed of the RD 0206 sustainer and RD 0207 vernier. Total first stage thrust was about 200 tons. The development of these engines began in March 1961. See Vladimir Rachuk 'Best Rocket Engines from Voronezh' *Aerospace Journal* no. 6 (November-December 1996) 30-33 'Engines for Combat Missiles' *Russian Space Bulletin* 4(3) (1997) 13-15 KB *KhimAvtomatiki Stranitsy istorii tom 1* (Voronezh KB KhimAvtomatiki 1995) pp 51-54

8 Apart from use as a space launch vehicle and an ICBM, the UR 200 was also the focus of two other proposals. In July 1961 Chelomey offered up the missile as an orbital bombardment system that could drop nuclear warheads on enemy targets from orbit. In this variant, the missile would be called the Global Missile No. 1 (GR 1). Later in February 1962 a second proposal involved UR 200s equipped with guided ballistic warheads, which would reenter from orbit and guide themselves with aerodynamic surfaces to U.S. naval ships that were seen as a threat to the Soviet Navy. While work on both these proposals was undertaken to a preliminary stage like many of Chelomey's projects, they were never finished. See Khrushchev *Nikita Khrushchev tom 2* pp 122-155

The UR-200 was only the first step in Chelomey's plans for a series of new ICBMs and space launch vehicles. Planning at his design bureau showed that to meet Chelomey's more grand plans for space exploration, he would need a second booster that could lift as much as twenty tons into orbit. Possible payloads would include piloted spaceplanes, space stations, and large military payloads. In late 1960, concurrent with the addition of Branch No. 1 to OKB-52, Chelomey's deputies began preliminary planning work on a new ICBM with a space booster that would have a capacity for launching heavy payloads into Earth's orbit. This vehicle would eventually emerge as one of the most important launch vehicles ever created in the Soviet space program, the Proton booster. Chelomey picked Pavel A. Ivensen, an old acquaintance of Korolev's from the late 1920s, to lead the project to develop the rocket. Ivensen, like Korolev, had been thrown into prison in the mid-1930s, and he was rehabilitated only in 1956. In the late 1950s, he initially worked on high-speed reconnaissance aircraft at the Tsybin design bureau, but the confusing series of changes in the aviation industry led him first to the Myasishchev organization and finally to work under Chelomey.⁹

In Ivensen's preliminary research on the possible designs for the booster, he made maximal use of technology from the smaller UR-200 as well as Myasishchev's own abandoned M-1 launch vehicle. The new rocket, designated UR-500 in design documentation, was planned from the very beginning as a two-stage ICBM and a three-stage space launch vehicle. At the time, Chelomey's engineers were closely watching the development of the American Titan I ICBM: in many ways, the UR-500 was positioned as a parallel development with similar capabilities and equivalent possibilities for turning it into a heavy-lift launch vehicle. Ivensen's team studied a number of different possible designs for the first stage, including grouping together four two-stage UR-200 rockets together with a third stage, that itself would be a modified UR-200 second stage.¹⁰ What emerged by 1963 was an unusual plan to cluster six long cylindrical propellant tanks around a central cylindrical tank. Unlike parallel-staged vehicles in which each strap-on was a self-contained unit, in the UR-500, the central cylinder would carry all the oxidizer while the tanks on the outside would carry the fuel. Thus, although it visually resembled a strap-on-type booster, the vehicle in fact had a standard tandem-type first stage with clustered tanks. There would be a single powerful engine at the base of each tank powered by



Chief Designer Semyon Kosberg designed numerous upper stage engines for Soviet space launch vehicles. He closely cooperated with Vladimir Chelomey in developing the UR-100, UR-200, and UR-500 ICBMs (files of Peter Gorin)

9 G. Amiryants, "Ivensen's 'Chayka'" (English title). *Aviatsiya i kosmonavtika* no. 4 (April 1990): 36-38. M. Yakovenko, "The Subterranean, Earthly, and Heavenly Creations of Ivensen" (English title). *Nauka i zhizn* no. 9 (September 1991): 20-27.

10. For descriptions of various early conceptions of the UR-500, see Afanasyev, "35 Years for the 'Proton' RN "

nitrogen tetroxide and UDMH, the same high-boiling propellants as the smaller UR-200.¹¹ The diameter of the central tank was limited to just above four meters; this was the maximum dimension that the Soviet railway system could accommodate for transportation from the manufacturing plant to the launch site. In its ICBM version, the UR-500 was designed to have a standard cylindrical second stage with four engines; a third stage would be added in the projected space launch vehicle version. Both these upper stages would have design antecedents in the smaller UR-200 ICBM.

Chelomey's choice of storable propellants was clearly related to his plans to use the UR-500 as an ICBM. Such propellants, he believed, would also significantly simplify engine design because the components would be hypergolic—that is, self-igniting. Having decided on the basic design scheme and the choice of propellants, the next step was to choose a subcontractor. In late 1961, there was only one organization in the Soviet Union designing extremely high-thrust rocket engines for ICBMs: Glushko's OKB-456. At the time, Chelomey was fortuitously placed to take advantage of the increasing acrimony between Korolev and Glushko, which was beginning to incapacitate Korolev's grander plans of space exploration. As the bickering between the two reached a critical point, Chelomey stepped in. In November 1961, he sent a group of three senior engineers from Branch No. 1 on a visit to Glushko's enterprise to explore the possibility of cooperating on the UR-500.¹² Glushko took the chance, perhaps to prove to Korolev once again that he was not dependent on the latter for anything, and he signed an agreement to deliver to Chelomey the first-stage engines for the UR-500. In what may have been additional insult to Korolev, Glushko simply took the engines that he had offered for Korolev's giant N1 booster, modified them a little bit, and offered them to Chelomey. With six similar RD-253 engines firing at liftoff, the UR-500 missile would develop a total thrust of about 900 tons at launch, far in excess of any rocket in the world at the time."

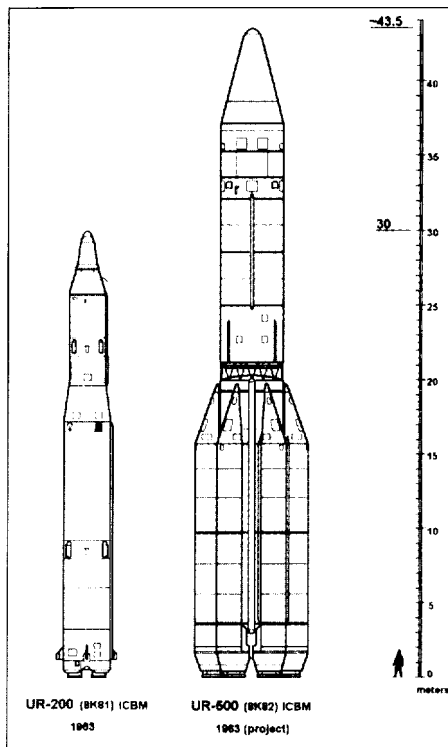

This shows the original variants of the UR-200 and UR-500 ICBMs as conceived by Vladimir Chelomey in the early 1960s. (copyright Peter Corin)

11. V. A. Vyrodov, M. K. Mishetyan, and V. M. Petrakov. "16 July—25 Years From the Time of the Start of Operations of the 'Proton' Rocket-Carrier" (English title), *Iz istorii aviatsii i kosmonavtiki* 64 (1993): 58-67; G. Maksimov. "Space Flight Support: The Proton Launch Vehicle" (English title), *Aviatsiya i kosmonavtika* no. 8 (August 1988) 40-41. In the early version of UR-500 missile, the first stage had four powerful Glushko engines on the core and one gimbaled low-thrust Kosberg engine on each of four strap-ons.

12. V. Petrakov and I. Alanasyev. "'Proton' Passion" (English title), *Aviatsiya i kosmonavtika* no. 4 (April 1993), 10-12; Vyrodov, Mishetyan, and Petrakov. "16 July—25 Years From the Time of the Start" The individuals who visited were D. A. Polukhin (Chief of the Complex for Engine Units), V. A. Vyrodov (Lead Designer of the project), and G. D. DERNYCHEV (Chief of the Planning Department).

13. Petrakov and Afanasyev. "'Proton' Passion"

Glushko was taking a gamble in agreeing to produce these engines, the first "closed cycle" engines in the Soviet Union using storable propellants. Known in the West as "staged combustion cycle" engines. Glushko had had little luck with such motors since the failure of the RD-110 in the early 1950s. A technology demonstrator built at NII-1 in 1958-59 instilled growing confidence that the task could be accomplished. The relatively high-performance characteristics demanded by Chelomey's designers were principally because of the selection of the closed cycle scheme, which would allow extremely high chamber pressures to be derived without losses in specific impulse, thus adding significantly to performance. Glushko addressed this problem by installing the turbines for operating the fuel pumps inside the combustion chamber of the gas generator. During firing, the chamber would receive the full amount of oxidizer, but only a part of the fuel. This mixture would then burn in the preliminary combustion chamber at a relatively low temperature, thus driving the turbine. Later, the combustion gas would enter the main combustion chamber of the engine, where the remaining fuel would be added. The resulting reaction would be a total burning of the propellant components. With this layout, power used to drive the turbines could be reduced to nonexistent levels, while combustion pressure would be dramatically increased without losses of propellant. Finally, Glushko's feared combustion oscillations would be eliminated because of the extremely high temperatures of burning.¹⁴ For Soviet engine design technology, this would be a new step forward; Chelomey, ever the ambitious scientist, took the idea and banked his future on it.

For the upper stages, Chelomey contracted Kosberg once again. The engines slated for the second and third stages of the UR-500 were, in fact, very similar to the ones earmarked for the first two stages of the smaller UR-200 booster." In effect, the larger UR-500 was simply a new huge first stage with a thinner version of the UR-200 (albeit with modified engines) sitting on top of it. This sort of design decision, whereby "each of [their] launch vehicles was supposed to become part of a more powerful one," was a conscious design strategy of the Chelomey people, who held the belief that incremental testing of components separately was a more pragmatic idea in the face of technological and manufacturing limitations of the Soviet defense industry.¹⁶ Thus, by extension, there were even preliminary plans at the time to use the UR-500 itself as the upper stages of an even bigger booster, one to launch hundreds of tons into Earth's orbit.

The development of the large UR-500 booster advanced very quickly along with work on the UR-200 and Chelomey's first automated satellite projects, the "IS" anti-satellite system and the "US" naval reconnaissance system. During a meeting with Khrushchev in February 1962 at the vacation resort of Pitsunda, Chelomey for the first time acquainted the Soviet leader with the UR-500 proposal. In a perfect example of how chief designers went about "selling" their space projects to the Soviet leadership, Chelomey introduced the UR-500 not as a space launch

¹⁴ Peter Stache *Soviet Rockets* Foreign Technology Division Translation FTD ID(RS)T 0619 88 (from unnamed source) Wright Patterson Air Force Base Dayton Ohio November 29 1988 p 405 This is a translation of Peter Stache *Sowjetischer Raketen* (Berlin: Militärverlag der DDR 1987)

¹⁵ In the initial variant of the UR 500 the second stage consisted of three RD 0208 engines and one RD 0209 engine. Each had a vacuum thrust of about sixty tons. When the three stage variant of the UR 500 was introduced new engines were used on the second stage three RD 0210 engines and one RD 0211 engine. For the three stage UR 500 (called UR 500K) the third stage would be equipped with a single RD-0212 engine which consisted of the primary RD 0213 engine and the RD 0214 verniers. Total vacuum thrust would be sixty two tons. See T. Varfolomeyev 'Readers Letters On Rocket Engines from the KB of S. A. Kosberg and Carriers to Which They Were Installed' (English title) *Novosti kosmonautiki* 26 (December 18-31 1993) 46-48 *KB KhimAutomatiki* tom 7 pp 54-55

¹⁶ The quote is from Dmitriy Khrapovitskiy 'Absolutely Unclassified The Ground Waves of Space Politics' (English title) *Soyuz IS* (April 1990) 15

vehicle, but as a super-powerful ICBM named the CR-2, capable of launching warheads of thirty megatons at the enemy. The warhead would be launched into Earth orbit and eventually deorbited at the appropriate time to reach the target. Military-Industrial Commission Chairman Ustinov, who loathed Chelomey, was categorically against the idea. In the end, Khrushchev, perhaps dazzled by the booster's military applications and persuaded by aviation "minister" Dementyev's arguments, agreed to the proposal, asking both Ustinov and Dementyev to draw up the necessary documents for moving ahead with the project." Less than three months later, on April 29, 1962, the Council of Ministers and the Central Committee issued a decree formally approving the UR-500 ICBM and space launch vehicle.¹⁷ Within a month, Chelomey's engineers froze the final design scheme of the vehicle. The rocket, in its various models, would be ready in three years. While the principal design of the vehicle would be focused at Branch No. 1, manufacturing would be undertaken at the giant M. V. Khrunichev Machine Building Plant, which was essentially at Chelomey's disposal by this time."

The UR-200 and UR-500 boosters were only the *means* by which Chelomey intended to undertake his assault into space. The actual payloads would consist of a variety of different sized spacecraft for a wide array of goals. From Chelomey's own perspective, perhaps the most important projects he worked on during the early 1960s were his spaceplanes, subsumed under two different thematic directions, the Kosmoplan and the Raketoplan. The research on the Raketoplan-Kosmoplan theme was evidently conducted in a remarkably haphazard manner. Sergey N. Khrushchev, the Soviet leader's son who was the deputy chief of a department at OKB-52, recalled later Chelomey's idiosyncratic behavior regarding the Kosmoplan-Raketoplan themes:

[He would say] "let's try to make the Kosmoplan using nuclear engines." and then in two weeks there would be another idea, some [more] drawings, some [more] calculations, and then he would say that, "No, this is crazy, it'll never work, forget about it . . . let's try plasma [engines] and this time we'll fly to Mars!"

Irrespective of Chelomey's own whims, the project was real, and hardware was built. It would, in fact, not be an overstatement to say that of all Chelomey's space-related projects through his long career, the spaceplane work held the greatest emotional resonance for him. He would pursue this dream almost continuously unabated for close to a quarter of a century.

Funding for preliminary research on the Kosmoplan-Raketoplan theme was approved in the same June 1960 government decree that accelerated the Soviet space program on a wide range of thematic directions." The degree of state commitment to these ambitious projects remains open to interpretation, but a few recollections suggest that it was significant. Georgiy N. Pashkov, a Deputy Chairman of the Military-Industrial Commission, recalled in 1989 that:

17 Khrushchev. *Nikita Khrushchev* tom 2, pp. 157-58

18 Vyrodov, Mishetyan, and Petrakov. "16 July—25 Years From the Time of the Start"; Petrakov and Afanasyev. "Proton' Passion."

19 Previously named the State Aviation Plant No. 23, the plant was renamed the M. V. Khrunichev Machine Building Plant in July 1961 soon after the death of M. V. Khrunichev, the former Minister of Aviation Industry.

20. Telephone interview. Sergey Nikitich Khrushchev by the author, October 10, 1996

21. Anatoliy Kirpil and Olga Okara. "Designer of Space Planes Vladimir Chelomey Dreamed of Creating a Space Fleet of Rocket Planes" (English title), *Nezavisimaya gazeta*, July 5, 1994, p. 6. The authors state in the article, "In 1960 the government of the USSR decided to develop a rocket plane design at OKB-52."

... at the time [1960-61] a decision was taken that, in actuality, shifted the "firms" of S. P. Korolev and M. K. Yangel from primary to secondary roles. There appeared two projects which were given preference over all the others. According to the author of the idea [Chelomey], the first apparatus was planned for ensuring flight in near-Earth space [the Raketoplan], and the second, flight from planet to planet [the Kosmoplan]. Both apparatus were to be furnished with appropriately shaped wings, and each would *have* the capability to land at any assigned airport. I was astonished the author was undertaking to prepare the project in three years. Naturally, on the orders of Nikita Sergeyeuich Khrushchev, he was immediately allocated the means, and large projects in which major work had already been started were stripped [of their support]. In short, starting in 1961 our rocket-space industry began to be subsumed by confusion, which left us dearly stalled."

Funding for the research was coming from the Ministry of Defense, in particular the Soviet Air Force, which had watched two of its most promising spaceplane projects, from Tsybin and Myasishchev, canceled one after another." The Air Force was banking on the success of the effort, perhaps seeing in the program its means to counter the dominance of the Strategic Missile Forces. As with most military endeavors, dissension existed within the Air Force on the idea itself; some were more prone to ally themselves with Korolev's more traditional spacecraft designs, arguing that there was a greater chance of success, while others were reluctant to let go of winged conceptions and thus put their support with Chelomey.²⁴ At various points during the early 1960s, the Soviet Air Force issued "tactical-technical requirements," which were specifications for orbital vehicles to support Air Force objectives. For example, at a secret military conference in January 1962, the final recommendations included the development and creation of:

- An air-spaceplane with a flight altitude of sixty to 150 kilometers and an orbital spaceplane with an altitude of 1,000 to 3,000 kilometers
- A carrier-aircraft for launching "air-to-space" and "space-to-air" spacecraft and rockets"

Chelomey clearly catered his Raketoplan-Kosmoplan research to such proposals, although it is apparent that there was never a clear consensus on the issue at the time even within the Air Force. While winged reusable vehicles were preferable, senior military strategists also had to address the possibility that such vehicles would not be a reality in the near future.

There was an additional issue that factored into the military's intentions: the Soviet military closely followed the U.S. Air Force's X-20A Dyna-Soar spaceplane program. While some people considered Chelomey's Raketoplan research some sort of "raging fantasy," others in the General Staff could point out that the United States was conducting similar research. This is, in fact, what exactly happened on occasion. As the fate of the Dyna-Soar shifted up and down, the Ministry of Defense became less or more liberal with funding. According to some reports, funding for Chelomey's grand project periodically dwindled to zero as the wildly different news on U.S. hypersonic efforts filtered through to the General Staff in Moscow. One participant later

22 Nikolay Dombkovskiy "October — April — The Universe" (English title) *Sovetskaya rossiya* April 12 1989 p 3

23 Igor Afanasyev "Kosmoplan Chelomey's Project" (English title) *Krasnoye zvezda* August 26 1995 p 6

24 See N. P. Kamanin *Skrytyy kosmos kniga pervaya 1960-1963gg* (Moscow Infortekst F 1995) p 27 for a brief discussion over the Korolev versus Chelomey issue from the Air Force side

25 *Ibid* p 87

observed that "it created the impression that our work was directed not from Frunze Street, but rather from the Pentagon."²⁶

As indicated in the younger Khrushchev's observations about Chelomey, the goals of the Soviet program evolved and changed almost as fast as the designs of the vehicles themselves. By January–February 1961, the Kosmoplan theme encompassed automated and piloted missions to the Moon, Mars, and Venus, with the possibility of extended reconnaissance missions in low-Earth orbit. This last type of mission was probably its selling point to the Air Force. Through 1959–61, engineers had worked on numerous different designs of the Kosmoplan, but four of these offered the most promise:

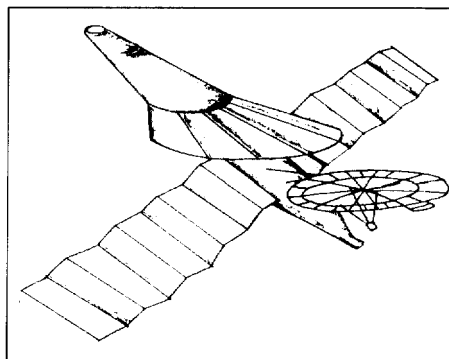

This is one conception of Vladimir Chelomey's idea of a robotic Kosmoplan to visit Mars. The design dates from the early 1960s (copyright Asif Siddiqi, based on a drawing by Igor Afanasyev)

- The automated AK-1-7 would be for flights to Mars or Venus. The spaceplane would be launched into orbit by a three-stage variant of Korolev's R-7 ICBM.
- The automated AK-1-300 would also be for flights to Mars or Venus. The A-300 booster, an early conception of a launcher developed at OKB-52, would launch this spaceplane.
- The automated AK-3-300 would be for both flights to the planets and missions in low-Earth orbit. Launch would be by the A-300 rocket.
- The piloted AK-4 spaceplane, studied in 1961, would be designed for carrying a single pilot into Earth orbit on the A-300 booster. The spaceplane would return from orbit in a special container, which would be discarded after atmospheric reentry at an altitude of twenty kilometers. The AK-4 would then glide 200 kilometers to a landing on an airstrip.²⁷

Despite heavy research on the ambitious program, by 1961, Chelomey's engineers were running into some major problems. Clearly, one of these obstacles was OKB-52's lack of experience in operating any space vehicles, let alone piloted ones. A step to creating a winged spaceplane for a flight to Mars proved to be a little too ambitious, given OKB-52's sole experience in developing a number of short-range naval cruise missiles. There were also purely technical issues, such as ensuring the reliability of the main spacecraft systems for such long-duration missions in conditions of vacuum, radiation, weightlessness, and so forth. One of the major problems was developing a nuclear power source, its proximity to the rest of the vehicle, and ensuring its return back to Earth.

Through 1961, OKB-52 prepared a predraft plan for the Kosmoplan project, which may have been examined by an *ad hoc* commission to assess its realistic prospects. Chelomey, apparently faced with the great technical and logistical difficulties of the effort, decided in 1961 to redirect the resources expended on the effort to more realistic proposals. These included the development of the "US" ocean reconnaissance satellite system, which would also use a nuclear power reactor during its missions in Earth's orbit. At the same time, Chelomey did not

²⁶ Sergey Khrushchev, *Nikita Khrushchev: krizisy i rakety vzglyad iznutri tom I* (Moscow: Novosti, 1994) p. 481.

²⁷ E-mail correspondence: Igor Afanasyev to the author, November 28, 1997. Rudenko, "Designer Chelomey's Rocket Planes," 48–49. Note that in the latter source, the AK-4 is referred to as the A-4.

completely abandon the Kosmoplan idea. Despite a significant reduction in work on this theme, engineers used the extensive research data base on the project, all on paper at that point, to explore various further options for piloted spacecraft to explore the Moon and Mars."

Like the Kosmoplan theme, work on the Raketoplan project also advanced swiftly in 1959-61. The program was originally conceived as a suborbital system for piloted missions, including anti-satellite missions, photo-reconnaissance, the identification of foreign satellites, and even bombing runs over the United States."

All the various models of the Raketoplan conceptualized by the end of 1961 had common features in design, and they were given the name "SR" (for Suborbital Rocket-Glider). There were only variations in specific design components, such as the presence or absence of jet engines for the returning first stage, the possibility of having folding wings for the second stage, or using a "flying wing" or canard-type configuration for both stages. Each particular design choice was closely tied to the stage arrangement of the Raketoplan—that is, either tandem or parallel—and thus affected the overall takeoff mass of the various conceptions. For example, one variant, the SR with a tandem arrangement of stages, had an engine unit for the first stage that allowed it to return back to the launch area.

In general, the Raketoplans had a launch mass of about 45 percent higher than the R-7 launch mass, the most powerful Soviet booster of the period. Based on early research, OKB-52 studied two major models of the Raketoplan, one for 8,000 kilometers range and the other for 40,000 kilometers. In dimensions and appearance, both models were relatively similar. The pilot sat in the central portion of the vehicle. The long-range version had three propellant tanks: a conical one with oxidizer at the forward end, a cylindrical one with fuel in the center, and another cylindrical one with oxidizer in the aft part of the fuselage. The short-range model had only two tanks: the conical one with oxidizer in the forward end of the spacecraft and a short cylinder with fuel in the aft end. Instead of the omitted third tank, the short-range spaceplane had a small passenger cabin for four to six seats. Engineers proposed that half-scale models of the Raketoplan could be launched on test flights to a range of 5,000 kilometers by Chief Designer Yangel's R-14 intermediate-range ballistic missile or to a range of 18,000 kilometers by Chelomey's own yet-to-be-developed UR-200 ICBM. Actual full-scale models of the spaceplane second stage could use two-stage variants of the R-7 for flights to 40,000 kilometers. These models would have folded wings for the initial ascent.

Given its ambitious nature, it is not surprising that Chelomey ran into serious problems with the Raketoplan program, too. Because the system combined elements of two different vehicles—an airplane and a rocket—it also inherited the weaknesses of both. The system as a whole was extremely complex and was very large, requiring the development of high-performance liquid-propellant rocket engines, new construction materials, and miniaturized electronics—technologies that posed great challenges for Soviet industry at the time. Like the Kosmoplan, the Raketoplan project also suffered from the limitations of OKB-52's experience in the field of developing missile-space systems

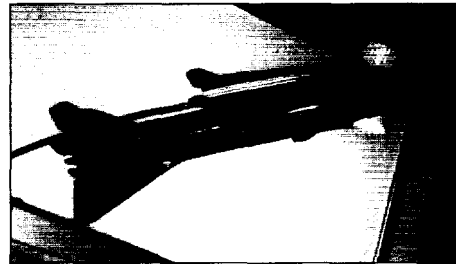

This is a model of Chelomey's air-launched piloted Raketoplan for suborbital and orbital missions for the Soviet Air Force. The model was displayed at an exhibition in the 1990s (copyright Steven Zaloga)

28 Afanasyev correspondence November 28 1997

29 Afanasyev "Kosrnoplan Chelomey's Project" Khrushchev Nikita Khrushchev tom 1 pp 480-81

An official decree of the Central Committee and the Council of Ministers, dated May 13, 1961, and titled "On the Revision of Plans for Space Objects Towards Accomplishment of Goals of a Defense Nature," had a direct effect on both the Raketoplan and Kosmoplan project. As a result of this governmental decision, preliminary work on both themes was terminated. The news was not all bad. Apparently, people in the government and Communist Party believed that the research carried out on the Raketoplan theme had great prospects for future work. The decree authorized OKB-52 to use the accumulated research work to proceed on a new piloted variant of the Raketoplan for military missions in Earth's orbit and deep space." For Chelomey's fortunes in general, this particular decree was perhaps one of the more important ones in his career. A leading designer from Korolev's OKB-1 later recalled:

In May 1961, just ten [sic] days prior to President Kennedy's speech on the U.S. commitment to go to the Moon, the Soviet government issued another decree on space matters. It actually reversed the previous decree of June 1960. Funds were taken from OKB-1 and transferred to the Chelomey design bureau. The same thing happened to subcontractors of OKB-1: they were ordered to shift their efforts to support Chelomey."

A significant amount of funding that had originally been allocated to Korolev was now shifted to Chelomey. The decree thus effectively killed the overtly far-reaching space program that Korolev proposed in the major June 1960 decree. Two factors played a role in this astonishing turnaround. The first was clearly Chelomey's continuing rise in prominence in the defense industry and his unmatched clout with Khrushchev. Second, there were the needs of the defense sector. While Korolev was pursuing projects that were predominantly for exploration, Chelomey's programs, especially the Raketoplan, catered to a Ministry of Defense increasingly uneasy about the possibility of war expanding to space.

In this climate, Chelomey continued to pursue work on the Kosmoplan project, despite an official order suspending such efforts. The amount of work on both the Kosmoplan and Raketoplan in 1960–64 was, in fact, unprecedented and compared very favorably with space-related work at the Korolev design bureau. OKB-52 engineers built mini-dimension ballistic models of their spaceplanes for aerodynamic testing in the wind tunnels at the Central Aerohydrodynamics Institute at Zhukovskiy, and they performed work on spacesuits for cosmonauts and catapults for rescuing cosmonauts during various phases of the mission. Other enterprises involved in the work included NII-1, NII-88, KB-1, NII-2, the M. M. Cromov Flight-Research Institute, the Institute of Aviation and Space Medicine, and the Central Institute of Aviation Motor Building." The pace of work was breathtaking. An engineer involved in the program later recalled, perhaps a little immodestly:

The most amazing thing was how we tore ahead, skipping even the initial drafts, immediately going on to the working plans stage, and even with such a speed how we nevertheless created heat shielding for the vehicle which even today has no analog in the world with respect to reliability and practical feasibility."

30. The decree is mentioned in Yu. P. Semenov, ed., *Raketno-Kosmicheskaya Korporatsiya "Energiya" imeni S. P. Koroleva* (Korolev. RKK Energiya, named after S. P. Korolev. 1996), p. 248.

31. Afanasyev correspondence, November 28, 1997.

32. Boris Arkadyevich Dorofeyev, "History of the Development of the NI-L3 Moon Program" (English title), presented at the 10th International Symposium on the History of Astronautics and Aeronautics, Moscow State University, Moscow, Russia, June 20–27, 1995.

33. Rudenko, "Designer Chelomey's Rocket Planes," 48–49.

34. Mikhail Rudenko, "Star Wars—History of the 'Death' of a Unique Spaceplane" (English title), *Trud*, August 26, 1993, p. 6.

All of this, of course, produced some tangible results. The work in late 1960 and early 1961 culminated in the creation of the first automated test bed called the MP-1 (the "MP" standing a little prematurely for "Maneuvering, Piloted"). Although engineers never finished a formal draft plan for the vehicle, the spacecraft was manufactured and ready for flight by late 1961.

The MP-1, developed primarily by the group of engineers transferred from the Lavochkin design bureau, was a small two-meter-length winged spacecraft with a mass of 1,750 kilograms. The vehicle had adjustable braking panels in the form of an umbrella mounted at the rear to ensure proper braking during reentry into the atmosphere. Engineers also installed graphite rudders on the vehicle for guidance, similar to those on outdated ballistic missiles. The test program for the vehicle included a single suborbital flight with ballistic maneuvering during descent. Maximum altitude would be 405 kilometers. The spacecraft would lift off and fly downrange 1,760 kilometers before entering the atmosphere at a velocity of 3,760 meters per second. After the maneuvering phase, the vehicle would land 1,880 kilometers downrange from the launch site. Recovery would be effected by a three-level system of drawing, braking, and primary parachutes working at altitudes of eight to four kilometers, thus reducing vertical downward velocity to about ten meters per second.³⁵ Because Chelomey did not have any boosters ready for launch at the time, he signed an agreement with Yangel to obtain an R-12 medium-range ballistic missile for the MP-1 test flight.

The day before the launch, set for December 27, 1961, the younger Khrushchev received his graduate degree, and there was a private dinner party given by Chelomey at a Moscow restaurant. Khrushchev recalls that everyone was quite a bit drunk by the time they got on the plane that night and headed out to the launch range to direct the flight.³⁶ Unlike all previous space-related launches, this one was to take place at the Air Defense Forces Test Range at Vladimirovka, just a few kilometers southeast of the Kapustin Yar site. Preparations proceeded without trouble the next morning amid heavy snowfall. The MP-1 was mounted on top of the R-12, and it was clearly visible as a spaceplane from a distance. The rocket lifted off successfully from the pad at site 1, and about forty minutes later, controllers received news that the vehicle had passed through the atmosphere and landed successfully by parachute.³⁷ The launch was kept secret for more than thirty years, but it was a landmark in the history of space exploration. It was the world's first hypersonic flight of a lifting body during which aerodynamic forces were used to control the atmospheric phase of reentry. When engineers inspected the spacecraft the following day, they were elated to discover that the heat shielding was almost completely undamaged; unexpected burning had been primarily limited to connection points between the ailerons and the wings.³⁸

The relative success of the MP-1 flight no doubt added to the engineers' confidence that they were on the right track in their work. By 1963, engineers at OKB-52 had completed the draft plan for the Raketoplan project, which contained the details of four variants of such a vehicle:

- A single-seat orbital anti-satellite spaceplane
- A single-seat orbital bomber of ground targets
- A seven-seat passenger ballistic spacecraft for intercontinental ranges
- A two-seat scientific spacecraft for circumlunar flight³⁹

35 Kirpil and Okara, "Designer of Space Planes": Mikhail Rudenko, "Designer Chelomey's Space Planes" (English title). *Vozdushniy transport* 51 (1995): 8-9; Khrushchev interview.

36 Khrushchev interview

37 Rudenko, "Star Wars"—History of the 'Death' of a Unique Spaceplane."

38 Khrushchev interview.

39. E-mail correspondence, Igor Afanasyev with the author. November 23, 1997

The first, second, and fourth vehicles would be launched by the UR-500 rocket, while the third would be launched by the UR-200. One of the more interesting elements of this modified Raketoplan theme was the piloted circumlunar mission. A number of Russian sources have suggested over the years that there was a firm state-level commitment to a piloted circumlunar project from as early as 1961.⁴⁰ Other reliable sources are vehement that there was no such commitment.⁴¹ It is more than likely, given the generally nonspecific nature of the entire Raketoplan-Kosmoplan effort, that the idea elicited only cursory interest from higher authorities, much like several of Korolev's piloted lunar plans of the period. Overwhelming evidence suggests that in the immediate years following Kennedy's speech, there were a litany of proposals from various chief and general designers to develop spacecraft to carry out piloted circumlunar flight, but that none of these prompted any serious consideration from Khrushchev, Kozlov, Ustinov, or Smirnov. Perhaps Chelomey grasped on the idea of circumlunar flight after hearing of similar proposals from the Korolev design bureau during the 1962-63 period. Little is known about Chelomey's 1963 vintage circumlunar spacecraft. It was one of the "scientific" versions of the Raketoplan and had a low lift-to-drag ratio. The vehicle was apparently a wingless spacecraft, capable of carrying one to two cosmonauts, that would carry out a ballistic reentry into Earth's atmosphere after flight around the Moon." Chelomey also continued work on the Kosmoplan theme at a low level from 1961 through 1964. Although the scope of the research remains unclear, it probably included work on a vehicle called "K" for automated flight to the Moon, Mars, and Venus, followed by a return to a regular airport on Earth.

Despite continuing problems, Chelomey's engineers obtained further data applicable to the Raketoplan-Kosmoplan theme from another active experiment in the early 1960s. In the framework of OKB-52's research on "aircraft warheads," the engineers developed a second hypersonic vehicle, the M-12, to test the technology for guided reentry into the atmosphere. Although the spacecraft was built specifically for the military warhead program, it served a dual purpose by continuing the research program begun by the first MP-1 spaceplane launched in 1961. The "conceptual design" of this vehicle was completed in October 1962, and the ensuing months were spent building a flight-test article at the design bureau's plant." The M-12 was similar in design to the MP-1, although the engineers finally dispensed with the umbrella-shaped braking panels and introduced new aerodynamic graphite rudders. The new vehicle was also equipped with on-board control systems far more complex than its predecessor.

The only launch of the M-12 model took place on March 21, 1963, from the same pad at site 1 at Vladimirovka where the MP-1 had lifted off. The launch on another of Yangel's R-12 missiles was successful at 1440 hours Moscow Time, and the engineers had to wait fifty minutes before they received news that the spacecraft had been destroyed upon reentry into the

40 See, for example, S. Colotyuk, "First People on the Moon (A Quarter of a Century Later)" (English title), *Novosti kosmonavtiki* 15 (July 16-29, 1994) 32-40, M. Chernyshov, "Why Were Soviet Cosmonauts Not on the Moon?" (English title), *Leninskoye znaniya*, August 1, 1990, p. 3; V. P. Mishin, "Why Didn't We Fly to the Moon?" (English title), *Znaniye tekhnike. seriya kosmonavtika. astronomiya* no 12 (December 1990) 3-43. In the last source, Mishin writes that in "1961 V. N. Chelomey's firm was assigned to work on a rocket-space system intended for circumlunar flight." One source hints that the circumlunar decision was a part of the major June 1960 space policy statement by the Soviet Communist Party and government. See Rudenko, "Designer Chelomey's Rocket Planes," 48-49.

41 Interview, Georgiy Stepanovich Vetrov by the author, January 9, 1997.

42 Interview, Cerbert Aleksandrovich Yefremov by the author, March 3, 1997. Note that one OKB-52 engineer, A. Petrov, recalled in 1995 that his diploma project in 1962 had been on a winged spacecraft for flight around the Moon and return to Earth. The lift-to-drag ratio was 10-3.0 "with suppression of overloads during reentry in the atmosphere up to 10." See Rudenko, "Designer Chelomey's Rocket Planes."

43 Yefremov interview.

atmosphere. The failure no doubt demoralized the design team, but they apparently received useful data via telemetry, which allowed them to make certain refinements to the spaceplane research and development process. The engineers later ascertained that the heat shield had not been sturdy enough to protect the vehicle because of a technical defect.⁴⁴

It seems that the Soviet Air Force, the chief sponsor of Chelomey's Raketoplan project, began to cool off on the effort by this time. This change of heart may have had much to do with the fate of the X-20A Dyna-Soar program in the United States. Prompted by a variety of reasons, principally Secretary of Defense Robert S. McNamara's belief that the spaceplane had no effective military use, the Johnson administration announced the termination of the project on December 10, 1963." The Soviets themselves may have also seen the potential political and public relations cost of pursuing a space-based system, one of whose goals was nuclear weapons delivery. There were other Soviet Air Force concerns, primarily the long lead-time expected for the operational capability of such a system. In January 1963, the Air Force sent a number of high-ranking representatives to visit OKB-52 to discuss the Raketoplan project. Commenting on reports on the project's progress, Lt. General Kamanin wrote:

*[f]or the present it's not even on paper, although we've been assured that the Draft Plan [will be ready] by February. Chelomey has already had a long two years to work on this theme, and in January 1961 when we were there with the Commander-in-Chief — then he made many promises — but nothing that was promised has been carried out. The real space ships in the future 3–5 years will be Korolev's ships, and only his — all the rest are unlikely to advance outside the bounds of experimentation.*⁴⁵

Ironically, two of Chelomey's automated space projects may have contributed to the lack of interest from the military. Both the "IS" anti-satellite and the "US" ocean reconnaissance programs were geared toward many of the same objectives slated for the Raketoplan. Undoubtedly, automated systems were much cheaper. The question of whether one was more optimal than the other was one that would not be adequately answered for many years, but given the strong inclination of senior military personnel to support robotic versus piloted military systems, the fortunes of the Raketoplan did not look too bright. Through the overwhelming obstacles, both technical and political, Chelomey continued to doggedly pursue his pet project, fielding even more advanced versions of single-seat military fighters in space.

Despite the setbacks, Chelomey was still at his peak at the time. If the June 1960 decree was meant to seal Korolev's preeminence as the leading space designer, the May 1961 decree effectively reversed that trend. In search of "revisions" to the original decree, the Soviet Communist Party and government stepped back from the original grandiose plans of a massive Soviet space program heading outwards into the solar system. The changed tenor of goals was now explicitly redirected to "goals of a defensive" nature — that is, anti-satellite weapons, reconnaissance satellites, and orbital bombers. And who better to pick to lead these programs than someone who had not only been doing work on these topics for some time, but a designer whose rising star was abetted and protected by the Soviet leader himself? Oddly enough, the revised decree was issued almost exactly a month after Gagarin's flight, a point in time one would suspect was the peak of power for Korolev. There were, however, simply too many forces

44. Rudenko, "Designer Chelomey's Space Planes". Yefremov interview; Kamanin, *Skrytiy kosmos*, p. 239, Afanasyev correspondence, November 23, 1997.

45. Roy F. Houchin II, "Why the Dyna-Soar X-20 Program Was Cancelled," *quest* 3 (Winter 1994) 35–37.

46. Kamanin, *Skrytiy kosmos*, p. 211.



This rare photo dating from the early 1970s shows Vladimir Chelomey with some of the leading scientists from the USSR Academy of Sciences. In the foreground left to right are TsNIIMash Deputy Director Vsevolod Audueuskiy, political scientist Piotr Fedoseev, General Designer Chelomey, and Academy President Anatoly Aleksandrou. In the immediate background, the two men facing each other are Korolev's successor Vasily Mishin and nuclear weapons scientist Yeugeny Velikhov (files of Peter Gorin).

working against Korolev and too few dramatic victories such as the Gagarin flight to compensate.

In 1963, the breadth of the projects at Chelomey's OKB-52 was staggering. The projects included three new ICBMs (UR-200, UR-500, and UR-100), two orbital bombardment systems (GR-1 and GR-2), two space launch vehicles (UR-200 and UR-500), a nationwide strategic defense system (Taran), an Earth-orbital spaceplane (Raketoplan), a lunar and interplanetary spaceplane (Kosmoplan), plans for an automated anti-satellite project (IS), and an automated naval reconnaissance program (US). This was in addition to his old work on as many as ten different naval cruise missiles.⁴⁷ All this was from an organization whose sole contribution to the defense industry by 1959 was a single short-range cruise missile. On April 29, 1962, he was elected a full Academician, joining the select ranks of Keldysh, Korolev, and Glushko. His influence in seemingly casual matters was also said to be without precedent. In a perhaps apocryphal story, a Soviet defector recalled years later that in the early 1960s, Chelomey wanted to build a dacha (a cottage) for his family in an area near Moscow where no buildings were allowed. He first appealed to the chairman of the Moscow Party Council to have the standard regulations waived in his case, but the chairman refused. Chelomey took the matter personally to Khrushchev. After hearing his story, the Soviet leader telephoned the chairman and told him, "I understand you have turned down comrade Chelomey's request. Aren't you forgetting you are an elected official?" Soon after, Chelomey was given his dacha.⁴⁸

⁴⁷ The naval cruise missiles included the early P-5 and P-5D models, the P-6 and P-35 (both approved on August 17, 1956), the P-70 Ametist (approved on April 1, 1959), the P-7 (approved on June 19, 1959), the P-35 Redut (approved on August 16, 1960), the P-25 (approved on August 26, 1960), and the P-120 Malakhit and P-500 Bazalt (both approved on February 28, 1963). All were anti-ship missiles, either launched from submarines or surface ships. See Shirokorad, "Rakety nad morem."

⁴⁸ Andrew Cockburn, *The Threat Inside the Soviet Military Machine* (New York: Vintage Books, 1984), p. 136.

It is easy and far too simplistic to attribute this immense growth of the Chelomey empire to the personal whims of Khrushchev. The Soviet leader was not deeply involved in much of the decision-making in the space program, weighing in only for the most important projects or for macro-level policy statements. He may not even have been partial to Chelomey simply because his son worked for the general designer. It is clear, however, that those under Khrushchev who were responsible for important decisions, well aware of the younger Khrushchev's location in the space industry, would only be too happy to favor Chelomey. Thus, it was probably never a case of direct gratuitous support as many historians have claimed. It was more likely a case of the upper ranks in the space program, such as Serbin, Ustinov, Smirnov, and Dementyev, making decisions that they believed would put them on the Soviet leader's good side.

In the two years since 1961, the entire climate of the Soviet space program had changed immensely as Kennedy's challenge began to finally infiltrate the stratum of the secret Soviet space program. The problem was no longer reaching the Moon, but reaching the Moon first. Having been mired for two years in various spaceplane projects, Chelomey, now certainly the most dominant designer in the Soviet space program, was not about lose out on this race. It was a race not only with the Americans, but, in a far more deleterious way, with his primary competitor and nemesis, Korolev.

Rocket Engines on the Frontier

The central goal of the comprehensive space plan issued by the government in June 1960 was the development of a series of heavy-lift launch vehicles—specifically the N1 and N2—to support a variety of future space projects. They were also to be OKB-1's means to maintain its preeminent position as the dominant Soviet space organization. The post-Sputnik euphoric climate—when OKB-1 Chief Designer Korolev was the toast of Party, military, and government leaders—was in its last breath. Despite the glowing successes of the Luna spacecraft and the flights of Gagarin and Titov, there was trouble on the horizon for Korolev's design bureau. The pressure was coming from all sides. Khrushchev had found in Yangel and Chelomey better alternatives to the strong-headed Korolev. Both Yangel and Chelomey were more interested in gearing their products toward military needs than some abstract youthful dream. Chelomey had ascended literally from nowhere, threatening to run over any in his path. The military continued to have problems with Korolev over his pathological insistence on using cryogenic propellants over storable ones. Finally, Korolev had broken ranks with his closest collaborator, Glushko, over a variety of technical issues related to engine design.

As astonishing as it seems, mid-1961, right after Gagarin's flight, was a time of great uncertainty for Korolev. In a revealing episode from the period, Korolev clearly let the stress show through. In late July 1961, Korolev met secretly with another beleaguered Chief Designer, Grigoriy V. Kisunko of the KB-1 design bureau, which was responsible for designing the Soviet Union's first anti-ballistic missile system, to discuss the "attack" from Chelomey. Kisunko later recalled Korolev's words vividly: "This is the second time they have tried to cross me out of life."⁴⁹ The two designers discussed writing a letter to other individuals in the Central Committee about Khrushchev's favoritism, but they decided to abandon the idea, perhaps so as not to risk their own careers. In this climate, the N1 and N2 boosters were not simply the "next" of Korolev's projects, but his lifeline to maintaining singular domination of the space program. Most of his grand plans from the June 1960 decree—the development of large piloted space stations, piloted lunar space vehicles, and interplanetary ships—all rested on the fate

49 Mikhail Rebrov "Project Taran" (English title) *Krasnaya zvezda* June 18 1994 p. 6

of these boosters. They assumed an increasingly symbolic and mythological proportion in his life, becoming literally "the last love of his life" as some of his biographers have claimed.

The June 1960 decree specified that the draft plan for the first vehicle, the N1, would be completed by the end of 1962. With this date in mind, OKB-1 issued a formal "technical assignment" on October 1, 1960, to four rocket engine design bureaus for the development of very high-performance engines. All the engines would be closed cycle with high-pressure combustion chambers, high specific impulses, and relatively small mass. The subcontracting organizations were Glushko's OKB-456 at Khimki, Isayev's OKB-2 at Kaliningrad, Kosberg's OKB-154 at Voronezh, and Kuznetsov's OKB-276 at Kuybyshev."

While Glushko, Isayev, and Kosberg had been involved in rocket engine design for ballistic missiles, it would be a relatively new field of work for Kuznetsov. He had become involved in the missile business in the late 1950s during the open conflict between Korolev and Glushko over the R-9 ICBM. When Kuznetsov's engines were eventually rejected for a variant of the R-9, under pressure from OKB-1 First Deputy Chief Designer Mishin, Korolev invited him to work on the N series boosters. The invitation was clearly related to Kuznetsov's preference for working with Korolev and Mishin's favored cryogenic combinations as opposed to Glushko's storable. Kuznetsov's OKB-276 was also located very close to OKB-1's subsidiary manufacturing plant, the Progress Machine Building Plant in Kuybyshev. Despite Korolev's somewhat desperate act of inviting Kuznetsov to participate, Glushko was clearly far ahead of the game; he was already in the midst of developing a powerful series of new engines for Yangel's ICBMs with storable propellants. Kuznetsov, on the other hand, would have to start from scratch.⁵¹

At some point soon after, it seems that Kosberg's OKB-154 dropped out from the running because of commitments to Chelomey's projects, to be replaced by another aviation engine design organization, OKB-165." Headed by fifty-two-year-old General Designer Arkhip M. Lyulka, the design bureau, established in March 1946, had primarily designed turbojet engines for a variety of Soviet military and civilian aircraft, remaining outside the mainstream of the missile and space programs." Thus the four remaining designers—two from the aviation industry (Kuznetsov and Lyulka) and two from the armaments industry (Glushko and Isayev)—signed an amended technical assignment document on March 1, 1961.⁵⁴ Somewhat comparable to the Western concept of a request for proposals, the technical assignment included specific recommendations for particular areas for each designer on which to focus in creating the N1 and N2 boosters. Glushko and Kuznetsov were assigned to develop engines for the first three stages, while Lyulka and Isayev would focus on high-energy upper stages, as follows:

50 Igor Afanasyev "N1: Absolutely Secret" (English title), *Krylya rodiny* no. 9 (September 1993) 13-16.

51 B. Ye. Chertok, *Rakety i lyudi. Filii Podlipki Tyuratam* (Moscow, Mashinostroyeniye, 1996), pp. 345-46.

52. Note that although Kosberg did not sign the adjusted technical assignment document, his design bureau did produce a powerful 150-ton-thrust engine, the 8D415K, in support of the N1 program. The propellants were liquid oxygen and kerosene. See Varfolomeyev, "Readers Letters On Rocket Engines."

53 Lt. Col. S. Vachayev, "From the Origins of the Reactive Era" (English title), *Aviatsiya i kosmonautika* no. 3 (March 1988), 31-32, S. P. Kuvshinnikov, "23 March—75 Years From the Birth of A. M. Lyulka (1908)" (English title), *Iz istorii aviatsii i kosmonavtiki* 48 (1984) 87-95. Lyulka did, however, cooperate with Kuznetsov during the development of the NK-9 rocket engine for the abandoned R-9M missile in 1958-59.

54 G. Vetrov, "The Difficult Fate of the N1 Part II" (English title), *Nauka i zhizn* no. 5 (May 1994): 20-28; Afanasyev, "N1 Absolutely Secret."

Propellant Designer	Combination	Thrust	Stage on the NI
Glushko	LOX-UDMH	150 tons	Stage I
Glushko	N ₂ O ₄ -UDMH	150 tons	Stage I
Glushko	LOX-UDMH	180 tons	Stage II
Glushko	N ₂ O ₄ -UDMH	150 tons	Stage II
Glushko	Fluorine, etc.	20-25 tons	Stage III
Kuznetsov	LOX-kerosene	150 tons	Stage I
Kuznetsov	LOX-kerosene	45 tons	Stage II
Kuznetsov	LOX-kerosene	45 tons	Stage III
Lyulka	LOX-LH,	40 tons	Stage II
Lyulka	LOX-LH,	40 tons	Stage III
Isayev	LOX-kerosene	Not available	Stage II
Isayev	LOX-LH,	7.5 tons	Stage III ⁵⁵

Key. LOX = liquid oxygen; UDMH = unsymmetrical dimethyl hydrazine; N₂O₄ = nitrogen tetroxide; and LH, = liquid hydrogen.

The rationale behind Glushko's selection was obvious: his propellants were all geared toward dual use on military ICBMs as well as space launch vehicles, a strategy that makes perfect sense given the economic exigencies of the day. Of the four first- and second-stage engines, the favored ones for the NI boosters would be the two nitrogen tetroxide (N₂O₄)-UDMH engines, known as the RD-253 and RD-254, respectively. These were the first closed-cycle rocket engines developed by Glushko.⁵⁶ By the early 1960s, Glushko had all but abandoned liquid oxygen (LOX) because of problems associated with high-frequency oscillations, and the two proposals for LOX-based engines for the NI/N2 program seems to have been his last stab at LOX before focusing fully on storable propellants. The fluorine-based engine was more of a curiosity than anything else. Theoretically, fluorine-type rocket engines would offer high specific impulses, but this remained to be proved in test conditions.

The origins of Kuznetsov's engines were far more interesting. OKB-276's first foray into the development of high-thrust liquid-propellant rocket engines had been developing the NK-9 engine for the first stage of an abandoned variant of Korolev's R-9 ICBM, named the R-9M. The organization's extensive experience in designing aircraft engines was little use in this project, and to hasten development, there was significant cooperation with the rocket engine department at OKB-1. Foreseeing a possibly difficult time in engine development, Korolev allowed Kuznetsov's engineers to have full access to propulsion research data on one of OKB-1's new upper stage engines.⁵⁷ The R-9M missile was eventually never built because of severe pressure from Glushko, and Kuznetsov simply decided to use the same engine as a basis

⁵⁵ *Ibid* Semenov ed. *Raketno Kosmicheskaya Korporatsiya* p 262

⁵⁶ The less well known RD 254 is mentioned by journalist A Bolotin in M Rudenko "The Moon Slips Away" (English title) *Ekonomika i zhizn* 48 (November 1991) 19

⁵⁷ Korolev's engine was the Si 5400 and it served as the fourth stage engine for the 8K78 (or Molniya) booster used to launch the early Mars and Venus interplanetary spacecraft. See Semenov ed. *Raketno-Kosmicheskaya Korporatsiya* p 123

to design ones for the N1 and N2. The forty-ton single-chamber NK-9 would serve as the foundation for different directions of development. First, Kuznetsov's engineers would scale up its performance characteristics to produce an engine with a 150-ton thrust; second, they would produce high-altitude variants of the engine for use on the N1's second and third stages. To shorten development periods, all three engines would retain basic design elements of Korolev's upper stage engine.

High-energy engines for the upper stages—in particular those using liquid hydrogen (LH₂) and LOX—were assigned for development to Lyulka and Isayev. In 1961, manufacturing of LH₂ for rocketry purposes in the Soviet Union was almost nonexistent. Neither the technology nor the resources were available. It was well-known among most space enthusiasts, as far back as Tsiolkovskiy, that of all the chemical sources of propellants, the LH₂-LOX combination was the most efficient; specific impulses were significantly higher with LH₂ than with either Glushko's storable components or the R-7's LOX-kerosene pairing. Unfortunately, LH₂ was also extremely difficult to manufacture, maintain, and use as propellant. The boiling temperature of LH₂ is -252.6 degrees Centigrade, necessitating refrigeration techniques well beyond the means of Soviet industry at the time. Despite these difficulties, the same belief in its performance led the Advanced Research Projects Agency in the U.S. Department of Defense to issue a contract for the development of a LH₂-LOX engine in late 1958. This engine, which became part of the Centaur upper stage, was flown as early as May 1962.⁵⁸

Korolev was without doubt the primary instigator for a similar effort in the Soviet Union. One would have expected Glushko to support these efforts, but his historic dislike of cryogenic propellants veered him away from committing to the design of a high-energy LH₂ stage. Glushko's opponents in fact like to quote one of his more infamous exhortations, authored in 1935, when as a twenty-seven-year-old engineer he had written: "liquid oxygen is far from the best oxidizing agent, while liquid hydrogen will never be of any practical use in rocket equipment."⁵⁹ Korolev, with a much more solid faith in the capabilities of LH₂, fired off a letter to the government on April 8, 1960, in which he argued:

OKB-1 considers it extremely necessary to develop on a wide front of work the creation of an *industrial* base for the creation of liquid hydrogen, for work on methods of its storage and transportation and also the study of its characteristics and the operational *characteristics* of hydrogen, and preparation of recommendations for the design of special aggregates and fixtures for working with *hydrogen*.⁶⁰

A draft plan on the use of LH₂, "On the Possible Characteristics of Space Rockets Using Hydrogen," dated September 9, 1960, was also addressed to Keldysh, Glushko, Lyulka, and Academician Anatoliiy P. Aleksandrov, the erstwhile Director of the Academy's Institute of Atomic Energy.⁶¹ Resistance from Glushko may have played a significant part in downplaying the need for such work. Although preliminary work on LH₂ engines began at the Isayev and Lyulka design bureaus in 1960, these efforts had very little funding. In addition, the military, for

58 Linda Neuman Ezell NASA *Historical Data Book Volume II Programs and Projects 1958-1968* (Washington DC NASA Special Publication (SP) 4012 1988) p 44 The May 1962 launch was a failure The second launch in November 1963 was successful

59 A Tarasov "Missions in Dreams and Reality' (English title) *Prauda* October 20 1989 p 4 The quote is from Glushko's monograph *Khimicheskiye istochniki energii* (*Chemical Sources of Energy*) which was published in 1935 while he was working at the RNII

60 G Vetrov 'The Difficult Fate of the N1 Part I' (English title) *Nauka i zhizn* no 4 (April 1994) 78-80

61 *Ibid* Semenov ed *Raketno Kosmicheskaya Korporatsiya* p 248

obvious reasons, had little interest in them. It was a strategic mistake that cost the Soviet space program much in terms of capability and efficiency, but Korolev alone did not have the force to single-handedly create a new industry in the Soviet Union. Initial versions of the N1 and N2 rockets would have to rely on less efficient combinations

Another area of advanced research was nuclear engines—a pipe-dream of sorts that had been bandied about by different designers through the postwar years. Nuclear energy, of course, could theoretically provide even higher specific impulses than LH₂. While the best LH₂-LOX rocket engines could be expected to have specific impulses in the range of 400 to 450 seconds, nuclear engines could potentially have values as high as 800 to 1,000 seconds (with solid fuel) or even 2,000 to 5,000 seconds (with uranium compound plasmas).⁶⁵ Even prior to the launch of the first Sputnik, in 1955 and 1956, the advanced projects NII-1 research institute, headed by the ubiquitous Keldysh, had initiated preliminary plans for nuclear propulsion development. Government intervention on the matter occurred on June 30, 1958, with the issuing of a top-level decree requesting a draft plan on a nuclear engine.⁶⁶ Such a preliminary document was prepared and approved by Korolev on December 30, 1959. By 1960, at least six design bureaus and four scientific-research institutes were involved in the effort.⁶⁷ As with numerous other advanced technology programs, the United States and the Soviet Union engaged in research almost simultaneously. After discussions dating back to the mid-1940s, the U.S. Department of Defense and the Atomic Energy Commission began such research efforts as Kiwi and NERVA at the same time.⁶⁸

Applications for the use of nuclear engines were also studied vigorously at the time. In 1959 and 1960, the OKB-1 proposed three new rockets—two space launch vehicles and an ICBM—that would use nuclear engines in some capacity. Engines would be provided by Glushko's OKB-456 and another design bureau, the OKB-670 headed by Chief Designer Mark M. Bondaryuk, a specialist in the development of ramjet engines. Bondaryuk had previously developed the engines for the abandoned Burya and Buran intercontinental cruise missiles in the 1950s. One of the space launch vehicles proposed, the YaKhr-2, had an unusual configuration: it looked just like the standard R-7 except it had six instead of four strap-ons. The core itself would be equipped with the nuclear engine. The other launcher tabled was a "super-rocket" with a lifting capacity of 150 tons to Earth orbit and a launch mass of 2,000 tons. The second stage would use a powerful nuclear engine.⁶⁹ None of these proposals were pursued with any seriousness after late 1960 as a result of intensive research, which proved that for immediate purposes, chemical sources of propulsion would be more fruitful. Many of the design bureaus in the nuclear program also lost interest. It would be the mid-1960s before both nuclear and LH₂ engines received sufficient support to commence dedicated projects to develop such engines.

62 Joseph R. Wetch, Alexey Ya. Goldin, Anatoly A. Koroteev, Alexander D. Konopatov, Vladimir A. Pavshook, Nikolai N. Ponomarev, Stepanov Vitaly F. Semyonov and Ivan Fedik, "Development of Nuclear Rocket Engines in the USSR," AIAA/NASA/OAI Conference on Advanced SEI Technologies, AIAA 91-3648, September 4-6, 1991. A. Koroteyev, "From the History of Space Science: The Scientific Research Institute of Jet Propulsion" (English title) *Aviatsiya i kosmonautika* no. 6 (November-December 1993) 39-41.

63 The title of the decree was "On the Creation of Missiles with Engines on the Basis of Using Nuclear Energy." See Semenov, ed., *Raketno Kosmicheskaya Korporatsiya*, p. 248. Leonid Kvasnikov, Anatoliy Kostylev, and Vladimir Maksimovskiy, "Nuclear Rocket Engines" (English title) *Vestnik vozdushnyy flota* no. 6 (June 1996) 53-55. A high level meeting in February 1959 purportedly about nuclear propulsion research is described in Aleksandr Romanov Korolev (Moscow: Molodaya gvardiya, 1996) pp. 323-26.

64 The design bureaus were OKB-1 (S. P. Korolev), OKB-165 (A. M. Lyulka), OKB-301 (S. A. Lavochkin), OKB-23 (V. M. Myasishchev), OKB-670 (M. M. Bondaryuk), and OKB-456 (V. P. Glushko). The institutes were NII-1 (M. V. Keldysh), the P. I. Baranov Central Institute of Aviation Motor Building or TsIAM, the I. V. Kurchatov Institute of Atomic Energy (A. P. Aleksandrov), and VNII-16. See Kvasnikov, Kostylev, and Maksimovskiy, "Nuclear Rocket Engines."

65 Ezell, NASA *Historical Data Book*, Volume II, pp. 482-83.

66 Semenov, ed., *Raketno Kosmicheskaya Korporatsiya*, p. 248.

CHALLENGE TO APOLLO

Korolev Versus Glushko: No Compromise

In January 1961, a large meeting of chief designers, senior military officers, and defense industry representatives took place at Tyura-Tam, ostensibly to discuss the future of heavy-lift boosters in the Soviet Union. Glushko, as one of the leading chief designers in the space program, served as the *ad hoc* chairman of this meeting. The proceedings for the most part went remarkably smooth, with agreement on the principal design of the N1 and N2, both of which would dispense with the old "cluster" design of the R-7 and instead use the structurally simpler "tandem" design.⁶⁷

Progress on the N series of boosters was dramatically affected by the May 1961 government decree that effectively gave Chelomey a dominant role in the space program. As recalled by a senior OKB-1 engineer, "government authorization of the N1 development was downsized to further paper studies."⁶⁸ A number of subcontractors for the N1, including Kosberg's design bureau, were ordered to redirect their efforts toward Chelomey's projects. Whereas in the earlier government order from 1960 the dates for completion of the project were 1960-63 (for the N1) and 1963-67 (for the N2), the new decree pushed the timetable back further to 1962-65 (for the N1) and 1963-70 (for the N2).⁶⁹

The delays and uncertainties in the program no doubt negatively affected the Korolev-Glushko relationship over the issue of propellants. In July 1961, two weeks before Titov's day-long Vostok 2 mission, Korolev paid a personal visit to Glushko's design bureau at Khimki, intent on trying to convince the engine designer to consider the possibility of using cryogenic propellants. The conversation began calmly but quickly escalated into an accusative tone. Glushko, standing his ground with toxic storable propellants, called Korolev's ideas about designing the N1 akin to "dilettantism."⁷⁰ He reminded Korolev of the infamous failure of the 120-ton cryogenic engine for the R-3 program in the early 1950s, which had delayed the entire Soviet rocketry program. The problems with high-frequency oscillations in that LOX-kerosene engine had been simply too much to overcome. For his part, Korolev reminded Glushko of the 1960 disaster involving the R-16 ICBM, a rocket that used toxic self-igniting propellants. The meeting ended without resolution, as rational arguments began to be increasingly couched in terms of personal attacks. It was symptomatic of many more meetings to come."

The propellant issue came to a head in December 1961, when Glushko decided to take action. In an official letter to Korolev, he demanded that the N1 be redesigned to be equipped with storable propellants, with N₂O₄ instead of LOX. As one Soviet space historian recalled, it

67. Georgiy Stepanovich Vetrov, "Development of Heavy Launch Vehicles in the USSR," presented at the 10th International Symposium on the History of Astronautics and Aeronautics. A serious conflict occurred only when Glushko abruptly informed Korolev that contrary to their earlier agreed-on technical assignment, he would develop engines of 100 tons thrust instead of 150 tons. Calling this a violation of their earlier agreement, Korolev argued that this was unacceptable because lower thrust engines would require a higher number of engines. The matter was eventually left unresolved, as was the final choice of propellants for the boosters, which was a far more thorny issue between the two designers.

68. Dorofeyev, "History of the Development of the N1-L3 Moon Program."

69. Mishin, "Why Didn't We Fly to the Moon?"; Semenov, ed., *Raketno-Kosmicheskaya Korporatsiya*, p. 248.

70. Romanov, Korolev, pp. 425-27.

71. As early as 1960, Korolev had begun to attack what he considered Glushko's monopoly in the creation of high-thrust liquid-propellant rocket engines in the Soviet Union. In a letter dated July 4, 1960, written to Commander-in-Chief of the Strategic Missile Forces Marshal M. I. Nedelin, Korolev wrote that "OKB-1 has reason to believe that there is a lag arising . . . there are too few OKBs at the present time which are engaged in work on rocket engines." See Vetrov, "The Difficult Fate of the N1 Part I," p. 80.

was "a sort of ultimatum." Glushko claimed that he had "special authority" to make such a demand, apparently at the behest of Khrushchev himself. In retrospect, the timing of the letter goes a long way to explain Glushko's apparent "ultimatum." In November 1961, a month before this letter, he had more or less committed to building the 150-ton storable propellant engines for Chelomey's new UR-500 booster. If he agreed to Korolev's demands on the N1 engines, he would now have to design yet another similar 150-ton engine, only with LOX-kerosene—an effort that he reasonably considered a duplication and a waste of time. Combined with his earlier problems with LOX and the military's fondness for storable propellants, from Glushko's point of view, there was simply no other rational choice: he would stick with his RD-253 and RD-254 engines and propose them for the N1 and N2 boosters. Glushko's letter served to bring the debate to a standstill. Within days, the Soviet government established a commission, headed by Academy of Sciences President Keldysh, to specifically



There are almost no photos of Korolev and Glushko together. This is an extremely rare shot of the two giants of the Soviet space program dating from around 1959 and taken at Tyura Tam (files of Peter Gorin)

look into the matter and make a formal recommendation on the propellant issue. The commission meetings started out as acrimoniously as one would expect. Perhaps sensing that Keldysh would side with Korolev, Glushko, for the first time, openly quarreled with Keldysh. Glushko had reason to be defensive: by January 1962, after a visit to the Kuznetsov engine design bureau in Kuybyshev, it was becoming clear that the commission was indeed favoring Korolev.

The matter was finally taken to the "ministry" level with a series of intensive meetings between February 10 and 21, 1962, at the premises of the State Committee for Defense Technology in the Kremlin. Presiding was the State Committee Chairman Smirnov, who having been appointed to the position only nine months earlier was having to face a battle of gargantuan proportions. Apart from purely technical issues, it was clear that both Korolev and Glushko needed each other to move ahead on the N series boosters. If anything, Korolev needed Glushko far more than the reverse. It would be a significant risk for Korolev to build the centerpiece of the future Soviet space program without the help of the most successful engine builder in the Soviet Union. On the other hand, Glushko could possibly do without Korolev's N1; he had, after all, sided with Chelomey on his new UR-500 booster, and given Chelomey's continuing rise to power, he could continue to ride on his coattails. The meetings at Smirnov's proved to be the breaking point for the conflict. On one particular occasion, the discussions degenerated into a shouting match of insults and personal attacks between the two. Korolev was insistent that storable propellants were far too toxic and explosive. When Korolev began talking about "powder kegs," Glushko shot back, "Oh, I understand, you'd ideally like a steam engine! . . . So you want to fly in space but remain Mr. Clean?!" Glushko began to invoke "state interests"—that is, the military's preference for storables—but Korolev would not hear

72 Vetrov. "Development of Heavy Launch Vehicles in the USSR."

73 Yaroslav Golovanov, *Korolev: fakty i mify* (Moscow: Nauka, 1994) p. 712

it. Yelling by this time. Korolev cut him off: "Listen, if you don't want to, then don't do it! We'll get by without you!" Dead silence followed as even Smirnov refrained from saying anything. The deputies of both Korolev and Glushko quietly left the room, letting the two old men deal with each other's demons.

The Propellant Commission, after these meetings, recommended the following pairs of propellant for the N boosters, in order of their preference: LOX-kerosene. LOX-UDMH. and nitric acid-UDMH. For obvious reasons. Glushko was not happy with the decision, and as the intransigence of both designers came to the fore. "a number of high-ranking officials" found themselves trying to mediate the discord." Buoyed by the commission's decision and unwilling to compromise with Glushko, Korolev immediately began resorting to his contingency plans—that is, put his lot with the inexperienced Kuznetsov design bureau. Of the four engine designers contracted in the initial technical assignment, only Kuznetsov and Glushko had agreed to design the first- and second-stage engines. With Glushko out, there was simply no other choice. Despite the commission's decision, the future of his boosters was not guaranteed. Korolev had a number of major opponents in powerful positions to overcome before the N booster project was allowed to continue. His new R-9 ICBM had been performing poorly since test flights began in April 1961: this had deleterious effect on OKB-1's relationship with important individuals in both the Communist Party and the military. The ascendance of Frol R. Kozlov as the Party leader of the space program was also a big stumbling block to Korolev's plans; Kozlov had consistently sided against Korolev at important junctures and may have been responsible for the May 1961 decree favoring Chelomey. Given that Kozlov was the most important decision-maker in the Soviet space program, the N program's fate depended to a great extent on Kozlov's assessment of the situation.

In early 1962, immediately after the commission's recommendations, there was a major design change in the conception of the N1 and N2 boosters. Korolev's engineers scrapped the original N1 proposal (forty to fifty tons to low-Earth orbit) and renamed the more powerful N2 proposal (fifty to eighty tons to low-Earth orbit) the "new" N1 launch vehicle. The nominal payload capability was set at seventy-five tons, sufficient to allow the accomplishment of a variety of long-term goals, including military missions and a piloted mission to Mars (the latter being one of the more favored future plans at OKB-1 at the time).⁷⁴ It was clear to Korolev that a direct jump from the modest Vostok booster (about six tons) directly to the N1 (seventy-five tons) would be a tremendous leap and a significant risk. Before receiving further funding and support to continue the project, he would not only have to justify the effort in terms of the needs of the defense industry, but he would also have to provide some kind of guarantees to the various reviewing scientific-technical councils that a leap from six tons to seventy-five tons would be feasible given the current state of Soviet rocket technology. Any argument in support of Korolev's position would no doubt also suffer from the fact that Glushko was no longer a willing participant in the endeavor.

To ease the jump in payload capabilities, Korolev hatched a brilliant strategy. In 1961, when discussions on orbital weapons systems had first been discussed at high-level government meetings, OKB-1 had also begun studying a similar project. Designated the Global Missile No. 1 (GR-1), the rocket would launch a 2.2-megaton warhead into a 150-kilometer orbit around

74 *Ibid*

75 Vetrov. "The Difficult Fate of the N1 Part II "

76 See Semenov, ed *Raketno Kosmicheskaya Korporatsiya*, p. 249 where it states "Computations proved the majority of goals of military and space nature could be solved by a [rocket carrier] with a payload mass of 70-100 tons put into a circular orbit around the Earth at an altitude of 300 km " This mass analysis may have been undertaken in cooperation with the military, in particular the research and development Institute of the Strategic Missile Forces NII 4

Earth. In case of hostilities, the warhead container would deorbit, reenter, and hit the "designated target." In one sense, Korolev's GR-I proposal was meant to appease an increasingly restless military, who were disappointed with the erratic performance of the trouble-prone R-9. On the other hand, the missile would also serve as a perfect test bed for NI engine technology. The engine for the first stage of the GR-I, the NK-9, was the same one used for the abandoned R-9M ICBM. The GR-I's second stage would simply use a variant of the NK-9, named the NK-9V, whose only difference was that it was modified for altitude use. Both these engines were prototypes for engines for the first three stages of the giant NI. Finally, the third stage of GR-I would be equipped with the 8D726 engine, yet another prototype for an upper stage engine for the NI.⁷⁸ All the stages would use Korolev's favored LOX-kerosene combination. As a proposal, it was perfect in all respects. The GR-I would fly dozens of test missions proving out important aspects of NI architecture: by the time that the NI would come on line in the mid-1960s, all of its primary propulsion components would be tested and ready. The only hurdle was the approval to undertake both projects."

in early February 1962. Korolev received an invitation from Khrushchev to attend a meeting of the top-secret Council of Defense at the holiday resort of Pitsunda. The entire high command of the Soviet defense industry, Communist Party, armed forces, and design bureaus were to attend." It would not be an overstatement to suggest that it was perhaps the single most important policy meeting in the early Soviet space program, as the three main space designers—Korolev, Chelomey, and Yangel—vied for a slice of the cosmos. To Korolev, it was clear that this would perhaps be his last opportunity to save the NI project. An endorsement from Khrushchev himself would remove a number of problematic obstacles, in particular the less-than-enthusiastic Kozlov. Each of the three designers arrived at Pitsunda in late February armed with beautifully illustrated posters of their respective proposals and projects, intent on coercing the minds of the most powerful in the Soviet state. The first day of the meeting, February 22, was dedicated to briefings by several naval commanders, ending with a presentation by Chelomey. His performance was flawless. By the end, he had earned the green light to proceed with a new version of the UR-200 ICBM, as well as a completely new all-purpose ICBM/space launch vehicle/orbital bombardment system, the famous UR-500. Because of time limitations, Korolev's speech was delayed to the second day

77 *Ibid* pp 128-30

78 *Ibid* pp 129-252 Peter A. Gorin "The Dark Side of the Moon Race" presented at the annual meeting of the American Association for the Advancement of Slavic Studies Boston, MA, November 14-17, 1996

79 Korolev had already apprised the Soviet leadership of the GR-I proposal. In September 1961, he sent a letter on the issue to the government, and in November, one to Khrushchev himself. The latter was signed by S. P. Korolev, N. D. Kuznetsov, N. A. Pilyugin, M. S. Ryazanskiy, and V. P. Mishin, implying that at least three of the 'big six' chief designers—Korolev, Pilyugin, and Ryazanskiy—were supportive of the idea.

80 Among those known to have been present at the meeting were N. S. Khrushchev (First Secretary of the Central Committee), F. R. Kozlov (Secretary of the Central Committee for Defense Industries and Space), I. D. Serbin (Chief of the Defense Industries Department of the Central Committee), A. N. Kosygin (First Deputy Chairman of the Council of Ministers), A. I. Mikoyan (First Deputy Chairman of the Council of Ministers), R. Ya. Malinovskiy (Minister of Defense), A. A. Crechko (First Deputy Minister of Defense), M. V. Zakharov (Chief of the General Staff of the Ministry of Defense), S. S. Biryuzov (Commander in Chief of Air Defense Forces), S. G. Gorshkov (Commander in Chief of the Navy), K. S. Moskalenko (Commander in Chief of the Strategic Missile Forces), S. P. Ivanov (Secretary of the Council of Defense), D. F. Ustinov (Chairman of the Military Industrial Commission), L. V. Smirnov (Chairman of the State Committee for Defense Technology), P. V. Dementyev (Chairman of the State Committee for Aviation Technology), B. Ye. Butoma (Chairman of the State Committee for Ship Building), Ye. P. Slavskiy (Minister of Medium Machine Building), M. V. Keldysh (President of the Academy of Sciences), S. P. Korolev (OKB-1 Chief Designer), V. P. Glushko (OKB-456 Chief Designer), V. N. Chelomey (OKB-52 General Designer), M. K. Yangel (OKB-586 Chief Designer), V. P. Makeyev (SKB-385 Chief Designer), N. A. Pilyugin (NII-885 Chief Designer), V. I. Kuznetsov (NII-944 Chief Designer), and S. N. Khrushchev (OKB-52 Deputy Department Chief).

CHALLENGE TO APOLLO

In contrast to the smooth and sophisticated Chelomey, Korolev spoke in concise, choppy phrases. He showed his posters of the NI to the assemblage, briefly reviewing the work done since the June 1960 decree. Emphasizing the delays and problems with funding, he casually brought up the need to raise the payload capability of the vehicle from its current forty tons to seventy-five tons. Calculations had showed that forty tons would be simply insufficient for missions to the Moon and the other planets. Two variants were conceptualized at that point: one with twenty-four 150-ton-thrust engines and one with a smaller number of 600-ton engines. All the engines would use LOX and kerosene, with the upper stages using LH₂. Korolev apparently startled Khrushchev by saying that all these engines would be designed not by Glushko but by a new entrant to the space program, Kuznetsov. When asked why Glushko was not participating, Korolev was forthright, saying Glushko had refused to work on the engines and that he was also burdened by orders from Yangel and Chelomey. Amazingly, Glushko and Korolev began to argue vociferously in front of the distinguished assemblage, threatening to derail any notion of rationality. Khrushchev, silent all this time, cut them off, and instructed Ustinov to carefully assess Korolev's modified proposals and prepare recommendations." Korolev's proposal on the GR-I was brushed away, mainly at the behest of Central Committee Secretary Kozlov, who had been opposed to the idea all along. The continuing problems with Korolev's R-9 ICBM had put a wedge in the relationship between his design bureau and the Central Committee.

Yangel spoke after Korolev and put a new twist on the entire situation. Yangel had always been somewhat of an "odd man out" in the Soviet space program. Although he had made quick progress in converting his old medium-range ballistic missiles, such as the R-12 and the R-14, into space launch vehicles, he had not expressed any explicit interest in the piloted space program. His primary domain was the development of Soviet ICBMs, and he seemed relatively content to limit his activities in the space arena to modest automated satellites for military purposes. Unlike Korolev's flashy Zenit reconnaissance satellites, Yangel's smaller spacecraft were for research on Earth's ionosphere, meteoroid concentration in Earth orbit, cosmic rays, and Earth's magnetic field—areas that had indirect application to military goals." At the meeting in Pitsunda, Yangel proposed a massive new ICBM (the R-36), yet another orbital bombardment system (the R-36-O), and a heavy-lift space launch vehicle (the R-56). The latter would have a launch mass of 1,400 tons and a lifting capability of forty tons to a 200-kilometer orbit, specifications remarkably similar to Korolev's original NI plan." Dazzled by the performance of Yangel's design bureau in the rapid development of new high-performance military systems, the

81 Khrushchev *Nikita Khrushchev* tom 2 pp 149-62 In another one of those curious contradictions of the study of Soviet space history an account of this very important meeting at Pitsunda has been published that differs completely from the one given in the above source See Golovanov *Korolev* pp 717-19 In the latter source the author suggests that it was Khrushchev himself who proposed the change in NI payload mass from forty tons to seventy five tons invoking the need to develop a huge battle station that could not only keep a watch on the U.S. mainland but also serve as a station point for nuclear warheads Khrushchev was concerned about the differences in times for a nuclear attack U.S. missiles could reach the Soviet mainland in eight to ten minutes while Soviet missiles would take twenty to thirty minutes By Khrushchev's reasoning such a battle station to be launched on the NI would go a long way in redressing this imbalance

82 For a detailed summary of the early Yangel satellite launches see V. Agapov 'Marking the First ISZ of the DS Series' (English title) *Novosti kosmonavtiki* 6 (March 10-23 1997) 54-64

83 Khrushchev *Nikita Khrushchev* tom 2 pp 162-66 169-70 S. N. Konyukhov and V. A. Pashchenko 'History of Space Launch Vehicles Development' presented at the 46th Congress of the International Astronautical Federation IAA 95 IAA 2.2.09 Oslo Norway October 2-6 1995 A fourth proposal the R-46 ICBM was also apparently tabled at this time This rocket was an ICBM capable of carrying a fifty megaton warhead The military evidently had no interest in this proposal See also Mikhail Rudenko "Space Bulletin 25 Years From the Landing of American Astronauts on the Moon" (English title) *Vozdushny transport* 29 (1994) 8-9 for descriptions of the Pitsunda meeting

Soviet leadership, especially those in the Communist Party, were very receptive to the new proposals. All three of them were approved for further development.

If Korolev had gone into the meeting with some hope of salvaging his beloved NI, those hopes must have sunk to heretofore unseen depths with the issuance of a formal decree of the Central Committee of the Communist Party and the USSR Council of Ministers on April 16, 1962, titled "On Important Work on Intercontinental Ballistic and Global Missiles and Rocket-Carriers for Space Objects." The decree specified that all work on the NI in 1962 should be limited to work on the draft plan with "necessary economic substantiation of the cost of its creation." The slowdown in the project was clearly related to the conflict between Glushko and Korolev. The decree specified that each of the different versions proposed—that is, the one with Glushko's engines versus the one with Kuznetsov's engines—be appraised in financial terms to come to a decision. While Korolev's lot was sinking, both Yangel and Chelomey gained significantly. The decree approved all three of Yangel's proposals, thus positing the latter's R-56 as a direct competitor to the NI, threatening to completely sink the entire NI project." A second decree in late April granted Chelomey the approval to move ahead with his Pitsunda proposals. With two parallel orbital bombardment systems, Yangel's R-36-O and Chelomey's UR-500, there was little need for a third one from Korolev. The OKB-I chief designer had effectively left Pitsunda empty-handed.

The Keldysh Commission

Since the issuance of the June 1960 decree on approving preliminary work on N series boosters, OKB-I had been engaged in intensive study oriented to selecting a single design configuration for the vehicle. During the period 1960-62, a department at the design bureau studied at least sixty different versions of the booster, from multiple-component configurations to monocoque designs, in both tandem and parallel configurations. Feasibility studies and analyses of each variant's advantages and disadvantages were considered during this phase. Early research had already resulted in the rejection of the parallel or strap-on configuration used on the R-7. Although there were advantages of that design in terms of manufacturing processes, transport, and assembly, the less than optimal mass characteristics as well as the existence of far too many pneumatic, hydraulic, and electrical connections would negate any of the favorable factors. The configuration eventually selected was a three-stage tandem or successive-staged scheme with a semi-monocoque design. In a full monocoque design, the mainframe of the rocket also served as the propellant tanks, thus allowing a number of significant mass savings.

Perhaps the most unusual design characteristic of the chosen NI design was the use of giant spherical propellant tanks. These would be suspended within the main load-bearing outer frame of the rocket, held in place by the forces on them. Engineers theorized that at liftoff, air from the surrounding atmosphere would be ejected by the exhaust streams of the rocket engines into the internal space beneath the lower spherical tank. These exhaust gases would, in theory, form a huge jet engine, which would include the entire lower part of the first stage. Even without the standard expectation of "afterburning" of the rocket engine exhaust, the engineers believed that this phenomenon would provide a significant augmentation of rated thrust. The connections between the first and second as well as the second and third stages would be made up of huge networks of lattice structures, allowing gases to exit at the moment of "hot launch" of the next stage. In the interest of simplicity, the engineers completely dispensed with

84. Semenov, ed., *Rakelno-Kosmicheskaya Korporatsiya*, p. 248.

85. V Pappo-Korystin, V Platonov, and V. Pashchenko. *Dneprovskiy raketno-kosmicheskii tsentr* (Dnepropetrovsk PO YuMZ/KBYu, 1994), pp. 68-69. Note that another source says that Yangel's plan was approved on May 12, 1962. See Khrushchev, *Nikita Khrushchev*, tom 2, p. 165.

the idea of using gimballed rocket engines on the rocket for yaw and pitch, and instead they opted to incorporate a system whereby opposing rocket engines on the stages would develop mismatched thrusts. Roll maneuvers would be carried out by small thrusters fed by gases diverted from the turbopump assemblies.

In formulating a comprehensive economical and technical analysis of the final version, the engineers also addressed the issues of construction, transportation, and assembly of the rocket. One of the major obstacles encountered was moving the vehicle from the manufacturing plant to the launch site at Tyura-Tam. Because the individual stages were expected to be huge, rail transportation was out of the question. Preliminary options included designing the outer shell of the vehicle in such a way that it could be disassembled: similarly, the propellant tanks would be made of petal-shaped strips that would be assembled at Tyura-Tam. Clearly, there was a paramount need for a massive new assembly building at the launch site specifically built for the N1 program—an associated cost that was factored into the preliminary projections.⁸⁶

Of the elements of the N1 studied during this stage, perhaps the most important were the determination of the number of engines required for the first stage of the giant launch vehicle and their thrust. After extensive analysis of the possible options, OKB-1 settled on using a large number of medium-thrust engines instead of a small number of high-thrust engines, as NASA would do in the case of the Saturn V. OKB-1's reasoning was justified by four factors:

- The development and manufacture of engines with thrust levels of 150 tons could be carried out with the current existing technical base without extensive remodeling or construction as would be required for larger engines of 600 to 900 tons thrust.
- Engines with thrusts of 150 tons used on the first stage could also be used on the second stage without significant modification, thus saving an entire level of development as would be required for more powerful engines.
- Because the reliability and capacities of the engines would depend on the quantity of ground tests, greater reliability could be achieved with an equal expenditure for engines of smaller thrust over engines of larger thrust.
- With the use of a large number of engines, a failure of one or two engines would not pose a catastrophic risk to a mission, because the remaining engines could compensate for the failures."

To address the last point, the engineers conceptualized a system known as the Engine Operation Control (KORD) system, which would have the capability to quickly switch off malfunctioning engines as well as units diametrically opposite to the suspect engine. In practice, this system turned out to be much more difficult to operate than was anticipated at the time.

Korolev's engineers addressed the propellant issue in the final stages of the preliminary analysis. Perhaps to give this process a note of impartiality, this analysis was carried out not only at OKB-1, but also at other research institutions, such as NII-4. It seems that cost-benefit and technical analyses were conducted of two complete variants of the N1: one with Korolev's favored LOX-kerosene combination and one with Glushko's N_2O_4 -UDMH combination. The analyses clearly proved that the latter was far inferior to the former in terms of operational characteristics. The storable propellant variant would decrease the potential payload mass (while keeping the launch mass constant), lower specific impulse, increase propellant mass (because of higher elasticity of the components), and significantly increase the costs associated with the development of a large industrial base for storable components." All the

86. Igor Afanasyev. "N1: Absolutely Secret Part II" (English title). *Krylya rodiny* no. 10 (October 1993) 1-4.

87. Semenov, ed.. *Raketno-Kosmicheskaya Korporatsiya*, p. 249.

88. *Ibid.*, p. 250.



This famous picture is of the so called "Three Ks" of the Soviet military industrial complex from far left are Sergey Korolev from the missile program Igor Kurchatov from the atomic bomb program and Mstislav Keldysh from the Academy of Sciences On the extreme right is Korolev's First Deputy Vasily Mishin The photograph dates from July 1959 when Korolev Keldysh and Mishin visited Kurchatov's institute (files of Peter Gorin)

engines on the cryogenic variant were designed to be of the closed cycle type, allowing higher combustion pressure and better performance. Engineers chose such a scheme no doubt because both OKB-1 and Kuznetsov's OKB-276 had experience with closed cycle units. In contrast, all of Glushko's aborted efforts at designing cryogenic engines in the 1950s and early 1960s had been of the open cycle type, better known in the West as "gas generator cycle" engines.

The research and development effort leading to the preparation of the NI draft plan was not only carried out at OKB-1. At Korolev's insistence, a large number of other design bureaus and scientific-research institutes were involved in the process "for reducing the number of critics we would run up against in subsequent work. That way, the component manufacturers would know that their ideas had been taken into consideration from the very beginning of the design process."⁸⁹ At OKB-1 itself, the complete effort was directly overseen by Korolev and his immediate deputy, Vasily P. Mishin, both perhaps seeing the future of their design bureau in the project. For someone who was primarily a manager rather than an engineer at this point in his life, Korolev's personal contribution to the design of the NI was remarkably significant. For example, a set of notes to a deputy chief designer authored by Korolev on February 5, 1962, detailed recommendations and comments on a variety of issues, including launch mass, engines, payloads, manufacturing, assembly, welding of parts, propellants, storage facilities, and ground testing. In addition, he had detailed suggestions for how drawings of various NI systems should be prepared, as well as standard managerial assignments on the project.⁹⁰

⁸⁹ R. Dolgopyatov, B. Dorofeyev and S. Kryukov "At the Readers Request: The NI Project" (English title) *Aviatsiya i kosmonautika* no. 9 (September 1992) 34-37

⁹⁰ A. Yu. Ishlinskiy ed. *Akademiya S. P. Korolev ucheny inzhener chelovek* (Moscow: Nauka, 1986) pp. 195-97. Note that the NI is not actually mentioned anywhere in the source because the existence of the rocket was still classified information at the time. The deputy chief designer in question was S. S. Kryukov, one of the primary designers of the NI rocket. A declassified version of these same notes has been published as S. P. Korolev "Notes on the NI" (English title) in B. V. Raushenbakh ed. *S. P. Korolev i ego delo: suet i teni v istorii kosmonavтики izbrannyye trudy i dokumenty* (Moscow: Nauka, 1998) pp. 355-57.

The forty-five-year-old Mishin, officially OKB-1's First Deputy Chief Designer for Planning-Design Work, was one of the most aggressive individuals in the design bureau's "high command." An outspoken and assertive engineer, he had served as Korolev's right-hand man since the establishment of OKB-1 as an entity in 1946. His particular engineering specialties were ballistics, dynamics, aero-gas dynamics, and stress, but he oversaw almost every single program at the design bureau. By his own account, he was "groomed" by Korolev to be his successor. In fact, at every point in the history of the design bureau, Mishin was promoted or given awards together with Korolev. In 1961, after Gagarin's flight, Korolev had nominated Mishin for an unprecedented second Hero of Socialist Labor award, reserved only for chief designers: the proposal was ultimately rejected "at the highest level," and instead Mishin was conferred the less prestigious Order of Lenin.⁹¹

Mishin's own relationship with Korolev was dictated to a great extent by the idiosyncrasies of both personalities. Mishin later recalled, "It should not be thought that just because I was Korolev's first deputy, this meant that I was both a very close friend and counselor. . . we would not speak for weeks because of some disagreement." Both apparently agreed that they "would only sort out [their] differences in private with no witnesses in attendance." While he was certainly one of the most creative engineers at the design bureau, he was endowed with less than stellar diplomatic talents, putting him into confrontations on many occasions with various people. More passionate about the use of LOX on missiles and rockets than even Korolev, Mishin had continuously and vigorously argued the oxidizer's use on the R-9 and the NI at every step of the way. Mishin's relationship with Glushko was even worse than Korolev's, perhaps resulting from an incident in 1960 when Glushko had insulted Mishin to his face in front of a group of leading designers amid a discussion on the merits of closed cycle versus open cycle LOX engines." If Korolev had any inclination to compromise with Glushko on the propellant issue, he was most likely swayed by Mishin, who was adamantly against capitulating to the powerful engine designer.

Apart from Korolev and Mishin, the importance of the NI project in the framework of OKB-1's long-range plans was demonstrated by the inclusion of no less than eight other deputy chief designers at the design bureau. They were to oversee various aspects of the design work: Konstantin D. Bushuyev and Sergey S. Kryukov (planning and computational-theoretical work), Sergey O. Okhapkin (design and strength), Boris Ye. Chertok (guidance systems), Mikhail V. Melnikov (rocket engines), Leonid A. Voskresenskiy and later Yakov I. Tregub (testing systems), Anatoliy P. Abramov (ground complexes), and the famous Mikhail K. Tikhonravov (general thematic research, continuing his pioneering work in the evolution of the Soviet space program)."

Korolev signed the initial fifteen-volume draft plan for the NI on May 16, 1962.⁹⁶ The draft plan for the related GR-1 missile had already been completed and signed a month earlier. The NI draft plan, as prepared at the time, included a detailed step-by-step plan for the program, encompassing different variants of the basic NI vehicle. In its basic configuration, the vehicle would be a three-stage (each known as Blok A, Blok B, and Blok V) rocket augmented by two upper stages (Blok G and Blok D). Perhaps responding to criticism on moving from the modest Vostok launcher to the giant NI, the May 1962 draft plan included proposals for three progressively powerful launch vehicles—the NI, NI I, and NI II—all sharing common elements. A fourth rocket, the GR-1, would test the remaining components of the NI

91 Yu A. Mozzhorin *et al.* eds. *Dorogi v kosmos* I (Moscow MAI 1992) pp 119-20

92 Tarasov "Missions in Dreams and Reality" p 4

93 Vasilii Mishin "We Would Make You Work to the Best of Your Ability" *Aerospace journal* no 1 (January-February 1997) 76-78

94 Chertok *Rakety i lyudi Fili Podlipki Tyuratam* p 343

95 Semenov ed. *Raketno Kosmicheskaya Korporatsiya* p 250

96 Golovanov *Korolev* p 711

The NII would use the second, third, and fourth stages of the NI, omitting the giant first stage. The NIII would use only the third and fourth stages of the base NI and a third stage transferred from the second stage of the R-9A ICBM. There were two significant advantages to this plan. First, it would make the design and flight testing of the basic NI booster much more efficient by testing vital stages and instrumentation on smaller sized test articles. Second, it would introduce three new classes of launchers for satisfying very different mission requirements. The GR-I orbital bombardment system would be almost the same as the proposed NIII: the only difference would be the use of the NI's critical fifth stage (Blok D) as the GR-I's third stage. This particular stage, designed for use in vacuum conditions, was required to carry out multiple firings on the same mission: vigorous testing on the GR-I would qualify the engine for nominal operation on the base NI. In effect, with such a progressive booster program, by the time the NI flew its first mission, all the stages, save the first stage, would have already been tested and qualified in flight conditions. The payload capabilities and launch masses of the three N series boosters would be:

Booster Variant	Stage Designations	Launch Mass	Payload Capability to Earth Orbit
NI (or "IIA52")	Blok A (Stage 1) Blok B (Stage 2) Blok V (Stage 3) Blok C (Stage 4) Blok D (Stage 5)	2.160 tons	75 tons
NII ("IIA53")	Blok B (Stage 1) Blok V (Stage 2) Blok C (Stage 3)	700 tons	20 tons
NIII ("IIA54")	Blok V (Stage 1) Blok C (Stage 2) R-9A Blok B (Stage 3)	200 tons	5 tons ⁹⁷

The proposed requested amount for the manufacture of the first ten rockets of the series was 457 million rubles.⁹⁸

A special "expert commission" affiliated to the USSR Academy of Science examined the complete project materials on the NI project, spanning twenty-nine volumes and eight appendices, during an intensive series of meetings held between July 2 and 16, 1962. Members of the commission included the leading chief designers, industrial representatives, military officers, scientists, and Party apparatchiks involved in the Soviet space program. Academician Mstislav V. Keldysh, the President of the Academy of Sciences, served as chairman. As one would expect, the primary issue of contention was the selection of propellants—a conflict that threatened to bring the project to a complete standstill. Both Glushko and Korolev were allowed to make cases for their respective variants—the former with the N_2O_4 -UDMH combination and the latter with the LOX-kerosene combination. Glushko supported his position with several argumentative points. He believed that:

⁹⁷ Dolgopyatov, Doroieyev and Kryukov, "At the Readers Request The NI Project". Semenov ed. *Raketno Kosmicheskaya Korporatsiya* p 250

⁹⁸ S. Kryukov. "The Brilliance and Eclipse of the Lunar Program" (English title) *Nauka i zhizn* no. 4 (April 1994) 81-85

The creation of very powerful LOX-based engines would be the source of paramount problems because of such factors as intermittent combustion and the need to protect the combustion chamber and nozzle walls from overheating. His design bureau had faced these problems in the development of several single-chamber LOX-kerosene engines (in particular the RD-110 and RD-111) during the 1950s and 1960s.

The creation of very powerful LOX-based engines would be plagued by high-frequency oscillations, which had served as significant obstacles in the development of the RD-110 and RD-111.

The use of storable propellants, which produce steady combustion in the engine chamber at temperatures 280 to 580 degrees Centigrade lower than those with LOX, would allow for a quicker development phase.

The use of hypergolic or self-igniting propellants would allow for a simpler engine design. The development of storable propellant engines for the NI would not necessitate significant additional resources on his part—that is, take less time and money—because his design bureau was already developing similar engines for Chelomey's boosters (in particular the RD-253).

Korolev countered each point based on the analysis conducted at his design bureau as well in other organizations. His belief was that:

Glushko's concerns about the problems associated with the development of the LOX-kerosene engine were invalidated to a great degree because OKB-1 was advocating the use of a closed cycle scheme for the design of the engines—a design that circumvented most, if not all, of the problems enumerated by Glushko. OKB-1 and OKB-276 already had significant experience in the design of closed cycle rocket engines (with the SI.5400 and NK-9 engines). In his report, Korolev stressed that:

All arguments about the difficulty of developing oxygen-kerosene engines were based only on the experience of the OKB of Glushko of developing [liquid-propellant rocket engines] with an open scheme, in which the oxidizer (oxygen or nitrogen tetroxide) is delivered to the chamber in a liquid and cold state. It should be emphasized that the difficulties to which the OKB of Glushko refer to *have* nothing to do with the engines *having* been adopted for the NI with a "closed" scheme, in which the oxidizing agent (oxygen) is delivered to the chamber in a hot and gaseous state. . . .⁹⁹

The use of storable propellants would significantly decrease the specific impulse of the engines, thus lowering payload mass.

The use of storable propellants would significantly increase the mass of the propellant tanks.

The use of cryogenic propellants would be significantly less expensive than storable propellants. In the case of the one-time capital expense for the development of the engines, the former would be two times less expensive; in the case of the components themselves, the cost of the former would be seven times less expensive.

The use of storable propellants would dramatically increase the danger in working with the rocket not only because of the high toxicity of the propellants, but also because of their hypergolic characteristics. On this point, Korolev cautioned:

99. Vetrov, "The Difficult Fate of the NI: Part II," p. 20

These components are self-igniting and toxic, which increases the potential of pressurizing the components. Especially great is the danger to the service personnel at times of abnormal functioning of the aggregates and the systems.¹⁰⁰

The arguments went back and forth for days without much compromise, sometimes fracturing the modicum of unity among the other chief designers. Eventually, the commission arrived at a consensus: it voted to recommend Korolev's LOX-kerosene variant, adding in its official report that the NI draft plan fulfilled "high scientific-technical standards" that had been originally demanded in the initial proposals." Glushko was aghast. Despite the decision, he insisted on a total revision of the NI plan, allowing for the use of N_2O_4 -UDMH; he simply refused to make the LOX engines necessary for the project. Several other prominent chief designers, including Barmin and Ryazanskiy as well as Strategic Missile Forces Lt. General Mrykin, apparently made great efforts to mediate the issue by having Glushko participate in the project, but the two designers refused to work together. By default, the job to develop the NI engines ended up in the lap of Nikolay D. Kuznetsov of Kuybyshev.

The July 1962 decision by the Keldysh Commission effectively fractured the space program into the Korolev and Glushko camps, destroying any semblance of unity that may have existed during the Sputnik days. Although the break between the two was over purely technical issues, the repercussions were far-reaching: the two giants of the Soviet space program would not live to cooperate on another project. Korolev had turned his back on the most powerful and successful rocket engine designer in the country, resorting to someone who had almost no experience in the field, while Glushko lost his role in what was to be the most expansive and greatest project in the history of the Soviet space program. In a sense, it was the end of the beginning of the dramatic road from Sputnik. Western observers did not even suspect the break between the two until more than a quarter of a century later during the glasnost era. Over that twenty-five-year period, there was only one single hint of the discord, and it came from the pen of Nikita Khrushchev himself. In his smuggled-out memoirs, published in 1974, he had written:

The principal designer of the [R-7] booster was Korolev's friend and collaborator, whose name I forget. The best booster rocket in the world won't make a broomstick fly. So while Korolev designed the rocket, his colleague designed the engine. They made an excellent team. Unfortunately, they split up later. I was very upset and did everything to patch up their friendship, but all my efforts were in vain.¹⁰²

The troubled NI was conceived during an unexpected window of opportunity in 1960. Its path to birth was marred not only by the Korolev-Glushko battle, but also marked indifference from the Soviet leadership. At the Pitsunda meeting in February 1962, Khrushchev had been remarkably ambivalent about the NI, instead forcing through a number of alternative proposals from Yangel and Chelomey. There had been some cursory orders to continue "paper studies," which eventually resulted in the Keldysh Commission's positive appraisal of the effort in July. Despite the acrimony over the propellant issue, the commission's recommendations

100 The summary of the arguments are taken from *ibid* Semenov ed *Raketno Kosmicheskaya Korporatsiya* pp 249-51 Alanasyev 'NI Absolutely Secret Part II' Kryukov "The Brilliance and Eclipse of the Lunar Program" OKB I's complete defense of the NI draft plan has been published as S P Korolev "Report on the Powerful NI Carrier Rocket at the Meeting of the Expert Commission" (English title) in Raushenbakh ed *S P Korolev i ego delo* pp 363-82

101 Kryukov "The Brilliance and Eclipse of the Lunar Program"

102 Nikita Khrushchev *Khrushchev Remembers: The Last Testament* (Boston: Little Brown & Co. 1974) pp 46-47

clearly pushed the project into overdrive; within two months, the Soviet leadership was finally ready to give the go-ahead. On September 24, 1962, the USSR Council of Ministers and the Central Committee of the Communist Party issued a joint decree (no. 1021-436), which approved full-scale work on the development of the N1 booster, its component N11 and N111 launch vehicles, and the CR-1 orbital bombardment system. Beginning with the bold challenge to achieve "the goal of ensuring the leading position of the Soviet Union in the exploration of space," the decree called for work on the creation of the 2,200-ton booster with a lifting capability of seventy-five tons to low-Earth orbit.¹⁰³ In versions with upper stages using LH₂, the booster would have lifting capacity of about ninety to 100 tons. The September 1962 decree enumerated a fairly ambitious program leading to the first launch of the N1 in 1965.¹⁰⁴ Although it would be the most powerful space launch vehicle ever built in the Soviet Union, it would still fall short of the baseline capability of the early version of the equally giant Saturn C-5, which was formally approved by NASA Headquarters on January 25, 1962.¹⁰⁵

Literally hundreds of organizations were invited to participate in the N1 program, notable only by the absence of Glushko's OKB-456. Korolev's OKB-1 would serve as the primary contractor responsible for overall design. Its affiliate Branch No. 3, located at Kuybyshev and headed by Deputy Chief Designer Dmitriy I. Kozlov, was assigned to oversee manufacture and production at its adjacent Progress Plant. As in the postwar days of building modified A-4 missiles, the inertial guidance and radio control systems would be developed by NII-885 under Chief Designers Pilyugin and Ryazanskiy, respectively. GSKB SpetsMash under Chief Designer Barmin would design and build a new large launch complex at Tyura-Tam specifically for N1 operations. The development of the main rocket engines of the base N1 variant were, of course, tasked to OKB-276 at Kuybyshev. Other major subcontractors included NII-4 (for ground telemetry complexes); OKB-12 (for propellant loading systems); NII-88, the Central Aerohydrodynamics Institute, and NII-1 (for aerodynamics research); the B. Ye. Paton Institute of Welding and NITI-40 (for manufacturing processes); and NII-229 at Zagorsk (for ground testing of all components)."

The Keldysh Commission and the subsequent governmental decree also addressed the problematic issue of transportation and assembly of the N1. Because the entire rocket would not be transportable in one piece, the commission recommended further research on means to transport the rocket via air, sea, or land. OKB-1's initial proposal was to manufacture the components of the rocket at the Progress Plant at Kuybyshev, assemble and test the entire rocket at the same location, disassemble the vehicle, and then transport the parts to Tyura-Tam. At the launch site, the parts would then be assembled and tested once again, which would be carried out horizontally in a massive assembly building near the pad area. There was apparently much

103. Vetrov. "The Difficult Fate of the N1: Part II"

104. The decree stated that (1) autonomous firing work on the engines of the third, second, and first stages would be finished in 1964, 1965, and 1965, respectively; (2) cluster firing work on engines on the stages and units would be carried out from 1964 to the first quarter of 1965; (3) the manufacture of two complexes of ground equipment at Tyura-Tam would be in 1964; (4) preparation in 1964 of launch and technical sites would ensure the first launch of the rocket; (5) work on ground complexes together with the rocket would be in 1965; and (6) completion of construction of the launch position and converting to operational activities would be in 1965. See Semenov, ed. *Raketno-Kosmicheskaya Korporatsiya*. p. 251

105. Roger E. Bilstein, *Stages to Saturn: A Technological History of the Apollo/Saturn Launch Vehicles* (Washington, DC: NASA SP-4206, 1996), pp. 58-59. The low-Earth orbit capability of the Saturn C-5 was projected as 113 tons at the time.

106. Dolgopyatov, Dorofeyev, and Kryukov, "At the Readers' Request. The N1 Project": Semenov, ed., *Raketno-Kosmicheskaya Korporatsiya*. pp. 248-49; Dorofeyev. "History of the Development of the N1L3 Moon Program."

resistance to this idea because it involved the design and construction of a massive new building at Tyura-Tam dedicated exclusively for the N1. Studies in 1962–63 explored several alternatives, which included using a single dirigible with a lifting capacity of 250 tons or using two Katamaran-type connected dirigibles. Land transportation in the form of a major highway was also considered but dismissed by the Ministry of Defense because of the costs involved in building a 1.300-kilometer road from Kuybyshev and Tyura-Tam. Eventually, by mid-1963, the military conceded their position and agreed on the original OKB-I proposal to transport the rocket part by part to the launch site and assemble it in a giant building. The giant spherical propellant tanks themselves would be manufactured in the form of flower petals, which could be assembled and disassembled as needed.¹⁰⁷

When the N1 rocket was originally conceived in 1960, the issue of suitable payloads for the booster was left sufficiently vague so as to include a variety of missions. In fact, unlike NASA's Saturn C-5 launch vehicle, the N1 was never proposed as a rocket for a dedicated single mission such as a lunar *landing* project. Conceptualized as "a universal launch vehicle," the series of decrees in 1960–62 was remarkably ambiguous as to its ultimate use, merely alluding to unspecified military, scientific, and interplanetary missions of the future Soviet space program. Korolev, clearly cognizant that the Ministry of Defense would be the primary funding conduit for the project, continually targeted the rocket for use on vague military projects. It was a "Trojan horse" strategy that had worked well for the R-7 ICBM, and like the R-7 effort, he delicately phrased his requests so as not to alarm military officials into believing that funding the N1 would siphon off resources from the huge strategic arms buildup in the 1960s. This trade-off between the scientific and military needs of the country, while symptomatic of the nuances of civilian-military relations in many other countries, was accentuated in the Soviet Union to a great extent by the inherent outgrowth of the space program from the ballistic missile effort.

The original June 1960 decree had tasked the Ministry of Defense, in cooperation with the defense industry, to formulate a set of missions for the use of new spacecraft for exclusively military purposes. But space as a component of strategic military policy had clearly not emerged at such an early period: space simply did not "fit into then-existing notions of defense" in the Soviet Union. The Ministry of Defense tactical-technical requirement document for the N1 had not been issued by 1961, prompting Korolev to action. In a letter dated January 15, 1961, to Commander-in-Chief of the Strategic Missile Forces Marshal Moskalenko, Korolev reminded Moskalenko that no such document had been received by OKB-I. In a second letter signed the same day, he addressed then-Chairman of the State Committee of Defense Technology Konstantin N. Rudnev:

The *in-depth* study of the project plan and the *discussions* that were carried out with the leading chief designer-workers and a number of specialists and scholars leads to the conclusion that all the enumerated space objects *have* military importance. [There are a number of ways] to reach new standards in the sphere of rocket technology . . . necessary for the successful solution of the problems the defense industry faces nowadays. . . . The creation of the heavy carrier N1 occupies a special place among *these*.¹⁰⁸

Korolev added that the heavy booster could play important roles in the orbiting of heavy space stations, which could provide ideal conditions for conducting space-based

¹⁰⁷ Vetrov "The Difficult Fate of the N1 Part II" Dorofeyev "History of the Development of the N1 L3 Moon Program" Kryukov "The Brilliance and Eclipse of the Lunar Program" Afanasyev "N1 Absolutely Secret Part II"

¹⁰⁸ *Ibid*

reconnaissance, carrying out early warning missions for detecting launches of foreign strategic missiles and nuclear explosions, and determining levels of solar radiation. The military remained unusually uninterested in the NI through 1962, perhaps dazzled by concurrent proposals of Chelomey and Yangel, such as the UR-500 and the R-56. Perhaps the military simply believed that the more modest payload capabilities of these latter two boosters would be sufficient to meet any possible demands of the Ministry of Defense.

The July 1962 decision in favor of the NI by the Academy of Sciences did not help either. According to Korolev's First Deputy Mishin, the "decision of the Academy of Sciences was supposed to define the objectives and produce a proposal for the development of space vehicles to be inserted into space by [the NI]." "The academy refrained from doing so, leaving the project in somewhat of a lurch. The final governmental decree in September of the same year also did not address the question of specific payloads for the booster, merely referring to the catch-all "universal launcher" terminology. The dearth of suggestions from either the Ministry of Defense or the academy did not prevent a plethora of internal OKB-I studies on possible NI payloads. Much of these in the early 1960s were clearly focused on military applications and remain classified amid the still-secret archives of the design bureau. It is known, however, that thematically speaking, these military spacecraft were geared toward exotic goals, such as anti-satellite and anti-ballistic missile defense, something of a precursor to the U.S. "Star Wars" program of twenty years later. According to one of the "fathers" of the NI, OKB-I Deputy Chief Designer Kryukov, the NI was to launch into orbit multiple spacecraft as well as giant spacecraft "for accomplishing inspection, control and . . . means of destruction."¹⁰ While the details still remain obscure, it is clear that none of these studies of a military "Orbital Belt" were considered anything more than proposals: they remained consigned to paper, proposed only to ensure the survival of the NI project as an insurance policy to the primary financiers of the program.

To Mars

Beginning with Tsiolkovskiy in the early part of the century, Soviet space scientists had consistently targeted the planet Mars as the singular most important objective in plans to explore space. Piloted flight to Mars had figured prominently in the famous June 1960 decree on the Soviet space program; Korolev's draft of the decree includes mention of an Object KMV for sending cosmonauts around Mars and back to Earth again. Proposals for such missions remained on the forefront of the Soviet space program's agenda after Sputnik and Vostok, seemingly unaffected by President Kennedy's 1961 pronouncement on the challenge to reach the Moon prior to the end of the decade. To a great extent, it was Korolev's personal interest in Mars, perhaps motivated by the dreams of his idealistic youth spent poring over the works of Tsiolkovskiy. It had been a long thirty years since the late Fridrikh A. Tsander's "Onward to Mars!" exclamation, and now Korolev was in a position to make that call for arms a reality. Initial exploratory work on this issue began as early as 1959, when a group under Gleb Yu. Maksimov at OKB-I began toying with designs for a large interplanetary spaceship capable of flight to the other planets. Maksimov, a veteran of Tikhonravov's studies on artificial satellites in the early 1950s, was at the same time heading OKB-I's work on automated lunar and interplanetary stations. It was the research under Maksimov from 1959 to 1960 that may have been the primary reason for freezing the NI payload mass at seventy-five tons, which was sufficient for a piloted interplanetary spacecraft.

¹⁰⁹ Mishin, "Why Didn't We Fly to the Moon?"

¹¹⁰ Kryukov, "The Brilliance and Eclipse of the Lunar Program," p. 84

The research on an interplanetary spacecraft culminated in a proposal for a Heavy Interplanetary Ship (TMK), which was aimed at "rapid realization of the program with the resources at hand." Maksimov's plan called for the NI to launch a seventy-five-ton payload into Earth orbit, composed of a transplanetary boost stage and a fifteen-ton spacecraft with a three-person crew. Because there was still much uncertainty concerning the reliability of the NI at the time, a second backup option involved the launch of an uncrewed TMK and its booster stage into Earth orbit by the NI, followed by delivery of the crew in a Vostok-type spaceship to the TMK. Following systems checkout in Earth orbit, the TMK would be sent on a trajectory toward Mars using a conventional LOX-kerosene acceleration stage, conduct a flyby of the planet, and then, using Martian gravitational pull, fly back to near-Earth space. At that point, a detachable return apparatus with the crew would separate and land on Soviet territory by means of parachute.

On paper, the cylindrical TMK had a length of about twenty meters and a maximum diameter of four meters. The spacecraft had three main compartments: one for biological research, one for instrumentation, and a pressurized section for the crew. Their volumes were seventy-two, fifty, and twenty-five cubic meters, respectively. The instrumentation compartment would contain a specially shielded radiation shelter for the crew during peak periods of solar activity as well as a "chlorella reactor" for generating the crew's food needs. The spacecraft would be rotated around its axis through most of the two- to three-year-long mission to generate artificial gravity. Large solar panels would ensure a constant power supply during the mission. The initial technical design for this conception of the TMK, known as the TMK-1, was completed on October 12, 1961.

Maksimov's group, up to then involved only in the design of automated spacecraft, was an unusual choice to design such a complex spacecraft, and this seems to have raised the specter of competition within OKB-1. The group of designers led by Feoktistov, who had served as the chief architects of the Vostok spacecraft and were afraid of being left behind by the Maksimov group, took it upon themselves to join the fray and began work "in an underground manner" with a plan to surprise Korolev with their diligence. Curiously, both men reported to



This is a model of the Heavy Interplanetary Ship (TMK) proposed in the early 1960s to carry humans around Mars on a multiyear long trip. A proposed Earth orbital station dating from the same period also used the same design as this interplanetary spacecraft. Note the docking nodes in the middle of the cylinder for visiting spacecraft. Several floors are visible on the lower half of the model. (copyright Mark Wade)

111 I. B. Afanasyev, "Unknown Spacecraft (From the History of the Soviet Space Program)" (English title). *Znaniye novoye v zhizni. nauke, tekhnike: seriya kosmonavtika. astronomiya* (December 1991) 1-64.

112 Raushenbakh, ed., *S. P. Korolev i ego delo*, p. 623. Semenov, ed., *Raketno-Kosmicheskaya Korporatsiya*, p. 279. Afanasyev, "Unknown Spacecraft", Mikhail Rebrov, "Saga from the Archives of Document No. 23891 and an Unknown Space Project" (English title), *Krasnaya zvezda*, May 13, 1995, p. 6; Ishlinskiy, ed., *Akadernk S. P. Korolev*, pp. 99-100.

Tikhonravov, who as Department No. 9 chief oversaw both the Maksimov and Feoktistov groups. On the evening of April 30, 1960, after a presentation by Maksimov on his TMK plans, Feoktistov unfurled the results of his own preliminary research. Korolev was apparently ecstatic that there was such interest in Mars." Feoktistov got the green light to move ahead on his proposal, which in all ways was far more ambitious than Maksimov's plan because it involved the landing of humans on the surface of Mars.

The Feoktistov variant, also called the TMK, would be assembled in orbit via two N1 launches with seventy-five-ton payloads, making a grand total of 150 tons in Earth orbit. The linked-up spacecraft resembled a daisy flower with a compact seven-kilowatt nuclear reactor in the center and radiator-emitters serving as petals. The crew cabin was located at one end of the cylindrical stem. Primary propulsion would be performed by a set of low-thrust (seven and a half kilograms) electrical rocket engines working off a nuclear energy source. These engines were to fire slowly over a period of months as the TMK gathered enough speed to boost itself out of Earth orbit toward Mars. At the Red Planet, the entire spacecraft would enter orbit, followed by separation of the landing vehicle, which would alight on the surface. The landing vehicle itself was composed of five "platforms": one for the crew cabin and drilling equipment, one for a glider for conducting reconnaissance over the Martian surface, two rockets for returning the crew back into Martian orbit, and one for nuclear power sources. Over the course of one year, the mobile vehicle would move across the Martian surface carrying out scientific research while transmitting information back to the orbiting vehicle. A portion of the lander would then take off, dock with the orbiter, and then head back to circumterrestrial space with the aid of the same electrical rocket engines. The total mission for a ten-person crew would last three years.¹¹⁴

OKB-1 expended a significant amount of effort on both these projects in the early 1960s, diverting resources especially to the development of electrical rocket engines working on nuclear energy, as well as the development of closed-loop life support systems. Electric rocket engines, which unlike regular liquid-propellant engines allow the working fluid to be accelerated to discharge velocities, had been a focus of intensive research since Glushko's pioneering work in the early 1930s. Post-Sputnik research work on such propulsion systems began anew at OKB-1 in 1958 and were coordinated to a great extent on the plans for the TMK project. The design bureau, working hand-in-hand with the Physical-Power Institute at Obninsk, preferred using a nuclear power source for the engines; the research was thus carried out in parallel with research on nuclear rocket engines. The preliminary studies conclusively proved that electrical rocket engines would significantly increase the performance characteristics of the TMK with regard to multiyear-long missions. The June 1960 decree on the Soviet space program approved a proposal by OKB-1 to commence full-scale work on the electric engines, and by 1962-63, many institutes and design bureaus were involved in the project."

113 Ishlinskiy, ed., *Akademi S P Korolev*, pp. 99-100

114 *Ibid.*, Semenov, ed., *Raketno-Kosmicheskaya Korporatsiya*, p. 280; Alanasyev, "Unknown Spacecraft". Igor Afanasyev, "Piloted Flight to Mars . . . A Quarter Century Ago" (English title), *Vestnik vozdushnyy flota* no. 7-8 (1996) 103-05. There were different conceptions of the TMK lander proposal. For example, one pre-draft plan finished in May 1966 consisted of a six-section TMK spacecraft. These included (1) an expeditron ship to carry the crew during the mission, (2) an orbital complex with living and working compartments, (3) a descent apparatus for descending to the Martian surface, (4) a return apparatus for carrying the crew from the surface back to the expedition ship, (5) a return rocket for sending the return apparatus from the surface of Mars either into Martian orbit or on a trajectory back to Earth, and (6) a planetary station for piloted research on the Martian surface. At least four different mission profiles were considered for this ambitious proposal, all using the N1. Raushenbakh, ed., *S P Korolev i ego delo*, pp. 633-34.

115 Semenov, ed., *Raketno-Kosmicheskaya Korporatsiya*, p. 409; G. V. Petrovich, ed., *The Soviet Encyclopedia of Space Flight* (Moscow: Mir Publishers, 1969), 120. Among the other institutions involved in the research on electric rocket engines were NII-1, NII-88, OKB-670, TsAGI, TsIAM, IAE, VNIEM, MAI, OKB-456, OKB-586, and OKB Zarya

The research on electrical engines was a serious component of the TMK studies and, as one of Korolev's leading ballistics experts, Mikhail S. Florianskiy, recalled, critical in affecting the design of the spaceship itself:

The interplanetary ship was of the form resembling a rifle bullet with a hatch "at the head." I took part in the computations and showed Sergey Pavlovich [Korolev] that by using electric rocket engines of low thrust for movement to Mars, the launch mass to orbit could be possibly reduced to 125 tons. Then for approximately two years, the interplanetary ship would fly around Mars with its crew of three people.

By April 1963, OKB-1 Deputy Chief Designer Bushuyev was ready to present a report to the Council of Chief Designers titled "On the TMK for the NI," which summarized all the possible options for the interplanetary spaceship. The two most serious options considered at that point involved a massive 680-ton spaceship using chemical propellant engines assembled in Earth orbit from ten NI launches and a seventy-five-ton spaceship launched on a single NI launch equipped with electric rocket engines."

The question of developing life support systems that could function autonomously for two to three years was the subject of serious attention. In 1962, Korolev created a special department at OKB-1 under Ilya V. Lavrov to specifically design and develop a closed-cycle life support system designated the Scientific-Experimental Complex (NEK). For obvious reasons, existing life support systems based on nonrenewable resources of water, food, and air were not considered for the project. Lavrov opted not to use chemical sources for regenerating resources, turning instead to biological systems, which could replicate the closed ecological system of Earth on a micro level. To simplify the process of early research, only water and oxygen were considered essential for recycling. Some of the required water would be produced from moisture breathed into the internal atmosphere of the ship and purified by ion-exchange resins. Bodily wastes would provide the remaining portion using physio-chemical and biological processes. Oxygen would be regenerated from carbon dioxide exhaled by the cosmonauts by using chiorella-type algae, the latter also being used to treat human waste. Food for the multiyear-long trip would be stored in freeze-dried form selected on the basis of calorific value and specific mass. Vegetables grown in special hydroponic greenhouses would augment the primary food rations, allowing the crew to economize in terms of food mass by 20 to 50 percent. Large external solar reflectors, instead of internally generated light, would deliver sunlight to the greenhouses."

Given the limited resources and funding available, Maksimov's Mars flyby design was considered a more realistic proposition than Feoktistov's landing expedition. Initial plans in the early 1960s forecast a circum-Martian flight as early as 1968-70. The landing project, on the other hand, was considered a distant prospect, ready for realization perhaps in the early 1970s. Feoktistov himself recalled that although Korolev was well aware that the landing was not a realistic prospect of the near future, the thought of developing such a spacecraft "excited him terribly."¹¹⁶ By all accounts, he considered these seemingly fantastic proposals more engineering problems than unrealistic dreams, continually keeping close watch on the work of

¹¹⁶ Golovanov Korolev p 768

¹¹⁷ This was evidently part of a larger report presented by Bushuyev on April 22, 1963, to the Scientific Technical Council of OKB-1 which was titled "Proposals on the Development of Space Objects on the Basis of the NI Carrier." One early conception of a Mars landing mission envisioned the use of twenty to twenty-five launches allowing for the assembly of a huge 1,630-ton spaceship in Earth orbit. A nominal Mars landing mission of this Martian Piloted Complex (MPK) would take two and a half years. After a landing mission, the crew would return to Earth in fifteen-ton reentry module. See Afanasyev, "Piloted Flight to Mars."

¹¹⁸ Afanasyev, "Unknown Spacecraft" Colovanov Koroleu p 768

¹¹⁹ Golovanov Koroleu p 768

both Maksimov and Feoktistov. This is underlined to a great extent by a set of priceless notes in Korolev's own handwriting, which were declassified nearly twenty years after he had jotted them down in September 1962. He goes into detail on a variety of factors in the development of the TMK, including artificial gravity, life support systems, biological investigations, and so on. He also mentions a Heavy Orbital Station (TOS), which would have many design commonalities with the TMK. As Korolev wrote, "maybe the Heavy Interplanetary Station will be the Heavy Orbital Station during the first phase, thus contributing to the reliable debugging of all systems in the vicinity of the Earth, e.g. during one year." Very preliminary work on a unique variant of the TOS, specifically for military goals, had also begun at OKB-I by 1960. These objectives included reconnaissance, anti-satellite missions, the targeting of ground assets, and communications. An initial predraft plan for this station was completed as early as May 3, 1961. This concept may have eventually evolved into a huge four-story space station named *Zvezda* ("Star"), which was reportedly the focus of some research in the mid-1960s.¹²¹

Until much of the work at OKB-I was declassified in the late 1980s and early 1990s, the work on the TMK and the TOS, like many other projects, was consigned to the black hole of Soviet space history. But the program was very real, and it tied up a modicum of resources within OKB-I. Although the NI was developed as "a universal launcher" in the early 1960s, barring unspecified military satellites, the primary payload of the giant booster was a piloted Martian spaceship. In many ways, in that time period, the ambitions of the Soviet space program were much more far-reaching than NASA's seemingly dramatic road to the Moon. For the Soviets, and in particular Korolev, the Moon was certainly a worthy goal, but it was not the end-all of everything: it was merely an important step in the ultimate goal of sending cosmonauts to the surface of Mars. Thus, while President Kennedy's speech awoke a sleeping giant into action in the United States, the Soviets continued to persevere slowly but deliberately on their own road to Mars, first with Earth-orbital stations serving as bases and finally with interplanetary ships. It was a step-by-step plan that was remarkably faithful to half-century-old ideas of Tsiolkovskiy. If Korolev had his way, by the end of the 1960s, there would be a proliferating Soviet space program spreading through the solar system from giant stations in Earth orbit. These plans, of course, never came to fruition. The architects of the Soviet space program finally began to take notice of an awakened giant, and its gaze was not at Mars, but directed toward the Moon.

Designing for a New Generation

Plans for a new spacecraft to succeed the Vostok ship existed well before Gagarin's historic launch. In 1958 and 1959, engineers at OKB-I considered various mission objectives of such a vehicle before settling on two primary goals that dominated the thinking on piloted spacecraft for the ensuing half decade: circumlunar flight to the Moon and the mastering of rendezvous and docking that would eventually lead to the establishment of space stations in Earth orbit. The Moon itself figured prominently in OKB-I's plans for automatic research, but in the context of piloted exploration, it remained essentially a component of the design bureau's ultimate plans to reach Mars. While the salient details on exactly why a circumlunar project was targeted remain

¹²⁰ S. P. Korolev, "Notes on Heavy Interplanetary Ships and Heavy Orbital Stations (1962)" (English title) in M. V. Keldysh, ed., *Tvorcheskoye naslediyе Akademika Sergeya Pavlovicha Koroleva: izbrannyye trudy i dokumenty* (Moscow: Nauka, 1980), pp. 450–56.

¹²¹ Golovanov, *Korolev*, p. 768. On several occasions, Korolev proposed the use of the TOS for military applications. In a letter to the then Chairman of the State Committee for Defense Technology K. N. Rudnev dated January 15, 1961, Korolev proposed launching the TOS into orbit to carry out military missions. A fifteen-part treatise on the TOS was prepared by OKB-I at the time. See S. P. Korolev, "Letter to K. N. Rudnev on Planning Work at OKB-I in 1961–62" (English title) in Raushenbakh, ed., *S. P. Korolev i ego delo*, pp. 316–19, 621–23.

undisclosed, it is highly likely that the relative simplicity of such an effort was what attracted Korolev to begin work on this issue. In addition, cosmonauts successfully flying around the Moon would not only provide the space designers with valuable experience in a variety of technical areas, but would also be a tremendously exciting public relations extravaganza prior to more substantial missions to Mars. Rendezvous and docking on the other hand were considered logical extensions of Soviet plans to gain a permanent foothold in space. All of Tsiolkovskiy's early plans clearly hint at orbital assembly in Earth orbit as a starting point to move further into the cosmos. There was another more earthly reason for mastering rendezvous and docking: the lack of powerful enough launch vehicles to accomplish the ambitious goals of OKB-I. By 1961, the most powerful booster in the Soviet canon, the 8K78, could manage to send only a modest one and a half tons toward the Moon, while the 8K72K, which had launched Cagarin, could launch about just over four and a half tons into Earth orbit. With the larger N1 still years away from flight, orbital assembly was the only avenue for piloted lunar exploration.

These two considerations—circumlunar missions and orbital assembly—dominated the design of the first post-Vostok spacecraft. The choices and decisions engineers made from 1959 to 1963 based on these requirements had a profound impact on the shape and look of the Soyuz spacecraft as it eventually emerged in the late 1960s. Initially, the engineers studied at least two different spacecraft, both of which were geared to Earth orbit. Work on the first, the Sever ("North"), began in April 1959. Initial plans envisioned a large spacious vehicle with room for three cosmonauts dressed in spacesuits. A second proposal emerged from Pavel V. Tsybin, the man who had worked on the unfulfilled PKA spaceplane project. Tsybin's new idea encompassed a spacecraft capable of carrying seven cosmonauts, certainly a large leap from the modest Vostok.¹²² His proposal was apparently rejected very early in the design process, and by 1959 and 1960, engineers were harnessing their energies in the development of the Sever spacecraft, which became the focus of the second-generation Earth-orbital spacecraft. It was slated to fly its first mission by the second half of 1962.¹²³ A piloted spacecraft capable of lunar flight designated the "IL" was also studied concurrently, sharing numerous design characteristics with the Sever.

It was originally the famous Department No. 9 at OKB-I, with such luminaries as Tikhonravov and Feoktistov, that began studying the next generation of Soviet spacecraft. By 1960, it had issued a "scientific-technical prospectus" proving that rendezvous and docking in orbit were realistic goals achievable in the near future. Based on this premise, in 1960 and 1961, the department studied a number different variants of the Sever and IL ships, proposing that a circumlunar flight could be achieved by linking up several booster stages in Earth orbit to reach escape velocity in the direction of the Moon. By this time, the effort to a design new spaceship essentially took on a competitive character within OKB-I itself. Departments No. 9 and 11, headed by Tikhonravov and Vladimir F. Roshchin, respectively, proposed parallel design concepts of the new vehicle, while the development of lunar spacecraft as a whole was subordinated to Department No. 3 under Yakov P. Kolyako. This peculiar sort of competition in such a centralized command system was clearly contrary to all Western conceptions of the Soviet defense industry at the time. Most outside analysis attributed a simpler monolithic scientific infrastructure, which had no allowance for this almost Western notion of competitive ideas. The overall research was overseen by Deputy Chief Designers Bushuyev and Kryukov.

The two most important areas of research during the design of the Sever and IL spacecraft were the identification of an optimal reentry profile and the selection of the shape of the

122 Golovanov Korolev p 720 S S Kostin, "Some Aspects of Planning the Vostok Space Ship" (English title), *Iz istorii aviatsii i kosmonavtiki* 42 (1980) 62-66

123 Kamanin *Skrytyi kosmos* p 56 By May 1961 Korolev was planning the first Sever launch in the third quarter of 1962

spacecraft—factors that were clearly interdependent. In terms of the reentry and landing on Earth's surface, engineers considered two broad approaches: an aviation perspective using aerodynamic surfaces and a missile perspective using a ballistic reentry with landing by parachutes. Beginning in 1960, the engineers under Bushuyev's supervision at the various departments studied three specific variants of the reentry capsule of the new spacecraft:

- One with large wings such as an aircraft from Department No. 9 (called the "canard" scheme)
- One for a simple ballistic reentry such as the Vostok spacecraft
- A hybrid version with a blunt nosecone, such as NASA's Mercury capsule, but with wings (called the "tail-less" configuration)

Comparative analysis on the three different variants included studying their aerodynamic characteristics, types of trajectories, thermal protection, mass characteristics in relation to their chosen methods of landing, and the layout of instrumentation. By 1961, winged designs were abandoned, because of the attendant problems with mass and heat protection, in favor of guided or what the Soviets termed "glancing" reentries, which would allow significant reductions in stress as compared to direct ballistic profiles.

Having narrowed the possibilities down, Roshchin's department carried out more detailed analysis on reentry profiles with special regard to reentry at high speeds following a flight around the Moon. Because the spacecraft would return from the Moon, the engineers dispensed with a special orbital braking rocket such as the one used on Vostok, saving valuable mass on the ship. Instead, they settled on a profile that called for a "double-dip" into the atmosphere to reduce both velocity and gravitational loads on the crew. In the first stage, the return capsule would graze off the upper atmosphere before entering again, by which time, the g-loads would have decreased significantly. The requirements showed that the spacecraft would have to have sufficient lift characteristics to allow the "double-dip" profile as well as permit a landing on Soviet soil following a travel down a 3,000- to 7,000-kilometer-long corridor from the south to the north of the planet. Gravitational loads would be limited to three to four g's, while landing could be achieved with a plus/minus fifty-kilometer error.

For obvious reasons, the concerns over reentry profiles significantly affected the decisions over the shape of the reentry capsule. Apart from engineers within OKB-1, scientists at other institutions, including NII-1, the Central Aerohydrodynamics Institute, and NII-88, were involved in this stage of research. They examined three different configurations:

- A so-called "segmented sphere"
- A "sphere with a needle"
- A "sliced sphere"

Once again, the investigations focused on a comparative analysis of aerodynamic characteristics, determinations of optimal return trajectories, the selection of the structure itself, and requirements for thermal protection. The results of the research proved that from a technical perspective, the most rational choice from the criteria of mass and volume was Department No. 11's segmented sphere with a displaced center of gravity in the transverse direction. By 1962, Roshchin's group had modified this idea into an asymmetrical segmented sphere, similar in shape to an automobile headlight, in which the length of the capsule was equal to the base diameter. Computations showed that such a design would increase lift during reentry, thus avoiding the pitfalls of direct ballistic return into the atmosphere. The Scientific-Technical Council of the OKB-1 rejected a competitive variant from Department No. 9 of a

semi-spherical capsule, and after approval by Korolev and Bushuyev, the "headlight" idea was adopted formally for the Sever spacecraft by 1962.

Yet another important issue was the means of landing on Soviet soil. Water landings were apparently not considered at all, and all research focused on hard landings on Soviet soil. A plethora of proposals crowded the research on this issue, so much so that even after a final decision on the landing was made in 1963, research on alternative versions continued up until 1966, a full five years after this work had begun. Korolev himself was apparently reluctant to continue using parachutes and instead tried to explore much more unusual approaches, as evidenced by his interest in helicopter-type landings for the Vostok spacecraft. Numerous organizations were involved in this stage of the research, including OKB-329 (on a subsonic rotor system), the Mozhayskiy Academy (hypersonic rotors), OKB-300 (fanjet engines), OKB-2 (liquid-propellant rocket engines), Plant No. 81 (solid-propellant rocket engines), NII PDS (controlled parachutes), Plant No. 918 (an ejection system as a reserve method), and NII RP (external inflatable shock-absorbing balloons). OKB-1 itself studied the use of turbojet engines. The proposals from all these organizations, to a great degree, affected the design of the spacecraft itself, and it was not until 1963 that Korolev approved the recommendation of Department No. 11 to use a combination parachute-reactive system with solid-propellant engines. The return capsule would deploy a series of parachutes during descent, followed by the firing of powerful solid-propellant rocket engines a few seconds prior to contact with the ground to lessen the shock of impact.

The issue of rendezvous and docking in space, critical to any mission goals foreseen for the near future, was the subject of intensive research at Department No. 27 headed by Boris V. Raushenbakh, designer of the first Soviet space orientation systems. The overall work was supervised by Deputy Chief Designer Boris Ye. Chertok, one of the most senior veterans at OKB-1. The research, conducted between 1960 and 1963, divided the rendezvous phase of two Earth-orbiting spacecraft into two components: the long-range and the close-range portions. The former would depend to a great extent on putting the spacecraft into an optimal trajectory at orbit insertion, based on composite ground measurements and computational models. Ground stations would compensate for errors by sending appropriate commands to the orbiting ship to perform the required orbital changes to bring the active spacecraft to its target. Theoretical calculations by engineers showed that with the existing systems, the two spacecraft could be brought within a twenty five- by fifteen- by fifteen-kilometer volume in space with a relative velocity of plus or minus forty meters per second.

For Raushenbakh's group, the more problematic portion of the rendezvous maneuver was the close-range approach. The "free trajectory" from launch was clearly not sufficient to allow two spacecraft to dock. In addition, ground measurements would not distinguish two vehicles at such high altitudes to ensure the required precision. Shipboard measurements were also ruled out because of the need for the presence of powerful and compact computing machines aboard the spacecraft, which were simply beyond the limits of Soviet miniaturization technology for the time. Raushenbakh's team developed a combination system using the so-called "parallel approach," in which a line of sight extending from the active to the passive spacecraft would be established for movement. A special on-board radar would then take over control of the spacecraft to bring the two spacecraft to docking. Four different institutions offered competitive proposals to design and build the radars. The two finalists were the Experimental Design Bureau of the Moscow Power Institute and NII-648. After detailed analysis, the former's *Kontakt* ("Contact") was rejected in favor of the latter's *Igla* ("Needle") in 1963. Raushenbakh's group at OKB-1 developed the algorithms for the logic command instruments for the entire rendezvous and docking procedure.¹²⁴

124 Semenov ed *Rakety Kosmicheskaya Korporatsiya* pp 162-65 The other two competitors in radar design were TsNII 108 whose design was too heavy and TsKB Geofizika which proposed a laser optical system See B Ye Chertok *Rakety i lyudi goryachiye dni kholodnoy voyny* (Moscow Mashinostroyeniye 1997) pp 395-96

Korolev's engineers finalized the configurations for both the Sever and IL spacecraft by early 1962. The Sever, slated only for Earth-orbital operations, was much larger than the Vostok spacecraft, although it, like the Vostok, was divided into two main sections: a cylindrical instrument module and a headlight-shaped return capsule attached at the forward end of the spacecraft." The former would carry all the guidance and control systems, propulsion units, power sources, and propellant tanks. The latter would carry the crew and be equipped with life support systems and controls for the crew to guide the spacecraft. The IL spacecraft, meant for lunar missions, had a more complicated configuration, prompted by the concerns of engineers who wanted to ensure comfortable conditions for a crew during a potentially weeklong circum-lunar mission. As early as 1960, Department No. 11 had proposed the addition of adding a third pressurized module to the spacecraft, called the orbital module, which would allow cosmonauts more volume than the cramped quarters of the return capsule. A competitive proposal from Department No. 9 retained the old two-module configuration, with the crew remaining in the return capsule for the duration of the mission. Like many of the latter department's proposals, this conservative arrangement was rejected in favor of Department No. 11's idea to use a third module.

The placement of the new module as part of the IL spacecraft was the subject of much debate. Initial conceptions showed the return capsule at the top of the spacecraft, followed by the new orbital module below it between the other two compartments. The crew would be able to open a hatch in the heat shield at the base of the return capsule to move into the orbital module. The instrument module would remain at the base of the spacecraft and would not be accessible to the crew. Tests at the time proved that having a hatch in the heat shield was not an optimal arrangement and raised all sorts of potential dangers for burn-through during reentry. The engineers eventually adopted a novel arrangement, with the orbital module at the very forward end of the spacecraft. A hatch at the apex of the return capsule would allow the crew to move *forward* into the cylindrical orbital module.²⁶

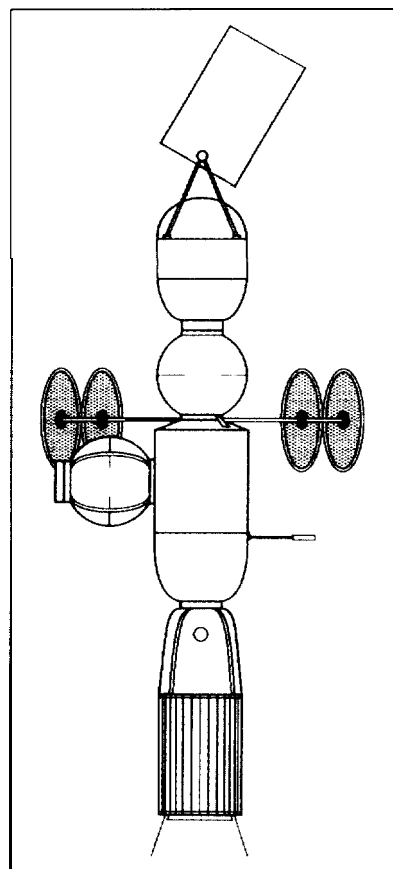

This is one conception of an early Earth orbital station dating from 1962. A visiting spacecraft called the Sever is shown docked to the station at the bottom of the drawing. The design of the Sever eventually evolved into the future Soyuz spacecraft (copyright R. F. Gibbons based on a drawing by Igor Afanasyev)

125 The Sever has not been described in any detail in any Russian sources. The above description is based on a drawing published in Afanasyev, "Unknown Spacecraft."

126 There has been some speculation that the three-module design adopted for the IL spacecraft was appropriated by OKB-1 engineers from a publicly available study by U.S. defense contractor General Electric. During 1960, NASA, in planning for a post-Mercury spacecraft, had asked for proposals from several major aerospace companies. The concept submitted by General Electric on October 9, 1960, had a similar configuration to the IL, in particular with relation to the placement of the reentry module between the "mission module" and the "propulsion module." See P. S. Clark and R. F. Gibbons, "The Evolution of the Soyuz Programme," *The Journal of the British Interplanetary Society* 36 (1983) 434-52.

This is the design of the Vostok 7/11 complex for a piloted circumlunar spacecraft. The legend is (1) forward section of the IL spacecraft (2) IL living compartment (3) IL descent apparatus (4) solar panel (5) IL instrument compartment (6, 7 and 8) three "rocket block" propulsion modules (9) jettisonable section of the final rocket stage, and (10) Vostok 7 spacecraft. (copyright Igor Afanasyev)

The IL design was also distinguished from the Sever spacecraft in terms of several other aspects. The Instrument module was shaped like a cylindrical skirt, with two disk-shaped solar panels attached at the end of two booms to provide power—a first for a Soviet piloted spacecraft. This instrument module was also equipped not only with a propulsion system, but also a docking system at the aft of the spacecraft. The return capsule itself harked back to early conceptions of segmented spheres and was shaped more like a cylinder than the later "automobile headlight" design adopted for the Sever. By 1962, when engineers finalized the design of the IL spacecraft design, it had four separate sections from aft to fore:

- A cylindrical skirt-shaped instrument-aggregate compartment
- A segmented spherical descent apparatus
- A cylindrical living compartment
- A conical nose propulsion system"

The nose propulsion system was simply a small compartment at the forward end of the spacecraft for carrying out attitude control during rendezvous and docking in Earth orbit.

Elements of both the Sever and the IL spacecraft would eventually serve as the basis for the development of the famous Soyuz spacecraft, certainly the most important piloted spacecraft of the Soviet space program. The final variants of both the IL and the Sever, as well as of the still-flying Vostok spacecraft, were part of an idea proposed by Korolev on January 26, 1962, for a four-module fifteen- to twenty-five-ton "space train" ensuring circumlunar flight." The first results of the research on this theme were summarized in a "scientific-technical prospectus" titled "Complex for the Assembly of Space Vehicles in Artificial Earth Satellite

127 Afanasyev. "Unknown Spacecraft."

128 Lardier. *L'Astronautique Sovretique*. p. 155

Orbit," which was signed by Korolev on March 10, 1962." The project as a whole was designated Soyuz, the Russian word for "union." There were three different goals of the complex:

- The creation of an orbital piloted station for military missions
- The creation of piloted spaceships capable of circumlunar missions
- The creation of a global communications satellite system

A nominal circumlunar mission would be achieved by assembling a series of rocket stages in Earth orbit into a multistage rocket that would boost the payload toward the Moon. The four major components of the complex were:

- A modified Vostok spacecraft designated the Vostok-7
- A "rocket block." three of which would be launched
- A jettisonable toroidal compartment attached to the base of each rocket block containing rendezvous and docking instrumentation
- The primary payload, a 1L spacecraft

The Vostok-7 was a modified Vostok-3A spacecraft that had launched Gagarin. In contrast to Gagarin's spacecraft, the "new" vehicle would include rendezvous and docking gear, a multi-use primary propulsion system capable of orbital changes, and attitude control engines." While these changes would increase mass by 1,100 to 1,300 kilograms. in all other respects, the spacecraft was similar in design configuration to the old Vostok-3A vehicle. The rocket blocks, 4,800 kilograms each, were simply short cylindrical modules capable of independent flight and equipped with engines for work in vacuum." The Vostok-7 spacecraft, the rocket blocks, the 1L vehicle, and the Sever spaceship would all be launched into orbit by means of improved versions of the old 8K72K booster equipped with a more powerful third stage."

A mission to perfect rendezvous and docking techniques would start with the launch of a Vostok-7 spacecraft with a single cosmonaut, designated a "pilot-assembler." At a designated

129. Afanasyev. "Unknown Spacecraft." This document, in a censored version and with a different title, has been published as S. P. Korolev, "Proposal for the Creation of Means for Orbital Assembly" (English title). In Keldysh, ed., *Tvorcheskoye naslediyе Akademika*, pp. 445-49. Note that Korolev sent a letter to the Military-Industrial Commission, dated March 5, 1962, requesting permission to develop this complex; he enumerated several military goals for the system, including reconnaissance and anti-satellite operations. An abridged version of this letter has been reproduced as S. P. Korolev, "Proposal for Complex for the Assembly of Space Apparatus in an Earth Satellite Orbit (Theme 'Soyuz')" (English title), in Raushenbakh, ed., *S. P. Korolev i ego delo*, pp. 359-60.

130. The Vostok-7 would include the following systems in addition to the ones already existing on the Vostok-3A (1) apparatus for controlling rendezvous as part of the orientation and control system, (2) apparatus for search and targeting, (3) on-board radio systems; (4) the coordination engine system with eight engines and a reserve of propellant, (5) optical systems for observing rendezvous and docking, (6) a docking node with mechanical locks and electrical connections; (7) apparatus to control mechanical and electrical connections, (8) and additional power sources. The following systems would be modified from those on the original Vostok-3A: (1) orientation and control systems; (2) the cosmonaut's control panel; (3) the TV system; (4) the Zarya communications system, and (5) the retrorocket engine. See Korolev, "Proposal for the Creation of Means for Orbital Assembly"

131. Each rocket block would have the following systems (1) engines, (2) armature for firing, controlling, and shutting down the engines; (3) propellant tanks, (4) systems for ensuring proper propellant flow; (5) guidance systems, and (6) mechanical systems for connecting with other spacecraft. The jettisonable portion of each rocket block would include: (1) systems for coordinating the engines; (2) orientation systems; (3) systems for measuring orbital parameters; (4) communications systems; (5) systems for search and targeting; (6) communications systems for work with other space ships; (7) TV cameras, (8) lights for optical signals to other ships, (9) the Signal telemetry system; (10) docking nodes; (11) apparatus for controlling mechanical and electrical connections between the ships, (12) thermo-regulation systems for the propellants, and (13) power sources

132. This booster was the 8K711.

time when the spacecraft would pass over the launch site, the first rocket block would be launched into a similar orbit. The pilot would then switch on the automatic system of approach, which would bring the Vostok-7 spacecraft to a distance of about five to ten kilometers from the rocket block. The second stage of rendezvous with the aid of radars would decrease the distance to 100 to 200 meters. After docking by manual control, the pilot would establish electrical and mechanical connections between the two vehicles, now with a total mass of eleven to twelve tons. The jettisonable toroidal section of the rocket block would then separate and be discarded, revealing a docking node on the opposite end of the cylinder-shaped block. The mission would continue with further launches of at least two more rocket blocks which would connect to the complex, creating a four-vehicle "space station." After performing some military experiments, the Vostok-7 spacecraft would separate from the first rocket block of the complex and return to Earth.

In the case of a circumlunar mission, a fifth vehicle, the IL, would be launched with a crew of one to three cosmonauts and perform a docking at the end of the final rocket block by literally backing into the complex. At this point, the Vostok-7 spacecraft, its job done, would undock from the complex and return to Earth. The remaining rocket stages would fire one by one, gaining sufficient velocity to boost the IL spacecraft and its crew on a simple circumlunar mission.

The prospectus also described the launch of large 1,100- to 1,200-kilogram communications satellites into geostationary orbit by means of the three similar rocket stages and the Vostok-7 spacecraft. In such a mission profile, the satellite would replace the IL as the primary payload of the complex. Another mission mode proposed in the same document was the creation of a small piloted orbital station crewed by three cosmonauts. The station itself would consist of two units: a "living section" and a science-package unit. Four large disk-shaped solar panels on two booms would provide on-board power. The crew would travel to and from the station by means of the Sever spacecraft, equipped with the headlight-shaped guided reentry vehicle. The primary objective of such a station was apparently Earth observation, presumably for military purposes. A final mission for the complex would be in conjunction with the 5KM piloted military "space fighter."

Among the multitude of goals planned for the Vostok-7 complex, possibly the most important for Korolev was the piloted circumlunar mission, which had become somewhat of a priority among Soviet space organizations at the time. General Designer Chelomey's OKB-52 was also exploring such missions with its own resources during the same period. Furthermore, in 1962, Academician Keldysh's "brain center," at the Department of Applied Mathematics of the V. A. Steklov Mathematics Institute of the Academy of Sciences, had just completed a detailed mathematical study on the technical aspects of a piloted circumlunar mission with a particular focus on having the return capsule land on Soviet territory." In documents dating back to January 1962, Korolev was already requesting the manufacture of eight Vostok-7 spacecraft specifically for the circumlunar mission, most likely set for the 1963-64 timeframe."

The high priority on the accomplishment of a circumlunar mission as early as possible resulted in many of the odd design elements of the Vostok-711L plan. Because there would be no heavy booster to carry out a single mission profile, Korolev opted instead to carry out a multitude of dockings in Earth orbit. The use of the Vostok spacecraft for such an ambitious

133 Afanasyev "Unknown Spacecraft" Korolev "Proposal for the Creation of Means for Orbital Assembly"

134 This report has been published as M V Keldysh M L Lidov A M Mikish and G I Taratynov "Flight Around the Moon With a Return to Earth and Landing on the Territory of the Soviet Union" (English title) in V S Avduyevskiy and T M Eneyev eds M V Keldysh *izbrannyye trudy raketnaya tekhnika i kosmonavtika* (Moscow Nauka 1988) pp 422-57

135 Kamanin *Skrytiy kosmos* p 88

mission, despite research on a next generation of spacecraft, was clear indication that the plan was somewhat of a hasty idea. Korolev, in fact, at one point even explored the possibility of using solid-propellant rocket engines, five of them, as propulsion for the rocket stages, but he was talked out of this idea by the combined persuasive efforts of Kryukov, the nominal head of the design project, and design engineer Feoktistov.¹³⁶

Regardless of the merits of the plan, a month after the Vostok-7/1L technical prospectus was issued, on April 16, 1962, the Soviet Communist Party and the government signed a decree on Korolev's Soyuz theme, apparently prompted by its military applications.¹³⁷ Quite possibly, the circumlunar nature of the project was an added bonus for the leadership. The timing of the decree was clearly an anomaly; it was issued during a period when Chelomey was the dominant figure in the space program, and Korolev's star had dropped to its literal nadir. Judging by the subsequent events, it seems that the decree had little effect. Like much of Korolev's efforts during this period, the Party and government failed to back up a commitment with actual action. Despite the ambivalent repercussions of the decree, there was a marked shift in Korolev's strategy of piloted space exploration around the early summer of 1962. The complicated Vostok-7/1L plan was put back on drawing boards for major changes in its weak points, especially the use of the Vostok spacecraft as part of a circumlunar mission. In addition, perhaps to focus limited resources on the circumlunar plan, the center of Korolev's Earth-orbital plans, the innovative Sever spacecraft, was completely abandoned. The experience in designing both the Sever and the 1L did, however, have a lasting influence on the shape of a famous Soviet spacecraft of the future.

The Soyuz

The redirection of OKB-1 plans in mid-1962 resulted in at least one positive outcome: the development of a more optimal second-generation spacecraft, much more advanced than the Vostok-7. By taking elements from the 1L and the Sever spaceships, by late 1962, engineers at the design bureau emerged with a new spacecraft, simply called the Soyuz or "the product 7K," which would become the basis of Soviet piloted space exploration for the next thirty years. The engineers retained the three-module configuration of the 1L, but they adopted the headlight-shaped return capsule and the cylindrical instrument module from the Sever. A significant alteration from both the 1L and the Sever was the marked decrease in the size of the return capsule. Originally, Department No. 11 had adopted a capsule with a diameter of 2.2 meters (2.3 meters, including the thermal protection), but to decrease the overall mass of the spacecraft, Feoktistov proposed reducing the dimension down to two meters, thus creating very cramped conditions within the module. Upon being told of this proposal at a meeting, the unconvinced Korolev marked off an area in his office the size of the capsule and ordered one of the authors of the idea to spend the remaining time of the meeting in the area. Despite the discomfort, the engineer continued to pursue the idea. Korolev finally caved in, and by late 1962, the size of the return capsule on the 7K/Soyuz was reduced to two meters. In retrospect, this decision proved to be "irrational" when, by 1968, an extra 200 kilograms had been shaved off the mass of the spacecraft, thus no longer requiring the smaller dimension. But by that time, it was too late. The cosmonauts would have to endure the launch in relatively cramped conditions.¹³⁸

136. Golovanov, *Korolev*, pp. 720-21.

137. Semenov, ed., *Raketno-Kosmicheskaya Korporatsiya*, p. 635. Note that this source says that the title of decree was "On the Development of the 'Soyuz' Complex for Piloted Flight Around the Moon." This is probably an error. See also Raushenbakh, ed., *S. P. Korolev i ego delo*, p. 685.

138. Ishlinskiy, ed., *Akademik S. P. Korolev*, p. 96; Semenov, ed., *Raketno-Kosmicheskaya Korporatsiya*, p. 170.

The use of multiple rendezvous and docking as part of a circumlunar mission was not abandoned, despite reservations from key engineers at OKB-1. One particularly insistent opponent of the plan was Deputy Chief Designer Leonid A. Voskresenskiy, one of Korolev's most trusted aides who had worked with him since World War II. Although he did not have any formal higher education, Voskresenskiy had earned his reputation by a seat-of-the-pants decision-making and a remarkable intuitive capability, which had allowed him to earn the respect of OKB-1 engineers. The deputy was simply against the idea of conducting four dockings in Earth orbit, rightly seeing in the profile immense possibilities for failure. The design bureau had begun the development of a complex docking system only in the summer of 1962, but the two engineers leading the project, Viktor P. Legostayev and Vladimir S. Syromyatnikov, ran into significant obstacles. As Syromyatnikov recalled:

The Chief Designer was not satisfied either with the organization of the work, nor with its results. The designs turned out to be cumbersome, complex to control, and contained many separate mechanisms. Significant simplification and greater compactness was required. Only by the spring of 1963 did the outline of the future design for the docking assembly become clear: a moving pintle on an active spacecraft and an acceptor cone on the passive one."

The delays in the development of a docking system, as well as the attendant obstacles of designing rendezvous systems, did not deter Korolev from adopting yet another multiple docking plan for his coveted circumlunar mission. A "new" plan involving the two-person 7K/Soyuz spacecraft, the 9K translunar injection rocket stage, and the 11K propellant tanker was finalized in a preliminary draft plan signed by Korolev on December 24, 1962, only months after the abandonment of the earlier Vostok-7/1L multiple docking scheme.¹⁴⁰ Over opposition from some of his deputies, the final technical draft plan for the 7K/Soyuz spacecraft itself was signed by Korolev on March 7, 1963, thus committing OKB-1 to forge ahead with the development of the ship as the center of its immediate goals of human spaceflight.

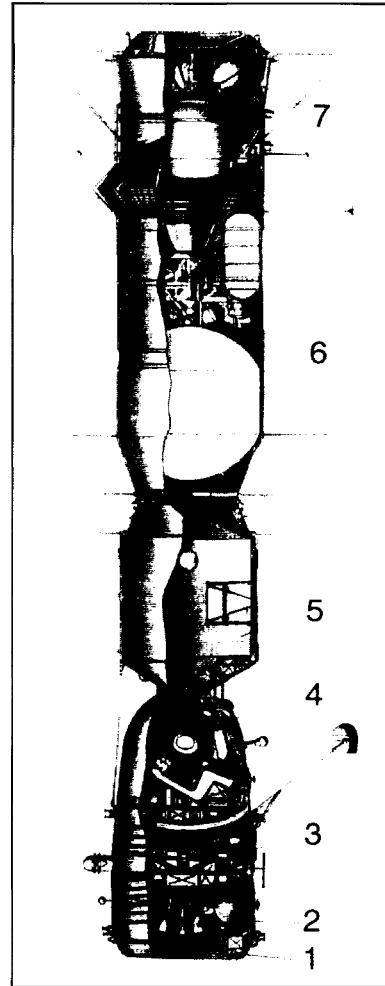

The 7K-9K-11K piloted circumlunar complex emerged in 1963 as a successor to the Vostok 7/11 conception. The image here shows the 7K spacecraft docked to the 9K translunar injection stage, which has been loaded with propellant by means of several 11K orbital tankers. The legend is (1) and (7) jettisonable compartments; (2) 7K aggregate compartment; (3) 7K instrument compartment; (4) 7K descent apparatus; (5) 7K living compartment; and (6) 9K rocket block. Note the close resemblance of the 7K to the future Soyuz spacecraft (reproduced from M. V. Keldysh, ed. *Tvorcheskoye naslediye Akademika Sergeya Pavlovicha Koroleva izbrannyye trudy i dokumenty* (Moscow: Nauka, 1980).)

¹³⁹ Ishlinskiy, ed. *Akademik S. P. Korolev*, p. 231. Authors' emphasis. The author of the "pin needle" docking mechanism was OKB-1 engineer L. B. Vilnitskiy.

¹⁴⁰ Semenov, ed. *Raketno-Kosmicheskaya Korporatsiya*, p. 163.

These internal design bureau deliberations in favor of the multiple docking circumlunar plan were aided to a large degree by external shows of support. The Interdepartmental Scientific-Technical Council on Space Research, the interagency forum composed of the most important chief designers, academicians, and military officers of the space program, for the first time addressed Korolev's 7K/Soyuz spacecraft proposal at a meeting in early December 1962. Under the direction of Academician Keldysh, the council recommended the creation of an "expert commission" to examine the salient details of the program." This commission, with four subsections representing interests other than OKB-1, was able to suggest amendments to the technical design of the space complex during the ensuing few weeks.¹⁴² A second meeting of the council was held on March 20, 1963, once again presided by Keldysh to decide on the project, based on the expert commission's recommendations. Among those in attendance were Chelomey and Glushko, both erstwhile opponents of Korolev's own plans for space exploration.¹⁴³ In his speech at this meeting, Korolev expounded on the primary goals of the Soyuz project, mentioning both rendezvous and docking as well as piloted circumlunar missions. Keldysh, Chelomey, and Glushko spoke after Korolev and made approving comments on the proposal; not surprisingly, Chelomey and Glushko had some additional comments on the potential "of great difficulties in its realization." Despite their words of caution, Korolev had sufficient support to obtain the full-fledged approval of the project, optimistically projecting the first test flight of the 7K/Soyuz spacecraft by the summer of 1964.

The council's unanimous decision in favor of Soyuz was, of course, not binding because neither the Communist Party nor the government had issued a document in support of the new proposal. The recommendation did, however, have the effect of shoring up Korolev's relatively weak position in the space industry at the time. With continuing troubles with the N1, Korolev pinned his hopes at regaining a flash of his glory days on the Soyuz project. Less than two months after the council's meeting, on May 10, 1963, OKB-1 issued a new "technical prospectus" titled "Assembly of Space Vehicles in Earth Satellite Orbit," which described in detail the 7K-9K-11K, or the Soyuz complex, which was to take the first Soviet cosmonauts around the Moon."¹⁴⁴

The center of these plans was the 7K or Soyuz spacecraft, a 7.7-meter-long three-module vehicle designed by meshing together the 1L and the Sever ships. The three primary components from aft to fore were:

- The cylindrical instrument-aggregate compartment
- The headlight-shaped descent apparatus
- The cylindrical living compartment

141 Kamanin, *Skrytiy kosmos*, pp. 191-92. Among those present at the meeting on December 6, 1962, were S. P. Korolev (OKB-1), V. N. Chelomey (OKB-52), M. K. Yangel (OKB-586), A. F. Bogomolov (OKB MEI), V. I. Kuznetsov (NII-944), M. V. Keldysh (AN SSSR), A. Yu. Ishlinskiy (NII-944), N. M. Sisakyan (AN SSSR), A. A. Blagonravov (AN SSSR), A. I. Sokolov (RVSN), K. A. Kerimov (RVSN), N. P. Karnanin (VVS), and N. N. Alekseyev (MO NTK).

142 One of the subsections was from the Air Force, which recommended three changes to the Soyuz spacecraft: the use of spacesuits at all times for cosmonauts, the use of wings to provide aerodynamic lift; and the use of catapults for launch escape. None of them were accepted by OKB-1. See *ibid.*, p. 211.

143. *Ibid.*, pp. 239-40. Among those present were M. V. Keldysh (AN SSSR), S. P. Korolev (OKB-1), V. N. Chelomey (OKB-52), A. Yu. Ishlinskiy (NII-944), V. P. Clushko (OKB-456), A. A. Kobzarev (CKAT), G. I. Voronin (OKB-124), N. S. Stroyev (LII), N. P. Karnanin (VVS), M. P. Odintsov (TsPK), V. I. Yazdovskiy (CNII AikM), Ye. A. Karpov (TsKP), Yu. A. Cagarin (TsPK), G. S. Titov (TsPK), A. I. Sokolov (NII-4), and N. N. Yuryshv (RVSN).

144. Afanasyev, "Unknown Spacecraft." The document has been reproduced with censored designations as S. P. Korolev, "The 'Soyuz' Orbital Rocket Complex" (English title), in Keldysh, ed. *Tuorcheskoye naslediyе Akademtka*, pp. 489-500.

The instrument-aggregate compartment had four components analogous to successive "slices" down the cylinder, none of which would permit access by crewmembers. These sub-compartments were from aft to fore:

- The jettisonable orbital compartment in the form of a torus at the base of the spacecraft, which contained rendezvous instrumentation, radio systems to control its orbit, apparatus for transmitting guidance commands, thermo-regulation systems, automatic guidance systems, and tracking systems
- The aggregate compartment, which carried the primary "approach-correction" engines of the 7K vehicle, as well as attached solar batteries to serve as power sources
- The instrument compartment, the largest section of the cylinder, which contained the essential instrumentation of the vehicle to ensure extended flight in space, including long-range radio apparatus, orientation and attitude control systems, radio-telemetric systems, primary thermo-regulation systems, power sources for the ship, programmable timer devices, on-board switching systems for controlling the automatic guidance systems, and sensors and "switchboard-relay apparatus" for tracking
- The transfer compartment, which contained the attitude control engines on the exterior and their propellant tanks in the interior

The descent apparatus was merely a smaller version of the headlight on the Sever, with life support systems, thermo-regulation systems, optical and TV systems for observation and guidance, control panels for the crew, radio communications systems, systems to guide the capsule in the atmosphere, and a parachute system for landing on Earth. Thermal protection at the base of the capsule would provide sufficient defense during high-speed reentry from lunar distances. The living compartment was the additional cylindrical module, with approximately the same diameter as the instrument-aggregate compartment, a little more than two meters. This section would contain life support systems, elements of the thermo-regulation system, microphones and "dynamic" systems of communications, scientific instruments, and movie cameras. The cosmonauts could also use the compartment as an airlock for extravehicular activity. In addition, the apex of the living compartment, and thus the whole spaceship, would have a large docking system for linking up with other spacecraft. The total mass of the 7K/Soyuz ship was 5,500 to 5,800 kilograms.

The single rocket stage, designated the 9K, was designed to accelerate the 7K/Soyuz vehicle on a translunar trajectory. The 7.8-meter-long spaceship was shaped like a simple cylinder divided into two primary sections, the large 9KM rocket block and the smaller 9KN jettisonable compartment. The latter contained an orbit correction engine, control systems, and rendezvous instrumentation, as well as a docking node on one side, which would allow the transfer of propellants from the tankers. The former carried the main translunar rocket engine with a thrust of four and a half tons, as well as more instrumentation and a second docking node on the opposite end of the spacecraft. Launch mass was 5,700 kilograms.

The final element of the complex was the 4.2-meter-long cylindrical tanker named the 11K. It had two major compartments, the 11KA for the oxidizer and the 11KB for the fuel. The remaining portion of the spacecraft consisted of attitude control engines, electronic instrumentation for guidance, and a docking node. The total fueled mass was 6,100 kilograms. All the three components, the 7K, the 9K, and the 11K, would be launched by new three-stage versions of the R-7, designated the 11A55 and 11A56.

The primary mission of the Soyuz complex, a piloted circumlunar mission, would begin with the launch of the 9K rocket stage. The automated spacecraft would carry out the necessary changes to its orbit by means of its small orbit correction engine until it had reached the

desired orbital parameters. When the 9K passed over Tyura-Tam, the first IIK tanker would be launched into orbit carrying 4.155 kilograms of extra propellant. The initial orbital trajectory would posit the tanker within twenty kilometers of the 9K rocket block. If because of errors in orbital insertion the IIK module did not approach its parry to within a twenty-kilometer range, then the 9K block would carry out the necessary orbital adjustments to bring the two spacecraft within twenty kilometers. Automatic radars on both spacecraft would then complete the final approach, and the 9K (active vehicle) would dock with the IIK (passive vehicle). The docking would be carried out on the aft end of the 9K (with the jettisonable compartment). After the transfer of propellants through linked lines across the docking node, the IIK tanker would separate and be discarded.

At least three more tankers would be launched until the 9K was fully loaded with twenty-five tons of propellant. At this point, the 7K/Soyuz piloted ship would launch into orbit with its crew of two to three cosmonauts. The crew could either try manual or automatic docking; unlike the tankers, the 7K/Soyuz would dock on the 9K rocket stage's forward end. The jettisonable compartment on the 9K would continue to carry out necessary orbital maneuvers following docking. This compartment would then be discarded, finally revealing the powerful main engine of the 9K rocket block, which would then fire to boost the 7K/Soyuz, rear end first, toward the Moon. The 7K/Soyuz propulsion system itself would be used for trajectory corrections during flight to and from the Moon. After return to the vicinity of Earth, the 7K/Soyuz spacecraft would separate into its three component modules, with the descent apparatus making a controlled descent into the atmosphere, landing by parachute on Soviet territory.¹⁴⁵

Mastering rendezvous and docking operations in Earth orbit may have been one of the primary objectives of the Soyuz complex, but the incorporation of five consecutive dockings in Earth orbit to carry out a circumlunar mission was purely because of a lack of rocket-lifting power in the Soviet space program. The May 1963 document on the Soyuz complex thus emerged less as a technical exercise than from an inclination to promote a space project before the advent of the NI. It was a risky gamble—and one that evidently had the support of most of the major players in the space program, as evidenced by the interdepartmental Council's unanimous approval two months earlier. Contracts for the Soyuz complex were also handed out in 1963. In a move motivated by limited resources at OKB-1, Korolev signed agreements with two relatively new organizations that until then had zero involvement in the piloted space business. Both of them were led by proteges of Korolev: SKB-385 at Miass under Chief Designer Viktor P. Makeyev to produce the important 9K acceleration block and OKB-10 at Krasnoyarsk-26 under Chief Designer Mikhail F. Reshetnev to build the IIK tanker." Both Makeyev and Reshetnev had been key engineers at OKB-1 in the 1950s, rising to senior positions in management before being sent by Korolev to head independent organizations focusing on naval missiles and automated spacecraft, respectively.

The agreements of Korolev with Makeyev and Reshetnev were symptomatic of the remarkable decentralization of the Soviet space industry that had taken place between 1960 and 1963. At that point, no longer only competing with the Americans, Soviet space designers found themselves in battles among themselves, with institutions rising and falling with the tides of political favoritism. Chelomey's dramatic entrance and support from Khrushchev had clearly put him in a much more powerful position than Korolev, but there was still one important factor on which Korolev could count within the confines of the Soviet defense industry, and that

¹⁴⁵ Korolev "The 'Soyuz' Orbital Rocket Complex" Afanasyev "Unknown Spacecraft "

¹⁴⁶ Colovanov, Korolev pp 721-22 Other sources claim that both the 9K and IIK modules were to be manufactured at the Progress Plant in Kuybyshev

was prestige. It was, after all, he who had launched Sputnik and then Gagarin. The Soyuz complex was partly an attempt to maintain that prestige in the near future, while the NI would take care of it in distant years. For the present time, in 1962 and 1963, Korolev's ace in the hole was still Vostok, and it was with the Vostok spacecraft that the Soviet space program continued to accrue its accolades from a vast and unsuspecting public all over the world.



CHAPTER NINE SPACE POLITICS

The Soviet space program was neither a high priority nor a central tool of Soviet state policy. The spectacular achievements of the late 1950s and early 1960s were pushed by the chief designers, grudgingly approved by the Communist Party and government, and then used as propaganda vehicles by Soviet leaders for selling the virtues of the socialist system. Thus, while Communist Party functionaries eagerly extracted maximum political mileage from the Sputnik, Luna, and Vostok missions post *facto*, the political utility of these launches did not figure significantly into the original formulation of the flights. On the odd occasions when political considerations did enter into the equation, they were also instigated not by higher-ups in the decision chain, but rather the middle men involved in the space program. In the post-Gagarin period, many chief designers in fact offered up a variety of proposals to the leadership, all couched in terms of advancing the Soviet image across the world. One immediate example of such behavior was the launch of the first woman into space in 1963. Another was competing with the United States in the "race to the Moon." Both had little to do with a rational program of space exploration—and even less to do with scientific research. But both were symptomatic of the chaotic nature of the Soviet piloted space program during the 1960s.

Twins in Space

Because the Vostok program did not have any formal long-range program of missions, Soviet space officials planned flights based purely on the number of such vehicles that were rolling off OKB-1's production plant in Kaliningrad. Immediately after Gagarin's flight, in May 1961, there were orders for eighteen Vostok-type spacecraft, half of which were for piloted flight and the remainder being the reconnaissance satellite version.¹ To a great degree, future plans for piloted missions depended on Korolev's unwritten rule that each mission be a significant advance over the previous one. Thus, the two identical suborbital flights of astronauts Shepard and Grissom in 1961 would have been unthinkable in Soviet mission planning. Based on this somewhat unsound premise, in September 1961, one month after Titov's flight, Korolev proposed a triple-spacecraft joint flight in November: three Vostok spacecraft, each with a single cosmonaut, would be launched on three successive days. The first pilot would conduct a three-day mission, while the two others would be in space for two to three days. There would be one day during the joint mission when all three spacecraft would simultaneously be in space.²

¹ N. P. Kamanin *Skrytiy kosmos kniga pervaya 1960–1963gg* (Moscow: Infortekst IF, 1995) p. 56

² *Ibid.* p. 60; Nikolay Kamanin, "Work in the First Two Years: Space Diary" (English title) *Prauda*, April 8, 1991, p. 2

Both Air Force representatives and the physicians in charge of biomedical preparations strongly opposed the plan. The latter were particularly concerned about unduly extending the duration of future missions after Titov's startlingly poor experience in August. By late October, after opposition from highly placed Air Force leaders, including Commander-in-Chief Vershinin, Korolev limited the plan to two simultaneous launches of Vostok spacecraft. This more modest proposal was motivated by the limitations of the Soviet tracking and rescue networks, which would have been put under significant strain for a triple-flight plan. On the matter of mission length, Korolev was less interested in compromise, and the issue remained unresolved with a month left to launch. The schedule was seriously interrupted in late October when the Soviet Party and government abruptly adopted a decision to focus all resources on the Zenit-2 reconnaissance satellite program instead of Vostok, clear evidence that the piloted space program was not only not a priority for decision makers, but in many ways was hindered by work on the reconnaissance effort. The crewed Vostok mission was delayed until January 1962 at the earliest.

The cosmonauts themselves were put on continuous training regimes, ready to be able to undertake a mission within one month of the final order. In October, six cosmonauts—Bykovskiy, Komarov, Nelyubov, Nikolayev, Popovich, and Shonin—were assigned to train for the dual mission. All of them conducted three-day training sessions in the new TDK-2 simulator delivered to the Cosmonaut Training Center at the time. The selection and training of cosmonauts took an interesting turn at the end of 1961—one that was primarily driven by political considerations. In the summer of 1961, Lt. General Nikolay Kamanin, the Air Force General Staff representative overseeing the cosmonaut group, somewhat abruptly emerged with the idea to send a woman into space on one of the following Vostok missions. He apparently attempted to get highly placed leaders, such as Korolev, Keldysh, and even USSR Minister of Defense Rodion Ya. Malinovskiy, interested in his idea, but they all were unanimously opposed to the proposal.³ On why the Soviet Union needed to send a woman into space, Kamanin wrote in his journal.

1. Women will definitely fly into space—thus it is better to begin training them for this kind of mission as soon as possible.
2. Under no *circumstances* should an American become the first woman in space—this would be an insult to the patriotic feelings of *Soviet* women.
3. The first Soviet cosmonaut will be as big an active advocate for *communism* as *Gagarin* and *Titov* turned out to be.⁴

Despite the high degree of opposition he faced, Kamanin did not drop the idea; he claimed that he took the matter directly to Khrushchev, who approved the plan. Whether indeed he did so continues to be a matter of debate, but clearly his lobbying produced results. On December 30, 1961, the Central Committee approved a plan to select sixty new cosmonauts for the Soviet space program, including five women.⁵ Although it seems that the plan to select the men was postponed indefinitely, physicians from the Air Force's Institute of Aviation and Space Medicine contacted aviation clubs from all over the country to prepare a master list of

3 Yaroslav Colovanov *Korolev fakty i mify* (Moscow Nauka 1994) p 689 Christian Lardier *L'Astronautique Soviétique* (Paris Armand Colin 1992) p 132 E mail correspondence Sergey Voevodin to the author January 30 1997

4 Kamanin *Skrytiy kosmos 1960-1963* p 62 Debra D Facktor and Valentina Ponomareva "Women in the Early Soviet Spaceflight Program" presented at a meeting of the American Association for the Advancement of Slavic Studies Boston MA November 14-17 1996 Bart Hendrickx "The Kamanin Diaries 1960-1963" *Journal of the British Interplanetary Society* 50 (January 1997) 33-40

5 Kamanin *Skrytiy kosmos 1960-1963* pp 238-39

400 women candidates. Women with significant aviation or parachuting experience were given preference over others, the latter qualification being especially important for ejecting from the Vostok capsule after reentry. Having cut the list down to fifty-eight candidates by January 1962, the women were subjected to an intensive battery of medical testing, including runs on centrifuges, pressure chambers, and vibration stands. A special Mandate Commission, which included Gagarin himself, narrowed the list down to three women at a meeting on March 3; the formal orders inducting them into the cosmonaut team were signed nine days later. Orders for an additional two women were signed on April 3. The five were:

- Tatyana D. Kuznetsova (twenty years old)
- Valentina L. Ponomareva (twenty-eight)
- Irina B. Solovyeva (twenty-four)
- Valentina V. Tereshkova (twenty-four)
- Zhanna D. Yerkina (twenty-two)"

While they were not Air Force pilots, each had well-suited assets for competing to be the first Soviet woman in space. Solovyeva, an alumni of Ural University, had 900 parachute jumps to her credit, followed by Tereshkova with seventy-eight and Ponomareva with ten. Ponomareva was clearly the most accomplished pilot, with 320 hours to her credit accrued on PO-2 and Yak-18 aircraft at her local sports club. She also had the distinction of having graduated from the prestigious Moscow Aviation Institute and having served as a scientist at the Department of Applied Mathematics of the USSR Academy of Sciences. Unwittingly, however, Ponomareva became the center of a controversy when Gagarin opposed her inclusion into the team because she was the only candidate who was a mother. Social stigma in the Soviet Union to mothers risking their lives in dangerous endeavors was significant enough for some vacillation on the issue. In the end, Academy of Sciences President Keldysh, who had encouraged her application in the first place, weighed in behind her, and her name was included in the final selection. One candidate, Tereshkova, did not have the academic honors to compete with the others, but had some other prized assets—for example, she had been an active member of the local Young Communist League near her home in the Yaroslavl Region on the upper Volga.⁷ As plans stood in early 1962, the women were to compete for a single seat on a Vostok mission during the latter part of the year.

The women cosmonauts arrived at the Cosmonaut Training Center at Zelenyy near Moscow at a time of great uncertainty about the next Vostok mission. Many of the systems and resources used for the Vostok program were common to the military Zenit-2 project, and having declared the latter an immediate priority, dates for the former were continuously delayed. The first Zenit-2 was launched on December 11, 1961, but it failed to reach orbit because of a failure in the third stage of 8K72K booster, the same launch vehicle used for the Vostok missions.⁸ The second launch attempt in January 1962 had to be aborted at the last moment. Forced to conduct an examination of the booster problems, Korolev postponed the dual-Vostok launch again. There were also problems with both the parachutes and life support systems on the Vostok spacecraft, which had emerged during ground testing in early 1962, instilling doubt in the ability of the spacecraft to carry out missions safely. The somewhat lackadaisical attitude

6 V. Semenov I. Marinin and S. Shamsutdinov *Iz istorii kosmonavtiki: uypusk I: nabory v otryady kosmonavtov i astronautov* (Moscow: AO Videokosmos, 1995) pp. 8–12; S. Yegupov and I. Karpenko "At the Request of Readers: Detachment of Air Forces Cosmonauts" (English title) *Aviatsiya i kosmonavtika* no. 5 (May 1990): 46–47.

7 Golovanov *Korolev*, p. 691; Facktor and Ponomareva "Women in the Early Soviet Spaceflight Program."

8 V. Agapov "Pages From History: Launches of the Zenit-2 Space Apparatus" (English title) *Novosti kosmonavtiki* 10 (May 6–19, 1996): 65–77.

from the government on piloted space exploration was given a sudden jolt by news from the United States. Since January 23, NASA had been attempting to launch Major John H. Glenn, Jr., on the first U.S. piloted orbital spaceflight. Although the launch was delayed several times over the following weeks, all the preparations were carried out amid a torrent of media attention, contrasting sharply with the extreme secrecy of the Soviet program.

The publicity surrounding Glenn's Mercury launch had a dramatic effect. With curious abruptness, Military-Industrial Commission Chairman Ustinov called Korolev on February 17, just three days before the NASA launch, and ordered the Vostok launch in mid-March, no doubt to take some of the steam out of the Mercury flight. Glenn's spectacular mission on February 20 began the ball rolling in the Soviet Union. The day after, Lt. General Kamanin short-listed a group of seven cosmonauts to begin intensive training for the dual-Vostok flight, with two flying and two serving as backups. Kamanin himself captured the haphazardness of the decision-making in his diary:

I was unofficially notified (by Ustinov) that the next flight should take place around March 10-12. Apparently, after Glenn's flight, Khrushchev demanded that our next piloted flight be brought forward. In order to fly around the 10-12th, we'll have to fly to the launch site on March 2-3. This is the style of our leadership. They've been doing nothing for almost half-a-year and now they ask us to prepare an extremely complex mission in just ten days time, the program of which has not even been agreed upon.⁹

The seven cosmonauts—Bykovskiy, Komarov, Nelyubov, Nikolayev, Popovich, Shonin, and Volynov—began mission-specific training at the time, but the resources were simply unavailable to mount a mission within thirty days. Month by month, the launch was again delayed as resources were tied up in the Zenit-2 program. At least two launches of the reconnaissance satellite were planned before Korolev could focus on the Vostok mission. The first of these finally occurred on April 26 with the successful orbital insertion of the first Soviet reconnaissance satellite. The second, using a slightly different model of the launch vehicle, was delayed several weeks and did not take place until June 1, 1962, from the launch pad at site 1, the same pad planned for use on the Vostok flights. In this case, the rocket landed 300 meters from the launch site, while one of the strap-ons remained at the pad, seriously damaging the structure as a result of a fire.¹⁰ The response to Glenn's flight was hopelessly delayed as engineers estimated a month of repair work to bring the pad back to operational status.

As with Titov's flight, the issue of the length of the two ensuing Vostok missions was the source of arguments that lasted months. Korolev was absolutely insistent that the first mission last three days and the second two days. This was in the face of the opinions from all the Air Force physicians, the cosmonauts, Kamanin, Academy President Keldysh, Chairman of the State Committee for Defense Technology Smirnov, and top Air Force leaders, all of whom favored a more conservative one-day mission for each, prolonged to two days if everything went well. Korolev, in typical fashion, bulldozed his opinions over a period of weeks and, by the end of June, had persuaded almost all of the key leaders directing the Vostok program, including the leading biomedicine specialist Vladimir I. Yazdovskiy. The latter capitulated despite a formal document signed by the leading physicians on September 23, 1961, stating: "At the present time there is no basis to plan the next space flight for more than one day. If during a day long flight the cosmonaut is in good physical health, then the flight can be prolonged, but not to

9 Kamanin *Skrytiy kosmos* 1960-1963 p 94 Hendrickx "The Kamanin Diaries 1960-1963 "

10 Agapov "Pages From History" Kamanin *Skrytiy kosmos* 1960-1963 pp 118-19

more than two days." Kamanin refused to give in, but as the weeks wore on, he found himself in a minority.

At the first meeting of the ad hoc State Commission for Vostok on 16 July, the members set the dual Vostok launches for August 5-10, 1962. The second spacecraft would be launched into orbit the day after the first. One of the primary goals of the mission was to launch the spacecraft in such a way that the two vehicles would pass by each other in close proximity. Although a rendezvous was beyond the means of the modest Vostok spacecraft, such a mission profile had an important application to long-range plans at OKB-1. One of the key elements of the 7K-9K-11K Soyuz circumlunar project was rendezvous in Earth orbit. The first part of the rendezvous, an approach to within twenty kilometers, would be achieved simply by the trajectory imparted to the spacecraft by the launch booster. This meant that the second spacecraft would have to be launched at a specific time, to a specific inclination, and the cutoff velocity had to be perfectly timed to enter the designated orbit and orbital plane. The whole procedure was complicated by Earth's rotation; the "rendezvous" had to be based on computations of the velocity at which Earth rotated the launch pad underneath the first overflying Vostok spaceship. According to the plan, the two spacecraft would pass by each other at a relatively far distance, continue their own missions, and then land simultaneously, the first Vostok after three days and the second after two days. On July 26, in a meeting at OKB-1, leading participants, including OKB-1 Deputy Chief Designer Bushuyev, Department Chief Raushenbakh, Gagarin, and Cosmonaut Training Center Director Karpov, discussed the possibility of having the cosmonauts observe each other's spacecraft in orbit. Because of propellant limitations in the attitude control systems, they limited observations to two options for the first cosmonaut: viewing the upper stage of the 8K72K launcher after orbital insertion and detecting the launch of the second Vostok while flying over Tyura-Tam." Observations of each other's spacecraft were not ruled out, but this was not a primary mission goal.

One safety concern that officials addressed in the weeks leading up to the launch of the Vostoks was nuclear radiation. On July 9, 1962, the United States detonated a nuclear warhead in space with the aid of a Thor missile over the Johnston Atoll in the Pacific Ocean. This generated high amounts of radiation that scientists believed was trapped in Earth's magnetic fields. Alarmed by the possibility that such radiation might harm the cosmonauts, the State Commission depended on the investigations of two small automated satellites, Kosmos-3 and Kosmos-5, which had been launched earlier in the year. The latter, in particular, was used to assess the degree of potential danger to humans flying over the Pacific. Noted nuclear physicist Sergey N. Vernov reported at a commission meeting on July 16 that as long as the launch was three to five days after a U.S. explosion, there would be no real danger to the cosmonauts."

After a final meeting of the State Commission presided over by Chairman Smirnov on July 30, the first participants, including the five cosmonauts training for the joint mission—

11 Kamanin *Skryty kosmos 1960-1963* pp 125-26 A description of a meeting on the issue of mission length in March 1962 attended by S P Korolev K D Bushuyev M K Tikhonravov O G Cazenko N P Kamanin and Ye A Karpov is described in Aleksandr Romanov Korolev (Moscow Molodaya gvardiya 1996) pp 445-49

12 Kamanin *Skryty kosmos 1960-1963* pp 128-29 William Shelton *Soviet Space Exploration The First Decade* (New York Washington Square Press 1968) p 139

13 V Pappo Korystin V Platonov and V Pashchenko *Dneprovskiy raketno kosmicheskiy tsentr* (Dnepropetrovsk FO YuMZ/KBYu 1994) p 69 Kamanin *Skryty kosmos 1960-1963* p 125 The summary report on the effects of Project Starfish has been published as M V Keldysh "On Radiation as a Result of High Altitude Nuclear Explosions" (English title) in V S Avduyevskiy and T M Eneyev eds *M V Keldysh izbrannyye trudy raketnaya tekhnika i kosmonautika* (Moscow Nauka 1988) pp 459-60 Another source suggests that Kosmos 7 was also used for the same task See V P Clushko ed *Kosmonautika entsiklopediya* (Moscow Sovetskaya entsiklopediya 1985) p 201 Kosmos 3 and Kosmos 5 were '2MS' class satellites launched on April 24 and May 28 1962 respectively (nos 1 and 2) Kosmos 7 was a Zenit 2 reconnaissance satellite (no 4) launched on July 28 1962

Bykovskiy, Komarov, Nikolayev, Popovich, and Volynov—began flying into Tyura-Tam on August 2. By the time Korolev and the other major chief designers arrived the following day, cosmonaut overseer Lt. General Kamanin was leaning toward Nikolayev and Popovich as the likely candidates for the two missions. One of the few bachelors in the cosmonaut team, the thirty-two-year-old Nikolayev began his career as a lumberjack before later joining the Soviet Air Force and receiving his pilot's wings in 1954. Possessed of a remarkably calm disposition, his completely unflappable manner in potentially life-threatening situations as both a pilot and a cosmonaut-trainee had guaranteed a place for him on such an early Vostok mission. The ebullient Popovich, also thirty-two, was Nikolayev's polar opposite in temperament. He had had a distinguished career in the Soviet Air Force before receiving the Order of the Red Star for an assignment in the Arctic. His wife Marina was one of the most accomplished women test pilots in the USSR."

Training for Nikolayev, Popovich, and their three backup cosmonauts continued almost to the day of their scheduled launch, which was set for August 10–11. On August 4, the cosmonauts received instructions on how to orient their spacecraft for observations as well as for maintaining a smooth roll motion throughout the mission for equitable heating from the Sun's rays across the entire spacecraft. Veteran cosmonauts Gagarin and Titov were intensively involved in all premission operations, having jumped from being mere cosmonauts to being important members of the State Commission participating in all the key decisions regarding the flights. Gagarin arrived at Tyura-Tam on August 6, along with State Commission Chairman Smirnov, who presided over a prelaunch technical review meeting the same night. The formal "go-ahead" session of the commission was held on the night of August 7. It was at that point that Kamanin formally nominated Nikolayev and Popovich to fly the missions. Cosmonauts Bykovskiy and Komarov were named their backups, while Volynov was named "reserve." Among the speakers at the meeting was First Deputy Commander-in-Chief of the Soviet Air Force Marshal Sergey I. Rudenko, who in his two-minute speech twice referred to cosmonaut Popovich as "Popov." The faux pas, recorded on film at the time, was later excised no doubt to save both Popovich and Rudenko from embarrassment. Remarkably, Rudenko repeated his error at a subsequent commission meeting the following day.

There were no major anomalies during the remaining days leading up to the first launch. On the morning of the liftoff, August 11, all the leading chief designers—Korolev, Alekseyev (ejection seat), Barmin (launch complex), Bogomolov (telemetry systems), Gusev (radio communications), Isayev (Vostok engine), Kosberg (upper stage engine), Kuznetsov (gyroscopes), Pilyugin (guidance systems for the booster), Tkachev (parachutes), and Voronin (life support systems)—met and declared their respective systems ready for flight.¹⁶

At 1130 hours Moscow Time, exactly as scheduled, the 8K72K booster lifted off with Captain Andrian G. Nikolayev aboard: his first words were "Full speed ahead!"¹⁷ Perhaps aware of the recent booster failures, Korolev was unusually nervous throughout the ascent phase of the flight as he held on tight to the red telephone with which he would give the vocal order to abort the mission in case of a booster failure. At T+687 seconds, ground controllers breathed a sigh of relief as the spacecraft, renamed Vostok 3, was successfully inserted into orbit. Initial orbital parameters were nominal: 180.7 by 234.6 kilometers at 64.98 degrees inclination to the equator. Approximately two hours into the mission, at the end of Nikolayev's first orbit, news

14 Shelton. *Soviet Space Exploration*, pp. 134–35, 142

15 Kamanin. *Skrytiy kosmos*. 1960–1963, pp. 133, 136–37.

16. The chief designers were heads of the following organizations: S. M. Alekseyev (Plant No 918), V. P. Barmin (CSKB SpetsMash), A. F. Bogomolov (OKB MEI), L. I. Gusev (NII-695), A. M. Isayev (OKB-2), S. A. Kosberg (OKB-154), V. I. Kuznetsov (NII-944), N. A. Pilyugin (NII-885), F. D. Tkachev (NIEI PDS), and C. I. Voronin (OKB-124)

17. Evgeny Riabchikov. *Russians in Space* (Moscow: Novosti Press Publishing House, 1971), p. 186

of the launch was reported to Khrushchev, Kozlov, and Ustinov back at the Kremlin. Kozlov called into launch control at Tyura-Tam, mistakenly promoting Nikolayev to lieutenant colonel instead of major before correcting himself. Throughout the mission, physicians on the ground kept a close watch on the cosmonaut's health to detect signs of the malaise that had afflicted Titov. A battery of sensors and instruments were attached to the cosmonaut's body, bringing in continuous telemetry; these included measurements for electrocardiograms, pneumograms, electroencephalograms, skin-galvanic reactions, and electro-oculograms. To measure movements of the eyes, doctors had attached tiny silver electrodes at the outer corners of Nikolayev's eyes to record the biocurrents of the muscles of the eyeballs. Electrodes placed on the front and lower third of the cosmonaut's right shin detected skin-galvanic responses. As was standard, the spacecraft also carried samples of *drosophila*, dry seeds, lysogenic bacteria, and microspores.¹⁸ The telemetric information was augmented by a continuous stream of oral reports on appetite, adaptability to noise, vibration, overstrain, and the ability to work and sleep.

Nikolayev reported none of the problems that Titov had experienced. For the first time on a Vostok mission, a cosmonaut was allowed to unstrap himself from his seat to float freely in the zero gravity inside the cabin. Air Force physician Yazdovskiy had warned Nikolayev that he may experience nausea and drowsiness on his sixth and seventh orbits.¹⁹ Nikolayev felt none and completed the "floating" experiment without any problems, bolstering Korolev's idea to have the mission last three days. During the mission, Nikolayev also had specially prepared meals, which, for the first time, were not packed in tubes.

Soviet leader Khrushchev spoke to Nikolayev from the ground control station of Simferepol about four hours into the mission, visibly excited as Nikolayev smiled on TV from outer space. In a surprise move, on the spacecraft's seventh orbit, a little more than six hours after liftoff. Soviet TV broadcast the first live pictures of Nikolayev. Viewers were able to see the cosmonaut move his arms and head via the two cameras mounted in the cabin. In a politically motivated move, the U.S. embassy was handed a document during the early part of the mission stating: "The United States must refrain from carrying out any measures which could in any degree hinder the exploration of outer space for peaceful purposes or endanger the cosmonaut's life."²⁰ It was an implicit reference to Project Starfish a month earlier, which had raised the possibility of delaying the Vostok 3 mission. U.S. officials assured the Soviet government that there were no plans for such upper atmospheric explosions in the near future, wishing Nikolayev "a safe flight and a happy landing."

Except for minor communications problems with the ground, Nikolayev's first day in space ended without incident: he went to sleep at 2200 hours. After a seven-hour nap, he awoke refreshed, awaiting the dramatic events of the new day. Activity at Tyura-Tam had continued at a feverish pitch following Nikolayev's launch. The pad at site I was cleaned out, and a new 8K72K booster with a Vostok spacecraft was wheeled in for launch. Major Pavel R. Popovich was launched successfully at 1102 hours, 33 seconds Moscow Time on August 12 into a 179.8- by 236.7-kilometer orbit inclined at 64.95 degrees to the equator. His spacecraft was named Vostok 4 upon orbital insertion. It was the first time in the history of spaceflight that more than one piloted spacecraft, or indeed more than one human, had been in orbit. Vostok 3's ground track had passed directly over Tyura-Tam at the time, and ten minutes prior to Vostok 4's launch. Nikolayev had manually oriented his ship so as to observe the launch plumes on the ground. He

18. George Wukelic, ed., *Handbook of Soviet Space-Science Research* (New York: Gordon and Breach Science Publishers, 1968), pp. 54-55; Kenneth Gatland, *Manned Spacecraft* (New York: Macmillan, 1976), pp. 118-19; Kamanin, *Skrytiy kosmos: 1960-1963*, p. 147.

19. Riabchikov, *Russians in Space*, p. 187.

20. Shelton, *Soviet Space Exploration*, p. 138.

was, however, unable to see anything. The surprise of the second launch was without precedent. The press in the West was literally agog with the possibility that the two craft might link up in space. Western "experts" on the Soviet space program, such as the British astronomer Sir Bernard Lovell, helped dramatize the situation by pronouncements claiming that the flights of Vostok 3 and Vostok 4 were "the most remarkable development man has ever seen."²¹

The two spacecraft were in very similar orbits and reportedly passed each other as close as five kilometers on Vostok 4's first orbit. During a postflight conference, Popovich claimed that he actually managed to see the other ship in orbit as "something like a very small moon."²² It seems, however, that neither cosmonaut ever spotted the other's spacecraft in orbit. Gradually, the distance between the two ships increased over the day to approximately 850 kilometers. The experiment was clearly a boon to Korolev's plans to use the 7K-9K-11K Soyuz complex for a circumlunar flight to the Moon because the latter mission required a precision of about twenty kilometers upon orbital insertion. Popovich and Nikolayev followed precisely synchronized schedules, dining and sleeping at the same time. In contrast to the reticent Nikolayev, Popovich was far more animated and jocular during his TV transmissions, showing viewers floating pencils and logbooks inside his cabin.

During the remainder of the missions, both cosmonauts performed modest physical exercises as well as sessions manually changing the attitude of their respective ships. The men also regularly communicated with each other, although there was some amount of static and noise that hindered fruitful exchanges during the early part of the missions. The cosmonauts ate four meals a day consisting of meat cutlets, roast veal, fillet of chicken, pastries, special sweets, miniature loaves, sausages, dragees, and chocolate. They also conducted extensive visual and photographic observations. Based on Titov's early experiments with movie-camera photography, both Nikolayev and Popovich used similar instruments. Nikolayev focused on imaging Earth's surface, while Popovich photographed Earth's horizon and terminator during several runs.²³

Originally, the State Commission had approved Korolev's proposal that the Vostok 3 mission last three days while the Vostok 4 flight last two days. By the late hours of August 13, the night before their scheduled landing, most State Commission members were of the opinion that Nikolayev's flight could be prolonged to four days. Kamanin was once again the only major participant who resisted the proposal, raising some fairly serious issues. The temperature aboard the Vostok 3 ship had abruptly dropped from 27 to 13 degrees Centigrade on Nikolayev's twenty-ninth orbit. Although the temperature had remained static since then, Kamanin believed that the mission should be kept to its original three-day length to preclude negative effects on the cosmonaut's health. Because 13 degrees was still above the limit considered for aborting a mission, and given that all other systems aboard the ship were performing nominally, all the chief



Cosmonaut Pavel Popovich is shown in a still picture during his Vostok 4 mission in August 1962 (files of Asif Siddiqi)

Originally, the State Commission had approved Korolev's proposal that the Vostok 3 mission last three days while the Vostok 4 flight last two days. By the late hours of August 13, the night before their scheduled landing, most State Commission members were of the opinion that Nikolayev's flight could be prolonged to four days. Kamanin was once again the only major participant who resisted the proposal, raising some fairly serious issues. The temperature aboard the Vostok 3 ship had abruptly dropped from 27 to 13 degrees Centigrade on Nikolayev's twenty-ninth orbit. Although the temperature had remained static since then, Kamanin believed that the mission should be kept to its original three-day length to preclude negative effects on the cosmonaut's health. Because 13 degrees was still above the limit considered for aborting a mission, and given that all other systems aboard the ship were performing nominally, all the chief

21 *Ibid* p 140 Kamanin *Skrytry kosmos 1960-1963* p 149

22 *Soviet Space Programs 1962-65 Goals and Purposes Achievements Plans and International Implications* prepared for the Committee on Aeronautical and Space Sciences U.S. Senate 89th Cong 2d sess (Washington DC U.S. Government Printing Office December 1966) pp 536-39 Reports differ as to the closest approach varying from five to six and a half kilometers

23 Yu. P. Semenov ed. *Raketno Kosmicheskaya Korporatsiya "Energiya" imeni S. P. Koroleva* (Korolev RKK Energiya named after S. P. Korolev 1996) p 116 *Gateway Manned Spacecraft* p 120

designers, including Korolev, Bogomolov, Kuznetsov, Alekseyev, and Pilyugin, voted to prolong the mission. In the end, Commission Chairman Smirnov had Cagarin personally ask Nikolayev's opinion on prolonging the mission. Although the brief communications session did not permit an informed decision on Nikolayev's part, he gladly agreed to the extension, saying that he felt "excellent."²⁴

The State Commission finally decided to prolong the Vostok 3 mission to four days and the Vostok 4 flight to three days on the early morning of August 14, just hours prior to the originally scheduled return of both cosmonauts. Thus, if all went well, both men would land in the late morning of the following day within minutes of each other. During their last scheduled day in orbit, Nikolayev and Popovich conducted some more Earth observation sessions. Popovich carried out an experiment with a pressurized flask two-thirds full with water. If the flask was left undisturbed, he reported that all the air coalesced in the middle of the flask. Upon shaking the container, Popovich discovered that the air would scatter in hundreds of small bubbles, which eventually came together into a single large air bubble in the middle." In an experiment to reproduce Titov's strange sensations, Nikolayev, on his fourth day in space, sharply turned his head from side to side repeatedly but felt no apparent discomfort. Popovich, on the other hand, experienced "some abnormalities," although it was nothing on the level of Titov's sickness.

On the night of August 14, Khrushchev and Kozlov telephoned Commission Chairman Smirnov and unexpectedly raised the issue of prolonging Popovich's flight another day to four days in the interest of not "offending" the cosmonaut. An unplanned meeting of the inner members of the State Commission—Smirnov, Korolev, Keldysh, Rudenko, Pilyugin, and Kamanin—was convened immediately to discuss the issue. Most of the members were in favor of extending Popovich's mission. Korolev himself was diplomatic:

The goals *having* been completely fulfilled, we have already extended Nikolayev's flight to four days, raising some risk. There's no reason to end *Popovich's* mission due to technical or medical reasons, but I do not see any great gains in prolonging his flight, although I will not vote against such a decision."

This time, not only Kamanin but also Cagarin, Bushuyev, Feoktistov and others opposed the proposal based on concerns about shifting landing zones as well as, incredibly, dropping temperatures in Vostok 4, which were down to eleven to twelve degrees Centigrade. This was just above the limit for safe conditions in the vehicle. Clearly under pressure to carry out the directives of Khrushchev and Kozlov, Smirnov did not want to give in and asked Korolev to put the question to Popovich. As one would expect, Popovich replied that he was ready to fly for four days. Smirnov, perhaps relieved, telephoned Khrushchev on the State Commission's decision to prolong the flight, adding that Kamanin, Cagarin, and others had opposed the recommendation.

All these plans fell to the wayside the following morning, August 15. During a regular meeting of the State Commission, controllers reported that the temperature on Vostok 4 was down to 10 degrees Centigrade, below safe levels, and the humidity had decreased to 35 percent. Popovich reported that he was *feeling* well when he woke up, but he added, "The temperature and humidity are continuing to drop, and I've tried all necessary measures but the decline is continuing." It was clear to most ground controllers that by Vostok 4's forty-eighth orbit, the safety of life support was threatened. At that point, Kamanin, Keldysh, and Rudenko demanded

24 Kamanin, *Skrytiy kosmos. 1960-1963*, pp. 144-45

25 Gatland, *Manned Spacecraft*, p. 120.

26. Kamanin, *Skrytiy kosmos: 1960-1963*, p. 152

27 *Ibid.*, p. 153.

that Popovich be brought back on the next pass over Soviet territory, which as it turned out was the very next orbit, the originally planned time for landing. Smirnov continued to insist that the flight be continued. These arguments became somewhat academic when Popovich reported that he was "observing a thunderstorm." Before the flight, Popovich had agreed to use a series of coded phrases to communicate any abnormalities during the flight. "Observing a thunderstorm" meant that he was suffering severe motion sickness. Not surprisingly, Popovich's report caused great alarm on the ground, and controllers tried to confirm the report by asking how he was feeling. Popovich, realizing his error in terminology, replied, "I'm feeling excellent. I observed a *meteorological* thunderstorm and lightning."²⁸ Both Kamanin and Gagarin were skeptical of Popovich's second report, believing that the cosmonaut had overcompensated for his first call of distress, perhaps because of embarrassment. Controllers later discovered that Popovich had in fact been observing a real thunderstorm over the Gulf of Mexico and that he was feeling perfectly fine.

The "thunderstorm" issue sealed the matter of Popovich's landing on the forty-eighth orbit. Thus, both Vostok 3 and Vostok 4 fired their retrorockets within six minutes of each other in the late morning of August 15. Nikolayev landed by parachute after a three-day, twenty-two-hour, twenty-two-minute flight, during which he had circled Earth sixty-four times. Popovich landed 200 kilometers away from his comrade after a two-day, twenty-two-hour, fifty-seven-minute flight and forty-eight orbits." It was a triumphant end to two missions that were, by all standards, spectacular achievements for the Soviet space program. Not only had ground services displayed the capability to rapidly launch piloted spacecraft in succession from the very same launch pad, but the entire ground tracking network had given an exemplary performance of its capabilities. Nikolayev, with his four-day mission, had also broken the previous world endurance record set by Titov a year before. By comparison, the longest U.S. piloted space mission at the time was a modest five hours. The cosmonauts themselves were recovered in good health, although cardiovascular responses did not return to normal until seven to ten days after landing. Both men's good physical state was a significant reassuring factor after Titov's performance had thrown doubt into the possibility of long-duration missions.

Nikolayev and Popovich, after their formal report to the State Commission on the evening of August 16, flew into Moscow two days later for a tumultuous reception at the Red Square hosted by Khrushchev, Kozlov, and others. In typical fashion, Soviet officials maximized the stunning effect of the dual-Vostok mission. At a press conference for the Moscow press on August 21 attended by both Nikolayev and Popovich, Academy of Sciences President Keldysh announced quite melodramatically:

The flights of Andrian Nikolayev and Pavel Popovich in the Vostoks 3 and 4 mark a new, notable stage on this road which brings us closer to the realization of interplanetary flights. The group flight of the spaceships is of great significance for the development of interplanetary stations, for the creation of spaceships and for the conquest of interplanetary routes."

28 Ibid. Golovanov. *Korolev*, p. 686.

29 These times are for the landing of the cosmonaut. In the case of the descent apparatus of the two Vostok spacecraft, the times were three days, twenty-two hours, nine minutes, fifty-nine seconds for Vostok 3 and two days, twenty-two hours, forty-four minutes for Vostok 4. See Glushko, ed., *Kosmonautika entsiklopediya*, p. 66.

30 *Soviet Space Programs, 1962-65*, p. 537. During the press conference, Popovich inadvertently stated in answer to a question that "Like Titov and Gagarin, I landed beside the ship," implying that Gagarin had parachuted out of the Vostok descent apparatus prior to landing. This was clearly contrary to the official position that Gagarin landed inside his ship. It is not clear whether Popovich was penalized for this "slip" from the official Party line.

Such statements, backed up by the lack of detailed information on the Vostok missions, helped foster a climate of awe about the Soviet space program; many Westerners believed that the Soviets could have docked the two spacecraft with each other. Korolev's First Deputy Chief Designer Mishin commented many years later on the building of myths:

The group flight . . . well, a day after launch, the first craft was over Baykonur. If the second craft were launched now with great precision, then they would turn out to be next to each other in space. And that's what was done. . . . The craft turned out to be 5 kilometers from each other! Well, since, with all the secrecy, we didn't tell the whole truth, the Western experts, who hadn't figured it out, thought that our Vostok was already equipped with orbital approach equipment. As they say, a sleight of hand isn't any kind of fraud. It was more like our competitors deceived themselves all by their lonesome. Of course, we didn't shatter their illusions."

Woman in Space

The program of flights in the Vostok program remained indistinct throughout the life of the project. Proposals would be floated—many of them rejected, some considered for months—and then they were eventually laid to the wayside. A major reason for such disarray was partly because of the military's cool attitude toward the missions, partly because of the fact that science played very little role in mission planning, but mostly because the Soviet leadership was not very interested in establishing a coordinated plan. One additional factor may have been Korolev's health. For years, he had been in poor shape, plagued by a variety of physical ailments exacerbated to a great degree by his overstretched schedule. Working eighteen hours a day straight for several weeks on end was not anathema to him: he was an incurable workaholic with the need to have his hand in the most trivial of matters in his giant organization. Soon after the Vostok 314 mission, he had been beset by intestinal bleeding, resulting in unbearable pain that had landed him in a hospital. After a long stay in the hospital, he was released on September 15 and was ordered to take a short vacation at the seaside resort of Sochi. True to his nature, he took his work there and spent hours on the phone or with visitors such as Kamanin and Yazdovskiy planning future Vostok missions."

After the Nikolayev and Popovich missions, it was clear that the next Vostok mission would include a woman, but the clutter of proposals from various factions made pursuing a particular course of action impossible. Days after the successful Vostok 3/4 mission. Chairman of the State Committee for Defense Technology Leonid V. Smirnov, the "ministerial" head of the space program, was foreseeing a lone flight of a woman as early as late October 1962. Kamanin, on the other hand, believed that it would be more prudent to carry out the flight in March–April 1963 as part of a joint flight with men on one or two other spacecraft. The men would perform seven- to eight-day missions, while the woman would be in space for two to three days." Given the delays associated with previous missions, the March–April 1963 date proved to be much more realistic, although, by November, it was still not clear whether the female mission would be a solo or a group flight.

The women themselves engaged in intensive training throughout 1962. The program included time in centrifuges being subjected to loads as high as ten g's, weightlessness training in Tu-104 aircraft, regular physical exercises, flight training in MiG-15UTI trainers, water

31. G. Salakhutdinov, "Once More About Space" (English title). *Ogonek* 34 (August 18–25, 1990), 4–5
32. Riabchikov, *Russians in Space*, pp. 198–99; Golovanov, *Korolev*, p. 772.
33. Kamanin, *Skrytyy kosmos 1960–1963*, p. 158

survival techniques, and theoretical studies on astronomy, astronautics, and the Vostok spacecraft itself. They also performed between seventy to eighty parachute jumps from Il-14 aircraft to master the landing phase of a Vostok mission. To a great extent, the women's training was marked by different motivations than the earlier training of the men. While the men could count on later missions if passed over at first, no such luxury was afforded the women. Only one woman out of the five would make it into space, the rest most likely being consigned to a footnote in history. This singular fact was not lost upon the women themselves, and it characterized their interpersonal relationships with an unusual sense of competitiveness rather than any sense of unity."

At the end of the training program, the youngest of the lot, twenty-one-year-old Kuznetsova, dropped out of the running, having performed poorly in the pressure chamber and the centrifuge. Ponomareva, the only scientist in the group, was a clear favorite based on her excellent health and theoretical performance. However, given the peculiar combination of sexism and political standards that was propagated by Kamanin, she was deemed to have "unsteady" morals. She was very Independent, self-assured, and probably much more accomplished than some of the men—that is, completely unacceptable in Kamanin's mind. The other contender for first place, Tereshkova, on the other hand, was reticent, modest, and "a model of good breeding."³⁵

In late November 1962, four of the five women took their final exams; Kuznetsova was absent at the time because of poor health. The remaining four all received excellent grades and were awarded the military rank of junior lieutenant and were formally inducted as Air Force cosmonauts. Kamanin summarized their strengths and weaknesses in his journal on November 29:

Ponomareva has the most thorough theoretical preparation and is more talented than the others — she exceeds all the rest in flight—but she needs a lot of reform. She is arrogant, self-centered, exaggerates her abilities and does not stay away from drinking, smoking and taking walks (although she has a husband and four-year old son). Solovyeva is the most objective of all, more physically and morally sturdy, but she is a little closed off and is insufficiently active in social work. Tereshkova — she is active in society, is especially well in appearance. makes use of her great authority among everyone who she knows. Yerkina has prepared less than well in technical and physical qualities, but she is persistently improving and undoubtedly she will be a rather good cosmonaut. We must first send Tereshkova into space flight, and her double will be Solovyeva. . . Tereshkova, she is a Gagarin in a skirt.³⁶

Although the four women were ready for their flight, there was still much uncertainty about the mission. There was still no clear consensus on whether it would be a joint mission with a second Vostok, and if so, whether the second spacecraft would carry a man or a woman. There were also purely technical issues: Plant No. 918 had run into serious problems in designing a pressure suit specifically for women. As with many other flights, the Soviet Party and government proved unable or perhaps uninterested in setting a specific timetable by which all its subordinate organizations could work. The two spacecraft for the proposed women's missions had already been manufactured and almost ready for flight by mid-1962, but the lack of action from the Military-Industrial Commission and the Central Committee kept them on the ground for another year.

34 Colovanov. *Korolev*. p. 691; Facktor and Ponomareva. "Women in the Early Soviet Spaceflight Program"

35 Kamanin. *Skrytiy kosmos 1960-1963*. p. 182

36 *Ibid.*, pp. 187-88

The options available for the women's flights were discussed at a meeting at OKB-I in mid-January 1963. Three options were given serious consideration for the flight, then set for April–May:

- A single flight of a woman on a Vostok ship lasting one to three days
- A group flight of two ships with women, one launched a day after the other, and both landing on the same day
- A group flight with one ship carrying a man for five to seven days and one ship carrying a woman for three days

The Air Force seemed to be leaning toward a group flight of two women, but these plans were thrown into flux by opposing institutional viewpoints. For example, at one point in late January, State Committee for Defense Technology Chairman Smirnov had expressed the opinion that only one spacecraft (3KA no. 7) be used for the women's flight, while the second one (3KA no. 8) be consigned as a museum piece. The implication was clearly that the female flight would be limited to a single ship and not a joint mission."

Apart from OKB-I, the primary motivator in supporting the Vostok program was the Air Force. Having been completely kept out of the entire missile business by the armaments people in the Strategic Missile Forces, the Air Force, as the overseer of the cosmonauts, was taking steps to vigorously support piloted space activities. While it may have been purely an interservice rivalry issue, the lobbying did produce results. Top Air Force leaders, including Commander-in-Chief Vershinin, were able to convince Ustinov and Smirnov of not sending a perfectly good spacecraft sent to a museum. On March 18, several leading Air Force generals along with Korolev met with Secretary of the Central Committee for Defense and Space Frol R. Kozlov. On the question of the female mission, Kozlov asked many questions, some pointed (Why is this necessary?) and some simply ignorant (Who among you is deciding to prepare the women?). It seems that the combined effort did produce results. On March 21, the Central Committee formally decided to move ahead with a group flight with one woman and one man, thus quashing any plans for a double-woman mission. The flight was tentatively set for "no earlier than" August 1963. OKB-I also received formal approval to manufacture four additional Vostok spacecraft by the end of 1963.³⁷ Thus, a whole seven months following the Nikolayev-Popovich flight, the Soviet leadership finally committed itself to the next Soviet piloted space mission.

There was some adjustment to this plan when Korolev's engineers discovered that the design lifetime of both the slated spacecraft was to expire in May–June 1963, well before the August deadline. Korolev had asked his men to explore the possibility of extending "the shelf life" of the vehicles, but he was informed that this would not be possible. Thus, OKB-I was put in a bind: either launch the two spacecraft by June 15 or throw them out. The revised plan was passed up to the Military-Industrial Commission and the Central Committee. The latter, on April 29, formally approved carrying out the group flight earlier, in May–June of 1963. The first spaceship would carry a man into orbit for a full eight days, while the second would carry the first woman into space for two to three days.

Cosmonauts Bykovskiy, Khrunov, Leonov, and Volynov were the four candidates for the male seat. Of the four, Bykovskiy and Volynov had been sporadically training for the possibility of such a mission since September 1962, but dedicated preparation for the joint flight did not begin until mid-April 1963, just two months before the planned launch. Such an unusually short preparation period, impossible in the case of NASA astronauts, was possible in the

37 *Ibid* pp 208 216–17 223–24

38 *Ibid* pp 238–39 240

Soviet Union because cosmonauts in training groups were in a continuous state of preparation for months prior to being assigned a particular flight. Through the month of May, the four went through an accelerated and compressed training program involving more parachute jumps, three- to four-daylong ground simulations, and tests on the centrifuge. Air Force officials expected that Bykovskiy and Volynov, the best trained of the four, would be ready for launch by May 30, while Khrunov and Leonov would be ready by June 15, just in time to make the mission." In a very telling comment in his journal, Kamanin wrote:

Because of the squabbling between various departments, we make very poor use of our technical capabilities, hastily preparing flight programs, and doing a lot of other stupid things. A space mission, or to be more exact, its preparation should begin with giving the crew a flight program, but we are doing exactly the opposite: we first prepare the ships and their equipment and then tailor the crew's flight program to the ship's configuration and equipment."

The flight program of the ensuing two missions was very similar to the Vostok 3/4 flight a year before. The length of seven to eight days for the first mission necessitated some changes in timing: the only requirement was that the two spacecraft fly in space at the same time for at least one to two days. None of the earlier Vostok missions had included any serious scientific experiments, and it seems the scientific community had taken steps to include some observational research on the new mission. On May 17, 1963, Academy of Sciences President Keldysh submitted a formal document to the Council of Ministers suggesting experiments on the next Vostok missions. These dealt with the study of the brightness of Earth's atmosphere system, especially the horizon, the structure of the clouds, the light regime, and the transparency of the atmosphere by means of black-and-white and color photography with subsequent photometric observations. A program of research that included these experiments was apparently prepared for the next dual-Vostok flight, although it is not clear whether all the instrumentation was actually carried into orbit.⁴¹

The first meeting of the State Commission for Vostok took place on May 10. Presiding was a new commission chairman, forty-eight-year-old Artillery Lt. General Georgiy A. Tyulin, at the time the First Deputy Chairman of the State Committee for Defense Technology. His career with the missile had begun in 1944 when, as a young lieutenant colonel, he had been tasked to study captured portions of the German A-4 missile. A close friend of Korolev's, Tyulin had petitioned several times to be transferred to OKB-1 as an engineer, but these requests had been denied because his expertise was needed elsewhere. After the year in Germany in 1945-46, he had ended up at the military research and development NII-4 organization directing the development of ground tracking stations for the R-7 ICBM and later sea-based tracking for space satellites. In August 1959, Tyulin was tapped to become director of the famous NII-88, the former "overseer" institute of Korolev's OKB-1. Within two years, both Ustinov and Korolev strongly supported Tyulin's nomination to enter the State Committee for Defense Technology, the "ministry" responsible for the space program. Tyulin, more committed to scientific and engineering research, was reluctant to leave his job at NII-88, but he agreed in June 1961 to

39 Ibid p 258 Cosmonaut Komarov was also briefly considered for the mission from early February to May 9 when he was dropped because of health problems

40 Ibid p 261 Hendrickx "The Kamanin Diaries 1960-1963"

41 The Academy of Sciences document has been published as M V Keldysh "On A Program of Observation in the Launches of the Vostok Spaceship" (English title) in Avduyevskiy and Eneyev eds M V Keldysh *izbrannyye trudy* p 477 An Instrument for the study of luminescence in the upper atmosphere was also proposed for the mission although Keldysh states in his letter that there would be some difficulty in placing the instrument in the Vostok capsule

become the committee's First Deputy Chairman. Tyulin stayed with his new job, clearly gaining a foothold in the top levels of the space industry.⁴² One of the most overlooked characters in the tapestry of the Soviet space program, he was also one of the most ubiquitous.

Traditionally, the position of chairman of the *ad hoc* State Commission for Vostok was held by an individual with a "ministerial" rank; the appointment of Tyulin, who had a rank of first deputy "minister," was unexpected. Clearly, the Communist Party no longer viewed the project as sufficiently important as before. Under Tyulin's supervision, the State Commission met on May 10 to discuss preparations for the flight. In attendance were all the principal participants preparing the woman flight, including both Korolev and Glushko. This was at the zenith of their fight over the NI propellants, and it is surprising that the two of them actually managed to sit in the same room and discuss a neutral project. Also present were several Strategic Missile Forces and Air Force officers, chief designers, scientists from the Academy of Sciences, veteran cosmonauts, and Air Force physicians." The relevant chief designers reported that both spacecraft slated for the flight had been tested and all defective instruments replaced. Korolev in particular complained of the poor quality of the workmanship of a particular plant, which had produced twenty-eight defective parts.

After the formal meeting, a smaller group provisionally agreed to set the two launches for June 3–5. The preliminary choice for the first mission was Bykovskiy, more than likely because he was the lightest of the men competing for the position: the Vostok spacecraft was already pushing the limit of the launch vehicle's capabilities with a variety of modifications. The decision on the woman was a little more difficult. A year before, when the five women had come to Tyura-Tam to see the launches of Vostok 3 and Vostok 4, Korolev had clearly been pleased with Tereshkova and had even confided this to then-Director of the Cosmonaut Training Center Col. Yevgeniy A. Karpov. Before the weeks leading to launch, however, two clear factions had emerged in picking a single woman. On one side, Korolev, Karpov, Kamanin, and parachute training instructor Nikolay K. Nikitin strongly supported Tereshkova's candidacy. There were, however, powerful forces behind the clearly well-qualified Ponomareva: Institute of Aviation and Space Medicine Director Lt. General Yuvenaliy M. Volynkin; leading space medicine specialist Vladimir I. Yazdovskiy, of the same institute; Academician Aleksandr Yu. Ishlinskiy, one of the most influential scientists in the space program; and, most important of all, Academy of Sciences President Keldysh. Gagarin, a powerful member of the State Commission, at first did not have an opinion on the issue, but on being pressured insistently by Keldysh, he "rebelled" against Keldysh and sided against Ponomareva. At the meeting on May 10, the vote on Tereshkova versus Ponomareva was split again, but the tide began to turn against Ponomareva soon. During a visit to the Cosmonaut Training Center on May 21 by Keldysh, Korolev, Mrykin, Rudenko, and others, Bykovskiy and Tereshkova were named the primary crewmembers of the two missions. According to former Cosmonaut Training Center Director Karpov, if Keldysh and physician Yazdovskiy had not been lobbying so intensely for Ponomareva, she would have been the first woman in space. At one point during his visit to the center, Korolev asked Ponomareva why she looked so sad. She simply answered, "I am not sad, I'm simply serious, as always."⁴⁴

42. Col. M. Rebrov, "Where the Cranes Fly" (English title). *Krasnaya zvezda*, September 19, 1987, pp. 3–4; Yu. A. Mozzhorin, "The Central Scientific-Research Institute of Machine Building—The Main Center in the Soviet Rocket-Space Industry" (English title). *Iz istorii aviatsii i kosmonavtiki* 60 (1990): 20–40; Yu. A. Mozzhorin, et al., eds., *Dorogi v kosmos* I (Moscow: MAI, 1992), p. 168.

43. Among those present were G. A. Tyulin (GKOT), G. N. Pashkov (VPK), S. P. Korolev (OKB-1), V. P. Glushko (OKB-456), V. P. Barmin (GSKB SpetsMash), A. Yu. Ishlinskiy (NII-944), G. A. Skuridin (AN SSSR), A. G. Mrykin (GURVO), K. A. Kerimov (GURVO), S. M. Alekseyev (Plant No. 918), G. I. Voronin (OKB-124), N. P. Kamanin (VVS), A. I. Kutasin (VVS), Yu. M. Volynkin (IAKM), L. I. Goreglyad (WS), M. I. Odintsov (TsPK), V. I. Yazdovskiy (IAKM), Ye. A. Karpov (TsPK), Yu. A. Gagarin (TsPK), and V. A. Smirnov (WS).

44. Kamanin, *Skrytiy kosmos: 1960–1963*, pp. 261, 266; Golovanov, Korolev, p. 691; Facktor and Ponomareva, "Women in the Early Soviet Spaceflight Program."

On May 27, the members of the State Commission flew into Tyura-Tam to oversee the launch preparations for the two 8K72K boosters and their respective payloads. Various chief designers identified a number of significant failures during a meeting on May 31, including problems with communications and TV systems, which prompted some heated exchanges. Tyulin delayed the launches to June 7-10 to eliminate all the anomalies. The cosmonauts, primary members Bykovskiy and Tereshkova, as well as backups Volynov, Solovyeva, and Ponomareva, arrived from Moscow the following day with about thirty other prominent space program leaders. The complete State Commission for Vostok assembled on the morning of June 4 to discuss and finalize preparations for the historic missions. All systems were declared ready for launch, although the possibility of launching on June 7 was put in doubt by the chance of high winds at the launch site. A "ceremonial" version of the State Commission meeting was later held for the benefit of a small group of Soviet journalists who were flown into Tyura-Tam. Kamanin officially nominated Bykovskiy for the eight-day flight of the first spacecraft, Vostok 5. His backup would be Volynov. Cosmonaut Tereshkova was nominated for the second mission, which would last between one and three days, based on the state of the cosmonaut and her spacecraft, Vostok 6. Solovyeva and Ponomareva would serve as backups for Tereshkova."

Once again, so as to fool the Western tracking stations that would monitor voice communications, the State Commission drew up a short list of coded messages the cosmonauts could send to the ground. "Feeling excellent, the ship's equipment is working excellently" would imply that there were no problems and that flight should continue. In place of "Feeling excellent," "Feeling well" would indicate that the cosmonaut had doubts about being able to fulfill the flight: "Feeling satisfactory" would mean that the flight had to be terminated immediately. The launch, set for June 8, had to be delayed by three to four days when a major problem with the remote radio command system arose. This and other malfunctions in the guidance and communications systems were the subject of a long State Commission meeting on June 7, during which the institute chief responsible for the offending radio system, Chief Designer Armen S. Mnatsakanyan of NII-648, explained that the failure in the system had occurred because of a single failed triode, a product of poor workmanship at the production plant.⁴⁵ The first launch with Bykovskiy was rescheduled for June 11. Tereshkova would follow into orbit two days later. An alternate variant was for Tereshkova to launch into space five days after Bykovskiy. Thus, the two could return to Earth together after Bykovskiy's eight days in space.

The delay proved to be only the first of many. On the night of June 10, Academy of Sciences President Keldysh, back in Moscow, sent a message to the State Commission in Tyura-Tam that solar activity had sharply increased, significantly raising radiation levels in the upper atmosphere. The commission decided to postpone the launch again. On the night of June 11, the solar activity issue was discussed in depth: a solar storm had evidently broken out on June 8 and was expected to last between five and perhaps up to eight days. Astronomers predicted a possible peak the very next day. The launch was postponed again to June 14-15 at the earliest.

Continually delaying the flight contributed to increased tensions at the launch site. Korolev had been seriously ill in recent weeks. He had a fever for several days and was diagnosed with inflamed lungs. He looked "pale and wane" to everyone, his voice hoarse from talking.⁴⁶ The stress on not only Korolev but also the other chief designers reached a breaking point on June 14, the day of the launch. At a last-minute, early-morning meeting of the State Commission, the members recommended a launch at 0900 hours Moscow Time, based on reduced solar activity. Trouble began soon after Bykovskiy arrived at the pad and was helped

45 Kamanin, *Skrytiy kosmos* 1960-1963 pp 268 274 276-78

46 *Ibid* p 282

47 Pavel Popovich and Alexander Nemov 'Galactic Secrets' in V Mitroshenkov ed *Pioneers of Space* (Moscow Progress Publishers 1989) p 206

into the ship. Controllers reported that both of the ultrashortwave transmitters on the Vostok ship were not functional. After a brief meeting, they decided to continue with the countdown and rely only on the short-wave transmitters for the mission. A little later, a pin stuck in the ejection hatch forced a thirty-minute delay. Finally, at T-5 minutes, the indicator light on the control panel for the Blok ʸ third stage of the booster refused to light up. The problem was traced to a failure in the gyroscope-instrumentation unit on the stage. Korolev's first response was to yell, "Where the hell's Kuznetsov?!"⁴⁸

Chief Designer Viktor I. Kuznetsov of NII-944, one of the original members of the Council of Chief Designers, was ultimately responsible for all gyroscopes on Soviet space launch vehicles. Perhaps the least well-known member of the council, he was originally a naval engineer. In the late 1930s, he had designed fire control stabilizers for the famous Kirov and Maksim Gorky cruisers in the late 1930s. In October 1940, Kuznetsov had been assigned to Germany during the brief period of the Stalin-Hitler pact. Once the Nazis attacked the Soviet Union, Kuznetsov suffered through a dramatic trip out of Germany into Turkey and finally back to the Soviet Union. After the war, he reluctantly joined the inspection teams into Germany, where he met Korolev, Glushko, and other soon-to-be chief designers. Kuznetsov told his associates, "Somewhere, they are producing new ships, while I must mess around with the fascist [V-2]."⁴⁹ In 1946, Special Committee No. 2 appointed him chief designer of NII-10, with the responsibility to create all gyroscope systems for Soviet long-range ballistic missiles. The tall, lanky chief designer was one of several men who had been spared a gory death during the R-16 disaster in October 1960 because of their need to smoke last-minute cigarettes. After the accident, he had headed the technical commission investigating the disaster when he came into conflict with the "total incompetence" of Soviet leaders. Kuznetsov remembers:

Brezhnev did not delve *into* the situation. He sat in his hotel room in his pajamas and constantly reminded [Kuznetsov]: "Moscow is waiting for the report. Don't dawdle over the details, just a few general conclusions—that is all . . ." ⁵⁰

Unlike the other members of the council, Kuznetsov was unusually reticent and quiet. Dressed perpetually in his leather jacket, he would always sit to one side of the room, rarely ever taking part in discussions during meetings of the State Commission." At the time of the Vostok 5 launch, Kuznetsov was fifty years old.

With tempers flaring, Korolev and Kuznetsov began heatedly arguing in front of their colleagues about the failure, which had potentially devastating consequences. If Kuznetsov's



Chief Designer Viktor Kuznetsov was responsible for the design of the gyroscope instrumentation for Soviet missiles, launch vehicles, and space-

craft. He was one of the six original members of the Council of Chief Designers. By the 1960s, his organization, NII-944, had become the Scientific-Research Institute of Applied Mechanics (files of Peter Gorin)

48 Colovanov. *Korolev*, p. 694. Yu. A. Skopinskiy, "State Acceptance of the Space Program Thirty Years of Work From the History of Science" (English title) *Zemlya i uselennaya* no 5 (September-October 1988): 73-79. Kamanin. *Skrytiy kosmos* 1960-1963, pp. 286, 288-289.

49 Col. M. Rebrov, "The Seven Faces of Fate. Pages From the Life of the Chief Designer of Rocket-Space Command Instruments" (English title), *Krasnaya zvezda*, January 7, 1989, p. 4.

50 *Ibid*

51. Colovanov. *Korolev*, pp 698-99.

engineers did not fix the failure within six hours, then the launch would have to be postponed for another day because of poor weather conditions during the landing opportunities for later launch windows. And if the launch was postponed, the 8K72K booster would have to be unfueled, taken back to the Assembly-Testing Building, and disassembled. In that case, the launch would have to be delayed to August. By August, the lifetime of the two Vostok spacecraft would have expired. Korolev and Kuznetsov thus had hours to make a decision that could potentially derail the piloted space program for another year. One of Kuznetsov's deputies finally reported that his engineers could replace the offending unit with a new one within two to three hours. Kuznetsov, in consultation with Pilyugin and Ryazanskiy, decided to go with the plan. State Commission Chairman Tyulin opted to keep Bykovskiy in his capsule through this period as the repairs dragged on to a full six hours."

As the final minutes clocked down to liftoff, the hopes for a successful launch seemed to be abruptly thwarted by indications in the ground bunker that the booster had not disengaged the cable connecting itself to the external power sources that fed the rocket during the entire countdown. With the seconds ticking away to launch, Korolev, Voskresenskiy, and Strategic Missile Forces launch operations chief Kirillov looked at each other in a moment of panic. In the handful of seconds remaining, they unanimously decided to launch. Although the launcher was still plugged into the ground supply, power had evidently switched to on-board systems. At ignition, the cable simply tore off its sockets and fell to the wayside."

Unaware of the drama, twenty-eight-year-old Major Valeriy F. Bykovskiy lifted off in his Vostok 5 spacecraft at 1458 hours, 58 seconds Moscow Time. His initial orbital parameters were 174.7 by 222.1 kilometers at 64.96 degrees inclination to the equator. The orbit achieved was slightly lower than anticipated, evidently because of the less-than-nominal performance by the third stage of the launch vehicle. Instead of the standard ten-day lifetime predicted for the other Vostok missions, Bykovskiy was given about eight days in space prior to natural decay. To maintain adequate safety margins, it was clear that Bykovskiy would not be able to stay in orbit for the seven to eight days originally planned. To the joy of ground controllers, the ultra-short-wave transmitters came back on line soon after orbital insertion. Bykovskiy was also able to observe the upper stage of the 8K72K booster moving away from him after orbital insertion. Soviet leader Khrushchev spoke to Bykovskiy, on a then-standard exchange of messages, on the fourth orbit. During his first two days, Bykovskiy carried out the usual flight program perfected over the previous Vostok missions, including checking and reporting on spacecraft parameters and his own health and conducting Earth observations. During one orbit, he tested the manual orientation system, finding that the pressure in the nitrogen bottles had reduced to ten atmospheres pressure. Because at least five atmospheres was required in case of manual orienting for reentry, Bykovskiy put the spacecraft in a thermal roll mode at one revolution per eight minutes. Later on his eighteenth orbit, he removed himself from his restraining straps and floated about in the relatively spacious capsule. TV transmissions continued to send down an endless stream of video of Bykovskiy's antics."

Through the first two days he spent alone in orbit, as part of his Earth observations program, Bykovskiy used a special movie camera to take black-and-white pictures of the horizon, the Moon, and Earth. Unfortunately, one of the film cartridges remained stuck in his camera: he found another cassette to be empty of film! One of the few scientific experiments included noting the growth of peas and observing the behavior of liquids in microgravity. The rest of his

52 Skopinskiy 'State Acceptance of the Space Program' Kamanin *Skrytiy kosmos 1960-1963* p 289
Lt Gen Georgy Aleksandrovich Tyulin 'Task For the Future Notes of the State Commission Chairman' (English title) *Krasnoya zvezda* April 3 1988 p 4

53 Colovanov *Korolev* p 699

54 Riabchikov *Russians in Space* pp 200-01 Kamanin *Skrytiy kosmos 1960-1963* p 298

tion was limited between physiologic research or more Earth observation. The former program included modest calisthenics and noting the edge of his vision in orbit with special filters (which he found difficult to use). As part of the latter program Bykovskiy used special filters with special light filters to observe Earth and Sun's corona (which he was unable to see). As with the previous Vostok missions, a large complement of biological specimens accompanied Bykovskiy: these included cancer cells, amnion and fibroblast cells, frog ova and sperm, drosophila insects, plants, air dried seeds, chlorella algae, and bacteria⁵⁵

As Bykovskiy finished up his second day in space, back on the ground. Tereshkova was preparing for her moment of fame. Late on June 15, a final meeting of the technical group of the State Commission had taken place: Tereshkova's launch was set for 1230 hours Moscow Time the following day. Earlier, Commission Chairman Tyulin had received a message from Moscow announcing that in Tereshkova's launch communique, TASS would announce that she was a civilian and not a military officer. By this time, only Tereshkova and Solovyeva were involved in actually preparing for the mission; third trainee Ponomareva was consigned to ground support functions. On the day of the launch, Tereshkova arrived at the pad in the late morning and was greeted by Korolev, Tyulin, and other members of the State Commission. This time, the prelaunch preparations were far more uneventful. Jr. Lieutenant Valentina V. Tereshkova, twenty-six, lifted off at 1229 hours, 52 seconds Moscow Time on June 16 in her Vostok 6 spacecraft. Within minutes, she had successfully entered orbit, thus becoming the first woman in space. Her initial orbital parameters were 180.9 by 231.1 kilometers at a 64.95-degree inclination to the equator. The orbit of Vostok 6 was in an orbital plane about thirty degrees apart from that of Vostok 5, in contrast to the Vostok 3/4 combination when the second vehicle had been launched as the first was directly over Tyura-Tam. Because of the slightly different mission profile, the two new vehicles only approached each other twice for a few minutes every orbit."

Throughout the world, Soviet news services poured forth a plethora of rhetoric linking the flight to the inevitable progress of socialism. While there were some Westerners who correctly identified the flight as an exercise in pure propaganda, most were further cowed by the breadth and ambition of the Soviet space program. As Kamanin had predicted two years before, the flight was a brilliant political success all over the world.

Vostok 5 and Vostok 6 flew closest to each other immediately after launch, when they passed each other at a range of about five kilometers. Bykovskiy later reported that he had not



Here are three women cosmonauts at Tyura Tam prior to the launch of Vostok 6. Left to right are Valentina Ponomareva, backup Irina Solovyeva and prime crewmember Valentina Tereshkova. Behind the women are State Commission Chairman Georgiy Tyulin (left) and Strategic Missile Forces Commander-in-Chief Sergey Biryuzov. (files of Asif Siddiqi)

55. Wukelic, ed. *Handbook of Soviet Space-Science Research* pp. 346-48; Kamanin, *Skrytiy kosmos: 1960-1963*, pp. 298-99.

56. Phillip J. Klass, "Vostok 5 May Have Separated Too Early," *Aviation Week & Space Technology*, June 24, 1963, pp. 34-35.

spotted Vostok 6, while Tereshkova thought she might have glimpsed Vostok 5. Like Bykovskiy, she did, however, view the third stage of the booster rocket. The two cosmonauts established communications contact with each other by 1300 hours, and within three hours, Moscow TV was showing live shots of Tereshkova in her capsule. It seems that Tereshkova may have briefly suffered from the same affliction that marred Titov's flight two years before. The Soviets later reported that she:

was not feeling so well on the first few orbits. The commission was even discussing the possibility of ending the flight of Vostok-6 ahead of schedule. [Tyulin] talked it over with Tereshkova by radio. She asked that the flight not be interrupted, said that she already felt better (that was later verified with the telemetry data), and assured the State Commission that she would carry out "everything that the program called for" and would do "everything as we were taught."⁵⁷

On the morning of June 17, the technical group of the State Commission decided to curtail Bykovskiy's mission down to five to six days because of his lower-than-nominal orbit. Unless there was an emergency, Tereshkova's flight would last the complete three days. Both cosmonauts reported feeling excellent through the day; communications between the two vehicles were maintained only in the first part of the day, apparently the last communications the two had during the remainder of the mission. On the morning of June 18, the State Commission finally decided on landing times for both cosmonauts: Bykovskiy would return on his eighty-second orbit at the end of his fifth day, with Tereshkova coming back on her forty-ninth orbit at the end of her third day. The former would set an absolute world endurance record, far surpassing the longest U.S. piloted space mission of the time.⁵⁸ Tereshkova continued to report that she felt excellent, but TV transmissions on June 18 showed her tired and looking a little weak. Ground controllers were very disappointed when Tereshkova failed to perform one of the major goals of her mission: manual orientation of her spacecraft. For reasons that are unclear, it seems that she had attempted to use the attitude control system but was unable to do so. This caused much anxiety on the ground because if the automatic system failed during reentry, Tereshkova would have to orient the ship manually.

Kamanin ordered Gagarin, Titov, Nikolayev, and OKB-1 Department Chief Raushenbakh to send up instructions to Tereshkova on manual orientation. On the morning of June 19, on her forty-fifth orbit, Tereshkova successfully carried out a twenty-minute experiment in manual orientation, keeping her vehicle in the correct attitude for reentry for a full fifteen minutes. Korolev and the other members of the State Commission were somewhat reassured by her performance, mitigating concern that she might not be able to orient the craft manually if needed for reentry." Bykovskiy raised somewhat of a scare a day earlier when he transmitted a message to the Khabarovsk ground station on short wave that "At 9 hours 5 minutes there was the first space knock."⁵⁹ This report was immediately passed on to Korolev and Tyulin, and there was lively

57 Skopinskiy "State Acceptance of the Space Program" p. 76

58 This was L. Gordon Cooper's Mercury Atlas 9 mission in May 1963 which had lasted one day, ten hours, and twenty minutes.

59 There is still some confusion about Tereshkova's manual orientation exercises in orbit. Some otherwise reliable sources suggest that she never completed any of these tests. See Golovanov *Korolev* pp. 700-01. B. Ye. Chertok *Rakety i lyudr goryachye dni kholodnoy voyny* (Moscow: Mashinostroyeniye, 1997) pp. 235-38. On the other hand, N. P. Kamanin in his personal diaries from the time of the mission suggests otherwise. See Kamanin *Skrytiy kosmos 1960-1963* p. 295.

60 Chertok *Rakety i lyudr* p. 236. Kamanin *Skrytiy kosmos 1960-1963* p. 295. Gatland *Manned Spacecraft* pp. 122-23.

speculation on everything from meteor strikes to extraterrestrials. Soon, when ground control directly asked Bykovskiy about the incident, he replied that what he had said was that "there had been the first space stool," the Russian word for "stool" (*stul*) being mistaken for the word for "knock" (*stuk*). Either way, it was a historic moment because it was the first time a human had had a bowel movement in space, another dubious first for the Soviet space program.

The postflight reports by both cosmonauts were illuminating. Bykovskiy commented that he excitedly looked forward to the scheduled periods when he would float unstrapped inside his ship (which he did on the eighteenth, thirty-fourth, fiftieth, and sixty-sixth orbits). On one occasion, he floated for an entire orbit, although he found it difficult to orient himself when his eyes were closed. He also had some comments about instrument placement inside the Vostok cabin, suggesting that although the switches were accessible, the indicators were hard to read. In addition, the food rations were placed in a difficult position to access, and the medicine cabinet was simply too far to reach without unfastening himself. His helmet also apparently weighed him down. Problems with the waste management system also cropped up during the last portion of his time in space. Despite these minor inconveniences, he claimed that he felt excellent throughout the mission.

Tereshkova was more candid in *her* postflight report:

I took movie films of cities, clouds, and the Moon . . . removing the film [from the camera] was very difficult. I didn't conduct any biological experiments—I was not able to reach the objects. The dosimeter remained at zero. The sanitary napkins moistened very poorly and were too small. It's necessary to have something to clean teeth. I carried out observations with light-filters. The horizon was luminous over the poles. Over South America I observed a storm. At night the cities were defined very sharply. The Moon illuminated the Earth and the clouds very beautifully. It was difficult to determine the constellations. I didn't observe the solar corona."

She was very forthright about the conditions in the vehicle and the difficulties she had faced:

On the first day I didn't feel the spacesuit. On the second day there was a nagging pain on my right knee and by the third day it had begun to worry me. The helmet bothered me pressing against my shoulder. . . [it also] pressed against my left ear. The sensor belt [around my head] did not disturb me. [However] the sensors themselves gave me itches and headaches.⁶²

These experiences were more than likely a comment about the poor level of comfort afforded by the Vostok spacesuit than any bad experiences on Tereshkova's part. Throughout her reports from orbit and in her postflight report, she emphasized that she had felt well during her mission:

Weightlessness did not arouse any unpleasant sensations. . . . The bread was dry and so I didn't eat it. The juice and the cutlet were pleasing. I threw up once but this was due to the food, and not to any vestibular disorder.⁶³

61 Kamanin *Skrytiy kosmos 1960–1963* p 300

62 *lbt* pp 300–01

63 *lbt* p 301

The order for firing the reentry engine on Vostok 6 was sent at 0939 hours, 40 seconds Moscow Time on June 19. Tension was high at the control center at NII-4 near Moscow because Tereshkova had not reported on the proper work of the solar orientation system. In fact, for some inexplicable reason, she remained silent throughout the reentry, not reporting on the retrofiring or the separation of her spacecraft modules. She safely ejected from her capsule at six and a half kilometers altitude, but while she was parachuting down, in violation of the training procedures, she had looked up to the side of the parachute canopy at the upper line of the pressure suit's helmet, when a piece of metal hit her straight on the nose." She touched down without further incident after a two-day, twenty-two-hour, fifty-minute mission about 620 kilometers northeast of the town of Karaganda in Kazakhstan. Bykovskiy's reentry was more eventful. As with Gagarin and Titov, his instrument compartment failed to separate on time from the spherical descent apparatus prior to reentry into the atmosphere. He recalled later that the separation was "disorderly." but the problem seems not have perturbed him too much. He landed after a record-breaking four-day, twenty-three-hour, six-minute mission about three hours after Tereshkova and 800 kilometers away."

Tereshkova's health during her mission has been the subject of much speculation for many years. with the more sensationalist stories suggesting she was completely sick when she landed." There were clearly two factors that played against her: she was unable to test the attitude control system when required and did not conduct any medical experiments. After touchdown, she had also apparently given all the remaining food in her capsule to the villagers who greeted her, completely contrary to mission rules. This made it difficult for doctors to verify her assertion that she had eaten 60 percent of the food aboard the Vostok 6 spaceship during her three days in space. As physicians led by Yazdovskiy jumped to attribute a pitiful performance on her part. Tereshkova became defensive, claiming that she had felt well during the flight, although she had suffered from fatigue and lack of sleep. Yazdovskiy eventually wrote up a hypercritical report on Tereshkova's mental and physical state during the mission, stating that she had felt poorly on the thirty-second and forty-second orbits, had vomited, had a poor appetite, and had "weak cardiac activity." All of this eventually reached Korolev's ears, and he invited the young cosmonaut on July 11 to speak one-on-one about her flight. What they spoke about is not known, but Korolev was clearly displeased with her performance. Kamanin wrote later: "I remember well all our troubles during the Tereshkova flight. There were many disruptions, and when Tereshkova finally landed. Korolev said: 'If I ever get involved with broads again...'" Korolev's First Deputy Mishin was even more extreme: "Tereshkova turned out to be at the edge of psychological stability. It would seem that her flight . . . should have discredited Khrushchev."⁶⁸

Part of this hostility toward Tereshkova was clearly because she was a woman. The standards by which all the engineers, physicians, and military officers judged her performance were completely different than for the men. Titov, who had suffered severe motion sickness and was unable to do many of the tasks assigned to him during his mission, was never considered a pariah after his flight. Unlike Tereshkova, he was recycled into other space projects, and neither

64 Tyulin "Task For the Future" *Riabchikov Russians in Space* pp 204-05

65 The times given are for the landing of the cosmonaut in his or her parachute. The mission durations for the descent apparatus of the two vehicles were four days twenty two hours fifty six minutes and forty one seconds (for Vostok 5) and two days twenty two hours forty minutes and forty eight seconds (for Vostok 6) See Glushko *Kosmonautika entsiklopediya* p 66

66 See for example Leonid Vladimirov *The Russian Space Bluff* (New York: The Dial Press 1973) pp 114-15

67 L. N. Kamanin "In the Future His Name Will Probably Be . . ." (English title) *Ogonek* 7 (February 9-16 1991) 28-31 Kamanin *Skrytiy kosmos 1960-1963* pp 308-315

68 Salakhutdinov "Once More About Space" p 5

Kamanin nor Korolev believed that he had failed their trust in him. Thus, while Tereshkova's flight was not an outright success, it was also by no means the complete failure as that seen by Kamanin and Korolev. At the time, of course, all this was talked about behind the curtain of the Soviet space propaganda machine. One of the most publicized aspects of Tereshkova's mission was that she had flown in space longer than all the six Mercury flights combined, certainly a fantastic achievement considering the political dimension of the "space race." Bykovskiy, for his part, had also claimed a new victory for the Soviet space program. Traveling a total distance of 3,325,957 kilometers during his flight, he had set an absolute world duration record. For a single-crew spaceship, it is a record that still stands today, thirty-five years after his mission.

At the time that Bykovskiy and Tereshkova completed their flights, there were no approved plans for subsequent missions in the Vostok series. Korolev was probably keen to discontinue the program and instead concentrate resources on flying the more advanced 7K-9K-11K Soyuz complex and the N1 booster projects. The flights in June 1963 were thus effectively the last in perhaps the most historically important Soviet piloted space project. Between 1961 and 1963, despite growing political bickering, the Soviets had managed to launch the first human into space, conduct the first daylong flight, carry out the first "group flight," conduct the longest space mission to date, and launch the world's first woman into orbit. It was a stunning show of form for a nation whose technological capacity had been dismissed by many.

Cosmonauts Under the Public Eye

The publicity afforded to Tereshkova's historic mission was capped off by an even more sensational public relations extravaganza: Tereshkova's wedding to the "most eligible Russian bachelor," Vostok 3 pilot Nikolayev. A few Russian historians have cynically suggested that their union was a public relations exercise, perhaps engineered by Cosmonaut Training Center Director Karpov or his boss Kamanin. This may have indeed been true. Although Nikolayev and Tereshkova were good friends, most accounts from the time suggest that the two were hardly close enough to be husband and wife." Regardless of their own feelings on the matter, the plans for marriage began to take a life of their own. In the first state-hosted wedding in Soviet history, Nikolayev and Tereshkova were married to each other on November 3, 1963, just four months following the latter's spaceflight. Attendees included all the top leaders of the space program: Khrushchev, Malinovskiy, Biryuzov, Smirnov, Keldysh, Rudenko, Serbin, and others. In what must be considered the rarest of opportunities, both Korolev and Glushko were allowed to attend this most public of ceremonies at the Government Reception House. The names of neither were, of course, announced, nor were they allowed to sit close to Khrushchev or Tereshkova. Western correspondents who were also invited evidently discovered through informal conversation that the "chief designers" of the Soviet space program were in attendance. Within a week, a New York Times correspondent was able to file the following report:

Reports circulating in Moscow's Western community last week have mentioned two rocket pioneers as likely key figures in the Soviet space program. Although the identities of the top scientists in these jobs remain an official secret, a number of unofficial reports have been pointing to two academicians. *Valentin P. Glushko*, a combustion engineer, and *Sergei P. Korolyov*, a mechanical engineer. These reports cannot be confirmed from official sources. The leading figures in the Soviet space effort have been cloaked behind

such designations as Chief Designer and Chief Theoretician, which always appear in the Soviet press with capitalized initials.⁷⁰

With the identification of Korolev and Clushko, one might have believed that the machinations of the enigmatic Soviet space program would become clearer to Western observers. But even U.S. intelligence services seemed to be having a difficult time in determining exactly who ran the Soviet space program—a question that no doubt often boggled those within the program itself. As late as April 1961, the Central Intelligence Agency was claiming that the Soviet space effort was directed by the "Interagency Commission for Interplanetary Communications under the Astronomy Council of the Academy of Sciences," a body that had been publicized by the Soviet media in the mid-1950s ostensibly to serve as a public forum for their participation in the International Geophysical Year."

In the early 1960s, the six cosmonauts who had flown in space were the most visible ambassadors of the Soviet space effort, and they were packed off to scores of countries. They were portrayed as flawless representatives of the socialist system at levels often approaching hero worship. Behind the veils of secrecy, they were, of course, as fallible as any other men and women. Trainee Major Rafikov was dismissed from the cosmonaut team on March 24, 1962, because of a variety of offenses, including womanizing and "gallivanting" in Moscow restaurants, and so forth." Although Rafikov had requested that he be reinstated into the team after a few years, he never returned to cosmonaut training.

A much more serious loss to the team occurred a year later on March 27, 1963, when three unflown cosmonauts—Nelyubov, Anikeyev, and Filatev—were returning to the training center at Zelenyy after dinner in Moscow. They had apparently been drinking and became involved in an altercation with a military patrol on a railway platform. Nelyubov threatened to go over the head of the offended officers if they filed a formal report against the three of them. Top officials at the Cosmonaut Training Center requested that the duty officer not file a report against the three, and the latter reluctantly agreed, provided that Nelyubov apologize for his behavior. Although Anikeyev and Filatev agreed to make amends, Nelyubov categorically refused. The offended duty officer filed a report against the three of them, and within a week, the top Air Force leaders decided to dismiss all three from the cosmonaut team. Their official dismissal orders were signed on April 17. Losing Nelyubov, one of the most qualified and brightest cosmonauts, was particularly hard to accept for the other pilots. He had served as Gagarin's second backup during the first Vostok mission, and he certainly would have gone on to fly one of the early Vostok flights had it not been for Kamanin's disapproval of his "individualistic" ways. There was some discussion among Kamanin and the cosmonauts in later months on bringing Nelyubov back into cosmonaut training, based on Nelyubov's performance at his new assignment in an Air Force unit in the Soviet far east. This never happened. It seems that Nelyubov suffered from a psychological crisis through the following years, as cosmonaut members junior to him started flying their space missions. By 1966, he was despondent. The final Air Force report in his name merely stated: "On Feb. 18, 1966, while in a state of drunkenness, he was killed by a passing train on a railroad bridge at Ippolitovka station on the Far Eastern Railroad."⁷³

70 Theodore Shabad 'Soviet Space Planners Identity Believed Known' *New York Times* November 12 1963 p 2 Nicholas Daniloff *The Kremlin and the Cosmos* (New York Alfred A Knopf 1972) pp 67-70 A Soviet defector named C A Tokaty Tokayev had claimed that Korolev and Clushko were key figures in the Soviet space program in a lecture to the British Interplanetary Society as early as September 1961 See C A Tokaty 'Soviet Space Technology' *Spaceflight* 5 (March 1963) 58-64

71 U.S. Central Intelligence Agency 'National Intelligence Estimate 11-5-61 Soviet Technical Capabilities in Guided Missiles and Space Vehicles' Washington DC April 25 1961 p 50

72 Kamanin *Skrytiy kosmos 1960-1963* pp 99-100

73 Yaroslav Golovanov 'Cosmonaut No 1 Selection' (English title) *Izvestiya* April 5 1986 p 3

He was thirty-one years old at the time. The other two—Filatev and Anikeev—also did not resume cosmonaut training. Filatev returned to the Air Defense Forces before eventually becoming a teacher. He passed away on September 15, 1990, at the age of sixty. Anikeev died two years later on August 8, 1992, at the age of fifty-seven.

Of the cosmonauts who had flown, the most prominent was clearly Gagarin, but his time-consuming unofficial job as ambassador-at-large for the Soviet Union did not seem to be a role he particularly relished. In part because of his importance as a national monument, Air Force officials were incredibly reluctant to allow him to resume training for space missions. To keep him on the ground in a high-visibility position, in July 1963, Kamanin seriously considered offering Gagarin the job of director of the Cosmonaut Training Center. As one would suspect, Gagarin was not at all enthusiastic for a desk job and declined several times, despite pressure from the general. Later in the year, he finally buckled under continuing pressure that he become a deputy director at the center. Having been promoted from an Air Force major to a colonel in the space of two years, Gagarin was appointed Deputy Director for Flight and Space Preparations at the Cosmonaut Training Center on December 21, 1963.⁷⁴ For the moment, his chances of making it back into space were nil.

When Gagarin assumed his new job at the Cosmonaut Training Center, while he may not have been in flight training, there were plenty of others from which to choose. A brand new group of cosmonaut-trainees had in fact arrived at Zelenyy in 1963 to complete a yearlong training program before assignment to future Vostok and Soyuz missions. While the first batch of twenty cosmonauts were young Air Force pilots with little higher education, the new group of fifteen military officers all had higher degrees from a military academy or a civilian university. The selection was limited not only to pilots, but also to military engineers and navigators, adding significant expertise to the cosmonaut team from a wide variety of backgrounds. Of the group, eight were from the Air Force, four from the Strategic Missile Forces, two from the Air Defense Forces, and one from the Navy. The age limit on this second group, raised to forty, meant that the new trainees were almost all older than the Gagarin group. Air Force Commander-in-Chief Vershinin signed orders formally inducting the fifteen men into the cosmonaut corps on January 11, 1963.⁷⁵ The most qualified member of the group, thirty-five-year-old Air Force Major Vladimir A. Shatalov, was appointed the informal leader of the group, as they conducted their preliminary training programs through the next twelve months.

During the period 1960–63, the Cosmonaut Training Center itself grew at a rapid pace on the promise of a vast and expansive piloted space program of the future. While originally the cosmonauts conducted training sessions at simulators on the premises of the Air Force's Institute of Aviation and Space Medicine or at specific design bureaus, by the mid-1960s they no longer needed to leave the center. Buildings around the original complex were annexed as at least seven new devices were added: a Treadmill Facility and an Ontokinetic Drum in 1960, the Rotor three-stage rotating cab and a Rocking Platform in 1961, a Shielded Room and a Hot Room in 1962, and an Anechoic Chamber in 1963. A specially equipped Tu-104L flying laboratory was consigned to the center in 1961 for flying parabolic trajectories to simulate short periods of weightlessness. Although most of the original cosmonaut-trainees were Air Force pilots, they had refrained from dedicated air training until 1963, when a top Air Force test pilot.

74 Lardier *L'Astronautique Soviétique* pp. 137–38. Gagarin's immediate superior was Maj. General N. F. Kuznetsov, the new director of the Cosmonaut Training Center, who had been appointed to his post on November 20, 1963. He replaced Maj. General M. P. Odintsov, who had clashed repeatedly with the cosmonauts during his short eleven-month stint in the position.

75 Yegupov and Karpenko "At the Request of Readers" Semenov, Marinin, and Shamsutdinov *Iz istorii kosmonavtiki: vypusk I* p. 8. Rex Hall "Soviet Air Force Cosmonauts" in Michael Cassutt, ed., *Whos Who in Space: The International Space Year Edition* (New York: Macmillan, 1992) p. 211.

Vladimir S. Seregin, was tapped to head an air squadron specifically for the cosmonauts. Money was also apportioned for an athletic stadium, a large swimming pool, a huge housing complex, and even a restricted-access train station for employees and cosmonauts commuting from Moscow." The center employed 600 people by 1963.

Until 1963, the Institute of Aviation and Space Medicine provided all the ground and flight medical support to the piloted space program. Officially, the Cosmonaut Training Center was subordinate to this institute. By 1962, however, the center had clearly outgrown its original mandate as a temporary training ground for cosmonauts, evolving into the Soviet Air Force's primary means to maintain some control over the Soviet space program. On April 10, 1962, the center became a separate and official entity, no longer subordinate to the Institute of Aviation and Space Medicine." In addition, underlying the growing importance of space exploration to a newly interested Air Force, the service introduced the new post of First Deputy Chief for Space of the General Staff. As the first holder of this ranking, Lt. General Kamanin would continue to be the primary overseer of all activities related to cosmonaut training and the planning of piloted space activities on behalf of the Air Force.

These changes had the one negative effect of limiting the influence of the Institute of Aviation and Space Medicine. Its diminished authority was tempered by its critical say over every single aspect of space biomedicine in the Soviet space program, but even this function began to slip out of its hands by late 1963. The Ministry of Health, yet another party of the Soviet government eager to covet for itself a place in the Soviet space program, heavily lobbied through the year to bring all space biomedicine research under its wings, thereby leaving the Air Force institute without a mandate. The Air Force could only helplessly watch as the ministry's request was parlayed through the right political corridors during the summer of 1963. On October 26, 1963, a new entity, the Institute for Biomedical Problems (IMBP), was established in the Third Chief Directorate of the Ministry of Health.⁷⁶ The idea to establish a dedicated space biomedicine entity was not new; as early as May 1959, Korolev and Keldysh had written to the government on the need for such an institution. In many ways, the formation of the new institute was a delayed, but nonetheless concrete response to that important letter. The new Institute itself was established by joining together several subdivisions from the Air Force's old Institute of Aviation and Space Medicine, thus neutralizing much of the agenda of the latter. As many military physicians migrated to the new institute, the Air Force entity lost its all-important place in the pantheon of Soviet space exploration. Having been involved in space biomedical research since 1949, after 1963, it faded into the background.

The new IMBP became the first civilian institution in the Soviet Union dedicated to the study of the physiological effects of space exploration. It eventually became responsible for all Soviet medical and biological support for human spaceflight, including providing ground support to piloted missions, planning and carrying out space biology experiments in space, selecting and training cosmonauts, and developing various generations of life support systems. Andrey V. Lebedinskiy, sixty-two, a student of the famous Soviet scientist Pavlov, was appointed to head the new institution. Among its eventual employees were all the progenitors of the space biomedicine field in the Soviet Union—Oleg G. Gazenko, Abram M. Genin, Nikolay N. Gurovskiy, and Vasilii V. Parin—all of whom served as visible ambassadors to the Soviet space program at conferences throughout the world in the 1960s. It continued to play the same role for the *Mir* space station into the late 1990s

76 Col V Gorkov "History of the Soviet Space Program" (English title) *Aviatsiya i kosmonavtika* no. 2 (February 1990) 42-43

77 Kamanin *Skrytiy kosmos 1960-1963* p 102

78 Lardier *L'Astronautique Soviétique* p 147 The negotiations on the establishment of the new institute had begun as early as April 1963

Fighting in the Military

Supervision over biological research in the space program was only one facet of the control that the Air Force relinquished during this period. As the space program gained strength in the early 1960s, there was a vigorous battle within different armed services within the Ministry of Defense to gain operational control over the space program. The so-called "artillerymen" had inherited the role of primary clients of the ballistic missile program in 1946, consolidating their position through the 1950s with the strong arm of the late Marshal Nedelin. Their position was entrenched in 1959 with the formation of the Strategic Missile Forces, which through its Chief Directorate of Reactive Armaments served as the primary financiers of all missile weapons. With the emergence of the space program, the Strategic Missile Forces widened their agenda to the new area, forming new departments within the Chief Directorate dedicated to space. Key Strategic Missile Forces personnel were also sprinkled throughout the space industry at various levels, influencing every aspect of the space program, including such key programs as the NI and Soyuz.

The early 1960s proved a difficult time for the Soviet military as a whole. As the famous Soviet physicist Andrey D. Sakharov later wrote, "Khrushchev appeared anxious to limit the resources invested in military technology and [wanted to] concentrate on the most effective programs." These attempts to "curb military expenditures and to demilitarize the economy . . . provoked resistance in the armed forces." The one service that benefited from the restructuring was the Strategic Missile Forces, which threw all their resources into the development of new ICBMs. Space as a component of military policy was only barely emerging at the time, and the Strategic Missile Forces were remarkably uninterested in the piloted space program, seeing the Vostok, Soyuz, and NI projects as a colossal waste of money. These programs were funded and supported only grudgingly by the two Strategic Missile Forces Commanders-in-Chief during the 1960–63 period: Marshals Kirill S. Moskalenko and Sergey S. Biryuzov. Their opinions were bolstered significantly by USSR Minister of Defense Rodion Ya. Malinovskiy and his Deputy Andrey A. Grechko, both of whom on more than one occasion took the opportunity to rail at the "uselessness" of the piloted space program.

The Air Force stepped in and tried to take advantage of this vacuum. Through the early 1960s, it vigorously attempted to establish for itself what it saw as its rightful position as the leader of Soviet piloted cosmonautics. All its proposals were aimed at the use of cosmonauts for military purposes—ideas that were discussed at a number of conferences dedicated solely to the military applications of piloted spaceflight. Although Air Force leaders such as Commander-in-Chief Marshal Vershinin supported Chelomey's Kosmoplan-Raketoplan approach, they were also of the opinion that immediate goals could be achieved by modifying the Vostok spacecraft. Korolev was in a difficult position over this conflict. Until 1960, OKB-1 had almost no contact with the Air Force. Through the development of various ballistic missiles in the 1940s and 1950s, it had been the artillerymen who had worked closely with Korolev's engineers. They had developed close relationships, and among Korolev's engineers at least, there was a definite allegiance with the Strategic Missile Forces stemming from these long friendships. But it was the Air Force pushing piloted human spaceflight, while the Strategic Missile Forces were remarkably uninterested in spaceflight in general. Korolev clearly had to negotiate the matter delicately because he did not want to alienate either side. On several occasions in 1962–63, he promised the Air Force that he would convince Malinovskiy and even Khrushchev on the need to have the Air Force fully take over the Vostok program. At the same time, he continued to promise the Strategic Missile Forces that he could produce better ICBMs for them.⁸⁰

79. Andrey Sakharov, *Memoirs* (New York: Alfred A. Knopf, 1990), pp. 210–11.

80. Chertok, *Rakety i lyudi*, pp. 229–30; Kamanin, *Skrytyy kosmos: 1960–1963*, p. 166.

The core of Air Force proposals, beginning in late 1961, addressed the issue of ordering the construction of ten Vostok spacecraft specifically to fly military missions. In September 1962, cosmonauts Nikolayev and Popovich, fresh off their joint flight during the summer, were asked to report to the scientific-technical council of the Ministry of Defense's General Staff on the possible uses of the Vostok spacecraft for military purposes. Issues such as reconnaissance, interception, and attack—that is, those things analogous to maneuvers of a fighter aircraft—were on the agenda. The cosmonauts suggested that while the Vostok spacecraft could be used for piloted reconnaissance, newer vehicles would be needed for interception and attack. But Air Force leaders such as Vershinin had to ultimately clear their proposals with Malinovskiy, Grechko, and General Staff Chief Marshal Matvey V. Zakharov, and none seemed to have any inkling to pursue the idea. Lt. General Kamanin recalled:

*After an hour . . . I was once again convinced of the utter callousness of our military leadership. Grechko, and then Malinovskiy twice refused to order the "Vostoks." The General Staff's [Scientific-Technical Committee] and Zakharov, altered our document, asking the Minister to order 4 "Vostoks." Malinovskiy refused, declaring literally the following: "The Vostok' ship does not have any military importance, and we will not accept it into armaments or order it. . . ."*⁸¹

Somewhat dramatically, Kamanin added:

*History repeats itself: exactly 50 years ago, the Tsar generals evaluated the military applications of aircraft in the same exemplary fashion. Malinovskiy, Grechko, and Zakharov let pass the possibility for the creation of the first military space power. . . .*⁸²

As was customary in the Soviet space program, this was not the final word on the issue. It seems that Marshal Zakharov had a change of heart, and on November 9, 1962, the Air Force finally issued a proposal on new Vostok missions in support of the Air Force. These were to include:

- Ordering ten new Vostok spacecraft
- Equipping the Vostok for military applications, such as reconnaissance, interception, and attack
- Carrying out two military missions in 1963, one with a man in orbit for eleven to twelve days and another with a dog for thirty days
- Launching ships with dogs to extremely high orbits
- Carrying out special experiments, including landing by manual orientation, landing within the ship, depressurization of the ship in space, and so on⁸³

The persistent lobbying by highly placed Air Force representatives eventually produced a compromise result. On February 8, 1963, the Military-Industrial Commission issued a formal decree (no. 24), signed by its Chairman Ustinov, calling for future Vostok missions for biomedical research. As part of this plan, four Vostok spacecraft, down from the ten requested by the Air Force, would be constructed by OKB-1 within the first half of 1963. Ustinov also called for a formal report in two weeks' time on the possibility of augmenting the fairly rudimentary capabilities of the Vostok spacecraft. In a month's time, all the major players in the space pro-

81. Kamanin. *Skrytyi kosmos: 1960–1963*, p. 174.

82. *Ibid.*, pp. 174–75.

83. *Ibid.*, p. 178.

gram—the State Committee for Defense Technology, the Ministry of Defense, and the Academy of Sciences—were to submit to the Military-Industrial Commission a report on "a program of work on the mastery of cosmic space with the aid of piloted space objects in the next two years, which would ensure the absolute primacy of the USSR in this direction."⁸⁴ A Central Committee decree the following day, February 9, gave the decision a forceful measure." Fighting over limited resources, the Chelomey camp, in the person of State Committee for Aviation Technology Chairman Dementyev, immediately protested the decision, invoking "other important goals"—those presumably worked on by Chelomey—but it seems the Air Force had invested sufficient support into the decree to neutralize the opposition.

The approval of the plan to build four new Vostok spacecraft, supported by both OKB-1 and the Air Force, accelerated the planning for post-woman-flight missions during the 1963-64 period. As Air Force plans stood in February 1963, three of the new vehicles would be used for flights of single cosmonauts on flights lasting up to six to ten days. The fourth would carry a dog on a thirty-day mission. All four, Vostoks 7, 8, 9, and 10, would be equipped with experiments supplied by the Air Force. Korolev addressed the salient points of this plan in a report to the Central Committee on March 21 as part of a larger discussion on the future of the Soviet piloted space program. Knowing full well that he would find no allies within the Strategic Missile Forces, Korolev tried to rush headlong into an alliance with the Air Force by suggesting that all functions related to the preparation and accomplishment of Vostok flights be transferred to the Air Force.

The Air Force's insistence on assuming a lead role in the piloted space program came at a time when the Soviet space program finally began to assume an independent character. While the Strategic Missile Forces may not have been particularly interested in financing human space projects, they were not exactly amenable to giving up control over space program operations inherited by default in the late 1950s. The question of who controls space program operations—that is, launches, command, control, communications, military space forces, and most importantly finances—was an issue that pit the Air Force and the Strategic Missile Forces in a vicious interservice battle within the Ministry of Defense during 1963-64. At risk lay the future of Korolev's grand vision of Soviet human exploration: the Strategic Missile Forces would halfheartedly support it and in most cases oppose it, while the Air Force could be counted on to give its full support.

On March 28, 1963, Marshal Biryuzov, the new chief of the USSR Ministry of Defense General Staff, signed a decree (no. 216888) calling for the formation of a commission to discuss the military future of the 3KA variant of the Vostok spacecraft, implicitly addressing the issue of control between the Strategic Missile Forces and the Air Force. The odds were heavily stacked against the Air Force: of the eight members, only one person was from the Air Force (Marshal Vershinin), while the rest were from the Strategic Missile Forces. Vershinin immediately proposed Air Force control over "orders, adoption, launch, and control," and just as quickly, the Strategic Missile Forces rejected it. Through the following months, the two services continued to fight the matter out. Korolev visibly threw his full support behind the Air Force and may have tried to influence high military officers. At one point in late 1963, Biryuzov and new Strategic Missile Forces Commander-in-Chief Marshal Nikolay I. Krylov seemed to have considered handing control over to the Air Force. This brief interlude was temporary. In December 1963, the Ministry of Defense General Staff tabled a final proposal for the formation of a "directoriate" within the Ministry of Defense that would unite the various agencies in the military engaged in space activities, with the exception of cosmonaut training and the search

84 *Ibid.*, pp 222-23

85 A second decree from the Central Committee and the USSR Council of Ministry on the construction of the four Vostoks was issued on April 13 1963 See *ibid* p 253

and recovery services for space capsules, which would remain with the Air Force." It seems that the Air Force resisted the idea, but in vain. In October 1964, the Ministry of Defense established the Central Directorate of Space Assets (TsUKOS), whose agenda was "modernization of existing [space complexes] and the creation new space complexes, and the carrying out of the constantly expanding activities of multi-goal space systems."

TsUKOS was established on the basis of an existing department within the Strategic Missile Forces's Chief Directorate of Reactive Armaments (GURVO), which, since September 1960, had been overseeing space operations for the military. The effect of the 1964 reorganization was to separate TsUKOS from GURVO and subordinate it directly to the commander-in-chief of the Strategic Missile Forces. Henceforth, TsUKOS served as the primary "client" entity for almost all assets created for the Soviet space program—that is, specifications for all space projects had to be approved by TsUKOS. Subordinated to it were two control centers: one created in March 1963, called the Center for Leading the Development and Production of Space Armament Assets, and the other, the Center of the Command-Measurement Complex, which oversaw the nationwide tracking, communications, and flight control stations of the space program." The first commander of TsUKOS was Maj. General Kerim A. Kerimov, a forty-six-year-old artillery officer who was one of the many who had gone to Germany to capture A-4 remains after World War II.⁸⁹ Kerimov was a natural choice for the position, having served as the head of the smaller Strategic Missile Forces department on space issues. He was also a prominent member of the State Commission for Vostok, representing Strategic Missile Forces interests within the piloted space program. Although Kerimov was well liked and respected by Korolev, the formation of TsUKOS was a setback to the chief designer's long-range plan for human space exploration. With the Air Force effectively shut out of financing the space program, all the major leaders of the military—Malinovskiy, Grechko, Biryuzov, and Krylov—were decidedly "anti-space" in their actions, and reluctant to fund Korolev's "idle dreams." The artillerymen had won again. And Korolev would suffer the consequences.

The Genesis of Voskhod

The Soviet Air Force had lost much of its clout during the deliberations that led to the creation of TsUKOS in 1964. But the battles left behind one important legacy: the approved order from the Communist Party and the government in the spring of 1963 allocating funds to build four Vostok spacecraft in support of piloted missions during 1963–64. These four vehicles formed the basis for all immediate planning for piloted spaceflight in the near future. For the more distant future, OKB-1 envisioned the use of the 7K-9K-1 I K Soyuz complex, whose pri-

86 *Ibid* pp 245–46 398

87 Yu P Maksimov ed. *Raketnyye voyska strategicheskogo naznacheniya* (Moscow RVSN 1992) p 49
I D Sergeev ed. *Khronika osnovnykh sobyitij istorii raketnykh voysk strategicheskogo naznacheniya* (Moscow TsIPK 1994) p 17 N P Kamanin in his diaries suggests that Marshall S S Biryuzov and A A Crechko were strong supporters of putting TsUKOS under the control of the Air Force. Apparently, a commission created by Biryuzov in 1964 had come to this conclusion. Kamanin implies that after Biryuzov's death in October 1964 in an air crash pro-Strategic Missile Forces officers used the opportunity to put TsUKOS under the Strategic Missile Forces. See N P Kamanin *Skrytyi kosmos kniga vtoraya 1964–1966gg* (Moscow Infortekst IF 1997) pp 113 247

88 V V Favorskiy and I V Meshcheryakov eds. *Voyenno kosmicheskyye sily (voynno istoricheskiy trud) kniga I kosmonavtika i uoruzhennyye sily* (Moscow Sankt Peterburgskoy tipografii no 1 VO Nauka 1997) pp 101 112

89 *Ibid* p 112 Sernenov ed. *Raketno Kosmicheskaya Korporatsiya* p 603 Kerimov's first deputy was V I Shcheulov. His two other deputies were A A Maksimov (also chief of the Center for Leading the Development and Production of Space Armament Assets) and A G Karas (also chief of the Center of the Command Measurement Complex)

mary goals were rendezvous and docking in orbit, leading to circumlunar flight. Korolev's plans for the Soyuz complex were characteristically far too optimistic. In August 1962, he set the first automated Soyuz mission for May 1963. The work burden at OKB-1 was, however, far too heavy to maintain such an ambitious schedule. Apart from intensive work on Vostok, engineers at the design bureau were also engaged in the development of the Zenit-2 reconnaissance satellite; the Molniya-1 communications satellite; the Elektron scientific satellite; automated lunar, Venusian, and Martian probes; and new launch vehicles such as the NI. Work also included modifications to the Vostok booster. Certainly the most important work at OKB-1 in the early 1960s was not space but the development of long-range ballistic missiles for the Strategic Missile Forces. These included the R-9 ICBM and its modifications, the RT-1 and RT-2 solid-propellant ballistic missiles, and the GR-1 orbital bombardment system. While Korolev's heart may have been in space exploration, it is a gross miscalculation on the part of Western analysts to suggest that OKB-1 was overburdened with space-related projects. By far the largest portion of its resources continued to be siphoned off for missile-related programs.

The general direction of the Soviet space program was the subject at hand during a meeting of the Interdepartmental Scientific-Technical Council for Space Research on December 6, 1962. In attendance were all the major chief designers as well as representatives from the Academy of Sciences, the Strategic Missile Forces, and the Air Force. The council proposed a summary list of goals in the 1963-64 period for approval by the Military-Industrial Commission. Besides the numerous automated programs suggested, the council recommended the launch of ten to twelve Vostoks and four to six Soyuz spacecraft as part of the Soviet human space program.⁹⁰ These issues were discussed at the Central Committee level in March 1963, but as a result of the battle between the Air Force and the Missile Forces, the orders for the Vostok were curtailed; the Soyuz program was simply delayed by technical problems as well as poor resource management. After the historic Bykovskiy-Tereshkova mission in June 1963, Korolev was adamant about moving full-speed ahead with the Soyuz program, leaving Vostok to the Air Force. But delays in the former were significant enough to revise that approach. Instead, Korolev looked to the Air Force to use its four Vostok vehicles as a stopgap effort to continue piloted exploration in Earth orbit until the Soyuz came on line.

Taking a cue from original Air Force conceptions, Korolev produced a plan in early July 1963 for near-term Vostok missions. He proposed four missions. The first would be a ten- to eleven-day flight of a dog in Earth orbit at an altitude of 600 to 1,000 kilometers in February-March 1964. The goals of the mission would be twofold: to study the physiology of the dog in an extended period of weightlessness and to investigate the effects of radiation at high altitudes on a living organism. Based on the results of the dog flight, the remaining three Vostoks would carry single cosmonauts on flights in orbit up to ten days each. The spacecraft themselves would be modified from the original 3KA variant to accommodate a wide range of scientific and military experiments. The new missions were discussed at another huge gathering of space program leaders on July 26, 1963, dedicated to the future use of the Vostok spacecraft—a vehicle that was rapidly nearing obsolescence, almost five years after its original conception. OKB-1 Deputy Chief Designers Konstantin D. Bushuyev and Pavel V. Tsybin presented reports that there remained a wide variety of tasks that the Vostok could carry out, including flight to altitudes of 1,000 to 1,200 kilometers for up to ten days with a single cosmonaut. Most of the other speakers—from the military, the defense industry, and various design bureaus—supported this conclusion. It is not clear why all these individuals, clearly cognizant of the limited capabilities of the Vostok, continued to support the "old" Vostok. A rational course of action would have been to

90. Kamanin, *Skrytiy kosmos: 1960-1963*, pp. 191-92.

completely abandon the by-then primitive spacecraft and focus all resources on the Soyuz spacecraft—a vehicle that was a significant qualitative leap in space operations. One of the factors may have been the delays in the Soyuz project itself and the need to maintain a significant piloted presence in space during the interim. Korolev, in his report at the meeting, concluded that:

The "Soyuz" ship will fly no earlier than 1965, therefore in 1964 we should fly the "Vostok." We have already built four "Vostoks." and it's necessary to build 6-8 more. A program of flight to altitudes of 1,200 kilometers with extended flight to 10 days with significantly broadened scientific and military research is fully acceptable and can be carried out. It will be necessary to install a reserve breaking engine, work on the accomplishment of soft-landing, have improved long-range communications and television [systems], as well as to [increase] the volume and capacity of scientific research.⁹¹

The serious intent of OKB-1 in modifying the original 3KA Vostok variant was emphasized by a study completed at the design bureau at the time that resulted in the issuance of a document titled "On the Possibility of Using the 'Vostok' Ship for Experimental Research on the Prospective Problems of Cosmonautics."⁹² The eight primary objectives of the series of missions were:

- Extended piloted flights up to ten days
- Flights in orbits with apogees up to 1,000–1,200 kilometers
- The training of cosmonauts in realistic conditions of spaceflight
- Earth and astronomical observations as well as communications experiments
- Scientific studies of Earth's upper atmosphere
- Biomedical investigations
- Manual landing of the descent apparatus, with the goal of achieving a more comfortable return
- The "exit" of a test animal from the ship into open space

To achieve these goals, engineers would modify the original 3KA Vostok spacecraft in the following ways:

- Install a parachute-reactive system for landing on Earth
- Expand biomedical instrumentation
- Install equipment for the *Vykhod* ("Exit") experiment, which would include a depressurizable special container for an animal
- Add new scientific experiment instrumentation
- Add improved guidance and control systems, communications systems, and optical sensors"

The Air Force drew up a final manifest for Vostok missions in December 1963, which included four missions:

⁹¹ Ibid p 325

⁹² This document a scientific technical "certificate" has been reproduced in full in as S. P. Korolev "On the Possibility of Using the Vostok Ship for Experimental Research on the Prospective Problems of Cosmonautics" (English title) in M. V. Keldysh ed. *Tvorcheskoye naslediyе akademtkа Sergeya Pavlovicha Koroleva. Izbrannyye trudy i dokumenty* (Moscow: Nauka, 1980) pp. 457–60

⁹³ Ibid. Details of the goals and modifications can be found in Asif A. Siddiqi "Cancelled Missions in the Voskhod Program" *Journal of the British Interplanetary Society* 50 (January 1997) 25–32

- Vostok 7: a flight of an animal for thirty days into an orbit of 600 kilometers
- Vostok 8: a flight of a cosmonaut up to eight days
- Vostok 9/Vostok 10: a group flight of two cosmonauts up to ten days⁹⁴

To support these missions, the Cosmonaut Training Center formed a group of eight cosmonauts on September 17, 1963, consisting of all the remaining members of the original Gagarin group who had still not flown in space.⁹⁵

These piloted missions were timed to conclude the Vostok project at a time when the first Soyuz spacecraft would begin flying in early 1965. Progress on the 7K-9K-11K Soyuz projects had been remarkably slow since the Interdepartmental Scientific-Technical Council on Space Research had approved the basic goals and technical aspects of the program in May 1963. Originally, Korolev had planned the first automated 7K missions by mid-1964, but because of a combination of technical and financial difficulties, he continually revised this timetable through the months. Money was clearly a significant factor, exacerbated by the lack of a government decision in favor of the project. By early November 1963, Korolev was publicly complaining that he "had no money" to continue to work on Soyuz. By the end of 1963, OKB-1 had plans to build the first four Soyuz spacecraft in 1964, which would consume 80 million rubles; at the time, the Military-Industrial Commission had only committed to 30 million."

The Communist Party and the USSR Council of Ministers issued a joint decree on December 3, 1963, finally committing to the 7K-9K-11K Soyuz project with an ultimate goal of piloted circumlunar flight." The primary client of the new generation of Soviet space spacecraft would be the Strategic Missile Forces. The Air Force and the Air Defense Forces would only "take part" in the development of tactical-technical requirements for the Soyuz and its test flights. As specified in the decree, the first flight-ready model would be available by August 1964, with the second and third by September. This decision effectively put OKB-1 in the position of having to work simultaneously on the manufacture of two completely different piloted spacecraft, the Vostok and the Soyuz, for the following year. The situation raised management problems in assigning priority of one over the other. Korolev was insistent that the Soyuz fly by the end of 1964, a mantra he had repeated through the preceding year endlessly to all those who would hear. There was clearly a reason for the insistence, and it had less to do with maintaining previously set timetables than to respond to actions thousands of kilometers away.

NASA had carried out the last Mercury mission successfully in May 1963, thus verifying the technology necessary to maintain a human in Earth orbit for a short period of time. Well before that last flight, plans for a second-generation spacecraft were already on the drawing boards. As early as December 7, 1961, NASA Associate Administrator Robert C. Seamans formally approved a "Mercury Mark II" vehicle proposed by the former Space Task Group, which had been renamed the Manned Spacecraft Center.⁹⁶ This new spacecraft would be capable of conducting extensive rendezvous and docking operations in Earth orbit, allowing astronauts to acquire experience in advanced operations required in the Apollo lunar landing program. By January 1962, the project had been renamed Gemini, and in March 1963, NASA established guidelines for conducting extravehicular activity (EVA) operations in orbit by the pilots of successive crews. The Gemini project was clearly a qualitative leap in abilities over either the

94 Kamanin *Skrytiy kosmos 1960-1963* p 391 In an OKB 1 report prepared in December 1963 Korolev proposed four preliminary biological missions with dogs (instead of one) plus three human flights

95 The eight cosmonauts were P I Belyayev V V Corbatko Ye V Khrunov V M Kornarov A A Leonov G S Shonin B V Volynov and D A Zaykin See *ibid* p 382

96 *Ibid* p 388

97 Semenov ed *Raketno Kosmicheskaya Korporatsiya* p 163

98 Linda Neuman Ezell *NASA Historical Data Book Volume II Programs and Projects 1958-1968* (Washington DC NASA Special Publication (SP)-4012 1988) p 155

Mercury or Vostok; it would be capable of changing orbits, it would carry two astronauts, and it would allow flights lasting as long as two weeks. The only competitor it had was the Soyuz spacecraft. but by early 1964, it was clear to Korolev that Soyuz would not be ready by late 1964 or early 1965. By that time, Gemini would already be flying.

With Gemini looming over the horizon, Soviet space officials were in a difficult situation. Their options were slim: none of the four projected Vostok missions in 1964 would compare to a Gemini flight. The Soviet flights were all with a single cosmonaut, none of them included EVA, and none of them would have the capability to change orbits. In this climate, a most unlikely idea emerged—one whose origins remain obfuscated to this day amid clouded memories. Most accounts from this period suggest that Soviet leader Khrushchev contacted Korolev and ordered him to convert the Vostok spacecraft into a vehicle capable of carrying not two but *three* cosmonauts. Such a mission, if successfully accomplished, would be guaranteed to retain the Soviet lead in space, at least in the public eye. Korolev's First Deputy Mishin recalled in 1990 that "Khrushchev phoned Korolev and ordered the launch of three cosmonauts right away."⁹⁹ Air Force Lt. General Kamanin's personal diaries seem to confirm that the idea did not originate from Korolev, but he does not mention Khrushchev specifically. On February 5, 1964, Kamanin wrote:

Just yesterday Korolev received an order: no longer work on the "Vostoks." and use the 4 available "Vostoks" to prepare and accomplish a flight of a three-person crew in 1964. This high-level decision took place for two reasons:

1. *The Soyuz will not fly in 1964.*
2. *The Americans, preparing to launch the "Gemini" and "Apollo" ships into space, may already overtake us in 1964.*¹⁰⁰

According to Kamanin, Korolev was not pleased with the order:

*It was the first time that I had seen Korolev in complete bewilderment. He was very distressed at the refusal to continue construction of the "Vostok" and could not see a clear path on how to re-equip the ship for three in such a short time. Several times he repeated: "I don't understand how one can refuse to continue the building of the 'Vostoks.'" . . . It will be impossible to turn a single-seater ship into a three-seater in a few months. . . ."*¹⁰¹

A respected Russian space historian, Georgiy S. Vetrov, later revealed that Korolev agreed to Khrushchev's order to build a three-person version of the Vostok only if Khrushchev would make a more firm commitment to a piloted lunar program. Vetrov added, "This agreement was never spelled out openly, nor was the staff of OKB-1 ever told that 'Khrushchev personally ordered us to do this or that.' That was not the practice at the time."¹⁰² Not surprisingly, Khrushchev's son begs to differ. In an interview in 1996, he confided that:

The three people [in a spacecraft concept] . . . it was Korolev's idea. It was Korolev's idea . . . Korolev, he wanted to be first as long as possible. And he used everything. And

⁹⁹ Salakhutdinov "Once More About Space" One engineer at OKB 1 claims to have actually been present during this phone call. A. S. Kasho, the "lead designer" of three stage variants of the R-7 booster, told OKB 1 Deputy Chief Designer B. Ye. Chertok that he was in Korolev's office when Khrushchev made this phone call. See Chertok *Rakety i lyudi* pp. 181-82.

¹⁰⁰ "The Space Diaries of N. P. Kamanin" (English title) *Novosti kosmonavtiki* 1 (January 1-12, 1997) 76.

¹⁰¹ *Ibid.*

¹⁰² James Harford, *Korolev: How One Man Masterminded the Soviet Drive to Beat America to the Moon* (New York: John Wiley & Sons, 1997) pp. 180-81.

he knew about the American [plans] . . . Khrushchev had never heard about this American program. And he didn't care too much about these things. It was *very* important for *Korolev*, but it was not so important for Khrushchev. And especially such a stupid thing [as] "If you'll do this, I'll give you permission to go to the Moon!"¹⁰³

Other reliable sources also strongly suggest that it was Korolev and not Khrushchev who had originally proposed the idea to modify the Vostok ship.¹⁰⁴ The record is more muddled by evidence that suggests that Korolev was thinking of a three-seated Vostok as early as February 1963.¹⁰⁵

This particular issue of who ordered the three-person Vostok effort has a crucial importance from a historical perspective. This is not only because this new diversionary project essentially derailed the Soviet piloted space effort for two years, but also because it serves as supporting or contradictory evidence for one of the central tenets of historical inquiry into the Soviet space program for the past thirty years: that Khrushchev was personally involved in distorting the "normal" evolution of the Soviet space program to extract short-term political gain. While it seems more than likely that someone in the Communist Party or government ordered Korolev to convert the single-seated Vostok into a three-seated ship to beat Gemini, the evidence that it was Khrushchev does not completely hold up to in-depth study. Perhaps it was Leonid I. Brezhnev, the Secretary of the Central Committee for Defense Industries and Space, or perhaps it was someone lower on the ladder of power. Ultimately, we may never probably know until the minutes of Central Committee or Presidium meetings are declassified.¹⁰⁶

From Kamanin's diaries, it is clear that Korolev was not too happy with the idea, at least in the initial days after the decision. But it is easy to forget that Korolev himself had an almost pathological desire to be first—to beat the Americans at all cost. It would not have been contradictory to his personality to pursue the three-cosmonaut-in-a-Vostok plan simply to upstage the early Gemini missions. He was, after all, strongly committed to flying an additional four Vostok spaceships in 1964, all of which would tenuously extend to the limit the capabilities of a vehicle that was fast becoming obsolete. The three-cosmonaut-in-a-Vostok idea may have been a challenging technical problem, but in terms of vision and planning, it was not so much different from some of the technological changes on his four "extended Vostok" missions planned for 1964. Ultimately, the proposal to usurp Gemini proved to be one of the most deleterious decisions in the early Soviet piloted space program. It completely ignored the natural progression of space vehicles and inserted a diversionary program that would ultimately result in little qualitative gain for Korolev's grand vision of an expansive space program. For the Soviets, the "space race" had degenerated into a little more than a circus act of one-upmanship.

With the order to move ahead with the interim program, Korolev dropped his earlier plans to fly four "extended Vostok" missions in 1964. Instead, OKB-1 would use the same four vehicles for the new politically motivated effort. The Soyuz program was put on the backburner. To present the image that the Soviet Union was engaging in a new and qualitative leap in space exploration, Soviet officials named the new project Voskhod ("Sunrise"). If the publicity machine in the USSR worked as well as it had in previous years, no one would guess that the Voskhod spacecraft was simply a modified Vostok packed with three cosmonauts. Officials

¹⁰³ Telephone interview Sergey Nikitich Khrushchev with the author October 10 1996

¹⁰⁴ See for example Colovanov *Korolev* p 731 Interestingly enough Military Industrial Commission Chairman L V Smirnov had rejected Korolev's plan for the series of "extended Vostok" missions on February 1 1964 just three days before the order to build a three man ship. Quite likely the two events were connected

¹⁰⁵ See for example Romanov *Korolev* pp 454-57

¹⁰⁶ Kamanin suggests in his diary entry for March 21 1964 that the "initiators" of the three seated Vostok were D F Ustinov L V Smirnov S P Korolev and M V Keldysh See Kamanin *Skrytyy kosmos* 1964-1966 p 30

discussed the proposal at a meeting of the Military-Industrial Commission on March 13, 1964, and Chairman Smirnov signed a decree (no. 59) the same day, which called for the creation of four three-seated spaceships based on the Vostok. The commission set the first piloted launch for the first half of August 1964, which was less than five months' time.¹⁰⁷

In the weeks after the Military-Industrial Commission decree, Korolev added or was forced to add a second diversionary mission before moving on to Soyuz: a flight to carry out an EVA. The decision was again evidently motivated by impulses to prevent the U.S. space program from racing ahead of the Soviets. As early as March 1963, NASA had established guidelines for performing spacewalks during the Gemini program. Through the remaining part of the year, the Manned Spacecraft Center in Houston evaluated various proposals for an EVA life support package. By January 1964, officials at the Houston center had completed the final details of the plan. Gemini IV, then scheduled for February 1965, would have the crew pilot open the hatch and stand up for a short period." Once again, the Vostok spacecraft presented the most realistic vehicle for performing a Soviet EVA mission, in a modified variant known as *Vykhod* ("Exit"). The design would be based in part on the preliminary studies on EVA by animals in the original "extended Vostok" mission plans.

On April 13, 1964, the Central Committee of the Communist Party and the USSR Council of Ministers issued a decree fully approving both the Voskhod and Vykhod missions. The decree provided the green light to build two "new" classes of spacecraft in support of the Voskhod program, both derived from the old 3KA Vostok spacecraft that had carried all six Soviet cosmonauts into orbit from 1961 to 1963. The "new" ships were: the 3KV spacecraft for a crew of three cosmonauts (Voskhod) and the 3KD spacecraft for a crew of two cosmonauts (Vykhod), which would allow EVA in Earth orbit.¹⁰⁹ Specifically, the Central Committee and the Council of Ministers sanctioned funding for the manufacture and launch of five of the new vehicles, three for Voskhod and two for Vykhod. The program itself would be carried out in two stages: the launch of a dog into Earth orbit to test out each model, followed by a second flight with an actual crew. Presumably, the fifth vehicle would remain as a spare. With the decree on April 13, 1964, Vostok was irrevocably over, and Voskhod had begun.

Moving to a Standstill

On January 25, 1962, NASA formally approved the development of a three-stage booster, designated the Saturn C-5, for use in the Apollo lunar landing missions.¹¹⁰ By August, all the primary contracts had been awarded for the giant vehicle. The Saturn V (as it was renamed in February 1963) would have a total length of 111 meters and a liftoff thrust of 3,404 tons. Unlike the baseline version of the N1, engineers at the Marshall Space Flight Center opted to use high-energy cryogenic propellants in the upper stages of the Saturn V, taking advantage of the valuable experience gained from the development of the Centaur high-energy upper stage. The Saturn V would have an eventual capability to orbit a 130-ton payload to a 195-kilometer Earth orbit, far in excess of the N1. The effort was supported by a vast infrastructure spread across the

¹⁰⁷ I. Marinin, "The First Civilian Cosmonauts" (English title), *Nouostr kosmonavtika* 12-13 (June 3-30, 1996): 81-87. Kamanin, *Skrytyy kosmos 1964-1966*, p. 32. According to the VPK decree, the first ship would be ready at the launch site by June 15, 1964, the second by June 1964, and the third and fourth by July 1964. The contents of this decree were based on an OKB-1 document dated February 8, 1964, titled "On Preparations for a Three-Seater Satellite-Ship." In the document, Korolev noted that such a mission would "maintain the preeminence of the Soviet Union in the development of space and rocket technology"

¹⁰⁸ David Baker, *The History of Manned Spaceflight* (New York: Crown Publishers, 1985), p. 184

¹⁰⁹ Semenov, ed., *Raketno-Kosmicheskaya Korporatsiya*, pp. 116, 636. Another source says that the Voskhod decree was issued on June 14, 1964. See Chertok, *Rakety i lyudi*, p. 242

¹¹⁰ Ezell, *NASA Historical Data Book, Volume II*, p. 61.

United States, with hundreds of subcontractors and a management philosophy that was unparalleled in producing results. With a budget of which Soviet engineers could only dream, technology that was beyond the reach of Soviet industry, and management techniques that fostered creativity and responsibility, the Saturn V program was the living antithesis of the N1 program.

The Soviet counterpart program was bestowed official sanction by the Soviet Party and government in September 1962, after several years of preliminary research on heavy-lift boosters. That decision allowed OKB-1 engineers to put together the design documentation for the N1 in preparation for its manufacture. A good portion of the work at the time was focused on developing the engines for the first three stages of the N1. The effort, earlier beset by personal battles, was plagued by technical obstacles. With Clushko ejected from the program, the onus of designing the engines fell on the shoulders of General Designer Nikolay D. Kuznetsov, the head of OKB-276 based at Kuybyshev. By the end of 1962, Korolev and Kuznetsov had finalized the layout of engines for the stages of the N1, as follows:

Stage	Engine Type	Number		Thrust (sea level of vacuum)
Stage I	NK-15	24	x	153.4 tons thrust (sea level)
Stage II	NK-15V	8	x	178.6 tons thrust (vacuum)
Stage III	NK-21	4	x	41.0 tons thrust (vacuum)

Korolev had sent clarifications for the original technical assignment for designing the NK-15V and NK-21 engines to Kuznetsov earlier in July 1962.¹¹¹ Although Kuznetsov had little experience with developing liquid-propellant rocket engines, there was a fairly substantial database of research into which his engineers tapped. The design schemes of all three of the N1 engines had antecedents in the two engines developed for Korolev's GR-1 orbital bombardment system, as shown here:

Original Engine	Use on CR-1	Thrust	Changes to:	Engine	New Use on N1	Thrust
NK-9	Stage I	c. 40 tons	Scaled-up version	NK-15	Stage I	c. 150 tons (sea level)
			Altitude version of scaled-up version	NK-15V	Stage II	c. 180 tons (vacuum)
NK-9V	Stage II	c. 40 tons	Similar	NK-21	Stage III	c. 40 tons (vacuum)
			Similar	NK-19	Stage IV	c. 40 tons (vacuum)"

111. Igor Afanasyev. "N1 Absolutely Secret. Part II" (English title). Krylya rodiny no. 10 (October 1993) 1-4; V. P. Mishin. "Why Didn't We Fly to the Moon?" (English title), Znanrye tekhnike, seriya kosmonavtika, astronomiya no. 12 (December 1990) 3-43; V. S. Anisimov, T. C. Laceyfield, and J. Andrews. "Evolution of the NK-33 and NK-43 Reusable LOX/Kerosene Engines," presented at the 33rd AIAA/ASME/SAE/ASEE Joint Propulsion Conference & Exhibit, Seattle, WA, July 6-9, 1997; Mikhail Rudenko. "Space Bulletin: 25 Years From the Landing of American Astronauts on the Moon" (English title). *Vozdushniy transport* 29 (1994): 8-9.

112. Anisimov, Laceyfield, and Andrews, "Evolution of the NK-33 and NK-43 "

The original NK-9 and NK-9V engines themselves were distinguished by the fact that the latter was merely a high-altitude version of the former. The NK-9 had also been offered as the first-stage engine for an alternative version of Korolev's R-9 ICBM, but it was rejected in favor of a Glushko engine.

Technical problems plagued the program throughout the early years. During the first eleven months of 1962, there were fifty-seven ground firings of the NK-9 engine with a new gas generator. Of these, twenty-six were outright failures, twenty-three displayed high-frequency oscillations, and only eight were completely successful. The results of these tests no doubt had an influence on the improved NK-15 engine, although participants later claimed the engineers of Kuznetsov and Korolev were remarkably resourceful in overcoming obstacles:

At the stage of design-related research on the development of sustainer engines in 1962 and 1963, despite the lack of any experience and despite its being far removed from the test stands, N. Kuznetsov's OKB solved problems associated with the fundamental functioning of the engines and their assemblies.¹¹³

Throughout 1963, during a period of intense "optimization" toward the N1 booster design, engineers from Kuznetsov's organization remained permanently stationed at OKB-1 to ensure that the changes in booster design were taken into account in the design of the NK-15 engines. Intriguingly enough, there seems to have been a collaboration of sorts between the design bureaus of Kuznetsov and Glushko, certainly rival organizations at the time. Glushko, based at Khimki, was then developing the RD-253 for Chelomey's UR-500 missile—an engine that he had originally offered to Korolev for the N1. Given that the RD-253 shared a number of design characteristics with the NK-15, engineers under Kuznetsov "were familiar with all the basic documentation on the Khimki engines and often traveled to Glushko's firm to exchange information."¹⁴ By April 1964, Kuznetsov's engineers were able to build and display a full-size, nonfunctional mock-up of the NK-15 in their assembly shop.¹⁵

The baseline design of the N1 used only liquid oxygen (LOX)-kerosene engines. Later models were to use LOX-liquid hydrogen and perhaps even nuclear engines to significantly increase payload capability from the modest seventy-five tons in the first N1 model. As per the original tactical-technical assignment signed by engine designers in 1961, Isayev's OKB-2 and Lyulka's OKB-165 were to develop high-performance LOX-liquid hydrogen engines for the upper stages of the N1. Korolev also commenced planning for the use of such engines on other more modest launch vehicles, such as the GR-1 and the 8K78; in short, OKB-1 believed that the use of such propellants would have to be an integral part of any future Soviet space program. By April 1964, Korolev had also invited Kuznetsov at Kuybyshev to begin developing a series of LOX-liquid hydrogen engines based on the NK-9, despite the severe load of having to design all the more traditional N1 engines.¹⁶

All this enthusiasm on Korolev's part could not save the overall effort from near oblivion. Two factors played deleterious roles: the lack of a liquid hydrogen production industry in the Soviet Union and the absence of testing grounds and facilities for the static firing of these engines. Korolev's almost-desperate letters from the early 1960s to the military and government

¹¹³ R. Dolgopyatov, B. Dorofeyev, and S. Kryukov, "At the Reader's Request: The N1 Project" (English title) *Aviatsiya i kosmonavtika* no. 9 (September 1992): 34–37.

¹¹⁴ Igor Afanasyev, "N1: Absolutely Secret Part III" (in Russian) *Krylya rodiny* no. 11 (November 1993): 4–5.

¹¹⁵ Afanasyev, "N1: Absolutely Secret Part II," Rudenko, "Space Bulletin: 25 Years From the Landing." The building of the model had apparently begun in March 1963.

¹¹⁶ These OKB 276 engines would be developed in three stages, with progressively powerful engines of forty-five, sixty, and eighty tons.

remained more or less ignored as both OKB-2 and OKB-165 were still drawing up designs by the time that NASA's Centaur was actually flying on top of the Atlas booster. Work on building static testing stands for LOX-liquid hydrogen engines did not even begin until 1965, when construction began at the vast NII-229 test facility in Zagorsk.¹¹⁷

Nuclear, electrical, and electrical-nuclear engines for the NI were also the focus of much effort at OKB-1. In March and April 1963, the Central Committee and the Military-Industrial Commission hosted discussions on such engines—consultations that led to the establishment of an interdepartmental commission to oversee work on electric and nuclear engines.¹¹⁸ By this time, under the leadership of Deputy Chief Designer Mikhail V. Melnikov, OKB-1, together with researchers from the Physical-Power Institute at Obninsk (which was under the Academy of Sciences) and Keldysh's NII-1, had examined several different approaches of converting the heat energy from a nuclear reactor into electrical energy. What they chose eventually was a so-called thermo-emission converter (often called thermionic) reactor, which scientists believed had significant advantages over other schemes, such as steam turbines or gas turbines. In 1962, Melnikov completed his initial studies with the issuance of a document on applications of nuclear engines for a heavy interplanetary spacecraft.¹¹⁹ As with the liquid hydrogen program, the nuclear engine effort never received the funding required for intensive development. It was only in August 1965 that Korolev signed the draft plan for a low-thrust nuclear electric-rocket engine, the YaERD-2200, designed specifically for use on piloted interplanetary spaceships. The 8.3-kilogram thrust engine had a dual block scheme, with each block generating 2,200 kilowatts. Unfortunately, given the limited support and funding, few plants were willing to take on the work to develop such engines. One of those that did was Chief Designer Kosberg's Design Bureau of Chemical Automation at Voronezh, which began work in 1965 on a more powerful nuclear engine with a thrust of forty tons.¹²⁰ With the generally slow pace of the research, neither engine was expected to come on line before the end of the decade.

The funding problem, compounded by institutional and technical obstacles, cut across almost every aspect of the NI program and its GR-1 testbed precursor. By the end of 1962, OKB-1 planned to fly the first GR-1 missile from Tyura-Tam by the third quarter of 1963. Within weeks, this completely unrealistic deadline was pushed back as a variety of factors all resulted in delays. The military, lukewarm early on to the use of the GR-1, was even more indifferent to it by 1963. Despite pressure from OKB-1, the Strategic Missile Forces—more specifically its Chief Directorate of Reactive Armaments—refused to agree to a common tactical-technical assignment for the missile, naturally delaying its design. One of the most challenging problems was the development by OKB-1 of a third-stage engine that would be capable of operating in vacuum. A similar engine was also projected for use on the NI, but if its early development record was any indication, there was little to be optimistic about: there was failure after failure during ground tests in 1963.

117. NII-229 was the primary static testing facility for liquid-propellant engines in the Soviet Union. All high-thrust engines beginning with the RD-100 for the R-1 in the late 1940s had been tested at this location. It was originally subordinate to NII-88, but it separated in August 1956 at the same time as OKB-1.

118. The commission, whose chairman was Yu. I. Danilov, included representatives from OKB-1, NII-1, NII-88, OKB-670, TsAGI, TsIAM, OKB-456, IAE, VNII EM, MAI, and OKB-586.

119. Semenov, ed., *Raketno-Kosmicheskaya Korporatsiya*, p. 409; S. P. Umanskiy, "Manned Flight to Mars" (English title), *Zemlya i usemennaya* no. 6 (November–December 1994): 22–32. The document was entitled "Materials for a YaERD for Heavy Interplanetary Ships." "YaERD" is the Russian abbreviation for "nuclear-electric rocket engine."

120. The August 1965 draft plan, drawn up in coordination with the Physical-Power Institute at Obninsk, also included a design for a forty-ton thrust nuclear electric-rocket engine. It was probably the same engine proposed by the Design Bureau of Chemical Automation. See also Semenov, ed., *Raketno-Kosmicheskaya Korporatsiya*, pp. 408–09.

Progress with the GR-I was critical to maintaining the original NI schedule, but the problems with the NI were even more severe. The primary bottleneck was money—a factor compounded by economic depression in the region where the most intense activity on the booster was carried out: Kuybyshev, the location of Kuznetsov's OKB-276, and the nearby Progress Plant, the primary manufacturing site for the NI. Partly because of general economic mismanagement and partly because of the downturn in the aviation industry stemming from Khrushchev's abrupt about-turn in favor of missiles, plants and subcontractors in the region were unable to cope with Korolev's orders. Korolev personally appealed to several high-level Communist Party administrators at Kuybyshev to offer all the assistance they could.¹²¹ As a result of their actions, as many as twenty-eight different industrial firms located in and around Kuybyshev were brought into the NI program. Most of these institutes, plants, or design bureaus had earlier been involved in producing parts for aircraft but had lost all their orders and thus means of existence in recent years.¹²² OKB-276 had extremely poor engine testing facilities, with certainly nothing to allow it to test-fire 150-ton-thrust engines—a factor that was no doubt an issue of concern when Glushko, with his much better resources, pulled out of the program. An OKB-I engineer later remembered:

Kuznetsou did not have the necessary facilities or test stands. This would result in great losses of time. Korolev wrote "stern" letters to Kuznetsov and simultaneously appealed to the then-secretary of the oblast committee V. I. Vorotnikov, to help Nikolay Dmitriyevich [Kuznetsov]. A third letter immediately went to V. E. Dymshits of the Council of Ministers: "The people in Kuybyshev are having a hard time. Help them!" That's how Sergey Pavlovich strove to "press all the buttons."¹²³

The NI program literally became the provider for the entire Kuybyshev region, although it still remained a state secret. In fact, an individual employee at a particular plant would quite possibly have been unaware of exactly where his or her particular part was ultimately destined.

The management of the NI program—certainly the most ambitious "civilian" Soviet space project of its time—was mired in the gridlock symptomatic of the poor performance of the Soviet civilian economy. Thus, it never mattered whether a particular production order was supposed to be carried out; the job might never get done were it not for some personal favor or "unconventional" input. Deadlines often depended on a personal visit, a letter, or a telephone call from a well-placed individual, not on a signed and sealed document. This type of management naturally resulted in a chaotic system in which parts were often delivered months later or in some cases not at all. There was no "single plan of action" to coordinate the hundreds of plants and research institutions. Because the military was not particularly interested in the project, by default, many of the subcontractors were from the "civilian" economy. OKB-I First Deputy Chief Designer Mishin, one of the leading architects of the entire program, recalled later that:

121. Among those to whom Korolev appealed was V. Ya. Litvinov, the then-chairman of the Kuybyshev Council of National Economy (Kuybyshev Sovnarkhoz), the local economic administration entity. Until 1962, Litvinov had served as the director of the Progress Plant, and thus he was well acquainted with the rocketry and space industry. The Progress Plant (also known as Plant No. 1) had been manufacturing R-7-based boosters since 1959. Others at Kuybyshev who were instrumental in offering help to Korolev were V. Orlov and V. I. Vorotnikov, both secretaries of the Communist Party's Regional Committee. See Sergey Leskov, "How We Didn't Get to the Moon" (English title), *Izvestiya*, August 18, 1989, p. 3; Mishin, "Why Didn't We Fly to the Moon?"

122. These "firms" included the Institute of Aviation, Plant Nos. 24, 207, 276, 305, 525, and 454, OKB-I Branch No. 3, the Progress Plant, and OKB-276.

123. Col. M. Rebrov, "But Things Were Like That—Top Secret. The Painful Fortune of the NI Project" (English title), *Krasnaya zvezda*, January 13, 1990, p. 4.

The NI was being made by 500 organizations in 26 departments. Of these, only nine fell within the jurisdiction of the Military-Industrial Commission. The rest had to be begged for. Resolutions from the Council of Ministers did not help at all: the tasks were just outside their competence and delivery schedules were not met . . . we failed to agree with minister after minister as they made the rounds, and often it ended in checkmate.¹²⁴

The enormous problems related to management and finances did not hinder a remarkably productive period of design through 1963 and up to the first quarter of 1964, when the primary design documentation was prepared under Deputy Chief Designer Sergey O. Okhapkin. His engineers addressed and resolved significant problems related to the manufacture of large-scale welded propellant containers, thermal protection for tanks maintained at cryogenic temperatures, the use of new metallic and nonmetallic materials, the welding of large and thick materials, the assembly of large-scale compartments, and the development of means for assembling and disassembling large sections of the tail and payload compartments. Specific groups were established within the design bureau to complete studies addressing flight ballistics, the computation of load variances during flight, the issue of stability of movement, the pneumo-hydraulic and thermal process associated with ascent to orbit, and the design of electrical and pneumo-hydraulic connections between the stages. One of the most challenging areas was the development of armature—that is, pipelines, umbilicals, valves, and so on—which necessitated a very high degree of precision until then unknown to the Soviet rocketry industry.¹²⁵

The luckless job of overseeing the design of the NI fell on the shoulders of OKB-1 Deputy Chief Designer Sergey S. Kryukov, who was fifty-five years old in 1963. A tall, bespectacled, and quiet man who was outwardly unemotional. Kryukov had graduated from the Moscow Higher Technical School after World War II before being sent to Germany as part of the A-4 recovery teams. His technical and managerial expertise made a good impression on Korolev through the years as he contributed to all ballistic missile projects at OKB-1, in particular the famous R-7. In 1961, Korolev appointed him a deputy chief designer, putting him in league with the so-called "high guard" of the design bureau—that is, those at the top levels of decision-making. Along with Korolev, Mishin, Bushuyev, Okhapkin, and Chertok, he was one of the most powerful men in the organization, as evidenced by his leading role not only in the NI program, but also in the Soyuz project, the R-9 ICBM effort, and a variety of classified military programs. His very existence, not to



OKB-1 Deputy Chief Designer Sergey Kryukov was perhaps the *leading architect* of the NI Moon rocket. He oversaw the *initial design layout* of the grant booster during the early 1960s (files of Peter Gorin)

¹²⁴ A. Tarasov "Missions in Dreams and Reality" (English title) *Prauda*, October 20, 1989, p. 4.

¹²⁵ S. Kryukov "The Brilliance and Eclipse of the Lunar Program" (English title) *Nauka i zhizn*, no. 4 (April 1994), 81-85. Semenov, ed. *Raketno-Kosmicheskaya Korporatsiya*, p. 251. The work on new precision criteria with consideration to the specific loads on the rocket was headed by Deputy Chief Designer S. O. Okhapkin. The work on the armature was carried out under A. N. Voltsifer at Department No. 41. The ballistics work was led by S. S. Lavrov and the computations of load variances was led by V. F. Gladkiy.

mention his significant contribution to the overall direction of the Soviet human space program, was a state secret until the early 1990s.¹²⁶ Kryukov's official duties were to oversee "design and computational-theoretical" work on the N1, but he effectively led the team that designed the rocket in its initial stages.

Kryukov, along with Korolev and Mishin, participated in one of the most fatal decisions of the N1 program. As early as March 1963, they were considering the elimination of ground testing of the complete first stage with its full complement of twenty-four engines. This particular issue has been clouded in recent years by conflicting information; some argue that the decision to omit first-stage static testing was imposed by space program leaders, while others maintain it was a purely internal decision at OKB-1. Both sides agreed that it was taken primarily because of a lack of funds. Large amounts of money would be required to build giant static test stands for the completed first stage, and no such facility then existed in the Soviet Union. A second factor was time. Even if never overtly stated as such, the N1 booster came to be a direct competitor to the Saturn V. Having a payload capability of seventy-five tons (compared to the Saturn V's 130 tons) was embarrassing enough, but introducing the booster much later than the Saturn V was simply unacceptable to Korolev. Vladimir V. Vakhnichenko, a senior engineer working on the N1, recalled almost three decades later:

In discussing the fate of the N1, it is impossible to be silent about the fact that, in the creation of the launcher, the unwritten law of rocket building was violated: that the bugs in the burn of the rocket stages must be worked out on the test stand. In order to save time and money, it was decided not to construct a stand for the first stage, which meant that the crucial final tests would be shifted to the flight-test stage. The underestimation of the scale factor — the immense size of the launch vehicle, each launch of which was an event in the life of the country — played a fatal role in the erroneousness of this decision. Earlier when smaller launch vehicles and military missiles were being developed, many ground-test "flaws" would be eliminated during flight-testing. And it was no big deal that for some rockets it was necessary to carry out 40–50 launchings before they "learned" to fly. But that approach was unsuitable for the N1.¹²⁷

Korolev was even unwilling to launch an N1 with simply a live first stage and dummy upper stages, preferring "all-up" testing, with flight-ready versions of *all* the stages. This was a recipe for disaster because the first stage with its complement of twenty-four engines would not be tested a single time before flight. "If the rocket takes off with dummies instead of the second and third stages, how I can I show my face when I get out of the bunker?" he evidently used to tell his associates.¹²⁸ In one sense, the decision to move ahead with "all-up" testing for the N1 was not as risky a decision as might seem in retrospect. In 1963, Korolev had one big ace up his sleeve: the GR-1. By the time that a fully stacked N1 was on the pad, OKB-1 expected to have finished testing the orbital bombardment system, thus reducing the risk of failure on the upper stages of the N1. That, of course, still left the most critical and weakest link of all, the first stage, open to possible catastrophe.

In the hope of compensating for the decision to dispense with first-stage ground testing in concurrence with "all-up" testing, OKB-1 adopted two measures. One of them was the use

¹²⁶ Semenov ed *Raketno-Kosmicheskaya Korporatsiya* p 252 Golovanov Korolev, pp 474–75 Mozhgorin *et al* eds *Dorogi v kosmos I*, pp 101–09 Note that Kryukov himself claims that he was appointed a deputy chief designer "in 1959–1960" Golovanov states that it was in 1961

¹²⁷ Rebrov "But Things Were Like That—Top Secret "

¹²⁸ Leskov "How We Didn't Get to the Moon "

of the KORD system, which was designed to shut off particular engines in the circle of twenty-four if the slightest malfunction was detected. The control system was highly complex, difficult to design, and pushed the limits of Soviet computer technology, but OKB-1, in cooperation with Korolev's old friend Chief Designer Pilyugin, doggedly pursued the idea. That the system was reactive rather than predictive does not seem to have given pause to either Korolev or Pilyugin, although there was criticism from many other quarters. The second compensatory measure was to "extrapolate" results from the static firings of the eight-engine second stage to the similar but larger first stage. There was a weak link even in these "extrapolations." In a decision taken sometime later, OKB-1 and OKB-276 agreed not to test each and every NK-15 engine on the ground; instead, a statistical program was devised in which a group of six engines would be selected randomly from a batch of manufactured units. Of the six, two would be selected randomly and tested thoroughly at a static stand; if they passed the tests, the remaining four would be cleared for flight." Such was the price of the lack of time and money.

Delays also plagued the design of the launch complex for the N1. In December 1962, OKB-1 and the CSKB SpetsMash signed "The Initial Data and Primary Technical Requirements for Designing the Launch Complex for the N1 Rocket" with the State Committee for Defense Technology. Progress on this issue was bogged down, however, in an intense conflict between Korolev and Chief Designer Barmin over launch complex design. It took a year to resolve the matter; it was only on November 13, 1963, that the Supreme Council of the National Economy formally approved the "interdepartmental" schedule for work on the design documentation for construction of the complex, enumerating in detail the technical and material needs for the job. A governmental resolution a month later, on December 24, was a promise to ensure that this goal was indeed achieved on time. However, as was typical, the Ministry of Defense, the "owners" of the Tyura-Tam range, refused to follow up on the governmental decree: CSKB SpetsMash, the primary launch complex design organization, was left with little money to do anything. By this time, engineers and architects had marked out a vast area at the range, comprising sites 110, 112, and 113, for all N1 operations. Two launch complexes would be built at site 110, the giant assembly building and fueling area at site 112, and the residential zone and welding facilities at site 113. Actual construction at the sites began in 1964 under the direction of Chief Designer Barmin, but it was at a snail's pace. The Ministry of Defense allocation for launch complex construction for the year 1965 was one-third of what was requested."

Funding for the space program had always fallen short of what was requested by the leading chief designers, but one factor in the severe crunch may have been Chelomey's rising dominance within the missile and space programs. Although his organization, OKB-52, had little to show in terms of actual accomplishments by 1963 or 1964, the scope of work at the Reutov-based organization was breathtaking. With its several branches spread out across the Moscow area, it was engaged in the development of ICBMs, orbital bombardment systems, space launch vehicles, radar ocean reconnaissance satellites, anti-satellites, various models of piloted and automated spaceplanes, naval anti-ship cruise missiles, and a nationwide ballistic missile defense system.

Chelomey's first entry into the space program came in late 1963, although, in an ironic twist, he needed Korolev's assistance to facilitate it. By the end of 1962, it was clear that the first launch of his coveted UR-200 ICBM would be delayed past the original deadline. Tests to qualify it as a

129. Kryukov. "The Brilliance and Eclipse of the Lunar Program."

130. Semenov, ed., *Raketno-Kosmicheskaya Korporatsiya*, p. 251; † A. Marinin and S. Kh. Shamsutdinov, "Soviet Programs for Piloted Flight to the Moon" (English title). *Zemlya i uselennaya* no. 5 (September-October 1993): 77-85

space launch vehicle would take even longer. Chelomey's first space vehicle, the IS anti-satellite, would in the meantime be ready for a first test launch, but without the booster needed to put it into orbit. On January 20, 1963, Chelomey, escorted by a large entourage, paid an official visit to see Korolev at Kaliningrad. An agreement was hammered out whereby OKB-1 would provide a number of R-7-based boosters for launches of the early

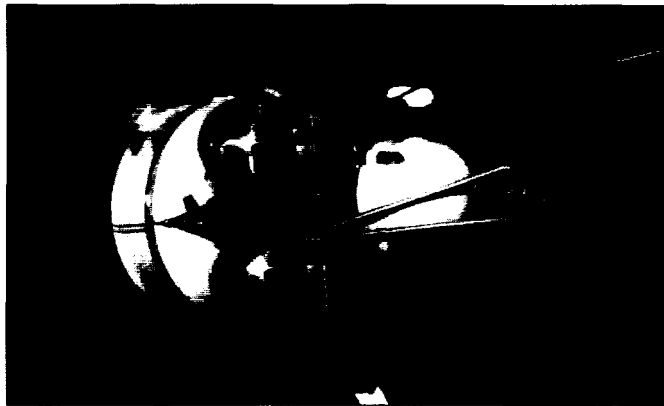

This is a model of the first space vehicle developed by the Chelomey design bureau, the "IS" anti-satellite spacecraft. Upon launch in November 1963 the satellite was named Polet 1 (copyright Dietrich Haeseler)

Chelomey satellites in the "IS" and "US" series until the UR-200 came on line. The visit itself was remarkably amiable, and the two were polite and friendly with each other in contrast to the dismal relationship between Korolev and Glushko. As Sergey N. Khrushchev later recalled, "Although their rivalry [in space] was growing, their personal relationship remained friendly. This was not insignificant when one considers the complexity of their characters." There was a little conversation on the NI, but Korolev did not go into great detail on the project in front of his primary competitor. Meanwhile, Chelomey neither conveyed his grave doubts on the NI program, nor did he express any curiosity about its current status; to do so would have been indiscreet in the given circumstances. Through the ensuing years, despite the intense professional competition, both remained on friendly terms whenever they met at government receptions, meetings, or the launch range.

Using a variant of the basic R-7 ICBM, named the 11A59, Chelomey launched his first "IS" satellite into orbit on November 1, 1963, from site 1 at Tyura-Tam. The general designer could not resist being different from the other space designers. Unlike all other generic military satellites, which were named "Kosmos," Chelomey picked the name *Polet* ("Flight") for his little vehicle. The spacecraft became the first-ever satellite to maneuver in space by changing orbits, a crucial capability needed for anti-satellite operations.¹³² Just two days after the Polet-1 launch, which caused quite a stir among Western observers, Chelomey launched the secret UR-200 ICBM on its first test flight with only a live first stage. It was the first visible manifestation of Chelomey's emerging dominance in the space and missile programs, and coincidentally or not, it came during the most difficult financial time for Korolev.

While Chelomey's rising star may have played a role in the funding problems for the NI, clearly the most important factor in the equation was the indifferent attitude of OKB-1's

¹³¹ A long description of this meeting between Korolev and Chelomey is covered in Sergey Khrushchev *Nikita Khrushchev krizisy i rakety uzglyad iznutri* tom 2 (Moscow: Novosti, 1994) pp 441-43. See also Rudenko "Space Bulletin: 25 Years From the Landing."

¹³² A second such satellite, Polet 2, was launched in April 1964. For descriptions of the Polet-1 and Polet 2 missions, see V. Polyachenko "In Orbit—Polyot" (English title) *Aviatsiya i kosmonavtika* no. 12 (December 1992): 36-37; Mikhail Rudenko "Designer Chelomey's Rocket Planes" (English title) *Vozdushnyy transport* 51 (1995): 7-8; Khrushchev *Nikita Khrushchev* tom 2 pp 465-66; Asif A. Siddiqi "The Soviet Co-Orbital Antisatellite System: A Synopsis," *Journal of the British Interplanetary Society* 50 (June 1997): 225-40.

CHALLENGE TO APOLLO

primary financier and client, the Ministry of Defense. The original 1962 decree approving the N-1's development had tasked the Ministry of Defense to formulate a set of missions for the use of new spacecraft for exclusively military purposes. But the powerful NI simply did not "fit into then-existing notions of defense" of the Soviet Union." As one Soviet journalist later wrote:

... the work [on the N1] was influenced by the nonavailability of resources and financing. It was clear there was an absence of interest from the main client of rocket-space technical issues—the Ministry of Defense, because the objectives and the payloads for the N1 had not been specified.¹³⁴

The disinterest from the military was catastrophic for the NI program as a whole. As the primary financier of the NI project, the Ministry of Defense refused to let loose its purse strings, being more interested in achieving strategic parity with the United States. In 1964, OKB-1 was allocated only 23 million rubles of the 45 million requested. OKB-276 received 20 million even though 50 million was needed, and the Kuybyshev Council of National Economy was apportioned 9 out of the 23 million rubles requested. Through all this, under the supervision of Kryukov and Okhapkin, OKB-1 finished the preparation of the "primary set" of design documentation for the NI in March 1964, thus ready to move into the actual manufacturing of flight articles." But with money completely drained, by early 1964, the unthinkable had happened: work on the NI was at a complete standstill as plants, institutes, and design bureaus ceased work on the vast program, leaving idle all that had been built. Faced with a serious situation, Korolev, in effect, took the problem out of the hands of the Ministry of Defense. If the military would not define a payload for the NI, then he himself would.

The Decision to Go to the Moon

Piloted exploration of the Moon had been discussed seriously in the early 1960s at the top levels of the Soviet leadership, but only as it concerned circumlunar missions. By 1963, Chelomey was exploring the possibility of sending his Raketoplan with crews around the Moon, while Korolev had received full-scale approval in December 1963 with his 7K-9K-1 IK Soyuz proposal. Both efforts suffered delays that stemmed more from technical considerations rather than institutional factors. Originally, Chelomey had considered a wingless Raketoplan capable of a ballistic reentry from lunar distances, but such a profile would impose too high thermal stresses on the returning spacecraft, in addition to severe gravitational loads on a potential crew. In late 1963, he dropped all his ballistic circumlunar plans and adopted a "new" plan, which allowed for a guided reentry into the atmosphere." Unlike the Vostok's spherical return capsule, he chose to adopt a design that had originated elsewhere—in the United States. Kept abreast of NASA's Gemini project, it seems that Chelomey had appropriated its design into a Soviet version of the vehicle, named the LK-1 ("Lunar Ship No. 1"). Khrushchev's son Sergey, who was an engineer at OKB-52 at the time, later recalled. "I think he used the Gemini idea, because he began to speak about this after [Gemini] was published."¹³⁷ Original or copied, the LK-1 was to be Chelomey's grand entry into the Soviet piloted space program, by sending the first Soviet cosmonauts around the Moon.

¹³³ C. Vetrov, "The Difficult Fate of the NI Rocket" (English title), *Nauka i zhizn* no. 5 (May 1994): 20–27.

¹³⁴ Afanasyev, "NI: Absolutely Secret. Part II," p. 3.

¹³⁵ Kryukov, "The Brilliance and Eclipse of the Lunar Program", Dolgopyatov, Dorofeyev, and Kryukov. "At the Reader's Request. The NI Project."

¹³⁶ Interview. Cerbert Aleksandrovich Yefremov with the author. March 3, 1997

¹³⁷ Khrushchev interview, October 10, 1996

Chelomey pursued the idea with great vigor and spoke personally to Khrushchev about it during the summer of 1964 while the Soviet leader conducted an official visit to his design bureau.¹³⁸ Although the topic of the meeting was ICBMs, Khrushchev apparently sanctioned Chelomey's LK-1 idea at the time, another in a long line of new projects for the general designer. An official decree on the program was apparently issued on May 22, 1964. The same governmental decision also formally terminated all further work on Chelomey's ambitious Martian Kosmoplan project and the circumlunar Raketoplan.¹³⁹ After close to five years of pursuing a pipe dream, Chelomey was forced to admit that his ideas were a little ahead of his time. While he would vigorously continue wide-ranging efforts to develop new spaceplanes, conceptions of lunar and interplanetary flight by such vehicles receded out of view. The focus would be on competing with Apollo.

Compared with the Apollo program, Soviet piloted circumlunar projects were a poor second. Even now, it is difficult to rationalize the persistence with which designers such as Korolev and Chelomey pursued these efforts. If public accolades formed the primary objective of a circumlunar effort, what gain could be extracted in the face of Apollo, which would actually land Americans on the Moon? The only possible explanation is that the Soviets simply never believed that the U.S. lunar landing effort was serious enough to warrant a response. This mode of thinking is, in fact, borne out by the unusually indifferent response to Apollo during the 1961-63 period. The primary NI missions were either for defense or for piloted Martian flights: while the former was never defined, the latter was pursued with some vigor up to about mid-1963, when there was a major shift in thinking at OKB-1.¹⁴⁰

The Central Committee of the Communist Party, in the persons of Khrushchev and Frol R. Kozlov, had no serious cause to feel threatened by the murmurs of activity from NASA. By the end of 1963, the Soviet Union continued to maintain its undisputed lead in space exploration, springing one "first in space" after another at a continually shocked American audience. The Central Committee's primary concern, as with the military, was achieving strategic parity. In a bid for common resources, the space program had a sparse chance of being a priority over the development of newer long-range ballistic missiles. Contrary to conventional wisdom, the space program was not a central component or instrument of Soviet state policy. At best, it was an added bonus—a perk that allowed the Party and the military to add to its resume in extolling the virtues of a socialist state. The unprecedented successes of Gagarin, Tereshkova, and others formed a useful but not indispensable tool in helping destroy the standard image of the Soviet Union as a nation of obsolete tractors and factories. And while Kennedy may have made Apollo an instrument of American state policy, given the track record of the U.S. space program up to the early 1960s, there was no reason to believe that the United States would actually put a human on the Moon before the end of the decade.

The earliest serious indication that highly placed Soviet space officials such as Korolev and Academician Keldysh were moving their thinking from a Mars expedition to a lunar landing

¹³⁸ The visit is described in Khrushchev *Nikita Khrushchev* tom 2 pp 476-78

¹³⁹ E mail correspondence Igor Afanasyev to the author November 23 1997 E mail correspondence Igor Afanasyev to the author November 28 1997

¹⁴⁰ In the document dating from July 1962 defending the NI project to the Keldysh Commission OKB-1 listed five major goals for the NI rocket presumably in order of their importance (1) defense objectives (2) scientific objectives (3) "research and mastery of human [flight] to the Moon and near planets of the solar system (Mars Venus) launches of automatic apparatus to the Sun and planets of the solar system with scientific goals" (4) "solution of separate applied objectives such as universal communications and radio broadcasting and television weather service solar service etc" and (5) problems involving ballistic flight This document is reproduced in full as "Report on the Powerful NI Carrier Rocket at the Meeting of the Expert Commission" (English title) in B V Raushenbakh ed *S P Korolev i ego delo suet i teni v istorii kosmonautiki izbrannyye trudy i dokumenty* (Moscow Nauka 1998) pp 363-82

came in late April 1963. At the time, Keldysh held a meeting of his Interdepartmental Scientific-Technical Council for Space Research to discuss a response to the Kennedy speech almost two years earlier. Besides Korolev, in attendance was his "high guard": Deputies Mishin, Bushuyev, Chertok, Kryukov, and Okhapkin. In a report, Korolev summarized the progress on the NI program and argued that its capabilities would allow a lunar landing mission as well as various military tasks in Earth orbit. The council acknowledged "the advisability of reporting to the [Central Committee] on issuing a special decree on accelerating this work."¹⁴¹ Deputy Chief Designer Kryukov recalled later that this reassessment toward the Moon had taken place because of "reports of American work on Saturn and the start of flight work of this complex." By this time, NASA had conducted four (Block I) Saturn I launches as part of the "first step to perfecting the Saturn V vehicle for lunar missions." "Although fired with only a live first stage, the launches, all successful, were hard evidence of NASA's commitment to the lunar landing goal.

If before there had been some doubts about the seriousness of the U.S. commitment, there was ample evidence of it in 1962 and 1963. By the summer of 1962, NASA engineers had finalized the basic external configuration of the Apollo spacecraft complex, and on July 11, 1962, NASA officials announced that they had selected the lunar-orbit rendezvous (LOR) profile to accomplish the lunar landing mission.¹⁴² The LOR profile used the launch of two separate lunar spacecraft. One would serve as "a mother ship" and orbit the Moon, while a second would land on the surface of the Moon. Once surface exploration was over, the lunar lander would lift off, dock with the "mother ship," and be discarded. Following lunar operations, the crew would boost the orbiter on a trajectory back to Earth. All elements of the Apollo complex would be launched on a single Saturn V. Work on the actual Apollo spacecraft was also progressing at an impressive pace. On August 14, 1963, NASA signed a definitive contract with the Space and Information Systems Division of North American Aviation to design and manufacture the Apollo Command and Service Module that would carry three astronauts to the Moon. A contract for the lunar lander, called the Lunar Excursion Module, was signed with Grumman Aircraft Engineering Corporation on March 11, 1963.¹⁴⁴

Acutely aware of falling behind the Americans, Korolev took his case to the top. During a meeting in early June 1963, days before the launches of Bykovskiy and Tereshkova, Khrushchev invited Korolev and Glushko to his private dacha ostensibly to try and "make peace" between the two warring designers. Later in his memoirs, Khrushchev recalls the conflict and his mediation efforts:

... differences of opinion started to pull them apart and the two of them couldn't stand to work together. I even invited them to my dacha with their wives. I wanted them to make peace with each other, so that they could devote more of their knowledge to the good of the country, rather than dissipate their energy on fights over details. It seemed to me that they were both talented, each in his own field. But nothing came of our meeting. Later Korolev broke all ties with Glushko. He switched to ... Kuznetsov, a young, talented engine designer.¹⁴⁵

141 Chertok *Rakety i lyudr* p. 230. This meeting was held on April 28, 1963.

142 Ezell *NASA Historical Data Book Volume II* p. 56. The first four Saturn I launches were accomplished on October 27, 1961; April 25, 1962; November 16, 1962; and March 28, 1963.

143 *Ibid.* p. 182. See also Roger D. Launius *Apollo: A Retrospective Analysis* (Monographs in Aerospace History No. 3) (Washington, DC: NASA History Office, July 1994), pp. 10-12, which is an excellent account of the battles over the decision to opt for the LOR profile for the Apollo program. NASA Administrator James E. Webb officially announced the LOR decision on November 7, 1962.

144 Ezell *NASA Historical Data Book Volume II* pp. 172-183.

145 Nikita Khrushchev *Khrushchev Remembers: The Glasnost Tapes* (Boston: Little, Brown & Co., 1990).

Khrushchev, Korolev, and Clushko spent the morning of their meeting discussing, among other things, the N1 and its role in a piloted lunar landing. Using a number of beautifully illustrated drawings of his N1 rocket and proposed lunar spacecraft, Korolev painstakingly explained the requirements and mission profile of a Soviet lunar landing project. At the time, OKB-1 plans seem to have involved an Earth-orbit rendezvous profile using three N1 rockets to launch portions of the lunar ship into Earth orbit. These components would link together and then fly toward the Moon carrying its cosmonaut crew. According to Khrushchev's son, Sergey, who was also present during this private discussion, the elder Khrushchev was:

enthralled by Korolev's idea. But he could also not forget Earthly concerns. He inquired how much this project would cost. This time Korolev had a separate list stating all the computations. By his estimation, approximately ten to twelve billion [rubles] would be necessary to accomplish the project over the same number of years. [Hearing the amount] Father wavered.¹⁴⁶

Korolev continued his presentation with a display of the N1, its emerging configuration, its launch complexes, and logistical problems, such as modes of transporting the booster to the launch site. Korolev expressed confidence that given the right amount of financial support, the N1 program could beat Apollo. At the end of his monologue, Khrushchev merely replied, "I'll think about it, you prepare your proposals. We will discuss and decide this in the Presidium of the Central Committee."¹⁴⁷

Cost was a particularly important factor in space policy planning at the time, particularly because of an agricultural crisis that peaked around 1963 that prompted the Soviet Union to rely increasingly on imported grain. Despite phenomenal industrial growth in the late 1950s, the poor record of the agricultural sector may have served as a catalyst for more conservative levels of funding in areas not essential for national defense.¹⁴⁸ The enormous amounts of money pouring into the development of nuclear weapons and ballistic missiles were clearly taking their toll, and attempts to downsize conventional weapons systems to compensate did not alleviate the crisis.¹⁴⁹ Food shortages and rising prices across the Soviet Union may have given pause to Khrushchev's consideration for a highly expensive space extravaganza whose political utility was dubious at best.

Khrushchev's wavering on the lunar landing issue did little to deter Korolev's single-mindedness. A little over a month after the high-level meeting, on July 27, 1963, Korolev sent a formal

¹⁴⁶ Khrushchev *Nikita Khrushchev* tom 2 p 446 The official conversion rate of the ruble to the dollar at the time was one to one

¹⁴⁷ *ibid* p 448 This meeting in early June is said to have occurred on June 13 1963 in another source See Rudenko "Space Bulletin 25 Years From the Landing" It seems however that Korolev was at Tyura Tam on June 13 for the Vostok 5/6 launches As for as the personal conflict between Korolev and Clushko the issue was the subject of a forty minute discussion among the three men behind closed doors No one knows what was said but all three emerged gloomy and obviously disturbed from the meeting Sergey Khrushchev claims to have heard Korolev mutter under his breath that Clushko was 'a snake in the grass' There were no further attempts by the Soviet leader to bring them together

¹⁴⁸ For mentions of the agricultural crisis see Daniloff *The Kremlin and the Cosmos* pp 143-44 Peter A Gorin "The Dark Side of the Moon Political Decisions Behind the Soviet Lunar Programs" presented at the American Association for the Advancement of Slavic Science Boston MA November 14-17 1996 Alexander A Danilov Michael M Corinov Sergei V Leonov Ekaterina P Lugovskaya Alexander S Senyavski and Alexander P Naumov *The History of Russia The Twentieth Century* (North Sydney Australia Heron Press 1996) pp 288-89

¹⁴⁹ The new military doctrine of relying on ICBMs was outlined in a major policy speech by Khrushchev on January 14 1960 at the 4th Session of the Supreme Soviet of the USSR He ended his speech with the following call "In modern times a nation's defense capability depends on firepower not on [the] number of men under arms Hence due to possession of nuclear weaponry the manpower of the Soviet armed forces would be reduced See Harriet Fast Scott and William F Scott *The Armed Forces of the USSR* (Boulder CO Westview Press 1979) p 42

proposal to key leaders in the defense industry that established clear, specific objectives the NI could accomplish. He listed three primary goals in order of their importance: exploration of the Moon, exploration of the planets, and the launch of an Earth orbital station. Whereas before lunar exploration was consigned as a secondary objective. Korolev was unequivocal in his strategy:

*The accomplishment of a [landing] expedition of humans to the surface of the Moon should be considered the primary goal in the program of study and familiarization of the Moon. All remaining goals enumerated here should be concurrently achieved to facilitate the solution of the primary goal—the accomplishment of a [landing] expedition.*¹⁵⁰

In the July 1963 document, Korolev proposed eight specific projects, the first of which was a piloted landing on the surface of the Moon. The preliminary conception involved launching three NI rockets to assemble a 200-ton complex in Earth orbit through rendezvous and docking. A five-ton lander would perform the landing itself. To ensure safety, a reserve lander would supplement the main lander. The second and third goals were the creation of robotic lunar rovers with masses of six to eight tons and piloted lunar spacecraft with masses of ten tons. The remaining five objectives pertained to missions to Mars and Venus: the piloted TMK-1 for circumplanetary flights, automated spacecraft to orbit the planets, robotic vehicles to land on them, a piloted landing on Mars, and the development of a family of spaceships for further planetary exploration.¹⁵¹

Ironically, just as Korolev was beginning to marshal all his skills to convince the Soviet leadership of the need to respond to Apollo, the *public* discourse on whether or not the Soviets were in a "race to the Moon" reached its apotheosis. Much of this near hysteria was set off by a letter from British astronomer Sir Bernard Lovell to NASA Deputy Administrator Hugh L. Dryden concerning future Soviet plans in space. Lovell had toured a number of important aerospace facilities in the USSR between June 25 and July 15, 1963, and met a number of prominent scientists from the Academy of Sciences. Based on his experiences, he informed Dryden in a letter dated July 23 that Academy President Mstislav V. Keldysh had informed him that the Soviet Union had rejected "(at least for the time being) . . . plans for the manned lunar landing."

Lovell's assertion set off a remarkable level of parrying back and forth between the U.S. media and NASA as the space agency sought to quell suggestions that it was in fact racing to the Moon by itself.¹⁵² The U.S. hoopla was not reported in the Soviet press, although it is less certain whether individuals such as Khrushchev, Keldysh, and Korolev were kept abreast of the

150. This document, addressed to S. A. Zverev (State Committee for Defense Technology), V. D. Kalmykov (State Committee for Radio-Electronics), and M. V. Keldysh (USSR Academy of Sciences), has been reproduced in full as S. P. Korolev, "Report on the Use of the NI (11A52) Carrier and the Creation of First-Order Space Objects on Its Basis" (English title), in Raushenbakh, ed., *S. P. Korolev i ego delo*, pp. 410–16. An identical letter was sent on July 30, 1963, to Chief Designers N. D. Kuznetsov (OKB-276), N. A. Pilyugin (NII AP), and M. S. Ryazanskiy (NII-885). See also Kryukov, "The Brilliance and Eclipse of the Lunar Program."

151. Korolev, "Report on the Use of the NI (11A52) Carrier." The circum-Martian TMK-1 would have a mass of seventeen tons. The piloted Mars landing, on the other hand, would be accomplished by creating a massive 330- to 660-ton complex in Earth orbit requiring between six and twelve NI launches. Among supplementary goals mentioned in the document are robotic exploration of Mercury (six tons), Jupiter (three tons), Saturn (one and a half tons), Uranus (one ton), and Neptune (eight-tenths of a ton). The orbital station, called an "Orbital Space Institute," would be constructed in two stages. Initially, the NI would launch a seventy-ton station in a 500-kilometer orbit followed by a larger 200- to 300-ton version assembled by using three to four NI launches. The station would be serviced by 7K Soyuz spacecraft.

152. Sir Bernard Lovell, letter to Hugh L. Dryden, July 23, 1963, file on Sir Bernard Lovell, NASA History Reference Collection, NASA History Office, NASA Headquarters, Washington, DC.

153. For a detailed discussion of the repercussions of the Lovell letter, see Dodd L. Harvey and Linda C. Ciccoritti, *US-Soviet Cooperation in Space* (Miami, FL: Center for Advanced International Studies, University of Miami, 1974), pp. 114–19.

discourse in the United States. The issue was further muddied by President Kennedy's bold announcement, in front of a United Nations audience on September 20, proposing the discussion of "a joint expedition to the moon."¹⁵⁴ Judging by the response in the Soviet press, the USSR was simply not interested: Kennedy's offer was publicly ignored. Khrushchev added to the confusion with another ambivalent statement on Soviet lunar plans made at the third World Meeting of Journalists in Moscow on October 25:

At the present time we do not plan flights of cosmonauts to the Moon. I have read a report that the Americans wish to land on the Moon by 1970. Well, let's wish them success. And we will see how they fly there, and how they will land there, or to be more correct "moon" there. And most important—how they will get up and come back. We will take their experience into account. We do not wish to compete in sending people to the Moon without thorough preparation. It is *obvious* there would be no benefit from competition.¹⁵⁵

Once again, Khrushchev's pronouncements were taken as an indication of the Soviets' lack of interest in the Moon.

It is difficult to speculate on the true nature of events actually occurring within the Soviet leadership at the time without access to still-classified documents. But if we are to believe the Soviet leader's son, Khrushchev was close to making an about-turn in his thinking on the lunar landing issue. Sergey N. Khrushchev, then an engineer at Chelomey's design bureau, recalls that in the second week of September, just days after Kennedy's United Nations speech, his father for the first time openly spoke about jointly cooperating with the United States on a lunar landing project. Previous overtures from Kennedy on this issue had been rejected outright as a result of the Soviet military's great reluctance to engage in any major joint space endeavor. It seems that Khrushchev, however, had been steeling for a fight to change the military's position on the issue, certainly a difficult undertaking given the kind of secrets that would be put at risk in implementing such a joint project. When his son argued that cooperation was simply a bad idea, the older Khrushchev replied: "You don't understand that the Americans can design anything they want and our secrets will not be secrets forever . . . and now that we have enough missiles they already know that we are strong."¹⁵⁶

There is no doubt that Khrushchev's intentions were partly motivated by economic considerations. Surprised by Korolev's estimated cost of a lunar landing at the meeting in June, Khrushchev was already backtracking on his lukewarm support from three months before. The fact that Khrushchev was indeed having a change of heart is evidenced by his only public comment on Kennedy's speech. On November 1, a little over a month after the call for cooperation, Khrushchev told the press:

We consider with due attention to the proposal of the U.S. President, that it would be useful *if* the USSR and the United States pooled their efforts in exploring outer space for scientific purposes, specifically for arranging a joint flight to the Moon. Would it not be fine *if* a Soviet man and an American woman flew to the Moon? Of course *if* would.;

154. *Ibid.*, p. 123

155. *Soviet Space Programs, 1962-65*, p. 360.

156. Khrushchev, *Nikita Khrushchev tom 2*, pp. 459-61; Khrushchev interview, October 10, 1996

157. Harvey and Ciccoritti, *U.S.-Soviet Cooperation in Space*, p. 125

The chance to address a cooperative venture never came. Before Khrushchev could respond. President Kennedy was assassinated on November 22, 1963. The new administration of Lyndon B. Johnson was significantly less interested in a joint lunar landing program. Khrushchev also dropped the matter, never officially responding to Kennedy's United Nations speech.

Three factors—the rising interest from the Soviet leadership, the challenge from Apollo, and the question of how exactly to use the NI—all intersected in late 1963, prompting the Soviet space program to reassess its trajectory. The last issue, the utility of the NI, found its way into the debate in a roundabout way. A year before, in December 1962, an Academy of Sciences proposal had excluded the use of the NI and ambitious piloted space expeditions from the immediate future of the Soviet space program. This suggestion apparently had the support of some highly placed defense industry officials.¹⁵⁸ Alarmed by this indifference to the NI, Korolev had fired off a letter on May 7, 1963, imploring the Academy of Sciences to revise its recommendation to include the NI in its plans; fortunately, the academy responded favorably to Korolev's call. On August 10, Korolev received a revamped proposal from the academy that explicitly included both the NI and human space exploration in its plans. Probably prompted by the increased visibility of the Apollo program, the academy suggested large-scale exploration of the Moon and planets. With the academy recommendation in hand, and also encouraged by Khrushchev's lukewarm interest, Korolev and his associates at OKB-1 produced a detailed technical document on September 23, 1963, titled "Proposals for the Research and Familiarization of the Moon." This document served as the first specific response to Kennedy's challenge to go to the Moon. Both robotic and piloted space missions to the Moon figured prominently in the report.¹⁵⁹

Korolev divided his lunar plan into five major programs or "themes," each encompassing a specific goal, leading to a lunar landing in 1967 or 1968:

Type	Mission	Spacecraft	Launcher	No. of Launches
L1	Circumlunar	7K crew vehicle 9K upper stage 11K tanker	Soyuz	6
L2	Lunar roving	9K upper stage 11K tanker 13K rover	Soyuz	6
L3	Lunar landing	7K crew vehicle (modified) Lander	Soyuz NI	1 (Soyuz) 3 (NI)
L4	Lunar orbit	7K crew vehicle (modified)	NI	1
L5	Advanced lunar roving	Lunar rover	NI	

¹⁵⁸ State Committee for Radio Electronics Chairman V. D. Kalmykov apparently proposed delaying the conceptualization of payloads for the NI until a later time. See Raushenbakh, ed., *S. P. Korolev i ego delo*, p. 424.

¹⁵⁹ This document has been reproduced in full as S. P. Korolev, "Proposal for the Research and Familiarization of the Moon" (English title) in *ibid.*, pp. 416–26.

Theme L1 was identical to the 7K-9K-11K Soyuz circumlunar complex that had been proposed by Korolev since about 1963. It involved launching a series of tankers into Earth orbit to fuel a translunar-injection stage, which would send a 7K Soyuz spacecraft around the Moon. Theme L2 was an initial concept for a robotic lunar rover to travel on the lunar surface for scientific research. This, too, would be assembled in Earth orbit with a combination of tankers and acceleration stages.

L3 was clearly the center of Korolev's plan. Although several different mission profiles were considered, engineers chose the conservative Earth-orbit rendezvous approach to accomplish the flight. The primary crew vehicle would be a modified Soyuz spacecraft. The main landing payload would be launched into Earth orbit by an NI, followed by two more NI rockets, which would carry extra propellant for the translunar injection stage. A fourth launch of an R-7-derived booster was to carry a crew to the complex. Total mass in Earth orbit would be 200 tons; twenty-one tons would actually accomplish the landing on the Moon. Theme L4 was to conduct piloted lunar orbital missions using a modified Soyuz spacecraft with a special booster stage. Theme L5's primary goal was advanced roving missions on the Moon: cosmonauts could use these large five-and-a-half-ton rovers to travel long distances across the surface."¹⁶⁰

On the same day that he signed his lunar plans, Korolev sent a letter to senior officials at his ministry proposing an eleven-point plan for space research during the period 1965 to 1975 and outlining the primary steps leading to a piloted lunar landing. Curiously, even as his financial troubles were rising, he refused to abandon old dreams. He continued to include as future goals piloted missions to Mars and Venus and giant Earth-orbital stations.

The September 1963 document laid the *conceptual* foundation for the Soviet reach for the Moon in the late 1960—a clear and unambiguous response to competition from Apollo. Korolev, however, had to address not only competition from the outside, but also competition from within. Starting with a primary focus on strategic ICBMs, Chief Designer Mikhail K. Yangel's OKB-586 had slowly moved into designing small military satellites for a variety of purposes. The design bureau also fielded a series of new launch vehicles for the most high-security military payloads. None of this would have any relevance to the piloted space program had it not been for Yangel's proposal for a heavy-lift launcher named the R-56, for which a development program had been approved in April 1962. From the beginning, it seems that Yangel had had his mind set on a particular goal for the R-56. As one of his deputies described:

This launch vehicle was predicted in a monoblock variant, and according to [the] evaluation of specialized institutes, it was the optimum rocket for realization of the programs given, including auxiliary tasks on Moon exploration. . . . "

A draft plan for the vehicle and possibly its lunar spacecraft complex was prepared by 1964, thus positing it as a direct threat to Korolev's beloved NI. Chelomey, not content to watch his two rivals whiz past him, was also thinking of conceptions of a lunar landing spacecraft. His efforts were far behind the curve as compared to either Korolev or Yangel, and his participation in such a project did not figure in any significant way, at least not at the time.

At the beginning of 1964, the complacency that had marked the Soviet response to Apollo no longer existed, and notwithstanding Yangel's R-56 idea, no one more than Korolev was

¹⁶⁰ *Ibid*

¹⁶¹ S. N. Konvukhov and V. A. Pashchenko. "History of Space Launch Vehicles Development," presented at the 46th International Astronautical Congress, Oslo, Norway, October 2-6, 1995. The R-56 was a three stage rocket with a launch mass of 1,400 tons, capable of putting roughly fifty tons into orbit. The sixty-eight-meter tall booster was derived from an earlier proposal for a giant booster named the RK-100, which was studied by Yangel in the early 1960s.

responsible for this change. Yangel may have been the best individual in the USSR to build missiles, but it was Korolev who had unbridled passion for space exploration. He clearly had more to lose if the "space race" was lost; he had bet his life on preeminence and was not about to lose it to a government that was unwilling to be sympathetic to his grand ideals. By early 1964, there were finally murmurs of political activity on the topic. On February 11, 1964, Air Force representatives visited the offices of the Military-Industrial Commission in the Kremlin. a visit prompted partially "by the appearance of a series of reports that the Americans already have trainers for work on a lunar landing."¹⁶² One of the Air Force generals present. Lt. General Kamanin, wrote in his journal the following day:

... the Central Committee is approving a plan for sending an expedition to the Moon in 1968-1970. The N1 rocket, which is capable of putting into orbit a payload of 72 tons will be used for this purpose. The mass of all the systems (lunar ships), computed for flight to the Moon, lunar landing, and recovery on Earth, will comprise about 200 tons, i.e. it will require three N1 rockets and two dockings in orbit. The plan is still only on paper, while the Americans already have done much for carrying out flights to the Moon.¹⁶³

To accelerate the process, Korolev, accompanied by his First Deputy Mishin and Chief Designers Kuznetsov and Pilyugin, met with Khrushchev on March 17, 1964. Although the meeting was ostensibly about the general progress of the Soviet space program, a Moon landing seems to have been foremost on the agenda. After discussing robotic exploration and the Soyuz and Voskhod programs. Korolev raised the topic of the future of the N1 rocket. In his preparatory notes for the meeting, he had outlined several topics of discussion: the use of the N1 for the Ministry of Defense, a piloted lunar landing, piloted interplanetary missions, the development of liquid hydrogen rocket engines and nuclear rocket engines, and a global communications satellite system.¹⁶⁴ What was precisely said at the meeting still remains a mystery, but recent evidence suggests that it was that day that Korolev extracted a promise from Khrushchev to *politically* commit to a full-scale lunar landing program to compete with Apollo.¹⁶⁵ It is still unclear as to why the Soviet leader agreed at this time, when just six months before, financial considerations had prompted him to seriously consider cooperating with the United States. His son's observations on Khrushchev's views on the lunar landing allow some insight into his thinking at the time:



This is one conception of Mikhail Yangel's R 56 booster at a museum in Moscow. Yangel proposed the R 56 as a competitor to Korolev's N1 Moon rocket in 1962-64. The modular construction was based on clustering several heavy R-46 ICBMs. The R 46 was designed to carry fifty megaton warheads.
(copyright Mark Wade)

¹⁶² N. Kamanin, "A Goal Worth Working for" *The Space Diaries of a General* (English title) *Vozdushniy transport* 43 (1993): 8.

¹⁶³ *Ibid.*

¹⁶⁴ Korolev's notes have been reproduced in full as S. P. Korolev, "Plan of Notes to N. S. Khrushchev" (English title) in Raushenbakh, ed., *S. P. Korolev i ego delo*, pp. 442-44.

¹⁶⁵ Interview with Georgiy S. Vetrov, *Historian*, RKK Energiya, November 15, 1996.

*His feeling [on the lunar landing] was uncertain. He wanted to be ahead of the Americans, but for free. So when Kennedy announced the lunar program he did not accept Korolev's pressure that we have to do the same. And in the end all of them [the chief designers] pressed him and said that it would be much less expensive than the Americans and that we have to do this and [it was] then that he accepted this. So he approved it but I don't think that he spent too much of his own time thinking about this and discussing it. It was not such a national priority as in the United States.*¹⁶⁶

From Korolev's perspective, there were clearly two differing motivations to the decision to go to the Moon: one was to compete with Apollo and the second was to salvage the N1 rocket from the scrap heap of history. Consigned to oblivion by the lack of funding, the project was at a standstill in early 1964. No one, least of all the Ministry of Defense, had defined a reason for its existence. He had just given it one. Both these motivations are crucial to an understanding of the eventual fate of the program. The former—that is, to compete with Apollo—was a major and unprecedented shift in vision from the Tsiolkovskiy-influenced ideas of Earth-orbital stations leading to interplanetary flights. The latter—that is, to save the N1—was simply a management strategy. Within five days of the meeting, Korolev signed off on a new plan of action at his design bureau for 1964 through 1966, focused on the N1, with special attention to advanced liquid hydrogen engines for the upper stages.

Khrushchev had made the promise, but it was still a verbal commitment. There was a bureaucratic gridlock to address. The February–March discussions were to have led to a formal decree of the Central Committee and the Council of Ministers. This, however, was constantly delayed. Party and state officials were unconcerned with the N1 because it had not been included in the original program of research for the next five-year plan. As a result, money for the N1 remained tied up. In three letters dated May 15, Korolev wrote to the leading administrators in the defense industry to include the N1 as part of future funding allocations.¹⁶⁷

The draft of a fourth desperate letter was prepared by Korolev on May 25 and addressed directly to Leonid I. Brezhnev, the Secretary of the Central Committee for Defense Industries and Space, the top space program leader in the country at the time. Declassified thirty years later, the draft stands testament to the complete disarray of the Soviet human space program by 1964. It began auspiciously with the phrase: "We have been wasting a lot of precious time on the N1." Through paragraph after paragraph, Korolev mentioned the litany of problems in the N1 program:

It will be sufficient to point out that the initial sum of 11 million rubles, which was decided on in 1964 by the Ministry of Defense for construction of the launch and technical position for the N1, was at [their] discretion unexpectedly reduced to 7 million rubles and now to 4 million rubles overall. The Ministry of Defense has refused to finance further the construction of the N1 despite the existing decrees. In May of the current year all the money will be used up for this [program], and construction of the launch [complex] of the N1 will completely stop in a few days. Up to now the plants have not been supplied with the necessary equipment and materials, and a lot of decisions and orders have not been carried out by the involved organizations. For more than two years, a whole number of assignments and orders agreed in decrees has remained

¹⁶⁶ Khrushchev interview, October 10, 1996.

¹⁶⁷ S. P. Korolev, "Report From S. P. Korolev to the Secretary of the TsK KPSS L. I. Brezhnev" (English title), *Nauka i zhizn* no. 5 (May 1994): 21–23, commentary to the document. The letters were addressed to Chief of the Defense Department of the Central Committee I. D. Serbin, Chairman of the Military Industrial Commission L. V. Smirnov, and Chairman of the State Committee for Defense Technology S. A. Zverev.

*unfulfilled and no one is questioned about it. With regard to many problems and plans prepared for the NI, many months go by and no one even examines them. . . .*¹⁶⁸

Korolev then made a politically motivated plea:

*This is an absolutely intolerable situation with the NI, not only for Soviet science and technology but also for maintaining the priority of our state in that most important and difficult sphere, space, as the first socialist country in the world, the birthplace of great revolutionary ideas and a progressive nation leading the world in the socialist system. Nikita Sergeyevich Khrushchev has always supported progressive science, and in particular, much new work in the sphere of new technology and space research, and he has said more than once that socialism—this is the hopeful starting point from where all our rockets and ships will be launched. Very recently Nikita Sergeyevich listened to and supported the proposal of a group of Designers to speed up work on the NI. Two months have passed since then and nothing has been accomplished and nothing has changed with the NI . . . it's evidently clear that once again the NI hasn't received enough attention while time is slipping away. . . .*¹⁶⁹

He then mentioned the U.S. space program:

*The scope and progress of the work on "big space" in the U.S.A. is a reason for great alarm. Already in May of this year, the U.S.A. is preparing to fly the two-stage "Saturn" rocket with a full-scale model of the "Apollo" ship designated as part of the project to land American researchers on the Moon. This model is without people on board now, but this flight undoubtedly will be followed by others. At the present the U.S.A.'s "Saturn" rocket takes a useful payload of 11-12 tons with a total mass of around 17 tons into an initial orbit around the Earth. In this, the U.S.A. has already surpassed the Soviet Union.*¹⁷⁰

Conscious of the fact there was a real competition in the piloted circumlunar effort between Chelomey's LK-1 and Korolev's Soyuz, Korolev reminded Brezhnev of the pathetic state of the Soyuz program:

To fly around the Moon with a crew (without landing) it is sufficient for the U.S.A. to double this load [of 12 tons], for example, by using a single-docking method in the initial orbit. We have been working on such a theme, the "Soyuz," for a number of years, but unfortunately, just like the NI, it has never received adequate support, and [the work on it] has not been fully satisfactory. If urgent additional measures are not adopted on the "Soyuz" theme, the Soviet Union will lag behind the U.S.A. in this area too."

Following more complaints about the poor state of the liquid hydrogen industry and the industry's favoritism in the use of toxic propellant components, Korolev finally ended with a focused and specific plea for a Soviet response to Apollo:

The U.S.A. is planning to land people on the Moon in 1969 (instead of the earlier date of 1970) and according to their plans, they will be in a position to fly around the Moon

168. *Ibid.*, p. 21.

169. *Ibid.*, pp. 21-22.

170. *Ibid.*, p. 22.

171. *Ibid.*

(in 1966); in 1967 the U.S.A. expects and evidently will have a working variant of the "Saturn-5" with a launch mass of 2,700-3,000 tons. at which time the U.S.A. will be able to fly into space many times without limitations. It's possible to visualize the following scenario: what is to prevent the U.S.A. from accelerating its work a little bit (which is of enormous scale and part of a well coordinated plan), to not only fly around the Moon, but also to land men on its surface in 1967, the year of the fiftieth anniversary of the first Soviet state on our planet? There are three years left to that momentous date. In this time, we can pay attention to and organize our work to solve the problem of landing Soviet researchers on the surface of the Moon and secure their return to Earth . . .¹⁷²

Only the draft of the letter has been declassified, but Korolev's language strongly hints at his priorities of the period. The piloted lunar program had clearly split into two disjointed efforts: a circumlunar track with proposals from Chelomey (LK-1) and Korolev (Soyuz) and a landing track with proposals from Yangel (R-56) and Korolev (N1). With Apollo rising, the chief designers all rushed to respond. There is no question that the leading space designers were indeed scared to the bone by Apollo. Although Western observers had nary a clue, the heydays of Sputnik and Gagarin were irrevocably over.

Just three days after signing the draft of the letter to Brezhnev, on May 28, 1964, the first dummy Apollo spacecraft was inserted into Earth orbit by the sixth Saturn I booster." For those "within the know" in the Soviet space program, the contrast between the obsolete Vostok and the flying Apollo was crystal clear. The impetus to approve Korolev's program, if on shaky ground before, had a more imposing imperative. Within two months, the Central Committee and the Council of Ministers issued two landmark decrees that finally responded to Apollo. The first one, on June 19, guaranteed additional funding for the N1 lunar rocket and reset the start of flight testing to 1966 from the originally mandated 1965.¹⁷⁴ Given the damage caused by the inactivity in 1963-64, some engineers privately believed that even 1966 was too optimistic. To support the future Soviet space projects, a total of sixteen N1 boosters were to be manufactured between 1966 and 1968.¹⁷⁵

¹⁷² *Ibid* p 23 Authors emphasis

¹⁷³ Roger E Bilstein *Stages to Saturn: A Technological History of the Apollo/Saturn Launch Vehicles* (Washington DC NASA SP 4206 1996) pp 328-29

¹⁷⁴ Note that one source suggests that this decree was issued on July 27 1964 not June 19 For the former see Raushenbakh ed *S P Korolev i ego delo* p 444 For the latter see pp 692-93 in the same source This decree also "invited" OKB 586 and OKB 456 to cooperate with OKB 1 on developing the N1

¹⁷⁵ Afanasyev "N1 Absolutely Secret Part II" Another reliable source states that twelve N1 boosters were to be built as per the original plan See Boris Arkadyevich Dorofeyev "History of the Development of the N1 L3 Moon Program" presented at the 10th International Symposium on the History of Astronautics and Aeronautics Moscow State University Moscow Russia June 20-27 1995 Four days after this decree was issued on June 23 1964 Korolev convened for the first time all the leading chief designers of the space program to discuss both the N1 and its use for a piloted lunar landing The central point of debate was whether to directly develop a high energy liquid hydrogen-equipped N1 or to begin with a conventional propellant variant and then move to the more advanced version Given the governments poor response in supporting liquid propellant engine development the chief designers overwhelmingly supported initial development of the conservative 'K' variant Korolev proposed that they would gradually develop the most preferred liquid hydrogen version the 'V3' for future missions Five different models of the N1 were considered K V1 V2 V3 and D A These differed as follows K—liquid oxygen (LOX) kerosene on all stages V1—LOX liquid hydrogen on first stage V2—LOX liquid hydrogen on second stage V3—LOX liquid hydrogen on third stage and D A—nitrogen tetroxide—unsymmetrical dimethyl hydrazine (UDMH) on all stages The D A was proposed by Chief Designer V P Glushko who evidently had not abandoned his quest to use storable propellants on the N1 despite the July 1962 decision by the Academy of Sciences recommending the use of cryogenic propellants on the booster Glushko believed that a "new" fuel hydrazine 50 would allow better characteristics than his earlier proposal in 1962 to use UDMH Korolev compromised with Glushko and agreed to let three teams assess the usefulness of Glushko's proposal These teams were led by V S Budnik (OKB 586) V P Mishin

The following month, on July 24, 1964, at a meeting hosted at the Military-Industrial Commission, its Chairman Smirnov fully sanctioned Korolev's proposal on the L3 lunar expedition as well as further work on liquid hydrogen rocket engines.¹⁷⁶ A week later, on August 3, the second decree (no. 655-268), titled "On Work on Research on the Moon and Outer Space," was signed into law.¹⁷⁷ It was a comprehensive "five-year plan" on space, which covered everything—scientific satellites, probes to Venus and Mars, spaceplanes, military satellites, and the Soviet piloted space program. Within the framework of the piloted space program, the Soviet Union committed to two separate piloted lunar projects to retain its status as the world's pre-eminent space power. The first was a human circumlunar project, and the second was a lunar landing project. The former was tasked to Chelomey's OKB-52; his new LK-1 single-pilot spacecraft would be launched on a modification of the UR-500 ICBM to accomplish a circumlunar flight before the beginning of the second quarter of 1967—that is, in time for the fiftieth anniversary of the Russian Revolution later in the year.¹⁷⁸ Funding was apportioned for the construction of twelve LK-1 vehicles. In addition to the circumlunar program, a program of four test launches to convert the UR-500 missile into a space launch vehicle was approved. Each of the boosters would carry a new heavy scientific satellite to be developed by Chelomey in cooperation with the Scientific-Research Institute of Nuclear Physics of Moscow State University.¹⁷⁹

The commitment to Chelomey's LK-1 circumlunar proposal was clear evidence of the astounding confusion inherent in the Soviet space program at the time. Less than two years before, the Soviet leadership had approved Korolev's 7K-9K-1 I K Soyuz complex for the exact same mission. Yet another victim of the rising and falling fortunes of chief designers, Korolev's program effectively received its death knell on August 3, 1964, despite at least two years of continuous work on elements of the Soyuz complex. What prompted this change of heart remains in the realm of speculation. Perhaps it was the complexity of the 7K-9K-1 I K plan, which required four to five dockings in Earth orbit. Perhaps Chelomey's plan offered advantages that Korolev's did not. Perhaps it was a case of Chelomey's charms winning over Korolev's charms. Or perhaps it was simply a decision made with no rational thought. What is clear is that Korolev fought hard for the Soyuz complex but lost. What is also clear is that true to character, he refused to give up on the circumlunar effort, raising the specter of many more battles between the two big designers.

(OKB-1), and V. P. Radovskiy (OKB-456). Given the allegiances of Mishin and Radovskiy, their recommendations were no doubt a foregone conclusion. The overall meeting was attended by S. P. Korolev (OKB-1), A. F. Bogomolov (OKB MEI), Ye. Ya. Boguslavskiy (NII-885), V. P. Barmin (GSKB SpetsMash), V. S. Budnik (OKB-586), V. P. Glushko (OKB-456), M. A. Golubev (OKB-154), A. Yu. Ishlinskiy (AN SSSR), M. V. Keldysh (AN SSSR), M. A. Kuzmin (OKB-165), N. D. Kuznetsov (OKB-276), V. I. Kuznetsov (NII-944), A. M. Lyulka (OKB-165), V. P. Mishin (OKB-1), N. A. Pilyugin (NII AP), M. S. Ryazanskiy (NII Priborostroyeniya), M. K. Yangel (OKB-586), and A. P. Yeliseyev (OKB-2). OKB-1 notes on the meeting have been reproduced as "Minute Notes at the Meeting of Chief Designers on the Course of Work on the N-1 Heavy Carrier" (English title), in Raushenbakh, ed., *S. P. Korolev i ego delo*, pp. 455–60.

¹⁷⁶ Raushenbakh, ed., *S. P. Korolev i ego delo*, p. 693. In attendance, besides Smirnov, were V. N. Chelomey, M. V. Keldysh, and S. P. Korolev.

¹⁷⁷ Semenov, ed., *Raketno-Kosmicheskaya Korporatsiya*, p. 252. V. Filin, "At the Request of the Reader: The NI-L3 Project" (English title), *Aviatsiya i kosmonavtika* no. 12 (December 1991): 44–45. Vetrov, "The Difficult Fate of the NI Rocket"; Afanasyev, "NI Absolutely Secret Part II"; N. Kamanin, "A Goal Worth Fighting for . . ." (English title), *Vozdushniy transport* 44 (1993): 8–9.

¹⁷⁸ Kamanin, "In the Future His Name Will Probably Be . . ."; Igor Afanasyev, "Without the Stamp 'Secret' Circling the Moon: Chelomey's Project" (English title), *Krasnaya zvezda*, October 28, 1995. Note that the latter source suggests that the title of the decree was "On Research on the Moon and Future Development Work on Research into Cosmic Space."

¹⁷⁹ Khrushchev, *Nikita Khrushchev*, tom 2, pp. 477–78; V. Petrakov and I. Afanasyev, "'Proton' Passion" (English title), *Aviatsiya i kosmonavtika* no. 4 (April 1993): 10–12. There were evidently other provisions of the decree related to Chelomey, including the development of more Raketoplans and winged and ballistic missiles.

The most important element of the August 1964 decree was clearly the commitment to a lunar landing competitive with the Apollo program. According to the guidelines of the document, which still remains classified, the lunar landing was to take place in 1967 or 1968, to roughly coincide with the fiftieth anniversary of the Great October Revolution. For the Soviets, the Kennedy deadline of 1969 was far less an important factor than the national celebration slated for 1967, a factor that was accurately picked up by both NASA and U.S. intelligence services in the mid-1960s. The actual landing was to be accomplished with the aid of the "L3" lunar complex launched on a single N1 booster. OKB-1 was given the contract to design and build the L3. While Korolev had lost out to Chelomey for the circumlunar program, he did win over Yangel's R-56 proposal. In the same decree approving further work on the N1, dated June 19, the Soviet government ordered the cessation of all work on the R-56 booster. In the world of political infighting among the designers, Yangel's engineers did not take the decision lightly. As one recalled, "[the R-56 was canceled] without any visible causes and reasons, this development work was suddenly stopped . . . [and] many specialists and scientists were sorry about this decision."¹⁸⁰ Perhaps there was some sense in the decision: Khrushchev, Brezhnev, and Smirnov may have been ready to squander piloted space program resources on both Chelomey and Korolev, but adding a third participant may have been simply too much. Khrushchev himself was reportedly reluctant to allow Yangel's heavy participation in space programs, believing that such a state of affairs might divert the otherwise focused designer from building better missiles for the Soviet state.¹⁸¹

It took the Soviet Union three years and three months to respond to Kennedy's speech to go to the Moon. Given what we now know about the relative poverty and ferocious infighting symptomatic of the Soviet piloted space program, this is not so odd. Westerners in the 1960s, with little information, naturally assumed that the piloted space program was a huge priority to the Soviet state—an indispensable vehicle for publicity relations that was at the center of Soviet science and technology policy. The blunt and sometimes caricatured propaganda that emanated from the Soviet press merely confirmed the worst fears of Western alarmists. In the Western writing on Soviet space history, it almost became customary to tout in every third paragraph how Khrushchev was continuously scheming to extract more propaganda benefits from his hapless pawn Korolev by ordering him to do this or that. The reality could not have been further from that. Khrushchev, it seems, was more concerned about money and missiles than he was about cosmonauts and the cosmos. Perhaps influenced by his son, or perhaps by his own instincts, he was never particularly interested in competing with Apollo.¹⁸² It was only Korolev's singular persistence—in letters, at meetings, and during conferences—that resulted in the August 1964 decision. It may have been the most important decision in the history of the early Soviet space program for it set the stage for ten long years of elusively searching for the Moon. In the end, the Moon proved to be as elusive for the Soviets during the era of Apollo as being first in space was for the Americans during the era of Sputnik.

¹⁸⁰ Konyukhov and Pashchenko "History of Space Launch Vehicles Development" One factor that played against the R 56 was that it would only be capable of accomplishing circumlunar flight or robotic lunar exploration. Because it was even less powerful than the N1 the R 56 would have had to fly multiple missions to perform a single piloted landing on the Moon.

¹⁸¹ See for example Khrushchev *Nikita Khrushchev* tom 2 p 169

¹⁸² One Soviet journalist remarked in 1990 that one of the reasons for Khrushchev's apparent reluctance to commit to a lunar landing program may have been because of advice from his son Sergey who was an engineer under Chelomey. See Leonard Nikishin "Inside The Moon Race" *Moscow News* April 11 1990 p 15

CHALLENGE TO APOLLO



CHAPTER TEN

“THERE ARE MORE THINGS IN HEAVEN AND EARTH...”

The Voskhod project effectively diverted attention from the natural progression of piloted space plans at OKB-1. The Soyuz program was temporarily in oblivion, having lost its primary *raison d'être*, while more adventurous plans such as interplanetary ships and huge space stations began to fall by the wayside in the competition with Apollo. As a result, the twelve months spanning the two Voskhod missions was a period best characterized as limbo for OKB-1: two spectacular missions emerged from the mysterious vacuum of the Soviet space program, disappearing forever, leaving no visible trace of exactly what gain had been extracted from the effort.

How to Design a Voskhod

A group of fifty engineers at OKB-1 under "lead designer" Yevgeniy A. Frolov were assigned the task of modifying the basic 3KA Vostok vehicle into the 3KV Voskhod vehicle within five months. The primary goal was to ensure a spaceflight by three crewmembers; all the other objectives were supplementary. There seems to have been a fair degree of opposition to the entire effort from Korolev's staff. Konstantin P. Feoktistov, the resourceful engineer who played a critical role in the design of the Vostok, was on the Voskhod design team. He later recalled how Korolev neutralized his internal opposition:

... we argued that it would be unsafe, that it would be better to be patient and wait for the Soyuz spaceship to be built. ... In the end, of course, [Korolev] got his way. In February 1964 he outwitted us. He said that if we could build a ship based on the Vostok design which could carry three people, then one of those places would be offered to an [OKB-1] engineer. Well, that was a very seductive offer and a few days later we produced some rough sketches. Our first ideas were accepted. We unveiled our plans for this new ship in March or April.'

Feoktistov was the first to propose omitting both the ejection seat and spacesuits from the Vostok, thus allowing three men to cram into the spherical capsule in regular clothing. There were "heated discussions" between physicians and engineers on the spacesuit issue, but the argument was settled by physical impossibility: it would have been simply impossible to fit

¹ "The Russian Right Stuff The Dark Side of the Moon." NOVA television show. #1808. WGBH-TV. Boston. February 27. 1991.

three men in a ship in pressure suits.' The deletion of the ejection seat had serious safety implications for both launch and landing. During launch, none of the three cosmonauts would be able to eject from the spacecraft in case of a launch failure; during landing, the cosmonauts would have to remain within the descent apparatus all the way to the dangerous impact on hard ground. Korolev addressed the first problem by tasking KB-2 of Plant No. 81 to speed up the development of a solid-rocket-propelled launch escape system that its Chief Designer Ivan I. Kartukov was creating for the Soyuz spacecraft. For the landing, OKB-1 engineers proposed the use of a "parachute-reactive" system first proposed for the modified Vostok missions in 1963. This was a three-level parachute system augmented by powerful solid-rocket motors to decrease velocity at the moment of landing. A final modification to the original Vostok design was the introduction of a secondary retrorocket engine. In the early Vostok missions, the cosmonauts could depend on natural atmospheric reentry if the retro engine failed. In the case of Voskhod, there would be no such luxury because the life support system would ensure optimal conditions for three people for only one day. If the retro engine failed after that day, the crew would die by the time of natural decay. The backup engine would ensure against such a possibility. Engineers benefited from the fact that almost all the major modifications to the original Vostok, such as the use of a reserve retro-rocket engine, had already been planned for the unflown "extended Vostok" missions in 1963. Thus the Voskhod design project was much less of a hurried process than typically described by Western historians.

Engineers completed the draft plan for the 3KV spacecraft in August 1964, and they began construction of two flight articles.' As plans stood at the time, the spacecraft would fly for one day in a 180- by 240-kilometer orbit with three cosmonauts. Unlike the earlier Vostok vehicles, the Voskhod spacecraft would be launched by an updated three-stage booster known as the 11A57, which was originally developed for launching Zenit-2 reconnaissance satellites.'

The primary changes to the Vostok spacecraft were:

- The removal of:
 - Spacesuits with their air-conditioning systems
 - The catapult, its survival kit, and parachute system
 - The movie camera
 - Biological experiment instrumentation

2 G. Salakhutdinov 'Once More About Space' (English title) *Ogonek* 34 (August 18-25 1990) 4-5
 Yu. A. Mozzhorin et al. eds. *Dorog v kosmos I* (Moscow MAI 1992) p. 63

3 The draft plan has been reproduced with disguised designations as S. P. Korolev "On the Possibility of Creating the Three Seat Voskhod Space Ship" (English title) in M. V. Keldysh ed. *Tvorcheskoye naslediyе Akademika Sergeya Pavlovicha Koroleva izbrannyye trudy i dokumenty* (Moscow Nauka 1980) pp. 470-76

4 This rocket, also called 'Voskhod', was yet another one in the long line of modifications of the basic R-7 ICBM that Korolev was producing to launch a variety of robotic payloads. The smaller Vostok spacecraft had been launched by the 8K72K booster, which was essentially the R-7 with a new upper stage with a thrust of just under thirty and a half tons. That rocket could put about just under five tons into orbit, far less than the five and a half tons needed for Voskhod. Instead of creating a new powerful engine for the upper stage, Korolev's people took the engine from the second stage of the R-9A ICBM and installed it in place of the old upper stage engine on the Vostok launcher. The new engine, the RD-0108 developed by Chief Designer Kosberg's OKB-154, had a vacuum thrust of 30.4 tons. The second stage engine of the R-9A had the designation RD-0106 and had a thrust of about thirty tons. This engine was used as the basis for several different engines, each with a similar level of thrust for a variety of three-stage R-7 launch vehicles. See Timothy Varfolomeyev "Soviet Rocketry that Conquered Space Part 4: The Development of a Four Stage Launcher 1958-1960" *Spaceflight* 40 (January 1998) 28-30; Timothy Varfolomeyev "Soviet Rocketry that Conquered Space Part 6: The Improved Four Stage Launch Vehicle 1964-1972" *Spaceflight* 40 (May 1998) 181-84.

- The installation of:
 - Three shock-absorbing *Elbrus* couches
 - New survival kits
 - A reserve solid-propellant braking engine
 - A spacecraft orientation system using ion sensors
- The replacement of:
 - A TV system of ten frames per second in favor of a system of twenty-five frames per second
 - The old radio-channel system with a new one
 - The old landing beacon in the descent apparatus with a new one⁵

By the time that the draft plan was completed, it was clear that Plant No. 81 would not have a working version of a tower-equipped launch escape system ready for the Voskhod launch. Korolev and his engineers took the risky step of moving on with a launch despite this glaring disregard for safety. In its 3KV draft plan, OKB-1 merely stated that it would be "difficult" to rescue the cosmonauts up to the first twenty-five to forty-four seconds of a launch: a more accurate term might have been "impossible." After the forty-fourth second, if there was an explosion, an identical mission profile to Vostok would be used whereby the payload would simply separate from the launcher, travel along a ballistic trajectory, and land by parachute. Before T+501 seconds, this landing would be in Soviet territory; after T+501 seconds and up to orbital insertion at T+523 seconds, the landing would be elsewhere.

In orbit, the three cosmonauts would have little to do except monitor the ship's systems and take pictures. The new TV system, developed in a cooperative venture by the Experimental Design Bureau of the Moscow Power Institute and NII-380, would consist of a camera within the cabin to observe the crew and one on the outside of the vehicle that could be controlled by the crew. One of the goals was apparently to take video of the third stage of the IIA57 booster after orbital injection as well as of Earth's surface and the Moon. The cosmonauts would at most have one full day of safety in orbit: the engineers had predicted an outflow of air from the Voskhod at 180 liters per minute as opposed to the fifty liters per minute on Vostok—a significant regression in capabilities. The new automatic ion orientation was to supplement a manual system for positing the vehicle correctly prior to retrofire. The primary motivation for installing the new system was to allow the ship to orient itself during passage through the "dark" side of their orbit, when the Sun was not in view. This had been a problem during the Vostok missions in which the vehicles were equipped only with a solar sensor. Ion-sensitive sensors would use the thin ionization layer around Earth to provide information on the longitudinal axis of the ship relative to the primary velocity vector.

The spacecraft had the standard TDU-1 liquid-propellant engine for the reentry burn. The supplementary retro engine was fueled by eighty-seven kilograms of solid propellants; total mass of the engine itself was 143 kilograms. The engine would provide a single powerful burst of 12,000 kilograms thrust, lasting approximately two seconds, which was sufficient to deorbit the descent apparatus. Following reentry, a triple-level parachute system consisting of an exhaust, a braking, and two primary parachutes would bring the *sharik* down to the ground. A probe, formally called the "distance contact instrument," would be deployed from the base of the descent apparatus to a length of 1.2 meters to make contact with the ground in advance of the spacecraft itself. At contact point, just prior to landing, one solid-propellant engine affixed to the base of the parachute would fire, dropping final velocity from about eight to ten meters per second to a bearable two-tenths meter per second. The Elbrus couches were designed to

5. Korolev. "On the Possibility of Creating."

mitigate the effects of touchdown by reducing loads from twenty to thirty g's for only five-hundredths second by the use of a special spring suspension system, which would allow movement of 200 to 300 millimeters back and forth."

Because of the placement of three new couches, the internal look of the spacecraft differed considerably from Vostok. The three seats were placed side by side in a triangular shape, with the middle one raised forward. The main instrument panel and the *Vzor* optical sight were located to the left side of the three couches instead of in front as in the Vostok vehicle. The dimensions of the 3KV Voskhod spacecraft were similar to the old Vostok: a length of five meters and maximum diameter of 2.43 meters. The spherical descent apparatus had a mass of 2,900 kilograms, about 500 kilograms heavier than Vostok. The complete two-module combination weighed 5,320 kilograms.

The landing profile of the Voskhod spacecraft with the parachute-reactive system and its landing probe was the focus of much testing throughout 1964, interrupted not only by failures but also by Korolev's own schedule. Astonishingly, OKB-1 did not have a single 3KV article to simulate landings, an indication of the poverty of the piloted space program. Meanwhile, there were literally dozens of similar vehicles coming off the factory line in support of the Zenit-2 and Zenit-4 reconnaissance satellite programs. In a desperate move, Korolev asked one of his old pre-GIRD associates, Petr V. Flerov, to take cosmonaut Titov's Vostok 2 descent apparatus from the OKB-1 museum, equip it with the necessary instrumentation, and test-drop it.

In the middle of the Voskhod development program, Korolev was allowed an unusual privilege: permission to leave the Soviet Union on a holiday. Through the year, he had been beset by worse-than-usual afflictions. On February 11, 1964, in the middle of a meeting at his office in Kaliningrad, he suffered a heart attack and spent several days in the hospital.⁶ Doctors had prescribed a long holiday, which was delayed several times by more pressing work. Korolev had always wanted to go abroad and had a particular fascination for going to England, but Secretary of the Central Committee Brezhnev opposed any visit to the West. In the end, he and his wife were allowed to fly to Czechoslovakia on June 27, the only time between 1947 until his death that Korolev left the Soviet Union. Secrecy was tight, and he was not even permitted to register in the guest book of the Czech Communist Party's Central Committee, a standard honor for important dignitaries. At the end of his visit of three weeks, he told his hosts, "When I come to Czechoslovakia the next time, you will know who I am."⁷

Korolev was unusually ambivalent about his anonymity. Noted Russian journalist Yaroslav Golovanov, in his 800-page magnum opus *Korolev: fakty i mify* (*Korolev: Facts and Myths*), writes that the designer rarely, if ever, talked about the issue with anyone. If the conversation moved in that direction, he would only say that anonymity allowed him to live a calmer life. Golovanov argues convincingly that Korolev may have even liked it in some perverse way. He liked the aura that surrounded his existence. When he read press accounts that speculated that Academicians Sedov, Blagonravov, or others were possibly the anonymous "Chief Designer," he never felt angry or irritated, evincing only a kind of weariness and "secret joy" at the ignorance of the authors. Secrecy itself was a way of living for Korolev, and it seems that he did not outgrow it through his life. He never kept any diaries, never brought any secret documents

6 *Ibid* A. V. Ponomarev, "2 June—75 Years From the Birth of Academician A. F. Bogomolov (1913)" (English title) *Iz istorii aviatsii i kosmonavtiki* 59 (1989) 47-50. K. P. Feoktistov, "The Development of Soviet Piloted Space Ships (Up to the Early 1970s)" (English title) in B. V. Raushenbakh ed., *Issledovaniya po istorii i teorii razvitiya aviatsionnoy i raketno kosmicheskoy nauki i tekhniki* (Moscow: Nauka, 1981) p. 113.

7 Yaroslav Golovanov, *Korolev: fakty i mify* (Moscow: Nauka, 1994) p. 771.

8 Ye. Chernykh, "Was Gagarin Really in Space? Cosmonaut No. 1 Flew Around the Planet One Time But This Fairly Shabby Canard Is Making the Umpteenth Orbit" (English title) *Komsomolskaya pravda* September 22, 1990, p. 3.

home, and never jotted down unauthorized comments in private notebooks. He may have told his wife Nina Ivanovna about some of the people involved with the space program, but he never talked about the program itself. When, after Gagarin's flight, she pressed him for details, he made her repeatedly swear an oath of "eternal silence," explaining to her a dozen times the need for secrecy. Finally, all he would tell her was that the rocket Gagarin flew into orbit had three stages. Once when she innocently uttered the word "Tyura-Tam" in the kitchen, Korolev instantly pricked up his ears, interrogating her for a long time on where she had heard such a word.⁹ About the secrecy in the Soviet space program, Golovanov writes insightfully that:

... this is exactly the path that we chose for the space program ... during Korolev's time, everybody and Korolev included, naively believed that secrecy was necessary because we were ahead. Secrecy was necessary so that no one would overtake us. But later when they did overtake us, we maintained secrecy so that no one knew that we had been overtaken."

Upon returning to Moscow on July 16, Korolev immediately dove back into the Voskhod preparations. Flerov had finished outfitting Titov's capsule for the drop-test, which was carried out on September 6 at the testing range at Feodosiya in Crimea. The test was a disaster: the parachute hatch failed to open, jamming the parachute in its container, and the descent apparatus, the second vehicle ever to carry a human into space, was shattered into smithereens.¹ It was clear that there were deficiencies in the new parachute system. Engineers from the Scientific-Research and Experimental Institute of the Parachute Landing Service, the subcontractors for both the Vostok and Voskhod parachutes, were closely involved in diagnosing the problems with the systems over the following weeks. Originally, Korolev had promised Khrushchev that the first Voskhod mission would be carried out in August 1964. This deadline, for obvious reasons, proved to be too ambitious. Following the accident with the landing, the launch was moved back a complete month to troubleshoot the problem. As per original plans, OKB-1 planned to launch an automated version of the 3KV vehicle into orbit for a one-day shakedown flight, albeit without dogs as originally slated.

Pilots, Engineers, and Doctors?

The question of who would fly on the Voskhod mission was an issue that was completely grounded in bureaucratic politics and clouded by personal interests unrelated to the mission goals. For several years, Korolev had publicly spoken about sending "passengers" into space on his ships. "Passengers" for Korolev was at that time merely an euphemism for young engineers from his own design bureau. He was of the opinion that the ones who actually built the ships should also have a chance to fly in them. This opinion was stated in a letter to the Soviet government in February 1962, but it was only with the Voskhod mission that there was state action

⁹ Golovanov *Korolev* pp 686-89

¹⁰ *Ibid* p 688

¹¹ There are contradictory dates referring to this accident. One source suggests that it was in late August. See *ibid* p 736. Kamanin implies in his diaries that the accident took place in early September. See N. P. Kamanin *Skrytyy kosmos knrga vtoraya 1964-1966gg* (Moscow: Infotekst IF 1997) p 80. A third source suggests February 6, 1964, which is probably an error for September 6, 1964. See B. Ye. Chertok *Rakety i lyudi goryachyie dni kholodnoy voyny* (Moscow: Mashinostroyeniye 1997) p 243. Note that there were several earlier tests of the Voskhod parachute system, but these probably did not use full scale descent apparatus modules. For example, Kamanin in his diary entry for September 2, 1964, wrote that there was a failure on August 29 because of a "spurious" jettisoning of the parachute hatch. According to Kamanin, by August 14, 1964, there had been ten landing tests of the parachute system, all probably without descent apparatuses.

on the matter." While one seat could be reserved for the usual Air Force pilot, the remaining two could be nonaviators. Korolev was well aware that the Air Force would find this completely unacceptable; the military had already firmly refused Korolev's earlier efforts to train OKB-I engineers for spaceflight.

For Voskhod, Korolev wanted to fly an OKB-I engineer and a doctor in the extra seats. For the engineer spot, he enlisted the support of President of the Academy of Sciences Mstislav V. Keldysh, although it is clear that Keldysh was more inclined to propose a scientist rather than an engineer, a difference in interpretation that later threatened to divide Keldysh and Korolev. Deputy Minister of Health Avetik I. Burnazyan, a veteran of the medical service for the nuclear weapons program, also threw in his support to Korolev for a doctor on the flight." The pilot-engineer-doctor combination was specified in the March 13 decree of the Military-Industrial Commission, which had first approved the Voskhod mission. It seems that the Air Force had conceded its position, retreating under the combined lobbying of Korolev, Keldysh, and Burnazyan.¹⁴ The fact that it was acceptable for these "passengers" to undergo training for a space mission for a period of only three or four months suggests something about the manner in which the leading officials viewed cosmonauts for the Voskhod and Vostok spacecraft—that they were more inert observers than active participants. With the exception of the politicians who flew on the U.S. Space Shuttle in the mid-1980s, it was quite possibly the most compressed training schedule ever for people preparing for spaceflight.

The Mandate Commission, responsible for approving individuals for cosmonaut training, examined applications from a number of physicians from various military and civilian institutions during April and May, naming the following four finalists on May 26:

- Lt. Colonel Vasilii G. Lazarev (thirty-six years old)
- Major Boris I. Polyakov
- Aleksey V. Sorokin (thirty-two)
- Boris B. Yegorov (twenty-SIX)

Yegorov and Lazarev were strong contenders, and both had influential supporters. By some twist of fate, Korolev had recently met with Yegorov's father, Boris G. Yegorov, who was an influential medicine specialist and a full member of the USSR Academy of Medical Sciences. The older Yegorov had confidentially told the chief designer of his young son's desire to fly in space. The latter clearly had the qualifications. Although a civilian, he had worked for a while at the Air Force's Institute of Aviation and Space Medicine and, in February 1962, was selected as one of the leading doctors who were part of parachute teams for recovering the Vostok cosmonauts. For some reason, Korolev was enamored with Yegorov, and with Deputy Minister Burnazyan's support, he was well placed as a primary contender for the mission. Yegorov's direct competitor was Lazarev, an accomplished Air Force officer and physician, also from the

¹² Yu. P. Semenov ed. *Raketno-Kosmicheskaya Korporatsiya "Energiya" imeni S. P. Koroleva* (Korolev RKK Energiya named after S. P. Korolev 1996) p. 425.

¹³ Golovanov, *Korolev* p. 731.

¹⁴ At a meeting of Air Force officials on March 24, 1964, Air Force officers including Kamanin and Cagarin agreed that two OKB-I engineers could fly in the "passenger" positions in the Voskhod. If such engineers were not ready for the flight, then they could be replaced by two Air Force pilots. The Ministry of Health proposal for a doctor seems to have been formalized by edict on April 2, 1964. See Viktor Mitroshenkov, *Zemlya pod nebom* (Moscow: Sovetskaya Rossiya, 1987) pp. 337–38.

¹⁵ V. Semenov, I. Marinin, and S. Shamsutdinov, *Iz istorii kosmonavtiki: uypusk I: nabory v otryady kosmonavtov i astronautov* (Moscow: AO Videokosmos, 1995) pp. 21–24. The date of birth and age of Polyakov is unknown. There were four other doctor finalists: I. S. Ivanov, G. P. Prostakishin, Yu. A. Senkevich, and G. L. Yaroshenko. See Kamanin, *Skrytiy kosmos, 1964–1966* p. 52.

Institute of Aviation and Space Medicine, with extensive research experience, exemplary flying skills, and the support of every Air Force general involved in the space program.¹⁶

To compete for the third seat, Korolev had sent fourteen of his engineers to participate in medical screening; only one was accepted for training on June 11, the ubiquitous Feoktistov, certainly one of Korolev's most accomplished proteges." Even at this early point, it was clear that more than anyone else, it was the thirty-eight-year-old Feoktistov whom Korolev favored for the coveted "engineer-or-scientist" seat on Voskhod. But the aloof Feoktistov had stiff competition from a real scientist, one whose presence on a space mission would be a significant advance in bringing pure science into the Soviet piloted space program. Georgiy P. Katys, also thirty-eight, and a Ph.D. from the Institute for Telematics and Automation, was known informally as "Keldysh's man." He was then a researcher at the Institute of Automation and Heat Technology of the Academy of Sciences, having been involved in a variety of space-related projects through the 1950s and early 1960s. Keldysh was not his only supporter; several other academicians, all heavily involved in the space program, declared their support for the congenial Katys, who was chosen from a list of eighteen academy scientists on May 26, 1964.¹⁸ There was an additional candidate, perhaps for the commander's seat, forty-year-old Vladimir N. Benderov, a test pilot from Tupolev's OKB-156, who was apparently proposed by the State Committee for Aviation Technology."

Benderov, Feoktistov, Katys, Lazarev, Polyakov, Sorokin, and Yegorov arrived at the Cosmonaut Training Center in early June. Two of them, Benderov and Polyakov, dropped out of the program within a month because of medical problems, leaving five—Feoktistov, Katys, Lazarev, Sorokin, and Yegorov—to compete for the two "passenger" seats.²⁰ For the commander's seat, the Air Force selected 1960 batch pilots Komarov and Volynov.¹ Both had served extensively in a backup capacity during the Vostok program, although Komarov had been briefly grounded for a cardiac problem similar to the one that had plagued NASA astronaut Donald K. "Deke" Slayton. Even with the Air Force cosmonauts, Korolev put his personal imprint on the selection. During an early training session in the TDK-3V Voskhod simulator at the Cosmonaut Training Center, Korolev had quietly observed Komarov's performance during training, and he made an on-the-spot decision, telling one of his deputies, "Here is the comrade who will command the 'Voskhod'."²² Although there were at least a dozen other powerful

16 Golovanov Korolev pp 733-34 Another source says that Yegorov joined the parachute teams in January 1961 See 'People and Fates In Memory of Boris Yegorov' (English title) *Novosti kosmonautiki* 19 (September 10-23 1994) 57-58

17 Of the fourteen OKB 1 engineers six were eliminated at a very preliminary stage These included O I Kozyuba and Ye A Frolov the latter being the 'lead designer' for the Voskhod spacecraft The remaining eight men were K P Feoktistov G M Grechko V N Kubasov O G Makarov V N Volkov A M Sidorov V A Yazdovskiy and V P Zaytsev See Kamanin *Skrytiy kosmos 1964-1966* pp 51 54

18 The academicians in favor of Katys were A Yu Ishlinskiy G I Petrov and V A Trapeznikov Apart from Katys there was one other finalist from the Academy of Sciences O B Moskaev See *ibid* p 52

19 Benderov's candidacy as a cosmonaut had actually been put forward as early as February 9 1964 before the initiation of the Voskhod program See *ibid* p 19

20 Six of the seven men arrived at the Cosmonaut Training Center (TsPK) on June 1 1964 the exception was Feoktistov who arrived on June 12 Although Benderov was out of the running for the Voskhod mission his candidacy for a cosmonaut seat was an issue of discussion as late as February 6 1965 See *ibid* pp 61 138

21 Initially by April 1 1964 the Air Force candidates for the commander position were V F Bykovskiy P R Popovich and G S Titov By April 22 the list had been expanded to include P I Belyayev Bykovskiy L S Demin Ye V Khrunov V M Komarov A A Leonov Popovich Titov and B V Volynov By May 21 the list was narrowed down to four Khrunov Komarov Leonov and Volynov Of these only Komarov and Volynov would train for Voskhod The remaining two Khrunov and Leonov were to train for the forthcoming Vokhod EVA mission See *ibid* pp 33-34 43 51

22 Golovanov Korolev p 732

individuals whom he had to go over, by late August, Korolev was publicly stating that one and only one crew would fly the Voskhod ship: Komarov-Feoktistov-Yegorov. Anything else would be unacceptable. As it turned out, a final decision on the crew was not made until just weeks before the launch.

On August 21, 1964, the Military-Industrial Commission met to discuss preparations for the Voskhod flight. Korolev, along with the leading chief designers and military officers, reported on the status of the program. Also present were the seven cosmonauts training for the flight, each of whom briefly reported that he was ready for the mission less than two months after selection. The commission agreed to launch an automated precursor with mannequins prior to September 5 and the actual piloted mission within the period of September 15–20. Lt. General Kamanin, one of the attendees, later wrote in his journal:

The Voskhod . . . has a number of shortcomings. Most important among them is the absence of crew rescue equipment . . . in the first 27 seconds of flight, and in the case of failure of the craft's parachute system during descent from orbit. Moreover, there is absolutely no way the Voskhod can land safely through natural deceleration—the reserves of air, water and food are small, and there is a high probability of over-heating. The crew is very cramped in the Voskhod: There is five times less space and air in the craft "per capita" than in the Vostok. In general, the life-support and safety conditions are considerably worse in the new craft than in the Vostok."

These feelings were no doubt exacerbated by the drop-test crash at Feodosiya in early September. The failure delayed the launch dates of both flights—the automated one to September 15 and the crewed one to late September or early October.

During this period, each side began to take its place in the battle to send its own representative into space in Voskhod. Kamanin insisted on Komarov, Volynov, and Lazarev—that is, an all-military crew with an Air Force doctor. This position was supported by higher Air Force officials until the hand of the Central Committee interfered. Volynov's mother was Jewish, and his candidacy was unacceptable to Chief of the Defense Industries Department Ivan D. Serbin, one of the most feared Party apparatchiks of the defense sector in the Soviet Union.²³ More commonly known by the moniker "Ivan the Terrible," Serbin had an impassive face but the "doctrinal" clout that could make or break people's careers. Officially, "all personnel issues and issues related to the dismissal, promotion, awarding or punishment of administrators needed Serbin's approval," but his *de facto* influence over the space program was obviously much wider, often encroaching into matters of policy.²⁴

There was another casualty to political doctrine. The Mandate Commission was aware that scientist Katys's father had been arrested and shot in 1937 during the Great Purges. Although he had been fully exonerated of his "guilt" in 1957, his son was considered suspect because of

²³ L. N. Kamanin "I Would Never Have Believed Anyone" (English title) *Sovetskaya Rossiya* October 11, 1989 p. 4

²⁴ Kamanin proposed the first tentative crews on July 6, 1964. They were Volynov, Katys, and Yegorov (primary) and Komarov, Feoktistov, and Sokorin (backup). These pairings were offered at an official meeting of the State Commission on August 12, 1964. By September 14, 1964, Kamanin was proposing Komarov, Volynov, and Lazarev (primary). See Kamanin *Skrytiy kosmos 1964–1966* pp. 63, 69, 84. Golovanov *Korolev* p. 737.

²⁵ Boris Chertok "At the Dawn of Russian Cosmonautics" *Aerospace Journal* no. 4 (July–August 1996) 77–78. See also John McDonnell "The Soviet Defense Industry as a Pressure Group" in Michael McGwire, Ken Booth, and John McDonnell, eds. *Soviet Naval Policy: Objectives and Constraints* (Halifax, NS: Centre for Foreign Policy Studies, 1975) pp. 102–03. The Defense Industries Department was one of twenty-two sections in the Central Committee.

his father's fate. The KGB also discovered in August 1964 that Katys's stepbrother and step-sister had resided in Paris, although they had emigrated in 1910—a connection that cast suspicion on Katys's adherence to working-class ideology. Kamanin noted in his diary. "All this spoils the candidate for flight. More suitable candidates should be found."²⁶ In both cases, Korolev was put in a difficult position. Although he preferred Komarov over Volynov as commander, he was also resolutely not anti-Semitic but was helpless to make amends for the poor Volynov. Katys's predicament hit home deeper: Korolev himself had been incarcerated during the Purges, serving at Kolyma, and here was the Communist Party throwing insult in his face by refusing to "clear" the son of another Purge victim.

Feoktistov, Korolev's chosen man for the engineer spot, faced stiff opposition from the Air Force. Despite his undeniable talents as a designer—Feoktistov probably knew more about the design of the Vostok and Voskhod spacecraft than any other engineer at OKB-1—he was also "a difficult, unsociable, and uncompromising man." His health was also not up to par. When Kamanin first heard of Feoktistov's candidacy, he was reported to have blurted out. "How can you put a man into a space ship if he is suffering from ulcers, nearsightedness, deformation of the spine, gastritis, and even has missing fingers on his left hand?" Doctors had in fact brought in all sorts of documents stating that Feoktistov was unfit for the mission. In the end, Deputy Minister of Health Burnazyan, under pressure from Korolev, signed a medical certificate in Feoktistov's favor, and Air Force officials backed down. The deletion of Volynov and Katys from the running and the support for Feoktistov meant that there were now two possible variants of the crew:

- Komarov-Feoktistov-Lazarev
- Komarov-Feoktistov-Yegorov

On September 14, Kamanin proposed the first version to Korolev. The chief designer, however, stuck to his earlier position and categorically refused to launch the crew without Yegorov aboard, perhaps as a result of a promise he made to the young doctor's father. Both Korolev and Kamanin came away from the meeting refusing to budge an inch, laying the ground for more battles in the ensuing days.

Korolev was clearly under great stress at the time, and it showed in his behavior toward other chief designers and junior engineers. Despite his poor health, he consistently tried to have his hand in the most trivial of operations, losing himself in fits of temper if he was displeased with something. There was also familial stress brought on by news that his wife would have to undergo a major operation on October 1. He twice flew to Moscow from Tyura-Tam to be with her during the most intensive prelaunch preparations.

On September 18, at a meeting of the State Commission for Vostok, OKB-1 Deputy Chief Designer Boris Ye. Chertok reported that the misfiring of the parachute cover during the earlier drop-test at Feodosiya was the fault of the design bureau itself. The main firing circuit would have to be redesigned and rebuilt from scratch. Engineers scheduled new drop-tests, although it was becoming clear that the automated precursor vehicle would have to be launched before the results of the new tests were in. After the main meeting, a smaller group of the leading State Commission officials met to discuss the makeup of the crew. Commission Chairman Tyulin fell in with Korolev and proposed the Komarov-Feoktistov-Yegorov crew, with only Air Force First Deputy Commander-in-Chief Marshal Sergey I. Rudenko and Kamanin in opposition. Korolev lost his temper, yelling. "The Air Force is perpetually jamming up the works! Looks like I'm

26 I Marinin "Russian Cosmonaut Scholars" (English title) *Novosti kosmonautki* 3 (January 28–February 11 1996) 49–54 Kamanin *Skrytiy kosmos* 1964–1966 pp 76–77

27 Golovanov *Korolev* p 737

gonna have to train my own cosmonauts. . . ."²⁸ The following day, perhaps under pressure from the Central Committee back in Moscow, Marshal Rudenko buckled under Korolev's whims, and Kamanin was the only one remaining who supported Lazarev. He finally gave in from exhaustion over the issue. Komarov, Feoktistov, and Yegorov would fly, just as Korolev had predicted two months before.

For weeks, the seven cosmonauts had been in the dark about which of them would fly in space. Their only source was rumor. Katys, for example, noted that before flying out to Tyura-Tam for the launch. Feoktistov and Yegorov were given Volga automobiles for travel around Moscow, while he was given "a clunker." Kamanin, with his authoritarian character, did not bother to include the cosmonauts in any discussion of the issue. As one Russian journalist wrote, "True to form, Kamanin did not inform the cosmonauts of the State Commission's decision for a very long time, consciously keeping them in a state of suspense, helping him, or so he thought, to maintain control over them."²⁹ Over two weeks after the final State Commission decision, the seven cosmonauts were still relying on rumor, unsure of who exactly would fly.

Operation Kedr

The intense prelaunch preparations for Voskhod were punctuated by an important state event. On the *morning* of September 24, Khrushchev, accompanied by an entourage of the highest defense officials in the Soviet Union, flew into Tyura-Tam to view demonstration launchings of new ICBMs and space rockets.³⁰ The exercise, code named Operation *Kedr* ("Cedar"), was the second military event in September, following a similar demonstration near Moscow of tank, artillery, and naval weaponry. The main goal of the grandiose visit was evidently to decide between competitive ICBMs that were on display: Chelomey's UR-200 versus Yangel's R-36, and Yangel's R-16 versus Korolev's R-9A. The three main designers, Korolev, Chelomey, and Yangel, greeted Khrushchev at the airfield at Tyura-Tam before taking the Soviet leader immediately to the launch pads. Launches were carried out over the next two days as Khrushchev, Brezhnev, Ustinov, and the others watched. Although the decisions were not strictly based on the performance of the missiles, when Chelomey's UR-200 failed during its launch, he found himself in an embarrassing position. On the second day, Yangel successfully launched his new R-36, followed by spectacular simultaneous launches of three R-16 missiles from underground silos."

28 Kamanin 'I Would Never Have Believed Anyone' The State Commission for the Voskhod launch was established by decree of the Central Committee and the USSR Council of Ministers on August 3, 1964. The commission consisted of Cha-rman G. A. Tyulin (CKOT), S. P. Korolev (OKB-1), M. V. Keldysh (AN SSSR), I. T. Bulychev (MO), L. I. Gusev (GKRE), N. P. Kamanin (WS), A. A. Karas (TsKIK), Kasatikov (affiliation unknown), K. A. Kerimov (TsUKOS), A. A. Kobzarev (GKAT), A. G. Mrykin (GURVO), G. S. Narimanov (NII-4), V. N. Pravetskiy (Ministry of Health), S. I. Rudenko (WS), Yakunin (affiliation unknown), and A. G. Zakharov (NIIP-5). See Kamanin *Skrytiy kosmos* 1964-1966 pp. 73-74.

29 Golovanov *Korolev* p. 738.

30 *Ibid.* p. 740. Aleksandr Zakharov "Operation Kedr or How the Proton Was Saved" (English title) *Krasnaya zvezda* July 15, 1995, p. 4. Among those escorting Khrushchev were L. I. Brezhnev (TsK Secretary for Defense and Space), I. D. Serbin (TsK Defense Industries Department), A. P. Kirilenko (TsK KPSS), D. F. Ustinov (Cha-rman VSNKh), L. V. Smirnov (Chairman VPK), C. N. Pashkov (Deputy Cha-rman VPK), R. Ya. Malinovskiy (Minister MO), A. A. Grechko (Deputy Minister MO), S. S. Biryuzov (General Staff Chief MO), S. G. Gorshkov (Commander VMF), N. I. Krylov (Commander RVSN), V. A. Sudets (Commander PVO), K. A. Vershinin (Commander WS), P. V. Dementyev (Chairman GKAT), V. D. Kalmykov (Cha-rman GKRE), S. A. Zverev (Chairman GKOT), and G. A. Tyulin (First Deputy Chairman GKOT).

31 Colovanov *Korolev* p. 740. The fact that these tests would occur was announced publicly by the Soviet press. See "Russians Schedule Pacific Rocket Test" *New York Times*, August 1, 1964, p. 8.

The Yangel-Chelomey battle over the new ICBMs had little to do directly with the piloted space program. The political maneuvering over the missile sector did, however, have a profound relevance to the Soviet space program. Khrushchev's son Sergey recalled later that the decision to pick Yangel's R-36 over Chelomey's UR-200 may have had less to do with technical considerations than with the whims of Ustinov:

The military men at the test range had already begun to show a preference for the Yangel missile. They were actively backed by Dmitry Ustinov. Although he was not directly involved in defense matters at the time, as one of the fathers of missilery in our country, he had extraordinary authority and his word meant a lot. As second secretary, Brezhnev was responsible for supervising the defense industry, but typically — with his softness of character — he had not expressed a definite opinion. . . . The energetic and single-minded Ustinov dominated the pliable Brezhnev."

This was definitely trouble for Chelomey and his plans to dominate the space program. Ustinov had consistently opposed any and every Chelomey plan; during the Khrushchev era. Ustinov had to be careful in opposing Chelomey because it was almost a matter of state policy to favor the general designer. Chelomey had continually ignored Ustinov by going directly to Khrushchev with his plans, although Ustinov served as the chair of the Military-Industrial Commission from 1957 to 1963. The battle between them was also personal. As Sergey N. Khrushchev recalled:

*. . . the personal behavior of both of them was not very polite. . . . Chelomey tried to blame Ustinov for many things. Of course, Chelomey never did this openly in Ustinov's presence. He tried to [exercise self-restraint] but could not stop himself. And of course these people reported back to Ustinov. . . . I heard many times when Chelomey in his own circles used certain words for Ustinov . . . and I'm sure that somebody reported back to Ustinov on this*³³

Chelomey did not take kindly to Ustinov's hostility. Once when Khrushchev ordered Ustinov to go see Chelomey about his UR-500 rocket. Chelomey intentionally kept Ustinov waiting in his reception room while other designers and junior engineers were escorted into the general designer's office. Rumor has it that Ustinov never forgave Chelomey for this humiliation.³⁴ Ustinov and Chelomey would remain at loggerheads throughout the rest of their lives, and more often than not, Chelomey remained a victim to Ustinov's single-minded crusade to destroy any and every single program the ambitious general designer proposed, including space projects.

The results of Operation *Kedr* seriously threatened Chelomey's dominance, and Khrushchev did nothing to stop it. For the first time since 1961, Chelomey was witness to a cancellation of one of his projects. The UR-200 was the critical center of all of Chelomey's early plans for space exploration — the launch vehicle that would open the door to independence and more grand boosters such as the UR-500. Its cancellation was a severe blow because it was supposed to have launched the first series of "IS" and "US" military satellites into orbit, while also serving as a new generation of ICBM. Despite the embarrassing failure during Operation *Kedr*, the missile itself had performed without much trouble throughout its testing program, which had begun in November 1963. All at OKB-52 were apparently demoralized by the

32 Sergei Khrushchev Khrushchev on Khrushchev An *Inside Account of the Man and His Era* (Boston Little Brown & Co. 1990) p 103

33 Telephone interview Sergey Nikitich Khrushchev with the author October 10, 1996

34 Golovanov *Korolev* p 728

cancellation. As an engineer recalled: "[Chelomey] was obsessed with the recent meetings at the test site and very upset about our failure. He blamed the latter mostly on Ustinov, for whom he found some choice epithets."³⁵

True to Chelomey's ambitious disposition, he took the opportunity of Khrushchev's visit to Tyura-Tam to propose a new project—one that was far more adventurous than the UR-200 or any other ICBM. Before coming to the launch site, he had his assistants prepare colorful models and posters of his new conception, ready to unveil it in front of the gathered military-industrial complex of the Soviet Union. This opportunity came during a visit of the Khrushchev entourage to the first launch pad for the UR-500 ICBM. All those assembled were clearly awed by the beauty and grace of a full-size mock-up of the new booster, one that was being developed to launch the first Soviet cosmonauts around the Moon. Construction had also begun on two huge silos for the UR-500, possibly the largest missile silos anywhere in the world. Chelomey then unveiled a model of the two-stage UR-500, removed its payload, and put a third stage on top of it, stating that such a model would double the lifting capability of the rocket. Khrushchev pointedly asked, "Why not make a three-stage rocket from the beginning?"³⁶ Chelomey replied that he preferred developing rockets gradually, step by step, to ensure the greatest possibility of success; it was a pointed attack at Korolev's "all-up" testing idea for the NI. When Khrushchev, visibly pleased with Chelomey's diligent ways, asked Chelomey what the next step was, Chelomey unveiled a beautifully illustrated poster of his new proposal, the giant UR-700 booster. Dementyev, Smirnov, and Ustinov watched in stunned silence as Chelomey pointed to a drawing of the 4,500-ton heavy-lift launch vehicle that could send Soviet cosmonauts to the Moon.

The UR-700 booster, a multistage behemoth, emerged from 1963 to 1964 at OKB-52, partly as a result of Chelomey's strong belief that the NI was a technically inferior competitor to the Saturn V. He had argued over and over that the combination of Earth-orbit rendezvous and lunar-orbit rendezvous for the NI was technically dubious at best, that its development program was flawed, and that its design itself was haphazard. In his opinion, Korolev had little chance to "beat" the Americans to the Moon with the NI. What was needed was a larger booster capable of direct ascent to the Moon and back, something that would dwarf the Saturn V, and something that was designed on the basis of existing missiles such as the UR-500 to shorten development problems. This competitive proposal was the most ambitious attack on Korolev that Chelomey had ever mounted. This sort of chaotic design process, whereby *already* approved programs such as the NI lunar landing project were threatened by continually new emerging proposals, was uniquely symptomatic of the Soviet piloted space program.

Chelomey explained to Khrushchev that with his UR-700, the Soviet Union could reach the Moon with less money and in less time than with Korolev's NI. Khrushchev, swayed by the dazzling presentation, asked Chelomey to prepare the necessary technical documentation while he instructed Military-Industrial Commission Chairman Smirnov to draw up the necessary decree ordering a high-level comparison of the merits of the NI and UR-700 lunar landing proposals. A commission would examine the two projects and make a final decision.³⁷

Khrushchev and the others also visited with Korolev during their short visit. On the first day, with his guests viewing, Korolev had launched a Zenit-2 reconnaissance satellite into

35 Khrushchev *Khrushchev on Khrushchev* p 123 The ninth and last UR 200 missile was launched on October 23 1964

36 Sergey Khrushchev *Nikita Khrushchev krizisy i rakety uzglyad iznutri* tom 2 (Moscow Novosti 1994) 493-94 Zakhaiov "Operation Kedr or How the Proton Was Saved" V Petrakovand I Afanasyev " Proton Passion" (English title) *Aviatsiya i kosmonavtika* no 4 (April 1993) 10-12

37 Khrushchev *Nikita Khrushchev tom 2* p 494 Khrushchev interview October 10 1996

orbit.³⁸ Khrushchev visibly perked up on a visit to the assembly-testing building where the Voskhod ship was being mated to its IIA57 booster. He was also shown a mock-up of the Vykhod EVA-equipped spacecraft by cosmonauts Cagarin, Belyayev, and Leonov. The latter ably demonstrated how a cosmonaut would be able to exit and return to the spacecraft in orbit. There was also a successful launch of the much-delayed R-9A ICBM. Korolev had been informed of Chelomey's surprise lunar landing proposal before Khrushchev's visit to Tyura-Tam, but he seemed not to have been perturbed by it at the time.³⁹ The NI program was well into its hardware-building stage, and despite its problematic genesis, it did have the support of Brezhnev, Smirnov, and especially Ustinov. Stressed by the state visit, the fate of his R-9A ICBM, the threat of Chelomey's UR-700, and various other issues, Korolev was working at his most strained level.⁴⁰ In a letter to his wife written immediately after the state visit, Korolev stated:

*I passed these days as if I was in some sort of a toxic furnace. In essence all of our work of the past years was subjected to a review of effectiveness, and it wasn't only our firm but others also. Fortunately everything worked out extremely well and I am in a good mood. Tomorrow we start back up again with our usual work program*⁴¹

The "usual program" was, of course, the Voskhod launch.

Three Men in a Capsule

There were numerous glitches as engineers counted down the days to the two Voskhod launches—one an automated test and one with a crew aboard. On September 29, Voskhod lead designer Frolov reported that the fastening bolts for the Elbrus couches were three millimeters out of alignment with the corresponding holes. The shell of the vehicle had apparently deformed during the flight from Kaliningrad to Tyura-Tam. During the same afternoon, the Trai-IP telemetry instrument on the spacecraft had failed. Chief Designer Aleksey F. Bogomolov, from the Experimental Design Bureau of the Moscow Power Institute, confirmed at the regularly scheduled State Commission meeting that the entire spacecraft would have to be completely dismantled and the suspect part replaced and tested, delaying the flight by a week. The fifty-one-year-old Bogomolov was not a new participant in the space program. It was in fact he who had provided the telemetry equipment for the first Sputnik launcher. He also directed the design of radio systems, on-board data recorders, telemetry systems, TV systems, and antennae for the ground communications segment. Despite his clearly significant contributions, for inexplicable reasons, his influence and earned respect were marginal at best. He had been perhaps unfairly blamed for the Sputnik 3 failure to detect the van Allen radiation belts, and with the latest Voskhod malfunction. Korolev tore into him during a meeting on October 5. Bogomolov desperately tried to defend his position for an hour. Kamanin commented that:

38 This was Zenit 2 no 43 which was launched by an 8A92 launch vehicle. It was named Kosmos 46 upon entering orbit. See Zakharov "Operation Kedr or How the Proton Was Saved"

39 That Korolev was cognizant of the UR 700 proposal is indicated in Kamanin's diaries in a description of a conversation between Korolev and Kamanin on September 14, 1964. Kamanin wrote "In Sergey Pavlovich's opinion a Moon orbit using Chelomey's UR 500 rocket would be impossible without intermediate docking. Korolev said that he asked Chelomey to work on the docking procedure but the latter decided to make a new rocket the UR 700 which would make it possible to avoid docking in space." See Kamanin "I Would Never Have Believed Anyone" Kamanin Skryhy kosmos 1964-1966 pp 84-91

40 Sergey N. Khrushchev states that the R-9A program was actually terminated at the time being reacted only after the fall of Khrushchev. See Khrushchev *Nikita Khrushchev* tom 2 p 492

41 Colovanov Korolev p 740

all of [Korolev's] carryings-on are no longer as effective as they used to be three or four years ago. Korolev was going over the edge, and he did not want to understand that the main reason for the shortcoming and mistakes lay in the absence of a firm *plan*.⁴²

The possibility of a Voskhod launch to a great degree still depended on further drop-tests of the descent apparatus to verify the new parachute-reactive system. Underlining the importance of the exercise, Korolev visited Feodosiya on October 5 to observe the test himself along with his old cohort Flerov. Korolev flew in by airplane to Crimea, then directly transferred to a helicopter, which would escort the An-12 aircraft that would drop the sharik. Despite cloudy conditions, he was able to view the complete landing sequence as the engines under the parachute fired to slow the capsule down to almost zero velocity.⁴³ With the success behind him, Korolev flew back to Tyura-Tam on October 6, in time for the launch of the first 3KV vehicle, spacecraft no. 2, into orbit. The launch took place at 1000 hours Moscow Time on October 6, 1964. Upon entering a 177- by 413-kilometer orbit inclined at 64.77 degrees to the equator, the spaceship was designated Kosmos-47 to disguise its true mission. The spacecraft remained in orbit overnight while ground controllers tested various systems. There were no major anomalies during the mission, and the descent apparatus with its three mannequins safely landed by parachute on October 7 after a one-day, eighteen-minute flight. High-powered winds dragged the capsule about 160 meters from the landing point, but a crew on board would not have had to endure such an ordeal because they could have manually detached the parachute."

The results of the Feodosiya tests, combined with the successful Kosmos-47 mission, allowed the State Commission to move ahead with a concrete launch schedule for the crewed flight. The commission, under Tyulin's chairmanship, met on October 9 to discuss final technical issues. A pestering problem during ground testing of the RD-0108 third-stage engine was attributed to problems with the test stands. Lt. General Kamanin at this time formally proposed the Komarov-Feoktistov-Yegorov crew for launch, and the commission members unanimously confirmed the choice. The cosmonauts themselves were present during the meeting: Korolev, Gagarin, Tyulin, Rudenko, and others wished them good luck on their flight. The launch was set for the morning of October 12.

Trouble struck on October 11, the night before the scheduled launch, when Chief Designer Bogomolov arrived at Korolev's office with news that there was an additional problem with the Tral-IP telemetry system, which would require the replacement of the transmitter (a delay measured in minutes). Korolev, under stress, completely lost his temper and humiliated Bogomolov in front of Tyulin, Rudenko, Kamanin, and others. Kamanin recalled:

That report enraged Korolev. He called Bogomolov a "cowardly gutter snipe" and *announced*: "I don't want to have anything more to do with you. Go away — I can't even be in the same room with you!" It was a very uncomfortable scene. . . . With that outburst of rage, Korolev toppled himself from his pedestal as a *talented* organizer into the mire of petty passions. In four years of joint work, that was the first time I had ever seen him in such a state. I was sad and sorry for Sergey *Paulovich* [Korolev]. It was 15 minutes before he was able to calm himself down and coherently report tomorrow's flight to *Ustinov* by *telephone*.⁴⁴

42 Kamanin "I Would Never Have Believed Anyone"

43 Colovanov *Korolev* p. 741

44 Note that the apogee (413 kilometers) for Kosmos 47 was much higher than originally planned for the Voskhod mission (240 kilometers). At some point after issuing the draft plan, there was probably a modification to the planned orbital parameters. There was also a 10 percent decline in third stage engine operation for three seconds during the ascent to orbit. The engine regained full thrust mode soon after and the spacecraft reached the desired orbit. See Kamanin *Skrytyy kosmos 1964-1966* pp. 96-97.

45 Kamanin "I Would Never Have Believed Anyone"

The fault was quickly repaired, and the launch did not have to be delayed.

There was a brief State Commission meeting on the chilly but clear morning of launch day. October 12, held only 200 meters from the launch pad. All the chief designers declared the ship ready for launch. The bus carrying the three cosmonauts arrived at the pad at 1015 hours local time. The crew were dressed in lightweight, gray woolen trousers and shirts and light blue jackets. Each had a headset with attached earphones and microphones. Tyulin, Korolev, Gagarin, and others saw the three men up to the elevator before the cosmonauts took the elevator up to their ship. At the top, the crew removed their jackets and boots, donned slippers, and entered the spacecraft: Yegorov first, then Feoktistov, followed by Commander Komarov. The tension was higher than perhaps any other mission since Gagarin's flight. Without a viable launch escape system during the first minute or so of the mission, there was absolutely no way that the crew could be saved in case of booster failure. Korolev was apparently so nervous that he was shaking.



from left to right. Vladimir Komarov, Boris Yegorov, and Konstantin Feoktistov, the crew of the first Voskhod spacecraft, make their way to the launch pad on October 12, 1964, prior to the launch. Note their casual attire, a contrast to the bulky suits worn on the earlier Vostok flights. (files of Peter Corin)

The Voskhod spacecraft, 3KV no. 3, lifted off the pad at site I at exactly 1030 hours. 1 second Moscow Time on its 11A57 booster. On board were Lt. Colonel Vladimir M. Komarov (thirty-seven years old), Konstantin P. Feoktistov (thirty-eight), and Boris B. Yegorov (twenty-six), representing the Soviet Union in yet another "space spectacular." Controllers watched the booster take off, and there was a final collective sigh of relief once the clocks reached T+523 seconds: Voskhod had achieved orbital velocity and the launcher had worked without a flaw. Initial orbital parameters were 177.5 by 408 kilometers at 64.9 degrees, exactly as planned. Once again, the reaction from the West was unprecedented, prompting another round of discussions on Soviet plans to go to the Moon.⁴⁶ Following orbital insertion, there was the customary conversation with Presidium members Khrushchev and Anastas I. Mikoyan, as well as greetings transmitted to the participants of the Tokyo Olympic Games.

Each member of the Voskhod crew was trained to perform his own individual tasks during the daylong mission. Komarov, as crew commander of the flight, had overall responsibility for the functioning of the vehicle's systems. Among his specific duties was the operation on the sixth and seventh orbits of a set of electrostatic ion engines installed on the exterior of the ship. According to the Soviets, this was the first occasion when such engines were tested during orbital flight. Feoktistov carried out a number of visual, photometric, and photographic observations of Earth and its atmosphere, the polar aurora and luminescent particles, and azimuthal and stellar backgrounds for navigational and orientation purposes." At several points during the

46. See, for example, *Soviet Space Programs, 1962-65. Goals and Purposes Achievements, Plans, and International Implications*, prepared for the Committee on Aeronautical and Space Sciences, U.S. Senate, 89th Cong., 2d sess. (Washington, DC: U.S. Government Printing Office, December 1966), pp. 384-86.

47. George Wukelic, ed., *Handbook of Soviet Space-Science Research* (New York: Gordon and Breach Science Publishers, 1968), p. 59; G. V. Petrovich, ed., *The Soviet Encyclopaedia of Space Flight* (Moscow: Mir Publishers, 1969), p. 124. Note that the presence of ion engines was not described in the original draft plan.

flight. he described "luminous particles" outside the porthole, very similar to the famous "fireflies" observed by NASA astronaut John Glenn during his mission in 1962. An unnamed sextant was also used by Feoktistov as part of an experiment to accurately measure the elevation of the stars relative to the horizon.

The most extensive on-board research was focused on biomedical tests. For such a short and conservative mission, the breadth of the medical experiments was quite impressive. The *Polinom* instrument carried aboard the ship was used for carrying out several functional tests. These included: a series of eye movements in a predetermined sequence before and after ten turnings of the head while recording electro-oculograms; periodic closing and opening of eyes during the recording of electroencephalograms; and rhythmic pressing with the hand of a constant force for a duration of one minute, whose results were recorded by a dynamograph. The cosmonauts also carried out a test to measure the coordination of movements while writing four complex spirals, four figures of "6," and a signature with their eyes open and closed. The results were measured by an electromagnetic transducer. Yegorov, the first trained medical doctor in space, actively participated in seven areas of medical experiments:

- Observation of the condition and behavior of the crewmembers
- Research on tactile, pain, and tendon reflexes
- Observation of oral activity
- Psychophysiological tests to determine the rapidity and accuracy of processing data by using correction tables
- Measurement of arterial pressure
- Determination of thresholds of sensitivity to adequate and inadequate stimuli
- Determination of the acuteness of vision and fusion capabilities of the eye muscles

In addition, he took blood samples. Apart from the crew, other biological specimens carried in the ship included human cancer cells, amnion and human fibroblast cells, frog ova and sperm, *drosophila* insects, *tradescantia melanogaster* plants, winter wheat seeds, pine seeds, algae, and two types of bacteria." *Drosophila* were carried on most of the piloted missions because they multiply so rapidly that the effect of microgravity and radiation on successive generations could be observed.

The extremely shortened training program for Feoktistov and Yegorov showed through in their reactions to weightlessness. Within two to three hours of the launch, both began to experience disorientation in space. Yegorov felt as if he was bent over face downward, while Feoktistov actually felt he was upside down. Although the sensations apparently did not impair their ability to work, both suffered these feelings throughout the entire length of the mission — an anomaly that had not been detected on any of the earlier Soviet space missions. Both cosmonauts also felt dizzy when they moved their heads sharply. It seems that Yegorov had been more afflicted, with his unpleasant sensations peaking about seven hours after launch."

The short mission proceeded without much incident. On the sixth and seventh orbits, the on-board Topaz TV camera beamed down live pictures of the crew to the control center.

48 Yu M Volynkin I T Akulinichev P V Vasilyev A D Voskresenskiy I I Kasyan and D G Maksimov 'Some Data on the Condition of Cosmonauts During the Flight of the Voskhod Spaceship' (English title) *Kosmicheskiye issledovaniya* 4 (September–October 1966) 755–67 Wukelic ed Handbook of Soviet Space Science Research pp 346–48

49 Volynkin et al "Some Data on the Condition of Cosmonauts" P V Buyanov V V Kovalev V G Terentyev Ye A Fedorov and G F Khlebnikov 'Results of Medical Examination of the Crew of the Space Ship Voskhod Before and After Its Flight' (English title) *Kosmicheskiye issledovaniya* 4 (January–February 1966) 151–55

Communication with the cosmonauts was supported only by the Signal VHF transmitters because the UHF transmitters were not operational, due to interference from Earth's radiation belts. There was a communications blackout for six orbits, from the eighth to the thirteenth orbits, but when controllers regained contact, all the parameters aboard the ship were within acceptable ranges. The only anomalies on the flight involved minor issues. During the first six orbits, the temperature inside the ship rose from fifteen to twenty-one degrees Centigrade, suggesting some sort of component overheating. Later on the seventh orbit. Lt. General Aleksandr N. Babychuk, the Chief of the Air Force Medical Service, raised some alarm when telemetry showed that Yegorov's pulse had fallen to forty-six while he was asleep! In panic. Kamanin asked Komarov to verify the value, and the latter reported that Yegorov's pulse was sixty-eight. This was later confirmed by other telemetry."

The mission was set to last exactly one day, but as Korolev was ready to give the order to deorbit. Komarov evidently felt more adventurous:

Korolev: Are you ready to proceed to the completion of the final part of the program?

Komarov: The crew is ready. But we would like to prolong the flight.

Korolev: I read you, but we had no such agreement.

Komarov: We've seen many interesting things. We would like to extend the observations.

Korolev: "There are more things in heaven and earth. Horatio, than are dreamt of in your philosophy." We shall go nevertheless, by the [original] program."

With the quote from Shakespeare's Hamlet. Korolev ordered the cosmonauts to begin preparing for descent on the seventeenth orbit. As with several of the Vostok missions, there was no communication during the descent because of the failure of the short-wave transmitter, and controllers awaited tensely as the critical minutes passed by. No doubt, images of the smashed descent apparatus at Feodosiya passed through Korolev's mind. As the clock counted down, the chief of the Air Force search service finally radioed that one of his helicopter pilots had seen the capsule coming down by parachute at the designated area. There was a final report that the helicopter pilot was in visual contact with the Voskhod spacecraft, which was lying safely on the ground: all three of its passengers were outside waving at the search team. There was thunderous applause at the control room. Korolev was beyond relief:

Is it really true that it's all over, and that the crew has returned from space without a single scratch? I would never have believed anyone that the Voskhod could be made out of the Vostok, and that three cosmonauts would fly it into space. . . .⁵²

The men landed successfully 312 kilometers northeast of the town of Kustanay in Kazakhstan on October 13. The flight had lasted one day, seventeen minutes, and three seconds.

The cosmonauts were first flown to Kustanay, where they were scheduled to speak with Khrushchev on the telephone, but Military-Industrial Chairman Smirnov sent a message asking

50. Kamanin. "I Would Never Have Believed Anyone . . ."; Kamanin. *Skrytiy kosmos 1964-1966*, pp 102-03.

51. There are many different accounts of this exchange between the cosmonauts and Korolev. Some sources suggest that Korolev did not finish the quote from Shakespeare. See Nicholas Daniloff, *The Kremlin and the Cosmos* (New York: Alfred A. Knopf, 1972), p. 161; Evgeny Riabchikov, *Russians in Space* (Moscow: Novosti Press Publishing House, 1971), p. 209. Other sources suggest that Korolev *did* complete the phrase. See Colovanov, *Korolev*, p. 743. Another source claims that it was Feoktistov, not Komarov, who made the request for the extension. See Aleksandr Romanov, *Korolev* (Moscow: Molodaya gvardiya, 1996), pp. 474-75. Finally, one source suggests that Korolev never even quoted Shakespeare. See Chertok, *Rakety i lyudi*, p. 248.

52. Kamanin. "I Would Never Have Believed Anyone. . . ."

them not to wait and to fly directly back to Tyura-Tam. Although the three cosmonauts felt slightly fatigued, they were fit enough the next morning to give full postflight reports to a rapt audience of 200 individuals, including the State Commission. A lunch followed with boisterous toasts raised not only to the cosmonauts, but also to Korolev and those who had prepared the flight. It was late the same day when Korolev, Kamanin, and others first got wind of the monumental changes back in Moscow. News had come in that there would be a special meeting (Plenum) of the Central Committee the same evening, a complete surprise to the chief designers. By the morning of October 15, it was all clear: Khrushchev was no longer in power and had been replaced in his two posts by Aleksey N. Kosygin (Chairman of the Council of Ministers) and Leonid I. Brezhnev (First Secretary of the Central Committee). Kamanin had already been instructed to change the cosmonauts' prepared speeches: instead of saluting Khrushchev, they would salute Brezhnev and Kosygin." Thus, in a twist worthy of Orwell, Khrushchev's name was scratched out and Brezhnev and Kosygin scribbled in. It was the end of one era and the beginning of another, not only for the Soviet space program but for the entire nation.

Khrushchev's Twilight

Nikita Sergeyevich Khrushchev was one of the most important political figures in the origin and emergence of the Soviet space program. More than any other Soviet leader since, he developed and nurtured the kind of personal relationships with the leading space chief designers that fostered a space era driven less by institutions than personalities. Institutions, of course, existed to administer and support his agenda. In particular, he was responsible for shifting the burden of directing missile and space program policy from the government to the Communist Party.⁵⁴ By introducing the specific post of Secretary of the Central Committee for Defense and Space in July 1957, Khrushchev effectively laid the blueprint of strict Party control over the space program, which lasted until the early 1990s. He successfully populated both Party and government positions with individuals such as Brezhnev, Kozlov, Ustinov, Nedelin, and Smirnov, who could be counted on to support his radical shift in military strategy from conventional armaments to ballistic missiles. There is no question that without this firm change in direction, a rethinking for which Khrushchev was singularly responsible, the Soviet space program might have been a pale imitation of what it really was. As funding for the ICBM programs grew to astronomical levels, the space program, being merely an arm of it, rode its coattails to glory for the cause of the Soviet state.

In the historiography of the Soviet space program, Khrushchev has been bestowed a character often approaching levels of caricature. This was to a great degree reinforced by his unwaveringly loud and often crude outbursts in the public eye—pronouncements that extolled the raw power of socialism against the capitalist world. Western historians have generally depicted a simple two-sided process, with the "reckless" Khrushchev always interfering with the apolitical "dreamer" Korolev. In this scenario, the former was always craftily manipulating the latter into meaningless circus extravaganzas, thus diverting talents from more worthy endeavors. The "manipulation paradigm," however, is far too simplistic a viewpoint to stand up to serious historical scrutiny. Khrushchev's policy on the space program largely depended on his support for the concurrent ICBM program—that is, the former was funded to the extent that it did not infringe on the latter. This is not to say that he did not use the space program as a propaganda playground not only abroad, but also to curb off his political opponents within the Soviet Union.

⁵³ *Ibid*

⁵⁴ William P. Barry "The Missile Design Bureaus and Soviet Piloted Space Policy 1953-1974" draft of University of Oxford Ph D. diss. 1995

Many of his speeches from the era clearly draw attention to his role in the successes of the space program. But this self-congratulatory prose did not take away from the fact that he was not particularly interested in micro-managing space policy in a manner that Western historians have attributed to him. Contrary to accepted notions, Khrushchev never ordered Korolev to launch anything because of a personal whim. The power came from implicit threats of support, which he had the power to cut off. In this respect, his personal relationships with Korolev, Chelomey, and Yangel over missiles



Soviet leader Nikita Khrushchev appears in this photo probably dating from the Vostok 3/4 mission in August 1962. During his visit to the Simferopol control center in Crimea, he personally spoke to both cosmonauts Nikolayev and Popovich in orbit. On the right is Maj. General Pavel A. Agadzhanov, the lead "flight director" of Soviet piloted space missions in the 1960s (copyright Sergey N. Khrushchev)

were, in fact, far more important determinants of the space program's direction.

Khrushchev met all three for the final time in late September 1964 during his first and only visit to Tyura-Tam as part of Operation *Kedr*. His final brush with the space program was on the very last day of his reign. As was customary after each major space launch, a leading minister or general would call Khrushchev from the test range to inform him that such and such launch had gone off successfully. In the sycophantic world of Soviet Party politics, this was an honor that was literally fought over. On the day of the Voskhod launch, the phone call never came. The wheels of power had already begun to move ahead with the secret overthrow. After about forty minutes without word from Tyura-Tam, Khrushchev had an aide call Military-Industrial Commission Chairman Smirnov. Khrushchev's son later described their conversation:

"Comrade Smirnov," he began, restraining himself, "what's going on with Korolev's launch? Why haven't you informed me?" The irritation could be heard in his voice. Smirnov must have answered that the launch had gone as planned. . . . "Then why didn't you inform me?" The irritation was turning into anger. "You're obliged to report the results to me immediately." Smirnov must have said that he hadn't had time to call. Of course, he already knew everything and was in no hurry to telephone Father. For him, the change in power had already taken effect. . . . "What do you mean, you haven't had time? I don't understand you! Your behavior is disgraceful!" raged Father, judging from the reaction. Smirnov was halfheartedly trying to justify himself. "Comrade Smirnov, bear in mind that I demand more efficiency from you! It's your fault that things are getting resolved so slowly!"⁵⁵

Soon Khrushchev had a brief conversation with the Voskhod crew in orbit, by which time, completely unknown to him, the change in the leadership was almost over. Within hours, with the cosmonauts still in orbit, he was under house arrest. During ceremonies to honor the three crewmembers of the Voskhod mission on October 23, Khrushchev, on a whim, got into his automobile and ordered his driver to take him to his dacha. The fact that Khrushchev was going in the direction of the public ceremonies was relayed immediately to Brezhnev, who was in the midst of the function at Red Square. Seen on TV by millions, Brezhnev's face darkened at the realization that Khrushchev might be heading to Red Square to cause a public scene with the

55 Khrushchev. *Khrushchev on Khrushchev*, pp 129-30

new leadership. Aides were sent scurrying off to telephones, until they discovered that Khrushchev was indeed heading for his dacha." It was his last brush with the workings of the Soviet space program. He died, exiled from his past, on September 11, 1971, at the age of seventy-seven.

Ustinov, Smirnov, and Afanasyev

The immediate post-Khrushchev leadership was one characterized by a relative dilution of leadership responsibilities: power was spread out between the Communist Party and the government. As one Western analyst put it, "Khrushchev's simultaneous assumption of Party and government leadership was unacceptable to his successors, who restored the principle of collective leadership." In the new Brezhnev-Kosygin era, at least initially, questions of policy were influenced by a set of checks and balances between the two arms of the Soviet state:

It [was] unlikely that a single official at the Politburo or other high-level would be able to intervene successfully and systematically without risking the combined wrath of his peers. This was one of the key charges leveled against Khrushchev.⁵⁸

This new "collective leadership" had deep repercussions for piloted space policy in the post-Khrushchev era. In the new climate, the lines of *de facto* authority and power among the competing designers were much less clear after 1964 as a result of the diffusion of power among their chief sponsors. By the end of 1965, within a year of Khrushchev's fall, a triumvirate of individuals rose to the top of the space and missile programs, and they each had varying motivations that drove these sectors for the next two decades.

Prior to Khrushchev's ouster in October 1964, there had been much discussion among the leadership on creating a new governmental entity to administer and manage the space and missile programs. Through the late 1950s and early 1960s, this function had been undertaken by the State Committee of Defense Technology, the "ministry" that had inherited ballistic missile development from the post-World War II era. Originally, the Seventh Chief Directorate within the State Committee carried out the management of the missile and space programs. Other directorates focused on weaponry, such as tanks, artillery, small arms, and ammunition. The Seventh Chief Directorate had clearly outgrown its initial mandate, and using it as a base, it seems that Khrushchev wanted to focus all missile and space-related design and production in a new "ministry." By the time this entity was formed, Khrushchev was out of power. In a move designed to reverse Khrushchev's drastic and failed decentralization attempts in the late 1950s, the new Brezhnev-Kosygin leadership recreated the centralized ministry system by official order on March 2, 1965.⁵⁹ Six State Committees concerned with weaponry were renamed ministries, while a seventh, the Ministry of General Machine Building, was created on the basis of the old Seventh Chief Directorate.⁶⁰

The Ministry of General Machine Building, more commonly known by its Russian abbreviation "MOM," became the center of all missile and space-related design and production activ-

56 *ibid* p 173

57 Arthur J Alexander "Decision Making in Soviet Weapons Procurement" *Adelphi Paper* 147-48 (Winter 1978/19) 6

58 Peter Almquist *Red Forge Soviet Military Industry Since 1965* (New York: Columbia University Press 1990) p 75

59 McDonnell "The Soviet Defense Industry as a Pressure Group" p 90

60 Yu Mozhgorin and A Yerenko "From the History of Space Science From the First Ballistics to II" (English title) *Aviatsiya i kosmonavtika* no 8 (August 1991) 34-35 N Tarasenko "Space Economics Achievements Problems Prospects S Afanasyev "The Rain of Gold is a Myth" (English title) *Ekonomika i zhizn* 16 (April 1991) 6-7

ity in the Soviet Union. Whereas before, space and missile design bureaus, scientific-research institutes, and production plants were scattered among various ministries, the establishment of the new ministry was a giant step forward in knocking down bureaucratic walls by bringing them all together under one roof. MOM had official jurisdiction over almost all Soviet entities involved in the design, experimental production, and serial production of long-range ballistic missiles, space launch vehicles, artificial satellites, piloted spacecraft, liquid-propellant rocket engines, launch complexes, and guidance and control systems." Curiously, one important element of the space program was not brought into MOM at the time, thus being the source of serious problems later. As one leading administrator later recalled:

... with respect to rocket-space radio-electronics we quickly fell behind since micro-electronics and radio-electronic technology remained outside of the influence of the MOM, instead remaining within the [Ministry of Radio Industry] and [Ministry of Electronics Industry]. . . . As a result, it was a great inconvenience to satisfy the MOM's demands for modern electronic equipment, and ultimately our [country's] space radio-electronic technology began to lag behind that of the Americans in terms of development periods, quality, and general scientific-technical level."

Among those actively involved in the piloted space program, the design bureaus and institutes that were brought into MOM were:

- From the State Committee for Defense Technology:
 - GSKB SpetsMash (V. P. Barrnin)
 - OKB-456 (V. P. Glushko)
 - OKB-2 (A. M. Isayev)
 - OKB-1 (S. P. Korolev)
 - NII-88 (Yu. A. Mozzhorin)
- From the State Committee for Aviation Technology:
 - OKB-52 (V. N. Chelorney)
 - OKB-154 (S. A. Kosberg)
- From the State Committee for Radio Electronics:
 - Scientific-Research Institute of Radio Instrument Building (M. S. Ryazanskiy)
 - Scientific-Research Institute of Automation and Instrument Building (N. A. Pilyugin)
- From the State Committee for Ship Building:
 - NII-944 (V. I. Kuznetsov)⁶¹

61. There was apparently considerable resistance to transferring the guidance systems entities to MOM from their original positions within the Ministry of Radio Industries. See Mozzhorin, *et al.* eds., *Dorogi v kosmos* I, pp. 44–45.

62. Yu. A. Mozzhorin, *et al.*, eds., *Nachalo kosmicheskoy ery: vospominaniya veteranov raketno-kosmicheskoy tekhniki i kosmonavtiki vypusk vtoroy* (Moscow: RNITsKD, 1994), p. 288. The comment is by L. I. Gusev, who briefly served as a deputy minister of MOM in 1965.

63. The remaining design bureaus and institutes of the Soviet space/missile program—that is, those that had little or no involvement in piloted spaceflight—were spread out over various ministries. They included: SKB-385 (V. P. Makeyev) and OKB-10 (M. F. Reshetnev) in the Ministry of General Machine Building (MOM); OKB-117 (S. P. Izotov), OKB-276 (N. D. Kuznetsov), OKB-300 (S. K. Tumanskiy), and OKB-124 (G. I. Voronin) in the Ministry of Aviation Industry (MAP); NII-627 (A. G. Iosifyan) in the Ministry of Electronics Industry (MEP); NII-1 (A. D. Nadiradze) and NII-125 (B. P. Zhukov) in the Ministry of Defense Industry (MOP), and OKB-41 of KB-1 (A. A. Raspletin and A. I. Savin) in the Ministry of Radio Industry (MRP).

The new ministry itself had several functional divisions formally called chief directorates, each one dedicated to a particular aspect of the space and missile industry. These thematic divisions included strategic missiles, space vehicles, liquid-propellant rocket engines, guidance systems, and launch complexes. "The development of piloted spacecraft seems to have been limited to the Third Chief Directorate, which probably functionally included both the Korolev and Chelomey design bureaus."⁶⁵

The man appointed to lead the new ministry was a surprise: forty-seven-year-old Sergey A. Afanasyev, an individual who was *not* one of the many experienced deputies from the old State Committee for Defense Technology expecting a promotion. Afanasyev had an interesting background, heading various "technical directorates" in Ustinov's Ministry of Armaments through the 1950s. Although Afanasyev was one of the famous "Ustinov group" who rose to important national positions by the early 1960s, it seems that he made a break from his main sponsor sometime soon after. This may have had something to do with an incident in 1952 when Afanasyev was in danger of being shot by Beriya's henchmen because of problems with engine production. Ustinov did not bother to defend the young Afanasyev, and the latter was only saved when one of Ustinov's deputies risked his career for him. "Afanasyev left Ustinov's ministry in 1957, rising to become the chair of the All-Russian Council of the National Economy in June 1961, where he became primarily responsible for managing the defense economy. His appointment to head MOM seems to have been a move made to put a check on Ustinov's grip on the defense industry, and in particular the space program. Afanasyev had, by then, aligned himself not with Ustinov, but with Marshal Andrey A. Grechko, the Deputy Minister of Defense.

Most of those who remember Afanasyev recall someone with whom one should not trifle. A scientist later wrote:

*[Afanasyev] was a huge man with large, sturdy hands, like "a hammer striker," we said. When he chaired a meeting, the figure of the minister induced fear. His sentences for employees of the ministry, whether they were general designers or simple engineers, were brief and ruthless. . . . I was told that the man was vindictive and had a very long memory. Members of his team secretly referred to him as "the Big Hammer."*⁶⁶

⁶⁴ Not all the chief directorates and their specific functions have been identified. A pre glasnost account identified four chief directorates in MOM—for ground equipment, for rocket engines, for guidance and control systems, and for missiles. See Alexander "Decision Making in Soviet Weapons Procurement," p. 22. Almquist, *Red Forge*, pp. 144–45. There were at least thirteen chief directorates in MOM by 1985.

⁶⁵ The First Chief Directorate of MOM included OKB 10 and MZ Khrushchev; the Second Chief Directorate included OKB 456 and NII 1; the Fourth Chief Directorate included GSKB SpetsMash and the Progress Plant; and the Fifth Chief Directorate included NII Priborostroyeniya and NII AP.

⁶⁶ For Afanasyev's own account of the event, see Mozzhorin et al., eds., *Dorogi v kosmos I*, pp. 40–42.

⁶⁷ Roald Z. Sagdeev, *The Making of a Soviet Scientist: My Adventures in Nuclear Fusion and Space From Stalin to Star Wars* (New York: John Wiley & Sons, 1993), pp. 198–99.



This is the official portrait of Minister of General Machine Building Sergey Afanasyev. He served in that capacity from 1965 to 1983, during which time he managed the Soviet ballistic missile and space programs. (files of Peter Gorth)

Afanasyev had one First Deputy Minister, Georgiy A. Tyulin. Korolev's old friend and the former artillery officer who was concurrently the chair of the *ad hoc* State Commission for Voskhod. The fifty-one-year-old Tyulin might have expected to head the new ministry after a distinguished and long career with good connections to both the military and the "Ustinov group," but his appointment as Afanasyev's chief deputy exemplified how latent friction was built into the space industry by that time, as different factions jockeyed for key positions. Afanasyev and Tyulin administered six deputy ministers, each with a different portfolio.⁶⁸

Afanasyev was one point of the triumvirate that would dominate the missile and space program into the 1980s. The second individual was Leonid V. Smirnov, the forty-nine-year-old chair of the Military-Industrial Commission. More commonly referred to by its Russian abbreviation "VPK," the Military-Industrial Commission was the heart of the Soviet military-industrial complex. In the mid-1960s, VPK consisted of the heads of the seven ministries involved in the design and production of military equipment: the chair of the State Planning Organ (Gosplan) responsible for budget appropriation; the commanders-in-chief of the Air Force, the Strategic Missile Forces, the Navy, and the Air Defense Forces; the deputy minister of defense for armament procurement; and the president of the Academy of Sciences. The chair of VPK was also simultaneously a deputy chair of the USSR Council of Ministers.⁶⁹

In some sense, Smirnov was the head of the Soviet military-industrial complex, overseeing the creation and manufacture of not only missiles and spacecraft, but also tanks, ships, fighter planes, bombers, helicopters, submarines, nuclear bombs, guns, cannons, and so on. Thus Smirnov was not only Afanasyev's boss, but also the boss of the remaining seven military industrial heads. What is most significant is that Smirnov had also served his apprenticeship in the space and missile industry. He was picked out by Ustinov in the late 1940s to head a research institute specializing in radar instrumentation and was launched on a spectacular career under the latter's sponsorship. Between June 1952 and March 1961, Smirnov served as the director of Plant No. 586 at Dnepropetrovsk, which was associated with Yangel's design bureau and was possibly the largest missile production facility in the world. When Khrushchev had boasted about building missiles like sausages, it was Smirnov's plant to which he was referring. The Soviet leader had been duly impressed with Smirnov's performance during a visit to the plant in 1959, and within four years, the young Smirnov had risen far ahead of contemporaries. On May 13, 1963, he was appointed chairman of VPK, replacing Ustinov, who had been "promoted" to a higher post."

68 The six deputy ministers of MOM were L I Gusev (guidance systems) N D Khokhlov (quality control) V Ya Litvinov (space and missile programs) Ye V Mazur (material technical supply) C M Tabakov (rocket engines) and C R Udarov (launch complexes) Gusev left his position in late 1965 and was replaced by M A Brezhnev. See Mozzhorin et al eds *Dorogi v kosmos* I pp 38-39 Christian Lardier *L'Astronautique Soviétique* (Paris Armand Colin 1992) p 164 Almquist *Red Forge* pp 141-45

69 In March 1965 the seven industrial ministries that were part of VPK were the Ministry of Defense Industry (S A Zverev) the Ministry of Aviation Industry (P V Dernentyev) the Ministry of Ship Building Industry (B Ye Butorna) the Ministry of Electronic Industry (A I Shokin) the Ministry of the Radio Industry (V D Kalmykov) the Ministry of Medium Machine Building (Ye P Slavskiy) and the Ministry of General Machine Building (S A Afanasyev) An eighth and ninth ministry were added in February 1968 and 1974 respectively. These were the Ministry of Machine Building (V V Bakhirev) and the Ministry of the Means of Communications (N D Psurtsev) See Alexander "Decision Making in Soviet Weapons Procurement" p 22 McDonnell "The Soviet Defense Industry as a Pressure Group" pp 90-91 Chertok *Rakety i lyudr* pp 311-13

70 Michael Tatu *Power in the Kremlin: From Khrushchev's Decline to Collective Leadership* (London Collins 1969) p 330 V Pappo Korystin V Platonov and V Pashchenko *Dneprouskiy raketno kosmicheskiy tsentr* (Dnepropetrovsk PO YuMZ/KBYu 1994) pp 54-67 70 Khrushchev's visit to the Dnepropetrovsk plant and his impressions of Smirnov are described in Sergey Khrushchev *Nikita Khrushchev krizisy i rakety uzglyad iznutri tom I* (Moscow Novosti 1994) pp 432-33

Smirnov owed his entire career to Ustinov. Within the space program itself, he was clearly in favor of Yangel's projects and then perhaps Korolev. Certainly, given Ustinov's predilection for trying to curb Chelomey's efforts. Smirnov could be expected to do the same in given situations. He was, of course, ultimately responsible to the whims of Communist Party leaders. As one Russian historian wrote: "[Smirnov] knew that prior to deciding any kind of issue, he had to clearly understand what kind of a decision was expected from higher up." Like many other "cardinals" of the Soviet military-industrial complex. Smirnov instilled total fear in his subordinates. One Russian historian wrote later: "People always found it difficult to make a report to Smirnov because his face was so impassive that it was completely impossible to see a hint of any reaction that your words might arouse in him." Smirnov's responsibilities were first detected in the West during negotiations of the first series of Strategic Arms Limitation Talks (SALT I) in May 1972. His active participation in the negotiations convinced U.S. diplomats that he was a "tough and skillful negotiator" with a "technician's grasp of the issue" superior to anyone at the table.⁷¹ Others remember him differently. Although he succeeded Ustinov as chairman of VPK, one engineer recalls that Smirnov was simply "a rote bureaucrat" who was "not as clever as Ustinov."⁷² Rote bureaucrat or not, Smirnov had the distinction of managing the entire Soviet defense industry through nearly a quarter of a century, outlasting Khrushchev, Brezhnev, Kosygin, Andropov, and Chernenko. He would not retire until the Gorbachev era.⁷³



Leonid Smirnov was the Chairman of the Military-Industrial Commission (VPK) from 1963 to 1985. He was the effective head of the Soviet military-industrial complex during that period (files of Peter Gorin).

Officially, Smirnov's VPK was "the principal coordinating body for military research, development, and production. It also [played] a key role in technical evaluations of new weapons proposals."⁷⁴ Given that the space program was simply an institutional arm of the military missile program, VPK did exactly the same for the space program. Every proposal that surfaced up from the design bureaus past ministry heads eventually ended up at the office of the Military-Industrial Commission, set deep within the fortress of the Kremlin. Because staff members of VPK composed the drafts of all defense research and development decrees, VPK's role straddled the boundaries between policy formulation and policy implementation. Even in the mid-1960s, U.S. intelligence officials seem to have been unsure of the very existence of VPK. In a top-secret brief on the Soviet space program dating from January 1965, the U.S. Central Intelligence Agency (CIA) wrote simply that "responsibility for the direction of the Soviet space program apparently rests with an unknown authority directly under the Council of Ministers." Much of the space program was still said to have been coordinated by "the Commission on the Exploration and Utilization of Cosmic Space," the 1950s-era front organization publicized by the Soviets. The CIA added that it had "been unable to identify many of the individuals responsible for research and development."⁷⁵

71. Colovanov. Korolev, pp. 668-70
 72. Alexander. "Decision-Making in Soviet Weapons Procurement." p. 20
 73. Khrushchev interview, October 10, 1996.
 74. Golovanov. Korolev, p. 670
 75. Alexander. "Decision-Making in Soviet Weapons Procurement." p. 21.
 76. U.S. Central Intelligence Agency, "National Intelligence Estimate 11-1-65 The Soviet Space Program." Washington, DC, January 27, 1965, p. 29, as declassified in 1997 by the CIA Historical Review Program

If Smirnov and Afanasyev were the managers of Soviet space policy, then Dmitriy Fedorovich Ustinov was its ultimate master. Since the formation of the Soviet rocketry industry in May 1946, he had served as the industrial manager for the Soviet ballistic missile and space program in a series of positions, culminating with his appointment as chairman of VPK in December 1957. Through the years, he had been involved on an almost day-to-day basis with chief designers such as Korolev, Glushko, and Yangel; it would not be an overestimation to say that with the exception of Korolev, Ustinov was the single most important figure in the history of the Soviet space program. His signature can be found in almost every single decree and decision of the early missile and space programs, spanning a period of almost forty years. Until 1965, Ustinov had remained a public servant of the Soviet government—that is, engaged in administering projects rather than formulating policy—and it was evidently a job at which he excelled. Sergey Khrushchev recalls that:

Ustinov was a brilliant man [but he] was very bad in strategy. He could not create a strategy . . . what to do, where to go . . . [things] like state policy or defense policy. But once he received the order from Stalin or Khrushchev to do something, he knew how to do it in the best way. When he was Chairman of the Military-Industrial Commission . . . when he received the order to do something, like putting together a decree of the Central Committee and the government on a Chelomey design, he did this in one shot. He knew how to do this.”

On March 26, 1965, soon after the establishment of MOM, Ustinov was moved from the government (that is, management) to the Party (that is, policy formulation). His new title was Secretary of the Central Committee for Defense Industries and Space, the top-ranking leader of the Soviet space program. He was also inducted as a Candidate Member of the Presidium (which was renamed the Politburo in April 1966).⁷⁸

As a secretary of the Central Committee, Ustinov was one of about a dozen individuals overseeing every sector of Soviet society as part of a smaller group called the Secretariat, roughly analogous to the Western concept of a cabinet. Officially, the Secretariat's goal was to provide "analysis and recommendations" to the members of the Politburo. In the case of the space program, however, Ustinov may have exerted a singularly powerful force that essentially laid the foundations of Soviet space policy. He decided which programs to emphasize, which directions to conduct research, how to compete with the U.S. space program, whether to time space missions for certain holidays, when and how to penalize chief designers, the appointment and dismissal of chief designers, and so forth. In Soviet publications of the time, Ustinov was said to have:

coordinated and led the work of institutions, design bureaus, [and] industrial enterprises with the goal of the most complete fulfillment of the tasks of the party and the government in the long-range strengthening of the economic and defense potential of the nation, [and he] took up active participation in organizational work in the area of the development of technology used for the research and mastery of space.”⁷⁹

There were also, of course, other *full* Politburo members with varying degrees of stake in the Soviet space program. The son-in-law of one, Andrey P. Kirilenko, was a senior engineer at

77. Khrushchev interview, October 10, 1996.

78. Edward L. Crowley, Andrew I. Lebed, and Dr. Heinrich E. Schulz, eds., *Party and Government Officials of the Soviet Union 1917–1967* (Metuchen, NJ: The Scarecrow Press, 1968), p. 84.

79. Almquist, *Red Forge*, p. 21.

OKB-1. Brezhnev himself favored Yangel, both having come from Dnepropetrovsk in the Ukraine. Ustinov was a little more shrewd in his patronage. He clearly favored Korolev throughout the latter's career, defending his proposals at critical junctures, perhaps even saving his life during the Stalin era. But while most historians do not question Ustinov's support for Korolev, it is also an inarguable fact that Ustinov was a strong supporter of Glushko. For obvious reasons, this caused complications in his relationships with both.

Little is known about Ustinov's personal life or his character. As with a number of other Soviet bureaucrats of the time, people considered him "temperamental, impulsive, and rude." MOM Minister Afanasyev, appointed to be a foil against Ustinov's bulldozing over the space program, recalled that for Ustinov, work was the only thing: "He seemed to have no other interests such as hunting or fishing."⁸¹ Others say that

He made his decisions alone. . . . After D. F. made up his mind, a commission would usually be set up to study the issue. It was composed of people who knew the boss's mind and never missed a cue. The decisions of the Central Committee and the Council of Ministers were taken after a report of the commission. The minister's personal opinion was never cited to justify this or that decision.⁸²



Dmitriy Ustinov is shown here in a photo from the mid 1960s. With the exception of Sergey Korolev, he was the single most important individual in the history of the Soviet missile and space programs. His influence was not limited to missiles and space: from 1965 to 1976 he was the ranking Central Committee secretary overseeing the entire Soviet defense industry (files of Peter Gorin)

It is known that VPK or MOM, rarely, if ever, failed to approve rulings originating from the Defense Industries Department in the Central Committee—that is, one of Ustinov's departments.⁸³

Ustinov, Smirnov, and Afanasyev were the three men who ran the Soviet space program from the 1960s on. For Ustinov and Smirnov, the space program was only part of their responsibilities; both also administered the entire Soviet defense industry as it raced to reach strategic parity with the United States. It is in itself a significant fact that the men who facilitated most of the Soviet rise to gargantuan military superpower were also both intrinsically involved in the goings on of the space program. It underlines that inseparability of the Soviet space program from military efforts and hints at the domination of former space program managers in the rule of the Soviet state.

The Ustinov-Smirnov-Afanasyev trio, part of the so-called "Ustinov group" from the armaments industry in the 1940s and 1950s, was obviously not a solid monolithic block." The changes in 1965 had one institutional effect related to the military's position on space. Several major artillery officers were moved into the Ministry of Machine Building from the Strategic Missile Forces—all of them very strong supporters of a vigorous Soviet space program. Given

80 Nina Chugunova "Notes on the Margins" (English title) *Ogonek* 4-5 (January 1993) 29-30

81 Mozzhorin et al eds *Dorogi v kosmos* I p 47

82 Chugunova "Notes on the Margins" pp 29-30

83 Stephane Chenard "Twilight of the Machine Builders" *Space Markets* 5 (1991) 11-19

84 For discussions of the "Ustinov group" see Julian Cooper "The Elite of the Defence Industry Complex" in David Lane ed *Elites and Political Power in the USSR* (Cheltenham UK: Edward Elgar 1988) pp 167-87

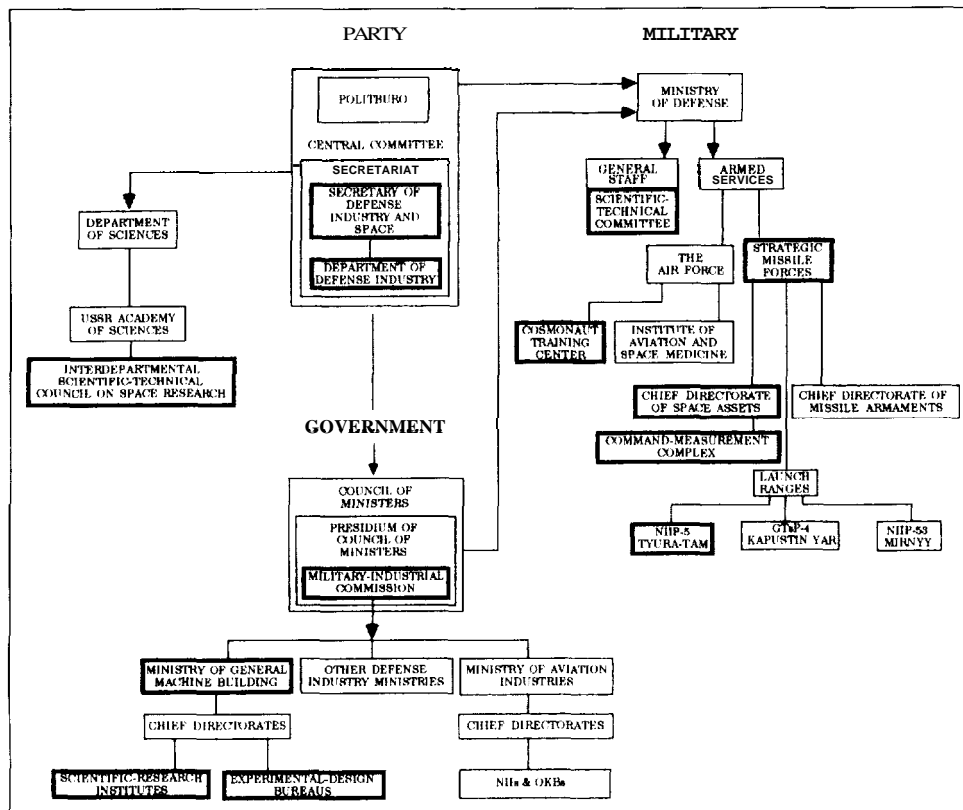

The 1965 organization of the administrative bodies in the Soviet space program (copyright Asif Siddiqi)

the cool attitude of the Strategic Missile Forces toward piloted space exploration, it is not clear whether this was done to punish the officers for their views or to infiltrate MOM to expand the influence of the Strategic Missile Forces." Given the sketchy evidence, it seems that the former was more likely than the latter. One of those "moved out" was, in fact, the Commander-in-Chief of the recently established Central Directorate of Space Assets, Maj. General Kerim A. Kerimov, whom the more "trustworthy" Maj. General Andrey A. Karas replaced." Thus, with the few

85. Barry, "The Missile Design Bureaux." Four officers of the Strategic Missile Forces have been identified in this move Lt. General G. A. Tyulin who was appointed the First Deputy Minister of MOM, Maj. General K. A. Kerimov, who was named the Chief of the Third Chief Directorate of MOM, Colonel Yu. A. Mozzhorin, who had been serving as Director of NII-88 since 1961, and Maj. General A. G. Mrykin, who was appointed First Deputy Director of NII-88 under Mozzhorin.

86. For Kerimov, see N. Kamanin, "A Coal Worth Working For." (English title), *Vozdushniy transport* 44 (1993) 8-9. See also "Col. Gen. A. G. Karas" (English title), *Krasnaya zvezda*, January 4, 1979, p. 3, in which Karas is said to have served as chief of a chief directorate in the Ministry of Defense between 1965 and 1979. The second officer, Lt. General A. G. Mrykin, had served as the First Deputy Chief of the Chief Directorate of Reactive Armaments (GURVO) since July 1955. Upon the formation of the Strategic Missile Forces, GURVO was transferred to their jurisdiction, and Mrykin had become one of the leading advocates of a stronger role for the Strategic Missiles Forces within the Soviet space program. He was next in line to command GURVO, but in August 1964, a junior officer (Maj. General A. A. Vasilyev) was picked to head GURVO. Mrykin evidently refused to work under Vasilyev, a former subordinate, and instead left the Strategic Missile Forces in March 1965 and joined the Ministry of General Machine Building's NII-88 as its First Deputy Director. Ironically, at NII-88, Mrykin ended up working for a former subordinate, NII-88 Director Yu. A. Mozzhorin. See Mozzhorin, et al., eds., *Nachalo kosmicheskoy ery*, p. 256.

space proponents out of the way, the Strategic Missile Forces were even less likely than before to support "civilian" projects such as the Moon landing. The Air Force, fighting a losing battle, did not manage to put a single representative into the Ministry of General Machine Building.

There was a final element of the 1965 shake-up—one that was motivated by allowing Soviet scientists in space research. As early as 1959, Korolev and Keldysh had been calling for the establishment of an institution dedicated solely to conducting scientific research in space, but the scientific lobby, having served as lackeys for the military-industrial complex, were simply unable to fortify their position into action. After much discussion within the Academy of Sciences, in July 1963, Keldysh fired off a specific proposal on behalf of the scientific community for the establishment of the Institute for Space Research.⁸⁷ What changed the Soviet government's mind at the time is not apparent, but it may have been motivated by the need to have a public forum to represent Soviet space scientists abroad. Because the Soviets could hardly send Smirnov or Ustinov abroad to talk about their space programs, it would be much more convenient to have a real institution to indicate that the Soviet space program was one operating as a completely separate entity from the military. The institute was formally established on July 14, 1965, under the directorship of Academician Georgiy I. Petrov, a char-smoking six-foot-tall, brilliant aerodynamics specialist who had contributed significantly to ICBM development.⁸⁸ It was officially subordinate to the USSR Academy of Sciences. Despite Petrov's best intentions, through its first few years of existence, the institute found itself mired in bureaucratic politics; different scientific communities all vied for a piece of the funding that they had all been waiting for since Sputnik. It would not be until the early 1970s that the Institute finally became a world-class institution supporting high-quality scientific research on space phenomena.

Chelomey in Trouble?

Khrushchev's fall from power had immediate and dire consequences for the beleaguered Chelomey. Propped and supported for the preceding four years by the Khrushchev administration, Chelomey all of a sudden lost his chief sponsor. Khrushchev would say many years later: "I am not ashamed to say that I gave Chelomei my support back then. He fulfilled many of the hopes we placed in him. . . ."⁸⁹ One wonders what Chelomey must have thought in the days after October 13 when Brezhnev and Kosygin assumed power. Chelomey was reportedly nervous as gossip in and around the organization reached a feverish peak on the possible future for OKB-52 and its associated branches. Still reeling from the abrupt decision to terminate the UR-200 ICBM program, Chelomey's first move was to telephone Kosygin. Brezhnev would have been a more risky proposition given his close relationship with Ustinov. Kosygin was, however, inordinately rude to Chelomey, and he refused to even discuss the possibility of reconsidering the decision on the UR-200.⁹⁰ The UR-200 ICBM program was

87 This letter has been reproduced in full as M. V. Keldysh "On the Organization of the Institute of Space Research" (English title) in V. S. Avduyevskiy and T. M. Eneyev eds. *M. V. Keldysh izbrannyye trudy raketnaya tekhnika i kosmonautika* (Moscow: Nauka, 1988) pp. 477-78.

88 Yu. I. Zaytsev "14 July—25 Years Since the Organization of the Institute for Space Research of the AN SSSR (1965)" (English title) *Iz istorii aviatsii i kosmonautiki* 64 (1990): 54-58. An official decree of the Academy of Sciences on the institute's formation was issued on July 9, 1965.

89 Nikita S. Khrushchev, *Khrushchev Remembers: The Glasnost Tapes* (Boston: Little & Brown, 1990), p. 188.

90 Khrushchev, *Nikita Khrushchev*, tom 2, pp. 514-15. The ninth and last UR-200 was launched on October 23, 1964, from Tyura Tam. See S. A. Zhiltsov ed. *Gosudarstvennyy kosmicheskiy nauchno-proizvodstvennyy tsentr imeni M. V. Khrunichyeva* (Moscow: RUSSLIT, 1997), p. 58. Mikhail Rudenko "Designer Chelomey's Rocket Planes" (English title) *Vozdushniy transport* 51 (1995): 8.

formally terminated soon after, squelching one of Chelomey's primary means to gain access to space.⁹¹

Because one of the early goals of the Brezhnev-Kosygin leadership was to "reverse" the decisions of the Khrushchev era, the entire OKB-52 came under great scrutiny. There was even talk of completely dissolving the design bureau. Several special commissions were established in October to investigate, among other things, "the value of storage materials, book-keeping, the completion of plans, [and] the observance of secrecy" at OKB-52.⁹² Everything—from the size of the carpet in Chelomey's dacha to the finances for the UR-200 program—was audited or inspected. One of the first casualties of this unusual backlash was the size of Chelomey's empire. By late 1964, he was overseeing a design bureau and branches twice the size of Korolev's OKB-1. Thus, the first order of business was to deprive OKB-52 of its branches. The most vulnerable of these was Branch No. 3 located at Khimki. This subsidiary, consisting of the old Lavochkin design bureau and its associated plant, had been tasked by Chelomey to work on anti-ship cruise missiles, such as the P-70 Ametist in the early 1960s, allowing him to concentrate on ICBMs and space programs at the central office. The winds of change were, however, too quick for Chelomey. The very day after the change of power, on October 15, the Lavochkin bureau "unofficially" separated itself from Chelomey.⁹³ Many of Chelomey's representatives, including Chief Designer Arkadiy I. Eidis, returned to Reutov with their files and work on the Ametist missile, while the original Lavochkin people found a new calling: automated lunar and interplanetary spacecraft.

For some months, Korolev had been discussing the possibility of "farming out" specific themes related to space exploration to other organizations. While his OKB-1 had developed the first piloted spacecraft, communications satellites, robotic lunar vehicles, automated interplanetary spacecraft, scientific satellites, and reconnaissance satellites. Korolev's primary interest was piloted spaceflight. To allow him to focus on piloted spaceflight without a significant distraction of time and resources, Korolev separated three space efforts from his own design bureau and transferred them wholesale to other organizations. Reconnaissance satellites went to OKB-1's Branch No. 3 at Kuybyshev in 1964, while communications satellites went to OKB-10 at Krasnoyarsk-26 in late 1965.⁹⁴ A third thematic direction Korolev considered for transfer was work on robotic lunar and interplanetary spacecraft. As soon as the employees of the Lavochkin design bureau found themselves free from Chelomey's control, Korolev began discussions on handing over all his work on the Luna, Mars, and Venera spacecraft to them. The Lavochkin group officially separated from Chelomey on March 2, 1965, becoming the Experimental Design Bureau of the S. A. Lavochkin State Union Machine Building Plant. Georgiy

91 The "official" reason for the termination of the UR 200 varies in Russian literature. One source suggests that the cancellation was because of the belief that it had inferior characteristics as compared to Yangel's R 16 ICBM. See Petrakov and Afanasyev "Proton Passion." A second source suggests that the cancellation was owing to the urgency of the mission of creating a new generation of missile complex as a counterpart to the American Minuteman. The UR 200 also had deficiencies in silo defense characteristics. See Zhiltsov ed. *Gosudarstvennyy kosmicheskii* p. 58. In an official history of the Strategic Missile Forces the authors write that work on the project was terminated in connection with the successful completion of flight work and organization of military service of the R 16, R 16U and R 9A ICBMs. See Ye. B. Volkov ed. *Mezhkontinentalnyye ballisticheskiye rakety SSSR (RF) i SShA* (Moscow: RVSN, 1996) p. 139.

92 Khrushchev, *Nikita Khrushchev* tom 2 p. 515. Rudenko "Designer Chelomey's Rocket Planes" "Interview with Academician A. A. Dorodnitsyn" (English title), in Dmitriy Khrapovitskiy ed. *Generalnyy konструктор Akademik V. N. Chelomey* (Moscow: Vozdushniy transport, 1990) pp. 13–14.

93 N. G. Babakin, A. N. Banketov and V. N. Smorkalov, G. N. Babakin, *zhizn i deyatelnost* (Moscow: Adamant, 1996) pp. 29–32.

94 Semenov ed. *Raketno Kosmicheskaya Korporatsiya* pp. 101–154–155. Note that OKB-1's Branch No. 3 was technically still subordinate to the OKB-1 main center at Kaliningrad. Formal separation did not occur until July 30, 1974.

N. Babakin, a fifty-year-old radio-technical systems expert who had worked under Lavochkin for many years, was appointed the new chief designer of this design bureau. By late 1965, Korolev had handed over all work on automated deep space exploration to Babakin." Thus, by a circuitous route, the Lavochkin design bureau went from designing airplanes in 1940s, intercontinental cruise missiles in the 1950s, and anti-ship missiles in the early 1960s to finally spacecraft beginning in the mid-1960s. It would eventually become one of the most important space research organizations in the Soviet Union.

The commissions that investigated Chelomey's fortunes did not only do away with his branches, but also his works. One of the commissions, headed by Academy of Sciences President Keldysh, was tasked with assessing each and every space and missile project at Chelomey's design bureau. Among the programs threatened with cancellation were the nationwide anti-ballistic missile system known as Taran and the UR-500 ICBM/space launch vehicle; the former was simply terminated, while the latter came under severe attack. By this time, the Strategic Missile Forces were turning away from their earlier doctrine of super-heavy ICBMs to lightweight ICBMs: in this climate, the UR-500 lost its primary reason for existence. Luckily for Chelomey, the UR-500 program had strong supporters, both in the military and in the person of Academician Keldysh. The latter "firmly and persistently" argued that despite its shortcomings as an ICBM, the UR-500 would make an excellent space launch vehicle."

The reasons for Keldysh's support remain obscure even today. He was, in fact, known more for his staunch attachment to the Korolev faction through the late 1950s and early 1960s. His connections to Chelomey did, however, go back a long way, and Keldysh may have even been instrumental in the original establishment of OKB-52 in 1955. Regardless of Keldysh's ultimate motivations, one academician recalls that "[the only reason] Chelomey remained standing was owing to the intervention of M. V. Keldysh." Defended by Keldysh, Chelomey took advantage of the reprieve to quickly put together a test program for the launch of the UR-500. Originally, there had been plans to test-launch the vehicle as a two-stage ICBM, to be followed by three-stage orbital launches. Given the urgent situation, Chelomey revised these plans and decided to use the two-stage version directly for orbital launches. Activities at the M. V.



Vladimir Chelomey (right) next to Academy of Sciences President Mstislav Keldysh
(files of Asif Siddiqi)

95 Ibid p 145 S V Romanova "13 November—70 Years From the Birth of G N Babakin (1914)" (English title) *Iz istorii aviatsii i kosmonavтики* 51 (1984-1985) 62-68 Babakin Banketov and Smorkalov *С N Babakin* p 29

96 Petrakov and Afanasyev. "Proton' Passion "

97 "Interview with Academician A A Dorodnitsyn " p 14 Note that Keldysh had been the one to inform Chelomey in August 1955 of the order to establish OKB 155 See Nina Chugunova "V N Chelomey Highlights of His Biography" (English title) *Ogonek* 4-5 (January 1993) 24-29

Khrunichev Plant in Fili were accelerated in support of this plan, as the "investigation commissions" continued to scour through Chelomey's design bureau in search of things to shut down.⁹⁸ If the four test launches were successful, then Keldysh would have a much better chance of defending the threatened booster.

A success on the first launch was mandatory, and engineers at OKB-52 and its Branch No. 1 were ready to ensure that this goal was achieved. One of the perks of the large amounts of financial support Chelomey received during the 1961-64 period was the ability to test-launch vehicle elements on the ground. Approximately 28,000 model and full-scale tests were conducted during the development of the UR-500: in addition, sixteen full-sized test stands were designed and built to verify the standard systems of the booster both separately and connected together. The design bureau also purchased powerful computers to extensively simulate flight conditions, allowing the elimination of numerous possible problems before actual flights. Between June 1963 and January 1965, Glushko's design bureau fired the first stage's RD-253 engine numerous times in tests that closely simulated actual flight conditions. There had been original plans to launch large scientific satellites into orbit using the three-stage version of the UR-500; these plans were modified and smaller variants of the satellites, designated N-4, were created at the design bureau. Chelomey contracted the Moscow-based Scientific-Research Institute of Automation and Instrument Building, headed by another of Korolev's allies, Chief Designer Pilyugin, to develop a modified control system for the space launcher version."

In the spring of 1965, a flight-ready version of the UR-500 was transported to Tyura-Tam. During the heyday of the Khrushchev years, Chelomey had been allocated a vast area in the so-called "Left Flank" of the test range, about thirty-five kilometers northwest of the original city of Leninsk and thirty kilometers west of Korolev's main pad at site 1. Construction had begun on launch complexes for both the UR-200 and the UR-500 during 1960-62. The "Chelomey area" of Tyura-Tam was the focus of massive levels of construction during the early 1960s. To support operations with the UR-500, engineers had begun the construction of:

- Two launch complexes adjacent to one another (at sites 81 and 200), each with two launch pads 600 meters apart
- A refueling station
- An assembly-testing building for space objects (at site 92A)
- A building for integrating the upper stages
- An assembly-testing building for the complete launch vehicle (at site 92)

A residential zone (at site 95), designed to accommodate 10,000 people, was also in the process of construction at the time." All this was in addition to the pads for the smaller UR-200 ICBM/space launcher; when the UR-200 program was terminated, its support complexes and pads were handed over to Yangel.¹⁰¹

98 V. A. Vyrodov, M. K. Mishetyan, and V. M. Petrakov, "16 July—25 Years From Beginning of Operation of the 'Proton' Rocket-Carrier" (English title), *Iz istorii aviatsii i kosmonavtiki* 64 (1990): 58-67.

99 Dmitry Khrapovitskiy, "Absolutely Unclassified: The Ground Waves of Space Politics" (English title), *Soyuz 15* (April 1990): 15; Petrakov and Alanasyev, "'Proton' Passion": I. Alanasyev, "35 Years for the 'Proton' RN" (English title), *Novosti kosmonavtiki* 1-2 (1998): 45-48.

100 V. Menshikov, "Cosmodromes: Rockets and People: Baykonur" (English title), *Aviatsiya i kosmonavtika* no. 4 (April 1993): 8-9; Jacques Villain, ed., *Baikonour la porte des étoiles* (Paris: Armand Colin, 1994), p. 110.

101 V. L. Menshikov, *Baykonur moya vol i lyubov* (Moscow: MEGUS, 1994), p. 158. A formal decision on transferring the UR-200 pads to Yangel's R-36 ICBM program was issued on August 24, 1965.

Chelomey's engineers prepared a flight-ready two-stage UR-500 booster for flight in July 1965 from site 81 with the N-4 satellite, which was a 12.2-ton (8.3-ton mass in orbit) scientific observatory designed to study cosmic rays and the interaction between high-energy particles and matter. The satellite was manufactured on the basis of the UR-500's third-stage tankage. The haste with which the launch was prepared affected the prelaunch preparations. During fueling operations, a nitrogen tetroxide leak threatened to seriously damage the booster itself; emergency inspections proved that the rocket was safe for liftoff. The UR-500 took off on July 16, 1965, and successfully inserted its payload into a nominal orbit. The unqualified success of the launch signaled the official entry of Chelomey into the "space club" that had been dominated by Korolev and Yangel. The Soviet press made much of the mass of the satellite, far heavier than anything yet orbited by the Soviet Union. Perhaps to affirm the connection with its scientific program, the satellite was named Proton-1. "Proton" was the name later used to refer to the launch vehicle itself in Soviet press reports, although engineers had originally planned to call the rocket *Gerkules* ("Hercules"), a name that was painted on the side of the booster on its first launch. The media releases at the time touted the launch as a new stage in Soviet space exploration. While the performance of the UR-500 booster may have been flawless, the same could not be said of the Proton-1 satellite. Once the satellite was inserted into orbit, ground stations failed to receive any word from the payload. For several orbits, desperate ground controllers at the General Staff of the Ministry of Defense in Moscow attempted to make contact with the satellite, and they finally gave up when they conclusively ascertained that there had been a major failure aboard the craft."

Notwithstanding the failure of the Proton-1 satellite, Chelomey's people carried out three more orbital launches of the UR-500 in 1965 and 1966, of which only one was a complete failure—a good record for a completely new booster." The successful tests of the Proton launcher were pivotal in convincing the Soviet leadership that perhaps this was one of Chelomey's projects best left untouched.¹⁰⁴ It seems that the faith that Keldysh and Chelomey invested in creating this launch vehicle had been well worth it. The Proton rocket would go on to become one of the most dependable and famous launch vehicles ever created by any nation, launching commercial satellites into space and serving well into the 1990s. It was a curious destiny for a missile originally conceived as a super-heavyweight ICBM capable of launching Armageddon-strength megaton warheads at the enemy.

Chelomey had two major piloted space projects under way at his design bureau when Khrushchev was ousted: the Raketoplan reusable hypersonic spacecraft effort and the LK-1 cir-

102 Col (Res) I Zamyshlyayev Supporting Space Flights Signal Suitable for Processing (English title) *Aviatsiya i kosmonavtika* no 11 (November 1990) 44-45 The official TASS announcement for the Proton launch stated "Analysis of the telemetric information received indicates that the apparatus on board the space station Proton 1 is operating normally. The coordination computation center is processing the incoming information." See "Proton 1 in Flight" (English title) *Komsomolskaya pravda* July 17 1965 p 1 Another source suggests that although the controllers did not have initial contact they did establish contact after a few hours. See Afanasyev "35 Years for the Proton" RN

103 The launches were on November 2 1965 March 24 1966 and July 6 1966 The March launch was a failure. The November launch was the first from the second pad at site 81. See Petrakov and Afanasyev "Proton Passion"

104 Ustinov was apparently one of those who was convinced of the need to continue with the program. See Zakharov "Operation Kedr or How the Proton Was Saved" Note that without doubt the most important work at OKB 52 during this period was the UR 100 ICBM project. The program had been formally approved on March 30 1963. Due to strong support from Deputy Minister of Defense A. A. Crechko the program was allowed to continue after Khrushchev's fall. The missile was launched for the first time on April 19 1965 continuing its test launches until October 27 1966. The missile was declared operational in July 1967 after approximately sixty launches. See Zhiltsov ed *Gosudarstvennyy kosmicheskiy* pp 58-60 I. D. Sergeev ed *Khronika osnovnykh sobytiy istorii raketnykh voysk strategicheskogo naznacheniya* (Moscow TsIPK 1994) p 38

cumlunar program. Each suffered the repercussions of the leadership change, but in different ways. The Raketoplan project had stumbled forward through the years despite technical problems related to protecting the spaceplane from the stresses of atmospheric reentry — problems that had destroyed the M-12 spaceplane during its suborbital flight in 1963. Originally intended for piloted circumlunar missions, by May 1964, the Raketoplan had only military goals, such as anti-satellite operations, reconnaissance, and orbital bombing, all from Earth orbit. Chelomey's idea apparently interested powerful forces within the military. On June 18, 1964, USSR Minister of Defense Rodion Ya. Malinovskiy signed the ministry's five-year plan for space-based reconnaissance covering 1964–69. Among the projects included for approval was a spaceplane program designated "R."¹⁰⁵ By this time, Chelomey's engineers, based on their Raketoplan research from 1961 to 1963, had produced the technical designs for a new iteration of the design, comprising two different Raketoplans, the automated R-1 spacecraft, and the piloted R-2 vehicle.

The R-1 was essentially a test model for the piloted version. It would be used for testing all essential systems in Earth orbit, including:

the orientation and stabilization systems, heat shielding, systems for triggering separating components and [also for testing] the dynamics of uncoupling, ballistic and aerodynamic parameters of the Raketoplan and engine [and] the operation of all on-board systems."¹⁰⁶

The R-2, a heavier variant of the spaceplane, was designed to allow "the pilot-cosmonaut [to] check out control-monitoring, communication, and observation functions from space."¹⁰⁷ A nominal orbit for this single-pilot military spaceplane would be 160 by 290 kilometers with a total flight time of twenty-four hours. Maximum acceleration during reentry would be limited to three and a half to four g's. Presumably, both the R-1 and R-2 "boost-glide" vehicles would deorbit in a thermally protected container that would be discarded after atmospheric reentry, deploy wings, turn on a turbojet engine, and then land on a conventional runway. Either Korolev's R-7 or the UR-500 would serve as the launch vehicle for the R-1 and R-2 spaceplanes.

The primary goal of the R-2 spaceplane project was photo-reconnaissance and/or anti-satellite operations, and both were objectives that were vigorously supported by the Soviet Air Force in its quest to get a piece of the Soviet piloted space program. Marshal Vershinin, the Commander-in-Chief of the Air Force, publicly spoke of the Raketoplan effort in August 1964, saying that spaceplanes were not only feasible, but that Soviet engineers were engaged in a development program that was "not without success."¹⁰⁸ By 1964, OKB-52 engineers had evidently completed the design of the R-2 boost-glide vehicle "at the Air Force's request."¹⁰⁹ They had already begun the construction of flight models when Khrushchev's ouster threw the program into jeopardy, leading to the "temporary suspension" of work sometime in 1965 or 1966.

There continues to be conflicting information on why the project was closed down at the time. Some suggest that it was related directly to the post-Khrushchev vendetta against Chelomey. One engineer recalls that the termination order came from "upstairs" at a time when

105 Kamanin *Skrytiy kosmos 1964–1966* p 58

106 Anatoliy Kirpil and Olga Okara "Designer of Space Planes Vladimir Chelomey Dreamed of Creating a Space Fleet of Rocket Planes" (English title), *Nezavisimaya gazeta* July 5, 1994 p 6

107 *Ibid*

108 "Soviets Developing Spaceplane" *Space Business Daily* August 18 1964 p 1

109 I B Afanasyev "Unknown Spacecraft (From the History of the Soviet Space Program)" (English title) *Nouoye v zhizni Nauke tekhnike Seriya kosmonautika astronomiya* no 12 (December 1991) 1–64

the most formidable technical problems had already been solved.¹¹⁰ Five days after Khrushchev's fall, on October 19, 1964, Marshal Vershinin apparently telephoned to inform Chelomey that all materials related to the Raketoplan project would be turned over to another design bureau. By this point, OKB-52 had already finished the construction of a "life-size" model of the R-2 spaceplane with a functioning cabin for one cosmonaut. Despite the order, by March 1965, Chelomey had finished the final draft plan for the R-1/R-2 models. He apparently met with Brezhnev himself on August 3, 1965, to persuade him to sign an agreement with the Navy to develop a piloted Raketoplan, but nothing seems to have come out of the meeting.

There is a second version to the story that suggests that the work on the Raketoplan was terminated at the time because of internal reasons. Sergey N. Khrushchev suggests that "Chelomey understood that it would be impossible to enter the atmosphere with wings with that time's technology," prompting him to put the idea on hold." A senior designer at OKB-52, Gerbert A. Yefremov, who would go on to succeed Chelomey, also recalled in an interview: "Termination (not prohibition from above) of the rocket-plane program in the first half of the 1960s was induced by [the] reorientation of [OKB-52] towards developing [the] LK-1 one-man space vehicle for a flight around the Moon."¹¹¹

The most likely scenario is that Chelomey opted to temporarily suspend the program around 1965 because of both technical and political difficulties. The Air Force, still itching for a spaceplane of its own, ordered OKB-52's research database transferred to another organization. If Chelomey would not do it, then they would have someone else do it. This someone else turned out to be General Designer Artem I. Mikoyan, head of OKB-155 and the developer of the famous MiG jet fighter aircraft. In 1965, a number of Chelomey's best designers on the Raketoplan program left his design bureau, taking with them the results of their research to join Mikoyan's organization.¹¹² It was a strange irony. In 1953, when Stalin had closed down Chelomey's original design bureau, much of his research work had also been transferred to Mikoyan. The move to Mikoyan in 1965 was the end, at least temporarily, of Chelomey's persistent quest to fly a spaceplane into orbit. At the same time, it was the beginning of yet another Soviet spaceplane project, one named Spiral, which would continue on for more than a decade.

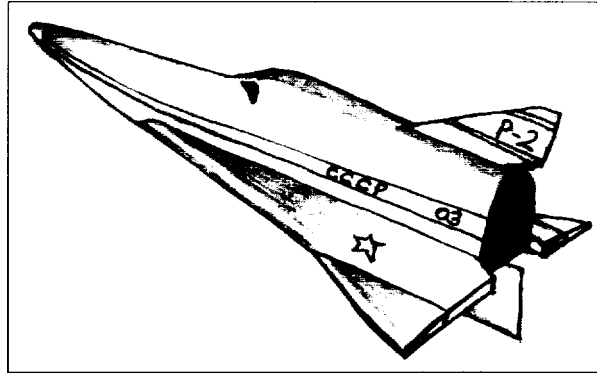

This is a drawing of the R-2 piloted spaceplane as it emerged during 1964-65 at the Chelomey design bureau. The program was suspended at the time, because of a combination of technical and political factors (copyright Asif Siddiqi)

¹¹⁰ Mikhail Rudenko "Space Bulletin Lunar Attraction Historical Chronicles" (English title), *Vozdushniy transport* 24 (1993) 11

¹¹¹ Khrushchev interview October 10, 1996

¹¹² Interview Gerbert Aleksandrovich Yefremov with the author March 3 1997

¹¹³ Kirpil and Okara "Designer of Space Planes"

The LK-I Circumlunar Program

If, as OKB-52 designer Yefremov claimed, the Raketoplan project was suspended to focus resources on the LK-I circumlunar project, then there was good reason to do so. When the UR-500/LK-I project had been approved in August 1964, it was Chelomey's first solid entry into the piloted space program. Based on the design of the return capsule of NASA's Gemini spacecraft, the LK-I spacecraft was to carry a single cosmonaut around the Moon by the second quarter of 1967—that is, before the fiftieth anniversary of the Russian Revolution. With a mandate like that, it was probably best to focus the limited resources on the most fruitful projects. This program to send humans around the Moon was curiously one of Chelomey's projects that survived the scrutiny of the days following Khrushchev's fall. The "investigation commissions" probably carried out some level of assessment of the project in late 1964, and it seems that they voted in favor of continuing work on the program.

This was in spite of the fact that Korolev possibly took advantage of the anti-Chelomey sentiment in the government to mount a vigorous attack on Chelomey's circumlunar project in the waning days of the year. This time, perhaps under pressure from his deputies, Korolev abandoned the highly unwieldy multiple-docking mission profile for the 7K-9K-11K Soyuz complex. Instead, he offered up the N11 booster, which would launch a twenty-ton spacecraft into Earth orbit. The payload, comprising a translunar-injection (TLI) stage and a Soyuz spacecraft, would then head for the Moon, carrying out a simple circumlunar flight.¹¹⁴ For reasons that are unclear, the Soviet government was not interested at the time, perhaps unwilling to abruptly change directions in a program whose key determinant of success was doing it before the Americans. An unconfirmed source states that the Military-Industrial Commission signed a decree on October 28, 1964, essentially confirming Khrushchev's old plan of dividing up the piloted lunar program: Chelomey retained the circumlunar portion and Korolev retained the landing.¹¹⁵

Chelomey signed off on the "experimental design" of the LK-I ship on August 3, 1964, the same day that the government passed the decree committing to the piloted lunar program.¹¹⁶ Unlike Korolev, whose proposed 7K-9K-11K circumlunar effort would use a multitude of different spacecraft linking up in orbit, Chelomey completely bypassed the idea of Earth-orbit rendezvous as an element of *his* plan. His UR-500 booster was, after all, far more powerful than any booster in Korolev's canon. Originally, Chelomey's engineers conceived of a spaceship launched on the two-stage UR-500 booster, which would allow a payload of roughly twelve tons to be inserted into Earth orbit. This, however, proved to be inadequate to comprise a TLI stage as well as the spacecraft proper. Within a few months, boosters were switched in the circumlunar project; engineers opted to use a three-stage version of the UR-500, designated the UR-500K. More payload capacity was added by increasing the length of second-stage tankage and introducing slightly modified engines. The new third stage was essentially a shortened version of the second stage. This would allow a payload of almost eighteen tons to be inserted into Earth orbit, sufficient for a piloted spacecraft and its TLI stage. On November 11, 1964, Chelomey outlined the program of launches for the UR-500K and its lunar LK-I payload.¹¹⁷

114. V. P. Mishin, "Why Didn't We Fly to the Moon?" (English title). *Znaniye tekhnike serya kosmonavtika, astronomiya* no. 12 (December 1990): 3–43.

115. Rudenko, "Space Bulletin: Lunar Attraction "

116. Afanasyev, "Unknown Spacecraft "

117. Igor Afanasyev, "Without the Stamp 'Secret': Circling Around the Moon: Chelomey's Project" (English title). *Krasnaya zvezda* October 28, 1995, Afanasyev. "35 Years for the 'Proton' RN " A conception of the original two-stage variant is shown in I. A. Marinin and S. Kh. Shamsutdinov, "Soviet Programs for Lunar Flights" (English title). *Zemlya i vselennaya* no. 4 (July–August 1993): 62–69. The new engines for the UR-500K second stage were the RD-0210 and the RD-0211. The third stage used the RD-0212, which consisted of the RD-0213 and the RD-0214.

The payload of the UR-500K would consist of the following four sections, each for a different part of the mission:

- Blok A—the TLI stage
- Blok B—the instrument-aggregate compartment or service module
- Blok V—the return apparatus, which would carry the crew
- Blok G—the launch escape system"

Blok A was powered by the R6-117 liquid-propellant rocket engine with a thrust of thirteen and a half tons in vacuum." The propellants were the same as the UR-500K booster itself: unsymmetrical dimethyl hydrazine and nitrogen tetroxide. The development of the R6-117 engine was a first for OKB-52: not only did the organization have minimal experience in the design of rocket engines, it had never designed one for operation in vacuum. In comparison, Korolev's OKB-1, with years of experience, was facing severe problems during the same period with its own upper stage engine for the N1 and other boosters.

Bloks B and V comprised the LK-1 spacecraft itself. Blok B, similar to the Apollo Service Module, was a cylindrical compartment carrying power sources, electronic instrumentation, engines for mid-course corrections and attitude control, and propellant tanks. Soon after TLI and separation of Blok A, the spacecraft would unfurl a set of two solar panels to provide power during the remaining portion of the mission. Total wingspan was on the order of about seven meters. The panels were not attached to the side of the cylinder, but rather to pylons extending rearwards from the base of Blok B. OKB-52 also studied the possibility of using fuel cells working on hydrogen and oxygen in the spacecraft, but it is not clear whether this was adopted for the final design. A small high-gain antenna was located at the base of the module for communications. Blok V was a simple cone, similar to the Apollo Command Module, which was installed on the forward end of the cylindrical "service module." The single cosmonaut would spend the entire mission in here. Attitude control engines were installed on the exterior for motion control prior to reentry, while the internal space carried a single couch, scientific apparatus, communications systems, life support systems, and TV and still cameras for both live broadcast and stored film. The conical shape would allow the vehicle to use a better lift-drag ratio for a controlled reentry into Earth's atmosphere following the return from the Moon."

Finishing up the payload was Blok G, which was the launch escape tower. It was the first such system installed on a Soviet piloted spacecraft and was powered by solid-propellant engines capable of taking the Blok V capsule far away from a malfunctioning launch vehicle. The complete LK-1 spacecraft was remarkably small for a piloted vehicle earmarked for flight to the Moon. Although spacecraft masses have still not been revealed, one Russian space historian with access to design bureau documentation has stated that:

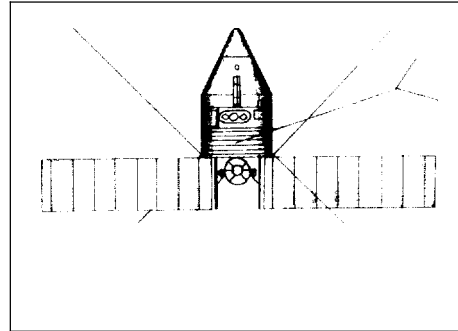

Chelomey's LK-1 spacecraft was designed in 1964-65 for a circumlunar mission. The ship would be launched by a three-stage Proton booster augmented by the special Blok A translunar-injection stage (copyright Asif Siddiqi)

118 Afanasyev. "Without the Stamp 'Secret'."

119. Yefremov interview, March 3, 1997

120 Afanasyev. "Without the Stamp 'Secret'". Afanasyev. "Unknown Spacecraft"; Marinin and Shamsutdinov. "Soviet Programs for Lunar Flights."

noteworthy in the *LK-1* design was the rather small mass and size of the return apparatus. Gradually optimizing the characteristics of the systems of the spacecraft and the launcher, the designers managed to *increase* the return apparatus' mass and make room for another [second] cosmonaut.¹²¹

The base diameter of the conical return apparatus was on the order of two and three-quarters meters, and mass of the entire *LK-1* spacecraft was probably limited to about four tons. The return apparatus weighed approximately two tons, lighter than even the *Vostok* crew capsule.

Engineers at OKB-52 designed the UR-500K/*LK-1* complex with very little margin for error. The very low mass of the spacecraft indicates that many systems were probably not backed up, even though the dangers of instrument failure were much greater for a circumlunar mission than for a simple Earth-orbital flight. The primary constraint on the whole mission was clearly the lifting power of the UR-500K and its capacity to insert into Earth orbit a fully fueled TLI stage plus a crewed spacecraft. Thus, the success of a mission would have to depend on the perfectly nominal performance of the UR-500K and the "booster unit," both working at the limits of their design levels. Perhaps to compensate, Chelomey planned a long and extensive flight program for the project. This plan, finalized in late September 1964, called for twelve consecutive launches during 1965 through 1967 using both the two-stage UR-500 and the three-stage UR-500K.¹²²

Work on the project was uneven. This was the first serious attempt by Chelomey to develop life support systems, heat shields, high-thrust rocket engines, highly complex avionics, and spacesuits; there is no evidence to suggest that there was any osmosis of information on these topics from the Korolev organization to the Chelomey design bureau. Chelomey simply had to start from scratch. The draft plan for the *LK-1* spacecraft was finished by July 1965, coincidentally during the same month that the UR-500 Proton booster was launched on its first flight.¹²³ The plan apparently "fully fulfilled the requirements" of the original conception of the circumlunar mission.¹²⁴

For Chelomey, his whole claim to the cosmos depended on the UR-500K/*LK-1* piloted circumlunar program. The immediate post-Khrushchev era was a time of great difficulty for the ambitious general designer and his organization. Two of his most coveted instruments for entering the Soviet space program, the UR-200 launch vehicle and the Raketoplan program, had been canceled or suspended. Thus, after almost five years as the reigning designer in the Soviet space program, he had little to show in terms of concrete achievements. A number of Soviet historians have argued that this period—1961 to 1964—when Chelomey was bestowed unlimited funds, was a gross miscalculation on the part of the Soviet leadership, for it primarily deprived Korolev of support to successfully carry out his own programs. The NI had almost died a slow death because of a lack of money, while the 7K-9K-1 IK Soyuz program had been the subject of innumerable delays. Korolev had been forced to resort to one-off "spectaculars" such as the *Voskhod* mission in 1964 to maintain his apparent eminence in the space program. Georgiy S. Vetrov, a historian at Korolev's design bureau, has argued:

121 Afanasyev. "Unknown Spacecraft "

122 L. N. Kamanin, "In the Future His Name Will Probably Be ..." (English title), *Ogonek* 7 (February 9–16 1991), 28–31; Rudenko, "Space Bulletin: Lunar Attraction." Note that in the latter source, the author states that there would be two sets of twelve launches in the entire program.

123. Yefremov interview, March 3, 1997. More specifically, Dr. Yefremov stated that the "conceptual design" of the *LK-1* was finalized at the time

124. Afanasyev. "Without the Stamp 'Secret'."

*The situation with the creation of V. N. Chelomey's OKB was only one example of the wasting of forces and resources which proved to be disastrous for the realization of [our] space program. The organizational context giving exclusive rights to the leading designer was good at the beginning, but eventually proved to be negative. The Chief Designers, feeding on their power and authority, started ruling without consulting anybody and their orders entirely determined the direction of the work.*¹²⁵

Vetrov's claim has some basis in reality. Because the institutional makings of the Soviet piloted space program were steeped so deeply amid the ballistic missile effort, the chief designers had to resort to personal machinations to sustain programs. Both Chelomey and Korolev were thus put in the position of steering space policy. Because Chelomey happened to be the favored designer during this period, his ideas and proposals benefited, to the detriment of Korolev. It would be difficult and, in fact, pointless to speculate what would have happened had the tables been turned. Georgiy N. Pashkov, the influential deputy chairman of the Military-Industrial Commission said many years later that favoring Chelomey wasted a full five years of the Soviet space program.¹²⁶ Chelomey's people, of course, had other opinions. Perhaps referring to the anti-Chelomey sentiment following Khrushchev's fall, Chelomey's deputy Yefremov recalled:

*When you look back, you're surprised at how often, at the top, unsound decisions were made which delayed for many years the realization of some of the space developments of our collective or completely stopped developments. There's no doubt that had to do with the subjectivity and incompetence of certain leaders. Our "evil genius" turned out to be the Deputy Chairman of the Military-Industrial Commission G. N. Pashkov.*¹²⁷

Each side had their own views, and unable to redress their grievances in the press, they kept their complaints to themselves, bottled up for more than a quarter of a century. Such was the real tapestry of the early Soviet space program, hidden behind the glories of Vostok and Voskhod.

A Walk in Space

The Voskhod mission in October 1964 claimed more glories for the Soviets. While most of the Western press were understandably more interested in the change in leadership at the Kremlin, the general reaction in the West to the Voskhod flight was unprecedented. In the eyes of most people, the Soviet Union had again achieved another important milestone in the space race while the United States was still attempting to catch up. With little concrete information on which to depend, the media were awash with speculation, and as always, the Soviets did little to fill the black hole of information. There were no descriptions of the spacecraft, no indication that it was merely a modified Vostok, and no hint of its extremely limited capabilities. Many in the West simply believed that the Voskhod was a Soviet spacecraft comparable to NASA's Apollo vehicle, which was still on the drawing board.²⁸ At a press conference on October 21 following the Voskhod mission, Academy of Sciences President Keldysh added to

125 G. Vetrov 'The Difficult Fate of the NI Rocket' (English title) *Nauka i zhizn* no 5 (May 1994) 20-28

126 Lardier *L'Astronautique Soviétique* p 153

127 Khrapovitskiy "Absolutely Unclassified" p 15

128 On October 14 a journalist from The Washington Post Howard Simon reported that the Soviet Union was building a 'giant new rocket which could be capable of taking Russian cosmonauts to the Moon. He added that the Soviets were preparing "to run the Moon race fast and hard" notwithstanding recent statements suggesting the opposite." See *Soviet Space Programs 1962-65* pp 386-87

the myth of the Soviet space program by stating: "In the Soviet Union purposeful and systematic work goes on in connection with manned space flights. This is not for effect, but in the interests of progress."¹²⁹ Such a claim was especially galling in the light of this particular flight, which had no other purpose than to upstage Gemini. Within OKB-1 itself, sentiments may have been different. Korolev's First Deputy Mishin recalled twenty-five years later: "The [Voskhod] program made no contribution whatsoever to the further development of space research. It was simply a waste of time. Sending three people into space together was done purely for prestige."¹³⁰

The original decrees in March and April 1964 in support of Voskhod had specified five launches, two of which would be piloted; the first was scheduled for August and the second for November. Specific mission goals for the second mission were formulated from the hodgepodge of Air Force and OKB-1 proposals for "extended Vostok" missions over the previous two years. From about March 1964, it was clear to Korolev that the second Voskhod mission would include a "spacewalk" by one of the crewmembers.¹³¹ These plans seem to have partly stemmed from earlier Air Force and OKB-1 suggestions to conduct extravehicular activity (EVA) with a dog on one of the later Vostok missions. Certainly, most of the motivations were external—that is, NASA's publicly announced plans to carry out EVA during the Gemini program. Once again, it was unacceptable for Korolev to lose the edge over the Americans. In fact, during early planning, Air Force General Staff Deputy Lt. General Kamanin had proposed sending a single cosmonaut into orbit as a test of the EVA-equipped ship. Korolev outright rejected this approach:

He was troubled not by technical considerations, but by purely political considerations—a one day test flight with one cosmonaut would not represent a new triumph in space. In the opinion of many, each manned spaceflight should be a new, major advance.¹³²

Korolev called the EVA project *Vykhod* ("Exit"), a term originally used in 1963 studies at OKB-1 to describe spacewalks.

The delays in the first Voskhod mission obviously pushed the *Vykhod* mission beyond the original November deadline, but it seems that Korolev had been insistent that the flight be carried out prior to the end of the year. In a diary entry from early September 1964, Kamanin wrote:

*... Korolev is pestering all his associates, and assuring them that before the year is out, he will launch the *Vykhod*—a modification of the *Voskhod* adapted for an EVA by a cosmonaut. As always, Korolev is in a hurry: He prefers a cavalry charge to well-conceived and methodically prepared offensives on the "space fortress...."*

One of the reasons for Korolev's haste may have been political: he had apparently made a promise to Khrushchev that he would launch the *Vykhod* in November in time for the anniversary of the Great October Revolution. With Khrushchev out of power, the deadline no longer seemed as important, and by the time that the three Voskhod cosmonauts landed in October, the *Vykhod* mission was tentatively planned for early 1965.

¹²⁹ lbtd p 554

¹³⁰ "The Russian Right Stuff" NOVA television show

¹³¹ The cosmonauts' training for the "spacewalk" mission began training in April 1964. See Peter Smolders, *Soviets in Space* (New York: Taplinger Publishing Co., 1973) p. 139.

¹³² L. N. Kamanin, "Pages From a Diary: He Soared Freely Above the Earth On the 25th Anniversary of the Flight of Pilot Cosmonauts P. I. Belyayev and A. A. Leonov in the Voskhod 2 and the First Spacewalk" (English title) *Sovetskaya Rossiya*, March 17, 1990, p. 6.

¹³³ Kamanin, "I Would Never Have Believed Anyone" p. 4.

The goal for engineers was of a similar scale to the first Voskhod: to modify a Vostok spacecraft in such a manner as to carry a crew of two cosmonauts, of whom one would conduct a spacewalk. The Vykhod team was headed by OKB-1 Deputy Chief Designer Pavel V. Tsybin, a veteran of a number of aerospace projects, including the infamous PKA piloted spaceplane, which was abandoned in the late 1950s. Tsybin's team never seriously considered the Gemini approach of depressurizing the entire spaceship during an EVA, evidently because of the less-than-stellar performance characteristics of the life support system. In addition, even if the spacecraft could be depressurized, the internal instrumentation in the ship would not function, because it had not been designed for operation in vacuum. Instead, Tsybin's engineers drew up a plan for the design and installation of an airlock on the side of the basic vehicle. Both cosmonauts would wear fully operational pressure suits throughout the mission. One of the three Elbrus couches from the three-person Voskhod vehicle was eliminated, allowing fully suited cosmonauts to fit into the small internal volume of the ship. Prior to the spacewalk, the pilot would crawl into the airlock, shut the hatch behind him, pressurize the airlock, open an outer hatch, and then step out into space. Given the limited mass and volume capabilities of the IIA57 launch vehicle, a large rigid airlock was out of the question. Consequently, an engineer at OKB-1, S. I. Aleksandrov, proposed the use of an inflatable cylindrical airlock—one that could be packed at launch on the ship's hatch and then unfurled to full length in flight. Korolev signed the draft plan for the "new" spaceship, designated product 3KD, sometime in late 1964.¹³⁴

The principal modifications to the 3KD as compared with the 3KV were the installation of:

- The Volga airlock on hatch no. 3 on the descent apparatus
 - Two Elbrus couches modified for spacesuited cosmonauts
 - Air conditioning and life support systems for the cosmonauts' spacesuits
 - An autonomous life support system in a backpack for the EVA cosmonaut
 - An emergency oxygen-ventilation system for the cosmonauts during landing in case the spacecraft life support failed
- Automatic systems for the operation of the airlock, spacesuit life support, and the two hatches
- Special valves for equalizing pressure between the airlock and the descent apparatus capable of being operated both automatically and manually
- A control panel for manually operating the airlock and hatches
 - Supplementary bottles of air for both the EVA spacesuit and the descent apparatus, which would be installed on the exterior of the Instrument compartment">

In all other respects, the Vykhod was exactly like the first Voskhod. The mass of the "new" vehicle was approximately 5,685 kilograms. A nominal mission would last a single day.

Plant No. 918 located at Tomilino built the Volga airlock, although OKB-1 engineers designed it. This was the same organization that had designed the SK-1 suits and ejection seats for the earlier Vostok spacecraft. In January 1964, thirty-seven-year-old Gay I. Severin, an aeronautical engineer and former glider pilot, was appointed chief designer and director of the plant. More than any other individual, Severin was personally responsible for the design of the Volga as well as the EVA suit. When work on the project began in June 1964, Korolev told his senior

¹³⁴ This document has been published with disguised designations as S. P. Korolev "The Voskhod 2 Space Ship" (English title) in Keldysh ed. *Tuorcheskoye naslediyе Akademika* pp. 477-88

¹³⁵ *Ibid*

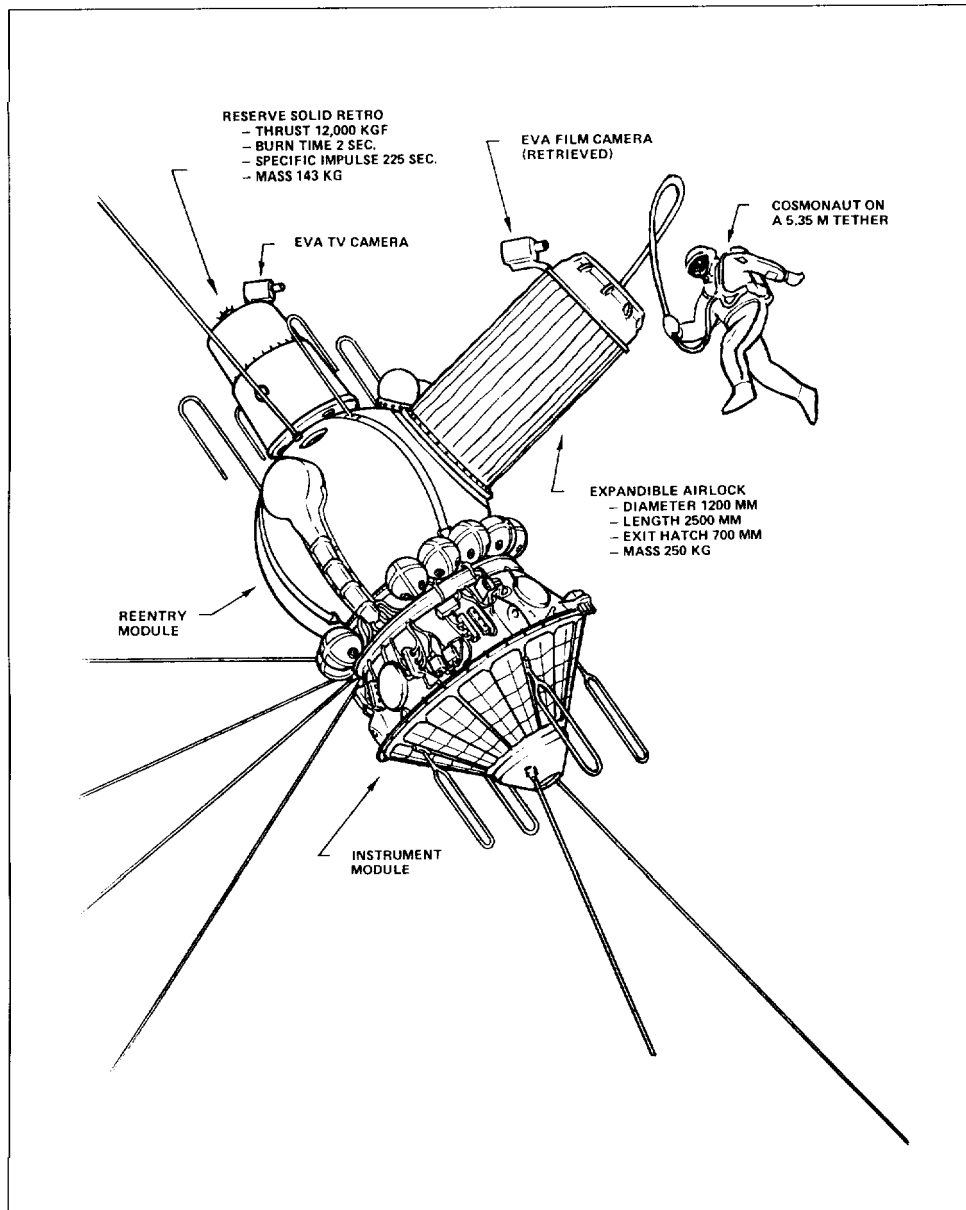

This diagram shows the EVA-equipped Voskhod spacecraft. (copyright D R Woods)

designer responsible for the Vykhod. "From now on there is another commander aside from me at our enterprise, and that's Severin. You should carry out his orders faster than mine.""

Severin's airlock was an ingenious creation. In a packed state, the Volga had a length of seven-tenths meter, extending to two and a half meters in its operational position. Each end of the

136 "To Save Man A Conversation With the General Designer of Life-Support and Rescue Systems Hero of Socialist Labor G I Severin" (English title) *Pravda* June 26. 1989 p 4

cylinder was terminated by a rigid ring with a hatch with an external diameter of 1.2 meters. The internal diameter was one meter, while the diameter of the hatchway was only 0.65 meter, an extremely tight fit for a completely suited cosmonaut with a backpack. The complete airlock system had a mass of 250 kilograms. In typical Soviet fashion, the equipment was a sturdy technological marvel. An engineer recalls the first time Korolev visited Plant No. 918 to see the airlock:

"Gay llich [Severin]." Sergey Pavlovich addressed the director of the enterprise where various aggregates for the spacecraft were being developed, "demonstrate to us the durability of your airlock chamber." Gay llich, a tall, stately, athletic looking man who was still young, easily jumped up and hung on one end of the cylinder. . . . Sergey Pavlouich smiled coyly. He was happy with the technical design.¹³⁷

The airlock itself was made of a double-walled pressurized material made from rubber. The space between the layers was divided along its longitudinal axis into forty full-length partitions, which would be pressurized to extend the airlock to its full length, not unlike an inflatable water raft. The partitions were divided into three independent sections: two were enough to ensure that the airlock would unfurl to its operational state. An extra layer of thermal insulation covered the entire airlock. Four tanks at the base of the Volga carried pressurized air. One each were for the forty partitions and to pressurize the airlock after the EVA (which would take seven minutes), while the remaining two were emergency supply for the spacewalking cosmonaut. There were four cameras placed at various points to record the egress of the EVA pilot. Two sixteen-millimeter movie cameras were installed within the airlock, and a third sixteen-millimeter camera was on a boom outward from the airlock to record the spacewalk. A fourth TV camera, a Topaz developed by Leningrad-based NII-380, would provide live pictures to both ground control and the crew commander (the cosmonaut who would remain behind in the spaceship). Engineers designed the entire system such that the commander could carry each operation out both automatically or by manual control. In addition, there was a small control panel installed within the airlock itself to allow the EVA cosmonaut to control hatch openings, and so forth, in the case of an emergency.¹³⁸

The *Berkut* ("Golden Eagle") spacesuit, also designed under Severin's leadership, was the first Soviet spacesuit created for EVA operations. It consisted of two primary "pressurized membranes" that allowed minimal mobility in an airtight state. There were two settings for pressure, one at 0.35 to 0.4 atmosphere (normal) and one at 0.2 to 0.27 atmosphere (for increased mobility during emergencies). The helmet had two pressurized visors and a filter for the Sun's rays. The *Berkut* also included a self-contained backpack, which contained a ventilation system as well as three two-liter tanks at 220 atmospheres pressure. Air was pumped into the helmet at a rate of twenty liters per minute from where it passed to the rest of the suit through a pressure regulator. A five-meter cord would connect the cosmonaut to the ship during the EVA. The total mass of the suit and backpack was forty-five kilograms (twenty plus twenty-five kilograms, respectively). The maximum time in an "open" exposed state would be limited to only ten to fifteen minutes during the mission. The self-contained backpack was designed to provide life support for a maximum of forty-five minutes, while the emergency tank on the outside of the airlock could provide eighty additional minutes of air. OKB-1 and Plant No. 918, how-

¹³⁷ A. Yu. Ishlinskiy, ed., *Akadernrk S P Korolev ucheniy. inzhener, chelovek* (Moscow: Nauka, 1986), pp. 421-22.

¹³⁸ Korolev, "The 'Voskhod-2' Space Ship"; Dietrich Haeseler, "Leonov's Way to Space: Airlock of Voskhod-2," *Spaceflight* 36 (August 1994) 280-82. The Topaz used a 625-line, twenty-five-frames-per-second system

ever, formulated mission plans to be as conservative as possible. A nominal EVA would last only ten to fifteen minutes, sufficient to achieve the main objective of the flight.”

In late 1964, Korolev and his engineers drew up a detailed test program leading to the actual EVA mission. The five-step program included testing the 3KD at plants, training and testing in conditions approximating microgravity in a Tu-104 aircraft, vacuum testing in the TDK-60 barometric chamber, the launch of an automated version of the 3KD into orbit, and finally the piloted flight. The first simulator for the Vychod spacecraft, the TDK-3TD, arrived at the Cosmonaut Training Center in November 1964.¹⁴⁰ Four of the remaining 1960 batch of cosmonauts who had yet to fly a mission—Belyayev, Khrunov, Leonov, and Gorbatko—were grouped together by July 1964 to begin training for the challenging mission. Belyayev and Gorbatko trained for the commander's seat, while Khrunov and Leonov prepared themselves for the EVA position.

From the beginning, the training for the Vychod mission was without doubt the most demanding of all the Soviet piloted flights to date. As part of a general calisthenics regimen, Leonov, the informal favorite to carry out the spacewalk, cycled about a thousand kilometers in less than a year, carried out more than 150 EVA training sessions, and jumped by parachute 117 times. Weightlessness simulations were carried out in a specially equipped Tu-104 aircraft, which flew parabolic arcs to simulate microgravity for about thirty seconds at a time. A complete replica of the 3KD spacecraft was installed in the airplane for the cosmonauts to rehearse each aspect of the EVA, including rigorous operation of the airlock. Vacuum tests with full spacesuit garb were also conducted in the ground-based TBK-60 barometric chamber, which simulated high-altitude pressure and atmospheric conditions. The cosmonauts were “launched” to altitudes of five, ten, and thirty-two to thirty-six kilometers to carry out their flight program. In addition, physicians were evidently unsure of the possible psychological state of a spacewalking cosmonaut and subjected Leonov to a month-long isolation chamber test when he was completely cut off from the rest of the world. Immediately after the end of his session, he was taken directly to a MiG-15, whose pilot performed several complicated flight maneuvers. The flight ended with Leonov ejecting out and landing safely by parachute as a test of his reflexes after an extended period of isolation.¹⁴¹

The State Commission for the flight, by then renamed Voskhod 2, met for the first time on January 13, 1965, under the chairmanship of Maj. General Tyulin. Engineers reported that two Voskhod vehicles and their associated launch vehicles were essentially ready for launch. Final testing would be completed on February 15. The launch of the robot variant was set for late January or early February, while the crewed mission was set for March.¹⁴² By this point, the best candidates for the primary crew were Belyayev and Leonov. The thirty-nine-year-old Pavel Belyayev had been the oldest candidate selected among the “Gagarin group” of 1960. He had graduated from the Yeisk Higher Air Force School in 1945 and flew combat missions against the Japanese during the final days of World War II. Later, in 1959, he graduated from the famous Red Banner Air Force Academy, and thus he was only one of two cosmonauts in the 1960 class who had a higher education. Belyayev might have flown earlier into space had it not been for a severe ankle injury sustained in August 1961 during a parachute jump, which left

139. Korolev. “The ‘Voskhod-2’ Space Ship”; *Russian Space History*, Sale 6516 (New York: Sotheby's, 1993), description for Lot 40.

140. Lardier. *L'Astronautique Soviétique*, p. 143

141. Ibid. Riabchikov, *Russians in Space*, pp. 212–18; Smolders. *Soviets in Space*, pp. 139–40; I. T. Akulinichev, et al., “Some Results of Medical Supervision of the State of the Cosmonauts P. I. Belyayev and A. A. Leonov During Their Training and Orbital Flight” (English title), *Kosmicheskiye issledovaniya* 4 (March–April 1966): 311–19; Colovanov. Korolev, p. 747

142. Kamanin. “Pages From a Diary”

him out of the loop for a whole year. His co-pilot on the flight was thirty-year-old Aleksey Leonov, one of the most colorful characters on the team. Born in Siberia, he graduated from the Chuguyev Higher Air Force School in the Ukraine in 1957 before serving as a jet pilot in East Germany. Certainly one of the most well-trained candidates on the team, he also had a passion for painting. The future author of many art books, in the early 1960s, he was the editor of a satiric cosmonaut newsletter called Neptun ("Neptune"). Leonov also had the distinction of being the first person whose name was uttered in space, during his shift as capcom for Gagarin's historic flight.¹⁴³

Belyayev and Leonov, along with their backups Zaykin (who had replaced Corbatko) and Khrunov, continued to train intensively for the mission throughout February, carrying out runs in both the Tu-104 and the TKB-60. By February 19, the State Commission had decided on a specific timetable for the two missions: the automated one would be launched on February 21 or 22, while the piloted flight was set for March 4 or 5. In addition to these two missions, three small satellites in the Kosmos series were set aside for launch prior to the piloted launch to ensure that radiation levels were safe for an EVA. The orbital parameters of Voskhod 2 were intended to be 180 by 500 kilometers, far higher than any previous piloted flight. The EVA itself would be carried out immediately after orbital insertion, at the end of the first orbit or at the beginning of the second one. In the case of abnormalities in the spaceship, the crew could elect to carry out the spacewalk on any orbit from the second to the sixth, ensuring that the vehicle would be over Soviet territory during the critical event.¹⁴⁴

Throughout the preparations for the EVA mission, engineers were acutely conscious of yet another race with the United States. By February, the race began to have deleterious effects on the 3KD program. Chief Designer Severin recalled that "the Americans planned to do their EVA in three months and had announced it beforehand. So we felt very rushed. We were hurrying and were nervous. . . ."¹⁴⁵ In this climate, the first 3KD spacecraft was launched successfully into orbit at 1030 hours Moscow Time on February 22, 1965. Initial orbital parameters were 175 by 512 kilometers at a 64.77-degree inclination to the equator. As was usual, the Soviet press did not attribute the satellite any particular mission, merely naming it Kosmos-57. The fully equipped spacecraft was to simulate all the necessary airlock operations: checking the airlock, inflating the airlock, transferring air from the descent apparatus to the airlock depressurization of the airlock, turning on the air supply from oxygen bottles to a spacesuit, opening and closing the outer hatch, repressurizing the airlock, and finally ejecting the airlock assembly on the sixteenth orbit.¹⁴⁶ Despite Lt. General Kamanin's reservation that "we were most doubtful that the airlock would function reliably," all the preliminary operations, save for the ejection, were carried out without anomalies. Satisfied that the mission was going smoothly, Kamanin left the control center in Moscow. When he returned about five hours after launch, he greeted Korolev with "Good evening!" Korolev dryly replied, "No, Nikolay Petrovich, the evening, it seems, is not good. It looks like the craft has blown up. . . ."¹⁴⁷

Kosmos-57 had evidently exploded into approximately 180 pieces. A cursory inspection by engineers revealed that for unknown reasons, the reentry cycle of the satellite had been spuri-

143 Rex Hall "Soviet Air Force Cosmonauts" in Michael Cassutt ed. *Whos Who in Space The International Space Year Edition* (New York: Macmillan, 1992) pp. 219-20, 246-47; William Shelton, *Soviet Space Exploration: The First Decade* (New York: Washington Square Press, 1968) pp. 173-74.

144 Note that in the original document describing the 3KD mission, a nominal orbit is listed as 180 by 400 kilometers. Evidently, sometime between the issuance of that document and February 1965, the State Commission elected to raise the intended apogee to 500 kilometers. See also Kamanin, "Pages From a Diary."

145 "To Save Man: A Conversation With the General Designer."

146 Korolev, "The Voskhod 2 Space Ship."

147 Kamanin, "Pages From a Diary."

ously activated. The retrorocket engine had been fired, but being in the wrong attitude, the satellite had entered an incorrect orbit after engine cutoff. As per programming, the spacecraft's automatic self-destruct system had activated upon entering the incorrect orbit. The cause for the command to reenter remained a mystery until further examination of telemetry. On February 25, Chief Designer Armen S. Mnatsakanyan of NII-648, responsible for telemetry instrumentation, and Colonel Amos A. Bolshoy, the head of the Chief Operations and Control Group for the Voskhod missions, presented reports on the analysis of the data. The findings pointed to ground control error. As per original planning, the controller at one of the ground stations, Measurement Point No. 6 (IP-6) at Yelizovo in Kamchatka, sent a message, command no. 42, to transfer air to the airlock. By an amazing coincidence and contrary to orders, a controller at the backup station, IP-7 at Klyuchi in Ussuriysk, sent the same coded command at the exact same moment. The two commands were received simultaneously, thus becoming a new command, no. 5—that is, the command to descend." Thus the spacecraft was exonerated of any fault.

The Kosmos-57 spacecraft had accomplished most, but not all, of the tasks necessary to instill faith in a piloted mission. Because the robotic precursor had exploded, there had been no test of the airlock release, nor a test of a full reentry of the descent apparatus with the large airlock ring attached to the side of the capsule. The ground tests for these aspects of the mission were beset by failures. When a test version of the descent apparatus was air-dropped from a plane at Feodosiya, the parachute system failed, smashing the capsule into pieces. Another airlock, one built for the flight, was destroyed on January 13, when it was accidentally dropped during mating with the flight version of the 3KD. The spate of failures seriously unnerved all personnel. Severin recalls, "The situation was really grave. Almost the entire testing program had been disrupted. Only part of it was completed in the unmanned flight. . . ." ¹⁴⁹ There was even talk of postponing the flight until better results were obtained on the ground. The competition with Gemini reached such a state that Soviet security personnel arrived at Tyura-Tam. Severin recalls:

The Chairman of the KGB [V Ye. Semichastnyy] appeared unexpectedly at Baykonur [on February 20]. He arrived at the testing area and came up to us at the engineering site, where we were preparing the airlock. . . . It's possible that the KGB thought that all of our accidents were the result of imperialist intrigue. I don't know. But they established strict monitoring, which made us very nervous."

The reliability of landing a capsule with the large airlock ring installed was still an issue of great concern because Kosmos-57 had never had the opportunity to land. The ring apparently induced sharp rotations as high as one revolution per second around the main axis of the reentry capsule during descent by parachute. By late February, Korolev, Pilyugin, and Ryazanskiy proposed a new revised testing program that would include more ground tests as well as in-flight testing of the airlock ring. The chief designers received permission from the State Commission to equip a Zenit-4 reconnaissance satellite with the suspect ring. A safe landing by the military satellite would clear the way for a piloted launch. On March 7, a Zenit-4 was launched into orbit as Kosmos-59. The descent apparatus successfully landed on March 15, about 170 kilometers south of Kustanay in Kazakhstan. Although the on-board data recorder

¹⁴⁸ *Ibid* Yu A. Mozzhorin et al eds *Dorogi v kosmos II* (Moscow MAI 1992) pp 34–35 The accident commission was headed by TsUKOS Commander Maj. General K. A. Kerimov

¹⁴⁹ "To Save Man: A Conversation With the General Designer "

¹⁵⁰ *Ibid*

failed to record the rotations of the capsule during landing, indirect evidence suggested that the descent apparatus was subjected to only a forty- to 100-degree-per-second rotation— within the acceptable limits for a crew." The success was a much-needed boost to the morale of the engineers. Korolev wrote to his wife on March 8:

We are trying to accomplish all our work without hurry. Our chief motto is "the safety of the crew comes first." God grant us the strength and the wisdom to always live up to this motto and to never experience its opposite. I personally always believe and hope for the best outcome even though all my efforts, my mind, and my experiences are directed towards trying to foresee and outguess the worst that can happen— an ominous presence that stalks us every step into the unknown."

The mission of Kosmos-59 seems to have finally cleared the way for this "new step into the unknown." then scheduled for the third week of March 1965.

Under Tyulin's direction, the State Commission held a meeting at site 2 at Tyura-Tam on March 9 to discuss the composition of the crew who had arrived at the launch site the same day. Despite some reservations about Belyayev's health and his possible replacement by Khrunov, all unanimously approved Belyayev and Leonov as the primary crew. Khrunov would serve as the only backup cosmonaut, ready to take over from either of the primary members, as he had been trained for both positions." Korolev met with the cosmonauts on March 13, saying: "I want to caution you once more that the most important thing in your flight is to return to Earth healthy. We do not need thoughtless heroics."¹⁵⁴ The primary and backup crews and the flight program were formally approved at a State Commission meeting on March 16. The launch was set for either March 18 or 19, less than a week before the first piloted Gemini mission, Gemini III.

Korolev was beset by poor health throughout the last few weeks leading up to the launch. At one point, he had had to spend some time under medical attention because of a pulmonary inflammation. Nothing, of course, deterred him from his work, and looking tired and gaunt, he showed up for the launch on the morning of March 18. It was a cold and snowy day at Tyura-Tam. Belyayev and Leonov arrived at the launch, the former "as always, completely unperturbed" and the latter "visibly excited." Korolev, Gagarin, Kamanin and others were there to see the cosmonauts off. In a farewell message, Korolev told Leonov, "I won't give you a lot of advice and ask a lot of you Lyasha, just don't outsmart yourself. I only ask you one thing: just exit the ship and come back in, keeping in mind all the Russian sayings that have helped a Russian man during difficult times. May you have a fair solar wind."¹⁵⁶

The Voskhod 2 spacecraft, vehicle 3KD no. 4, was launched successfully at 1000 hours Moscow Time on March 18, 1965. On board were Colonel Pavel I Belyayev, thirty-nine, and Lt Colonel Aleksey A. Leonov, thirty. As with the earlier Voskhod mission, the tension during

151 Kamanin *Skrytiy kosmos 1964-1966* p 166

152 Golovanov *Korolev* p 749

153 The concerns about Belyayev's health were apparently misplaced. During a training session in the TDK 60 altitude chamber Belyayev had begun gasping for breath. Physicians had attributed the problem to Belyayev's health. It was later discovered that Belyayev was not receiving any oxygen because of a malfunction in the equipment. According to Kamanin Belyayev "displayed admirable composure, found the problem, and corrected it." See Kamanin "Pages From a Diary." Note that Kamanin had decided that backup cosmonaut Zaykin was not suitable for a primary crew.

154 *Ibtd*

155 *Ibtd*

156 Golovanov *Korolev* p 749 Lt Gen Georgiy Aleksandrovich Tyulin "Task for the Future: Notes of the State Commission Chairman" (English title) *Krasnaya zvezda* April 5 1988 p 4

the first few seconds was without measure. There were apparently numerous alarms during the ascent. Korolev, a non-smoker, lit up a cigarette once the spacecraft reached orbital velocity at T+530 seconds. Initial orbital parameters were 173 by 498 kilometers at a sixty-five-degree inclination. The two cosmonauts began preparations for the EVA as soon as they reached orbit. First, Belyayev expanded the Volga airlock to its full length. Then Leonov, aided by Belyayev, strapped on his life support backpack within the cramped capsule, making sure that all systems were operational. Once the pressure between the airlock and the ship was equalized, Belyayev flipped a switch to open the inner hatch. Leonov crawled head first into the airlock and hooked himself up to the 5.35-meter-long tether. After all the tests proved satisfactory, Belyayev commanded the first hatch shut and depressurized the airlock. Through all this strenuous activity, Belyayev kept up a constant stream of conversation, cautioning his crewmate, "Take it easy, Aleksey. . . . Be patient. Take it easy. . . ." ¹⁵⁷

Belyayev opened the external hatch by remote control just an hour and a half after liftoff, at 1132 hours, 54 seconds Moscow Time on March 18. Leonov was evidently impatient, eager to leave the airlock, and Belyayev had to order his pilot to stick to the preset program. Within two minutes, at 1134 hours, 51 seconds, Leonov emerged from the airlock, thus becoming the first human to walk in space. At first, he merely poked his head out, but then gradually pushed out his entire body. The Sun was evidently very bright, almost blinding, forcing the cosmonaut to squint as he held on to the outer rim of the spaceship. His first words upon entering free space were: "I can see the Caucasus." ¹⁵⁸ As Voskhod 2 was flying over the Black Sea, Leonov stayed with his EVA program and removed the cover from the camera on a boom outside the spacecraft. ¹⁵⁹ Toying with the cap, he eventually let it go, watching it fly into its own orbit. He removed one hand, then the other, and let go of the ship, floating out into space at 28,000 kilometers per hour over the surface of Earth. He recalled later:

It was an extraordinary sensation. I had never felt quite like it before. I was free above the planet Earth and I saw it — saw it was rotating majestically below me. Suddenly in the silence, I heard the words "Attention! Attention! Man has entered open space." ¹⁶⁰



These three stills are from the external movie camera on Voskhod 2, which recorded Aleksey Leonov's historic spacewalk in March 1965 (files of Asif Siddiqi)

157 Riabchikov *Russians in Space* p 219

158 *Ibid*

159 Golovanov *Korolev* p 749 Some sources suggest that he manually installed the camera on the out side of the ship. See, for example, Kenneth Gatland *Manned Spacecraft* (New York: Macmillan, 1976) p 135

160 "The Russian Right Stuff" NOVA television show

The Topaz TV camera mounted on the inflatable airlock transmitted live pictures of Leonov's movements, not only to Belyayev but also to ground control. Leonov apparently had a still photo camera attached to his spacesuit, and during his short jaunt into open space, he tried several times to depress the shutter to take pictures of the exterior of the spaceship but was unable to do so. After about ten minutes, by which point he was over the Pacific, Leonov began preparations for reentering the airlock. First, he removed the movie camera from the boom, but evidently he had great difficulty in placing it in the airlock. In returning to the airlock, Leonov was to enter feet first, thus allowing him to slip back into his seat from the other side of the airlock. The internal diameter of the airlock was not designed for a somersaulting cosmonaut. But after twelve minutes and nine seconds in open space, Leonov found himself in a difficult situation:

Near the end of my walk I realized that my feet had pulled out of my shoes and my hands had pulled away from my gloves. My entrance suit stretched so much that my hands and feet appeared to shrink. I was unable to control them. It was as if I had never tried the suit on even once.¹⁶¹

With little control over his limbs, he had trouble entering the airlock:

I couldn't get back in straightaway. My space suit had ballooned out and the pressure was quite considerable. I was tired and couldn't go in feet first as I had been taught to do. But using a valve... I decreased the pressure to just under 0.27 atmospheres. Then I felt freer and I could move about more easily. Then I pushed myself into the airlock head first, with my arms holding the rails. I had to turn myself upside down in the airlock in order to enter the ship feet first and this was very difficult."¹⁶²

Leonov's pulse was racing as high as 143 beats per minute, his breathing rate was twice normal levels, and his body temperature was up to thirty-eight degrees Centigrade. He was drenched in sweat and in serious danger of fatigue." An exhausted Leonov finally closed the outer hatch, pressurized the airlock, and opened his helmet in violation of instructions. After a short rest, he opened the inner hatch and slipped back into the descent apparatus. The outer hatch was closed at 1151 hours, 54 seconds, giving a total depressurized time of only twenty-three minutes and forty-one seconds.

Soviet leaders back in the Kremlin followed the EVA closely. It was the first big spaceflight of the new Brezhnev-Kosygin leadership, and as such, it was almost surely considered an important benchmark for future space programs. An operator from the main flight control center of the Strategic Missile Forces was driven twice to the Kremlin to explain the details of the EVA, which was piped in live on TV. Brezhnev, Kosygin, Mikoyan, Ustinov, and other members sat and watched the proceedings attentively. Brezhnev later recorded a congratulatory message for the two cosmonauts.¹⁶⁴

¹⁶¹ Thomas O'Toole "The Man Who Didn't Walk on the Moon" *New York Times Magazine* July 17 1994 pp. 26-29. The quote is on p. 28.

¹⁶² "The Russian Right Stuff" NOVA television show.

¹⁶³ The official medical report on the flight included the following: "During emergence from the lock into space and return to the ship, Leonov's heart rate was approximately 1.5 times higher than the rates observed during the training session and reached 150-162 per min." See Akulinichev *et al.* "Some Results of Medical Supervision" p. 289. See also Colovanov *Korolev* p. 750.

¹⁶⁴ Mozzhorin *et al.* eds. *Nachalo kosmicheskoy ery* pp. 323-24.

Having completed the primary task of the flight, the crew cast off the concertina-shaped airlock and settled down to a one-day mission, not unlike that of the first Voskhod. The ejection of the airlock seems to have imparted a twenty-degree-per-second rotation rate to the spacecraft, several times greater than the nominal rate. The State Commission, after consulting with the crew, decided to rectify the rotation only prior to landing, possibly to conserve attitude control propellant. There was another problem: the EVA exit hatch on the ship had not been shut tight completely, causing an automatic mechanism on the spacecraft to overcompensate for the incremental drop in air pressure. Instead, the life support system filled the interior of the ship with oxygen, which reached levels as high as 45 percent. The danger was obvious: a tiny spark could set off a fire and explosion within the ship. The two men spent much effort trying to lower the oxygen content during the remainder of their mission, apparently managing to bring it down to manageable levels before the planned reentry. In terms of science, there were some minor experiments related to color perception in microgravity. The crew apparently also carried out some movie and still photography. The usual complement of biological samples was also carried aboard.¹⁶⁵

The problems with the mission continued to accumulate as reentry approached. By the thirteenth orbit, pressure in the cabin pressurization tanks had dropped from seventy-five to twenty-five atmospheres, raising the threat of a complete decompression of the spacecraft. After careful analysis, Chief Designer Grigoriy I. Voronin, responsible for the life support systems, "firmly stated that the pressure in the craft's cabin could not fall below 500 millimeters, in which case there would be more than enough oxygen for three hours"—that is, until landing on the seventeenth orbit. Belyayev reported on the fourteenth orbit that the pressure had indeed stabilized at twenty-five atmospheres, although it seems that oxygen content was still sufficiently high to have made the last few hours nerve-racking for both ground controllers and the crew. Every minute was an agony as the specter of cosmonaut Bondarenko's death in a pressure chamber four years before passed through everybody's minds.¹⁶⁶

On the seventeenth orbit, the controllers, along with Korolev, Keldysh, Tyulin, and Gagarin, waited expectantly for word that the reentry burn had occurred on time. After some tense minutes, Belyayev calmly reported. "Negative automatic retrofire"—meaning that the retrorocket engine had not engaged.¹⁶⁷ Within seconds, the controllers conjectured that the solar attitude control sensor had malfunctioned: a circuit to prevent retro-engine ignition in such cases had operated as planned. As the tension in the control room began to rise, there was a brief flurry of conversation among the leading members of the State Commission. The question was: What should we do now? An engineer at the control room recalled:

No one understood what the problem was. There were many guesses, frantic proposals—everyone had clearly begun to get nervous. . . . Korolev took supervision into his own hands. He established silence and asked everyone to sit down. Then he calmly listened to the work supervisor in charge of the control system. He asked him to tell him the possible causes and to give a suggestion for further action.¹⁶⁸

165 These included human lung cancer cells, frog ova and sperm, *drosophila melanogaster* insects, *tridesantia paludosa* plants, winter wheat and pine seeds, chlorella algae, and bacteria. See Wukelic, ed., *Handbook of Soviet Space-Science Research*, pp. 346–48. For general descriptions of their time in orbit, see Kamanin, *Skrytiy kosmos: 1964–1966*, pp. 167–69; Colovanov, *Korolev*, p. 751.

166. Golovanov, *Korolev*, p. 751; M. F. Rebrov, *Kosmicheskiye katastrofy Russkryesensatsii* (Moscow: Izdat., 1993), p. 38; Kamanin, "Pages From a Diary."

167. Tyulin, "Task for the Future."

168. Ishlinskiy, ed., *Akademik S. P. Korolev*, p. 486.

After a short conference, Korolev proposed that Belyayev use the manual system of orientation for reentry. OKB-1 Deputy Chief Designer Yevgeniy V. Shabarov, responsible for flight testing, and control systems engineer Boris V. Raushenbakh began a frantic race to gather the necessary data to transmit to the crew to carry out manual reentry. Once the data were found, the numbered code was written on a piece of paper and signed by each of the engineers. The paper was then handed to Gagarin who, under Korolev's direct orders, transmitted the information to Belyayev." Ballistics computations showed that the landing could be achieved on the eighteenth, twenty-second, or twenty-third orbit. In all cases, the landing area would be well north of the nominal site.

The exercise in simply orienting the spacecraft into its correct attitude using the Vzor optical device became an ordeal in itself, exacerbated by the fact that both men were clad in bulky spacesuits. In the cramped quarters of the ship, Belyayev had to place himself horizontally across both seats of the capsule, while Leonov remained out of the way *under* his seat. At the same time, Leonov manually held Belyayev in place so as to keep Belyayev in front of the orientation porthole. That way, Belyayev could use both his hands to orient the ship to Earth's terminator using hand controls. Having completed this task, both men quickly returned to their seats to reestablish the ship's center of gravity before firing the deorbit engine. It took the two men a whole forty-six seconds to get back into their original positions before Belyayev hit the engine fire button. This forty-six-second delay caused a serious overshoot of their original targeted landing point.¹⁷⁰ Other reliable accounts suggest that only Belyayev managed to get back into his seat by the time of engine ignition. Leonov was evidently still out of his seat, thus displacing the ship's center of gravity, raising the specter of a wildly spinning capsule reentering the atmosphere. In an amazing stroke of luck, the ship did not spin out of control, probably saving the lives of the cosmonauts.

The ordeal did not end there. As in several previous Vostok missions, the instrument compartment failed to separate from the descent apparatus: the two modules remained connected to each other loosely with steel straps. The unsteady mass of the two rocking modules linked to each other did not produce the required lift for a nominal ballistic trajectory. Instead, the capsules headed on a steep trajectory with severe loads on their bodies. The gravitational force burst blood vessels in both men's eyes as the load reached ten g's. Each man felt as if they weighed about 700 kilograms for a few seconds."¹⁷¹

Control centers at both Tyura-Tam and Moscow received word that the capsule had landed, but for an agonizing four hours, there was no communication on the health of the crew. One thing was clear: the ship had landed way off course in the dense forests of the Russian tayga. One of Korolev's greatest fears was that if the capsule landed in a densely forested area, the soft-landing sensor at the base of the descent apparatus would "think" that the ship was near ground if it hit a tree branch high up in the air. With such a premature firing, the capsule would hit the ground with a thunderous impact, seriously injuring the crew. Fortunately, one of the pilots in a search helicopter reported:

On the forest road between the villages of Sorokouaya and Shchuchino, about 30 kilometers southwest of the town of Berezniki. I see the red parachute and the two cosmonauts. There is deep snow all around. . . . The craft touched down in dense woods, far from any population center.¹⁷²

169. Mozzhorin, et al., eds. *Dorogi v kosmos* I, p. 179

170. Kamanin, *Skrytiy kosmos 1964-1966*, pp. 190, 197.

171. Colovanov, Korolev, p. 752; O'Toole, "The Man Who Didn't Walk on the Moon "

172. Kamanin, "Pages From a Diary."

The mission had ended with touchdown at 1202 hours Moscow Time on March 19, 1965, after a one-day, two-hour, two-minute mission. The ship had landed 386 kilometers from the designated target area, about 180 kilometers northwest of the town of Perm. The area in which they landed was so densely packed with trees that it was impossible for helicopters to land. Instead, thermal flight clothing was dropped from one helicopter while another landed five kilometers away. The area was completely covered with snow, and the temperature was minus five degrees Centigrade. The cosmonauts themselves had no clue where they were, being surrounded by dense forests and snow two meters deep at places. When Leonov asked how soon rescuers would pick them up, Belyayev joked. "Maybe in three months, they'll pick us up with dog sleds." A helicopter found a place to land about five kilometers from the landing point, and a search team set off on foot to find the capsule. Another team in two vehicles from the Air Defense Forces was meanwhile attempting to reach the crew on land. Both parties were unable to find the spaceship before nightfall and had to cut short their searches. Fortunately for Belyayev and Leonov, a helicopter had dropped thermal clothing for the cosmonauts earlier during the day.

The men spent an extremely frigid and uncomfortable night in the woods. In the morning, a helicopter once again flew over the landing site and reported that two people, both wearing flight clothing, were spotted near the landing site, one chopping wood and the other arranging branches to start a fire. At 0730 hours, a group headed by a Colonel Sibiryak of the Air Defense Forces disembarked from an Mi-4 helicopter with the objective of reaching the crew on skis. It took the group three hours to cover the one and a half kilometers to the descent apparatus, finally arriving around 1030 hours. The cosmonauts were reported to be in good condition with no injuries. A twist was added to the whole rescue operation by the insistence of Soviet Air Forces Commander-in-Chief Marshal Vershinin that the crew only be evacuated by motorcycle, or if that was not possible, then by helicopter, but only if it landed near the capsule. Despite fierce objections from both Korolev and Kamanin, who advocated simply hoisting the cosmonauts onto hovering helicopters, the cosmonauts were forced to spend an additional night in uncomfortable conditions. Even Korolev's attempts at convincing the Soviet leadership were in vain; Vershinin had told Brezhnev that hoisting them to a height of five to six meters might be dangerous. The irony was that they were only three or four hours away from Tyura-Tam.¹⁷⁴

The second night was more comfortable, as the cosmonauts had additional food, clothing, and tents. Finally, at around 1000 hours on March 21, Belyayev and Leonov arrived at Perm airport in an Mi-6 helicopter on their way to Tyura-Tam. At the launch range, all the leading personalities involved with the flight, including Korolev, Keldysh, Tyulin, Rudenko, Pilyugin, Barmin, Kerimov, and Kamanin, had gathered to greet the crew on their arrival. There was a mixture of euphoria and relief in the air as the months of grueling work had finally paid off in yet another spectacular advance for the Soviet space program. Korolev raised a toast to the future: "Friends! Before us is the Moon. Let us all work together with the great goal of conquering the Moon. Do you remember how our collective worked in such a friendly manner?" This evidently elicited a quiet but sarcastic comment from Chief Designer Barmin, who muttered, "We worked in a friendly manner when we were all leaders. . . . Now there's one head theoretician [referring to Keldysh] and one head designer. . . ." ¹⁷⁶

173. O'Toole. "The Man Who Didn't Walk on the Moon." p. 29

174. Kamanin. "Pages From a Diary."

175. Kamanin. "In the Future His Name Will Probably Be . . ." p. 28

176. *Ibid*

The cosmonauts finally arrived at Tyura-Tam at 1730 hours, both in good moods. On the morning of March 22. Belyayev and Leonov briefed the State Commission on their mission. They were then flown to Moscow for a massive government reception in Moscow held the following evening. The requisite postflight press conference became the subject of much dispute, when Kamanin insisted that the truth be told about the cosmonauts' daring landing ordeal. As was typical, the more conservative Academy of Sciences President Keldysh was adamantly opposed, demanding that Belyayev write in his report to the press that the spacecraft landed at the precisely designated site, but had spent two days "resting" at the landing area. Kamanin was supported in his crusade by Korolev, but it seems that the latter's entreaties to Keldysh and Smirnov did not make a difference. The press conference on March 26 at the assembly hall of Moscow State University was filled with generalizations and half-truths. Keldysh maintained tight control over the proceedings. At one point, Belyayev was forced to say that the cosmonauts had been "delighted" that the automatic system of orientation had failed, because this provided them with an opportunity to use the manual system.¹⁷⁷ Belyayev also added that the Voskhod-class ships could change orbits in space, a blatant lie that was repeated by Keldysh in a journal article the following month.¹⁷⁸ The references to orbital maneuvering were clearly aimed to take the wind out of the Gemini III flight, when for the very first time a piloted spacecraft had changed orbits.

Cosmonaut chief Kamanin was party to an even more bizarre postscript to the Voskhod 2 mission at the premiere showing of the Leonov EVA film in Moscow on August 24, 1965. a couple of months after NASA astronaut Edward H. White II carried out the first American spacewalk. Kamanin announced that the White spacewalk had benefited greatly from information supplied by the Soviets. He added, "A small group of American specialists, with the permission of our government came to the Soviet Union and talked with Belyayev and Leonov about their flight, and we didn't hide anything." When a reporter asked who these "American specialists" were. Kamanin replied that either three or five persons had interviewed the Soviet cosmonauts for several days, but that he could not remember their names! Asked if the Americans were from NASA. Kamanin answered, "I don't know. . . . Officially, they were here with a television company—allegedly."¹⁷⁹

The postflight hyperbole at the press conference did not in any way diminish the value of the Voskhod 2 mission. The flight was a major landmark not only for the Soviet space program. but for the human exploration of space as a whole. The importance of the event is more magnified by the story of the amazing resourcefulness of Soviet engineers and cosmonauts—a story that was hidden from the public for a quarter of a century. The Voskhod 2 flight had two other distinctions, neither of which were clear when Korolev raised his toast to the Moon. The first was the astonishing fact that the Soviets would not launch a single piloted space mission in the following twenty-four months, one of the longest gaps in the history of the Soviet space program. Voskhod 2 was, in effect, the last in the series of spectacular flights that had raised the specter of Soviet domination in space. It was the absolute zenith of the Soviet space program, one never, ever attained since. Voskhod-2's second distinction was of a more personal nature: it was Korolev's swan song. As he turned to finally run hard in a race to the Moon against the United States, he had little hope of knowing that he would not live to see another Soviet cosmonaut launched into space. It was truly the end of an era.

177 *Soviet Space Programs 1962-65* p 557

178 See *Priroda* (April 1965) 9-16 referenced in *ibid* p 365 A Soviet journalist also reported in *Pravda* on March 19, 1965 that "This spacesuit may be used for prolonged work in space and for landing on the lunar surface"

179 "Russian Suggests Soviet Data Helped U.S. 'Walk' in Space" *New York Times* August 25 1965 p 24 Kamanin also wrote about this claim in his diary entry for October 20 1965 See Kamanin *Skrytiy kosmos 1964-1966* p 241

CHAPTER ELEVEN

THREE STEPS TO THE MOON

When cosmonauts Belyayev and Leonov landed after their historic Voskhod 2 mission, it had been approximately four years since the first flight of Gagarin in 1961. Each of the eight piloted missions during that period had been proposed, directed, and executed under the auspices of one organization using essentially a single model of spacecraft. In this respect, the year 1965 was a watershed point in the history of the Soviet piloted space program, as several new vehicles were put on the drawing boards for a variety of long-range goals, including civilian and military operations in Earth orbit, circumlunar flight, and a lunar landing. The most important of these was a spacecraft that would eventually fly more missions than any other spaceship built in the Soviet Union, the Soyuz.

A New Direction for Soyuz

OKB-1 Deputy Chief Designer Konstantin D. Bushuyev. Korolev's *de facto* assistant for all piloted space projects, oversaw the early work on the 7K-9K-11K Soyuz program. Bushuyev and Korolev's First Deputy Mishin had come up through the same ranks. They graduated together from the Moscow Aviation Institute in the 1930s and joined Bolkhovitinov's rocket-plane group in the 1940s at the same time. The two would have gone to Germany together, but Bushuyev's wife's brother had been killed by lightning at the time, and Bushuyev had to attend the funeral. Later, Mishin invited Bushuyev to Kaliningrad to join Korolev's rocket design group. It was here that he would make his mark, working on a variety of design problems during the 1950s, including missile nose cones.

Bushuyev had a remarkably reticent and unassuming personality. He did not drink, he exercised regularly, and he liked to go hiking into the woods—a pleasure he rarely shared with anyone. Unlike many of his contemporaries, he never wore any of his medals and awards at official ceremonies, preferring to remain in the background. He may have been Korolev's principal aide for piloted space projects, but the two men had a very complex relationship. Russian historian Yaroslav K. Colovanov, who knew Bushuyev, wrote about him:



OKB-1 Deputy Chief Designer Bushuyev was the senior person at the design bureau responsible for piloted space programs. His identity was revealed in 1971 when the Soviets announced that he would head the Soviet team participating in the Apollo-Soyuz Test Project. This photo dates from early 1972. [NASA photo]

To be quite honest, I was never able to understand why Korolev would *have* named Bushuyev as his deputy for all space projects, or in other words—for all the projects which were closest to *Korolev's* heart. It was well known that Korolev treated Bushuyev with the utmost severity, and at times was downright unjust, that Korolev treated Bushuyev at times like an errant delivery man. Bushuyev was, in fact, the *very* anti-thesis of Korolev in character, behavior, and interpersonal relations.¹

Bushuyev apparently considered resigning from the design bureau many times, but ultimately Korolev would invariably "call Bushuyev into his office and calmly, even gently—and what is more, with genuine trust—involve him in a discussion, ask for his views, share his own quandaries. . . ." In the end, Bushuyev stayed on.

In June 1959, Korolev sent Bushuyev to the so-called "Second Territory" in Kaliningrad, a recently acquired artillery plant with 5,000 new employees, to focus on spacecraft and solid-propellant ballistic missiles.² By late 1962, the Second Territory had come to focus exclusively on space-related projects, and Bushuyev took charge of a variety of important OKB-I programs. He did not stay there very long. One story is that someone hinted to Korolev about Bushuyev's alleged ambitions to separate his branch from the main OKB-I center, leaving Korolev to focus only on the development of missiles. Others claim that Bushuyev, although a brilliant engineer, was simply a poor manager. Either way, Korolev pulled the plug. In May 1963, Korolev abruptly ordered Bushuyev back to the central location to oversee other profiles at the giant organization.³

Perhaps to preclude any of his other deputy chief designers from harboring dreams of carving out a piece of the pie, Korolev redistributed various space-related programs across both the main OKB-I center and the affiliate Second Territory. The Soyuz program came under the direction of Deputy Chief Designer Sergey S. Kryukov, also responsible for the NI rocket, while Boris Ye. Chertok, one of Korolev's most seniormen, was sent off to head the Second Territory. Chertok, fifty-one years old at the time, was the overseer of all work at the enterprise on control, guidance, and orientation systems for spacecraft and missiles. A tall, balding man with a powerful voice, he was also one of the few Jewish men in the top ranks of the Soviet space designers. He was born in the Polish town of Lodz, and he developed an interest in radio during his adolescence. In the 1930s, Chertok found a job at Plant No. 22 outside Moscow, the same plant that is today known as the M. V. Khrunichiev State Space Scientific-Production Center. In 1946, he joined the famous NII-88. During Stalin's later years, then-Minister of Defense Industries Ustinov saved Chertok from imprisonment by demoting him to an innocuous position to divert attention away from his Semitic background. As his power grew within the Soviet space program, Chertok, like many of his other contemporaries, was allowed to write about space in the Soviet media in later years, but under the pseudonym "Boris Yevseyev." After the shakeup in 1963, Chertok was closely involved in the development of the Soyuz and was instrumental in saving the program from oblivion.



Boris Chertok was a Deputy Chief Designer at OKB-I who participated in several key Soviet space projects such as Soyuz. In later years, he was also one of the principal flight controllers for piloted space missions at the Yeupatoriya center (files of Peter Gorin)

- 1 Yaroslav Colovanov *Korolev fakty i mify* (Moscow Nauka 1994) pp 589-90
- 2 B Ye Chertok *Rakety i lyudi Fili Podlipki Tyuratam* (Moscow Mashinostroyeniye 1996) pp 275-76
- 3 Golovanov *Korolev pp 589-91 Chertok. Rakety i lyudi Fili Podlipki Tyuratam p 276 Yu P Semenov ed Raketno Kosmicheskaya Korporatsiya "Energiya" imeni S P Koroleva* (Korolev RKK Energiya named after S P Korolev 1996) p 167

CHALLENGE TO APOLLO

By the first months of 1964, OKB-1's Department No. 11, subordinated to Deputy Chief Designer Kryukov, had redesigned the basic 7K Soyuz spacecraft for flying not two, but three cosmonauts. Technical documentation for the vehicle had been prepared in early 1964, and by the spring, the first "boilerplate" had rolled off the plant at Kaliningrad. When Korolev first viewed the spacecraft, he allegedly told everyone present that "this was the machine of the future."⁴ A full-size trainer of the 7K, along with one-thirtieth-size models of the 9K and 11K, was installed at TsNII-30 in Noginsk by February 1964 to allow cosmonauts to rehearse docking procedures in orbit.⁵ A stripped-down mock-up of the Soyuz descent apparatus was also prepared for a suborbital flight from the old proving range at Kapustin Yar. OKB-1 engineers launched the mock-up on the morning of September 26, 1964, to test the aerodynamic qualities of the capsule, but the payload shroud broke up between T+33 and T+39 seconds because of excessive aerodynamic loads.⁶

Despite the advances in the Soyuz effort, the program was stopped dead in its tracks less than a year after it had received a formal go-ahead in December 1963. When in August 1964 the Soviet Communist Party and government selected Chelomey to carry out the circumlunar program, Soyuz effectively fell through the cracks. There were other factors—for example, Korolev was knee-deep in a variety of unrelated projects at the time, including the interim Voskhod missions. In addition, primary operations for piloted lunar exploration at OKB-1 had shifted subtly from circumlunar projects to a lunar landing effort, more specifically the N1-L3 project. By the second half of 1964, the overall Soyuz program was "practically paralyzed," and it was ready to join the many other projects of the time as a footnote in Soviet space history.

In the fall of 1964, Korolev established a small group under Chertok to come up with proposals on the potential use of the basic 7K Soyuz spacecraft. In late 1964, Chertok's team suggested that the docking of two 7K vehicles in Earth orbit should be considered the primary goal of a redirected Soyuz program. Such a docking mission would aid in the development of rendezvous and docking systems, as well as provide experience in carrying out EVA operations in orbit from one Soyuz to another. Although the experiment had merits of its own, there were more pragmatic reasons for picking such a project as the primary goal of the Soyuz program. In early conceptions of the N1-L3 landing project, the engineers had proposed an elaborate scheme of crew transfer from one spacecraft to the other in lunar orbit via EVA. The 7K Soyuz could test out this complicated maneuver in Earth orbit before actual operations in lunar orbit.

In February 1965, Korolev presented his new conception of the Soyuz program, restructured from a circumlunar objective to operations in Earth orbit, to the Scientific-Technical Council of the State Committee for Defense Technology. The "ministry" granted approval for the program, taking into account that the design bureau had already finished the initial technical plan for the 7K vehicle, that it had been coordinated with a specific launch vehicle, that engineers had issued the complete design documentation, and that the manufacturing of portions of the vehicle had already begun. The 7K Soyuz would also enable cosmonauts to master complex Earth-orbital operations as a true second-generation spacecraft to follow the Vostok.⁷

4 Semenov ed *Raketno Kosmicheskaya Korporatsiya* p 168

5 N. P. Kamanin *Skrytiy kosmos kniga utoraia 1964-1966gg* (Moscow Infotekst IF 1997) p 24
Viktor Mitroshenkov *Zemnya pod nebom* (Moscow Sovetskaya rosstiya 1987) p 330

6 Yu. V. Biryukov "Materials from the Biographical Chronicles of Sergey Pavlovich Korolev" (English title)
in B. V. Raushenbakh ed *Iz istorii Sovetskoy kosmonautiki* (Moscow Nauka 1983) p 251 V. Semenov, I. Marmm
and S. Shamsutdinov *Iz istorii kosmonautiki uypysk II zapuski kosmicheskikh apparatov po programmam
pilotiruyemykh poletov* (Moscow AO Videokosmos 1995) p 51 E-mail correspondence Igor Lissov to the author
June 10 1997 This was evidently the first launch of the R 5V variant of the R 5 missile

7 Semenov ed *Raketno Kosmicheskaya Korporatsiya* pp 168-69

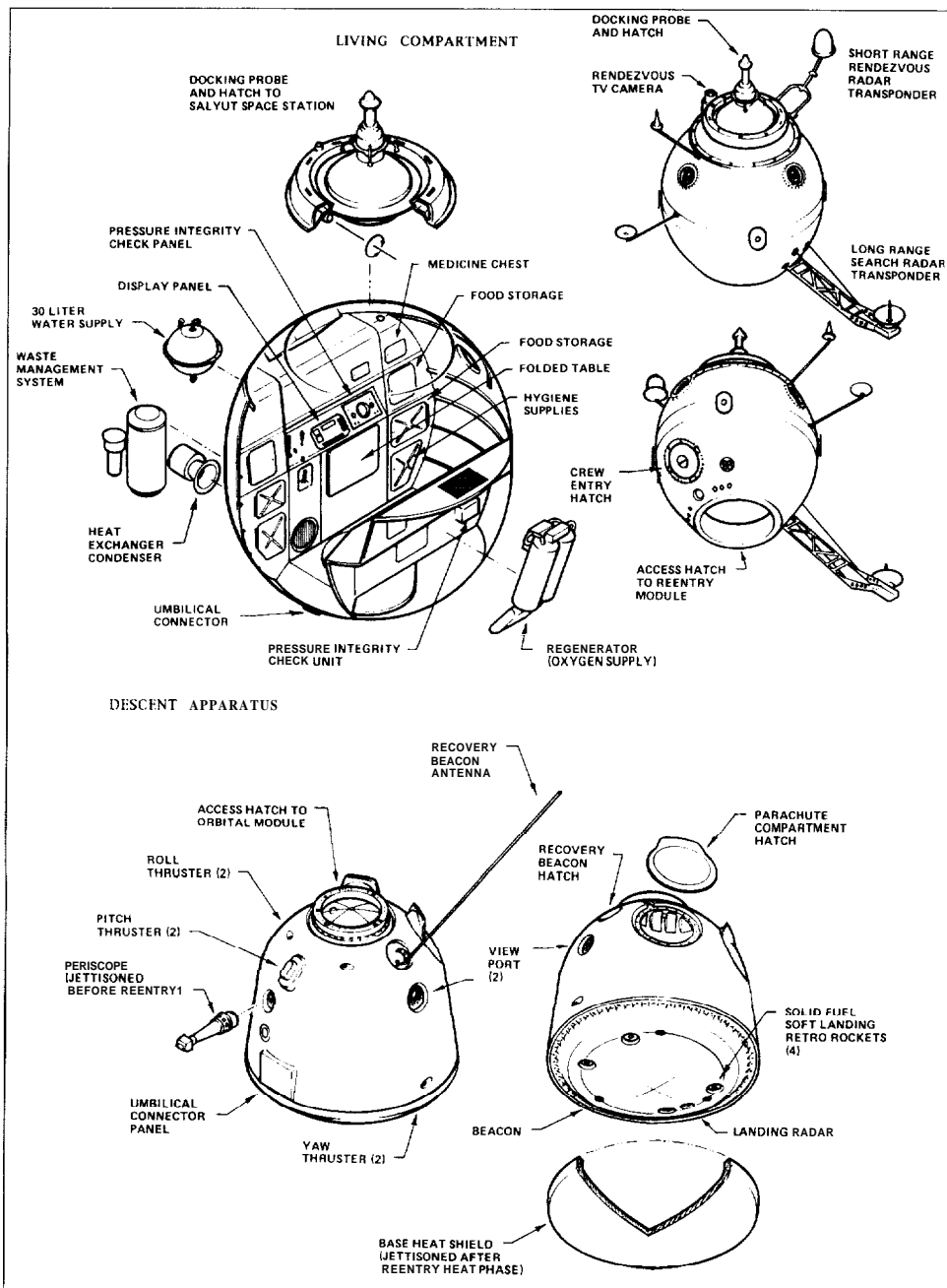

This and the next page show the three main sections of the Soyuz spacecraft. This particular model is the 7K T, a slightly different variant than the 7K OK which was used during 1966-70. The primary difference was in the docking equipment. At the top of this page is the living compartment which provided life support functions during independent flight. At the bottom of this page is the descent apparatus which carried the crew during launch and recovery. The next page shows the Instrument aggregate compartment which provided electrical power, thermal control, attitude control, and maneuvering capability. (copyright D R Woods)

CHALLENGE TO APOLLO

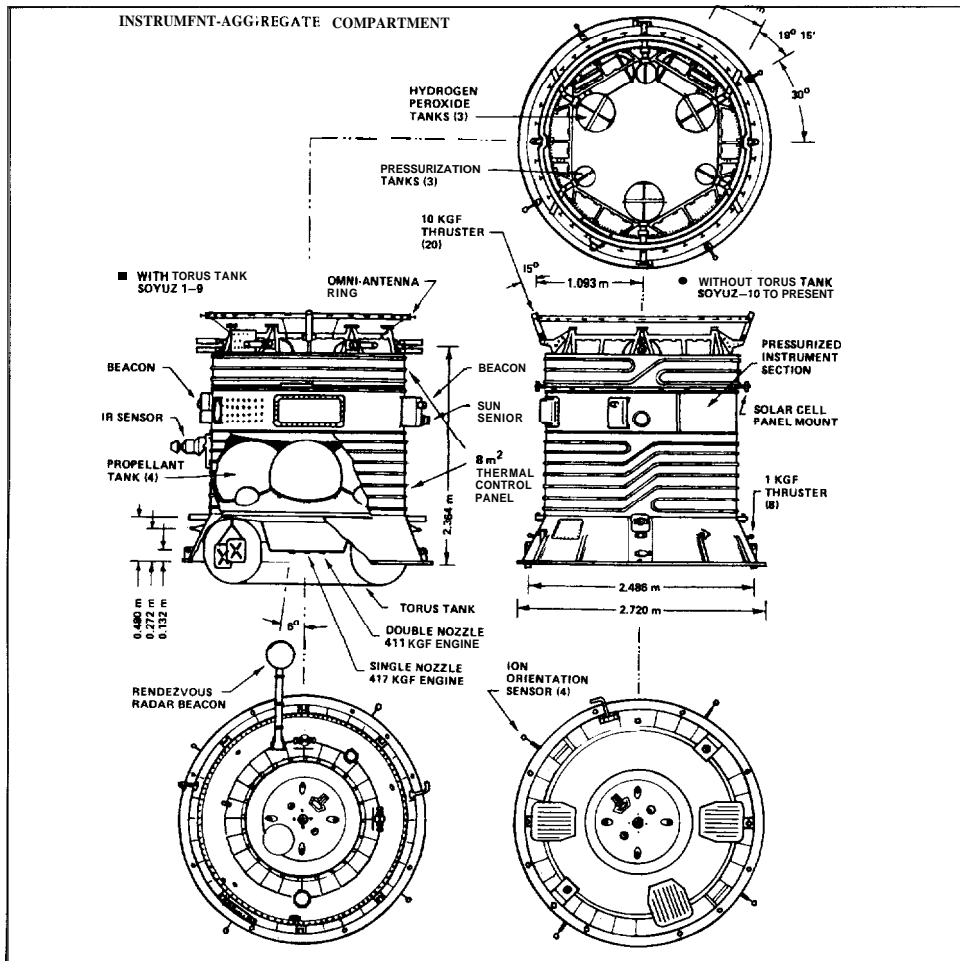

In early 1965, all work on the Soyuz spacecraft was moved to Department No. 93 at OKB-1. As per Chertok's original recommendations, the Soyuz program was reduced to the development of a single spacecraft, the product 7K-OK, with the "OK" standing for the Russian acronym of "orbital ship." Like all other missiles and spaceships, the vehicle also had a production index, the 11F615, which was the designation used in all plant documentation. The two remaining portions, the 9K tanker and the 11K translunar-injection (TLI) block, which would have been developed by other design bureaus, were eliminated from the program. Engineers delivered the draft plan for the 7K-OK ship in May; because of delays it was not until October 23 that they completed a final version, thus allowing designers to issue the technical documentation for the manufacture of the spacecraft. A new tactical-technical requirement was issued by the chief client, the Ministry of Defense, in August 1965."

The 7K-OK variant was an evolutionary design stemming from the years of work on the abandoned Sever. LI, and 7K spacecraft in the early 1960s. It would be this model, publicly called the Soyuz, that the Soviet Union would launch on thirty-eight piloted flights between 1967 and 1981.

8. *Ibid.*, p. 636

The general design scheme of the 7K-OK variant was quite similar to the original 7K variant intended for circumlunar missions. Like its predecessor, the spacecraft had three major compartments from the forward end to the rear end, the living compartment, the descent apparatus, and the instrument-aggregate compartment. The descent apparatus and the instrument-aggregate compartment retained their earlier shapes, but the living compartment was redesigned to be more like a spheroid rather than the earlier cylinder because the former provided a better mass-volume ratio. The total length of the spacecraft was about just over seven and a half meters, and total mass was 6,460 to 6,560 kilograms, up from the Vostok's modest 4,800 kilograms. A nominal mission would last three to ten days.

The cylindrical instrument-aggregate compartment—often called the "service module" in the West—like the one on the 7K, was divided into four separate sections along the length of its cylinder from the aft end to the forward end: the jettisonable compartment, the aggregate compartment, the instrument compartment, and the transfer compartment. The jettisonable compartment was a remnant of the original 7K vehicle's mission: circumlunar flight. It was originally a toroidal section at the base of the vehicle that would carry electrical systems for rendezvous and docking and be discarded following translunar injection. In redesigning the 7K to the 7K-OK, early models of the Soyuz evidently retained this compartment for chemical batteries, while all rendezvous and docking instrumentation was moved to the spheroid living compartment at the forward end of the vehicle.

The unpressurized aggregate compartment carried the thermo-regulation radiator system, the main and attitude control engines of the spacecraft, and two large solar panels (which charged the chemical batteries in the spacecraft). Each solar array was made up of two four-segment wings approximately a little more than three and a half meters in length, with a total surface area of fourteen square meters, that would provide thirteen and a half volts, for a total of twenty-seven volts. The solar arrays were folded up flat against the side of the aggregate compartment during the launch phase, unfurling to their full lengths once in orbit. During an Earth-orbital mission, the panels would be turned toward the Sun by orienting the entire vehicle by means of a solar sensor system and attitude control engines. The aggregate compartment also contained the main 7K-OK engine, located at the center rear of the spacecraft. This engine, the S5.35, had a thrust of 417 kilograms. The system also included a backup engine with two additional nozzles around the main exhaust, with a thrust of 411 kilograms, operating from the same propellant supply. The propellants of unsymmetrical dimethyl hydrazine (fuel) and nitric acid (oxidizer) were carried in four spherical tanks mounted at the base of the aggregate compartment. The engine's development had begun in 1962 for the original 7K variant at OKB-2 in Kaliningrad. In addition to the main engine system, the Soyuz also carried a set of twenty-two attitude control motors. Of these, ten thrusters of ten kilograms thrust were placed on the exterior of the transfer compartment; four at ten-kilogram thrust and eight at one-kilogram thrust were installed elsewhere. A backup system of eight thrusters consisted of four at one-kilogram thrust and four at ten-kilogram thrust.

Forward of the aggregate compartment was the instrument compartment, a pressurized section containing the guidance and rendezvous system instrumentation, radio communications systems, environmental control systems, and attitude control engines on the exterior. The final section, the transfer compartment, was a small part of the spacecraft, located between the crew capsule and the service module, carrying hydrogen peroxide tanks for the attitude control thrusters.

The complete instrument-aggregate compartment had a mass of 2,560 kilograms. The cylinder had a diameter of 2.2 meters flaring out to a skirt-shaped base, with a diameter of 2.72 meters for attaching to the upper stage of the launch vehicle. The length of this section, including all its four sections, was approximately 2.3 meters.

The descent apparatus—that is, the crew module—was affixed forward of the instrument-aggregate compartment. Affording an internal habitable volume of two and a half cubic meters.

the capsule included one, two, or three seats for the crew, depending on the mission. The shock-absorbing seats were angled at eighty degrees to the horizontal. Forward of the center seat, belonging to the commander of the crew, was the main instrument panel, comprising only readouts and visual displays of various on-board systems; most system operations were pre-programmed or controlled from the ground. The panel also included the *Globus* instrument for identifying the location of the ship over the planet, a TV screen used in conjunction with two TV cameras on the exterior of the spacecraft, and the *Vzor* viewfinder for use during attitude control maneuvers. The *Vzor* was connected to a periscopic protrusion from the top of the descent apparatus, which allowed the crew to orient the ship relative to Earth. Two joysticks—the left one for changing velocity during maneuvers and the right one for attitude control—were located below the main panel. There were two smaller control panels on each side of the main one, each called a command and signal instrument (KSU). These included switches for various primary and backup systems and medical instrumentation—that is, a means for allowing the crew to tweak with on-board functions. Of the approximately 200 buttons and 250 warning lights on the control panels, seventy and ninety-SIX, respectively, were for the spaceship's movement—for attitude orientation, rendezvous and docking, and reentry. The lights had a fairly rudimentary system of operation, with red denoting failures and green and blue for various states of nominal operation. A fourth set of switches was installed below the left KSU for regulating the spacesuit environment in the case of accidental depressurization. All the control panels were designed and built by the Special Experimental Design Bureau of the Flight-Research Institute headed by Chief Designer Sergey G. Darevskiy, the same institution that was responsible for the development of ground simulators.

Apart from the couches and control panels, the crew module also included a black-and-white TV camera at 625 lines per frame and twenty-five frames per second, one among a total of four in the Soyuz spacecraft as part of the *Krechet* system. Two others were fixed outside the ship for use during rendezvous, and one was inside the living compartment. One porthole on each side of the capsule was for visual cues during rendezvous as well as for celestial observations. For attitude control prior to and during reentry, six ten-kilogram-thrust hydrogen peroxide micro-engines were installed in pairs on the exterior at critical points for pitch, roll, and yaw. These would come into use once the module had separated from the instrument-aggregate compartment. The base of the crew module consisted of an outer shield manufactured from high-temperature-resistant ablative material for protection during reentry. After passage through the atmosphere and the opening of parachutes, this heat shield would be discarded, exposing the actual base of the descent apparatus, equipped with a set of solid-propellant engines for ensuring a soft-landing.

The precise shape of the descent apparatus was determined not only by the earlier studies on "headlight-shaped" modules in the early 1960s, but also by studies at the NII-1 aeronautics institute, where scientists by 1964 had developed a highly efficient principle of guided reentry using a low lift-drag ratio. NII-1 also contributed to computations of heat exchange and thermal protection, which were confirmed by experimental results. The crew capsule had a nominal mass of 2,800 kilograms and a length of two and two-tenths meters.

Directly forward from the center couch of the descent apparatus was the circular hatch leading to the spheroid living compartment, often called the "orbital module" in the West. It had a mass of 1,200 kilograms and a maximum diameter of two and a quarter meters. The module had a bunk, a cupboard, certain elements of the life support systems, a control panel for operating scientific instruments, TV cameras, hatch controls, spacesuit functions, radio equipment, and so on. Given a particular mission, spacesuits would be packed below the cupboard for the cosmonauts to don in the compartment. The cupboard could carry a food and water supply for a potential month-long mission. Internal volume for the crew was six and a half cubic meters. The living compartment also had four portholes and a set of rendezvous antennas on the exterior.

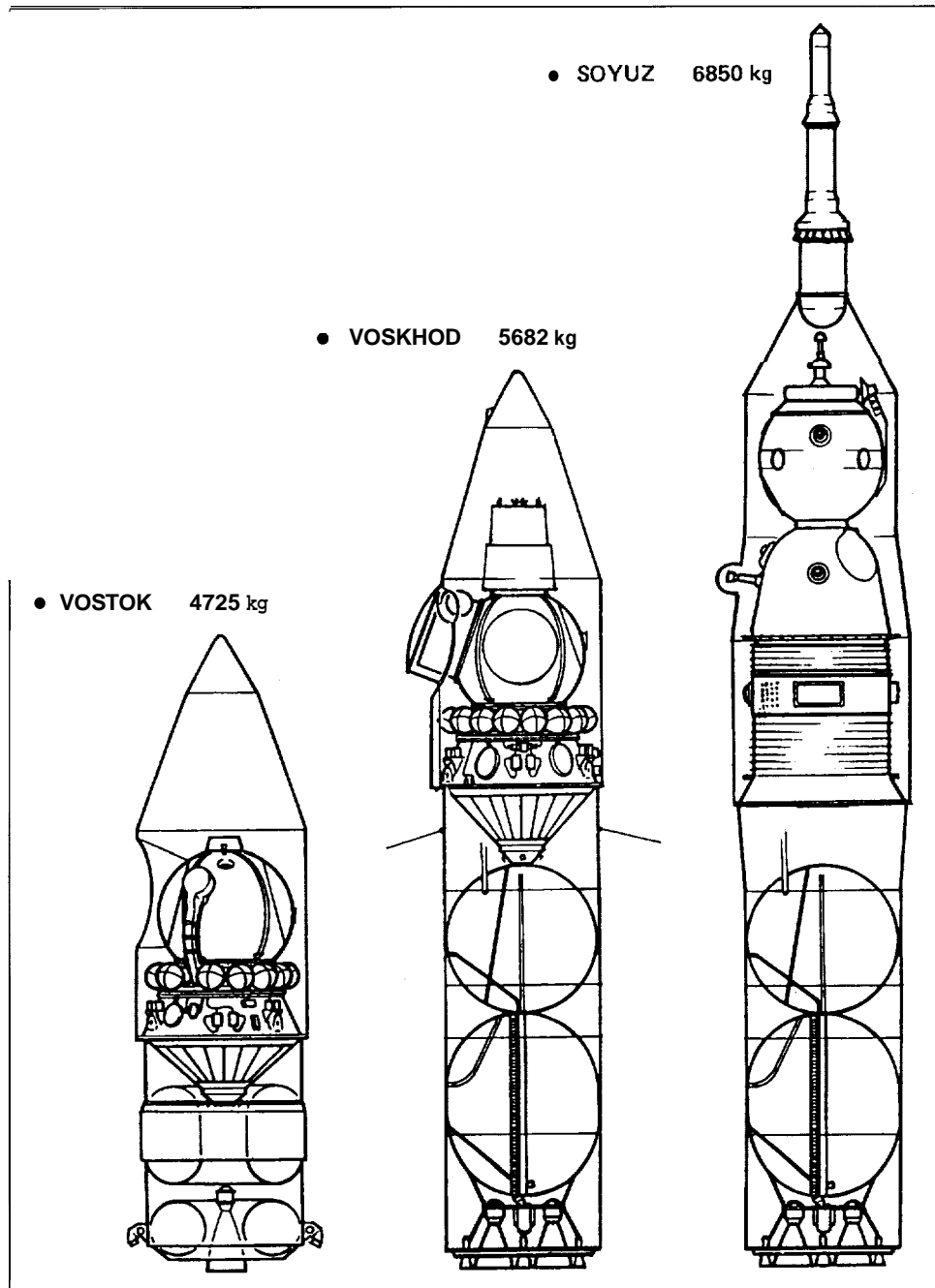

Here are the early generations of Soviet piloted Earth orbital spacecraft side by side. The Voskhod variant shown in the middle is the 3KD or spacewalk version. Almost identical versions of the R 7A core plus strap on would be below each of these payloads. The launch vehicles are the 8K72K for the Vostok, the 11A57 for the Voskhod and the 11A51U for the Soyuz. (copyright D R Woods)

CHALLENGE TO APOLLO

The module, apart from being an additional space for cosmonauts to sleep, rest, or conduct scientific experiments, also had an additional but very important role: to serve as an airlock for EVA operations when depressurized as "a buffer" between the descent apparatus and outer space."

The Soyuz development program, beginning with the 7K and leading up to the 7K-OK, lasted over half a decade. During that period, engineers made a number of evolutionary changes as a result of testing and research. For the first time in a Soviet piloted space project, the designers introduced a true launch escape system, much like the one used on NASA's Mercury spacecraft. The system consisted of a tower fixed on top of the Soyuz shroud with a set of nozzles for a single seventy-six-ton-thrust solid-propellant rocket engine. During the period from T-20 minutes up to T+160 seconds, in the case of a booster accident, the payload shroud would split into two, the descent apparatus and living compartment of the Soyuz would separate from the instrument-aggregate compartment, and the tower engine would fire to lift the stack away from the booster. Four grill-like petals would then open at the base of the shortened spacecraft to stabilize the vehicle during its trajectory. Three asymmetrical engines would ignite to guide the stack on a proper heading, following which the backup parachute would open. A crew could potentially expect to endure a load of up to ten g's in such a system, landing about three kilometers away from the pad in the case of a pad abort. Engineers completed the design of this system in 1964 at OKB-1 in cooperation with its Branch No. 3. The critical main solid-propellant engine was built by the Design Bureau No. 2 of the Moscow-based Plant No. 81, headed by Chief Designer Ivan I. Kartukov.⁹

The Soyuz and all its variants would use a modification of the 11A57 booster that had launched the Voskhod spacecraft during 1964-65. This "new" variant had essentially the same configuration—a basic R-7A missile topped off with an upper stage from Chief Designer Kosberg's OKB-154. The primary difference was the use of an updated engine for the third stage, the RD-0110 instead of the earlier RD-0108, thus increasing thrust from 30.0 tons to 30.4 tons. The new booster, known as the 11A511, was specifically developed for the Soyuz program, an extremely rare case of a Soviet launch vehicle developed first for "civilian" goals. With a Soyuz spacecraft, the length of the booster was 49.91 meters. Total launch thrust at sea level was 411.1 tons. The rocket, which was itself also called the Soyuz, could launch a 6,900-kilogram payload into a 200- by 450-kilometer orbit.

One of the most challenging tasks for designers at OKB-1 was developing on-board systems for the 7K-OK that were far superior to the ones used on Vostok. OKB-1's Department No. 27, under the leadership of Boris V. Raushenbakh, was responsible for designing the System of Orientation and Motion Control (SOUND), which allowed the craft to orient in orbit using both an inertial system and an orbital coordinate system, to carry out orbital maneuvers, to conduct rendezvous approach profiles, and to orient the solar panels to the Sun. The system consisted of four components:

- The attitude control sensors and the Vzor sighting device
- Gyroscopes and an "electronic computer"
- The *Igla* radar system for searching and homing other vehicles
- Attitude control engines

9. *Ibid.*, p. 169; Christian Lardier, *L'Astronautique Soviétique* (Paris: Armand Colin, 1992), pp. 180-82; G. S. Narimanov, ed., *Ot kosmicheskikh korably - k orbitalnykh stantsiyam* (Moscow: Mashinostroyeniye, 1971), pp. 23-29; Peter Smolders, *Soviets in Space* (New York: Taplinger Publishing Co., 1973), pp. 152-54; Kenneth Gatland, *Manned Spacecraft* (New York: Macmillan, 1976), pp. 260-61; A. Koroteyev, "From the History of Space Science. The Scientific-Research Institute of Jet Propulsion" (English title), *Aviatsiya i kosmonavtika* no. 6 (November-December 1993) 39-41.

10. Semenov, ed., *Raketno-Kosmicheskaya Korporatsiya*, p. 172-73; Lardier, *L'Astronautique Soviétique*, p. 182.

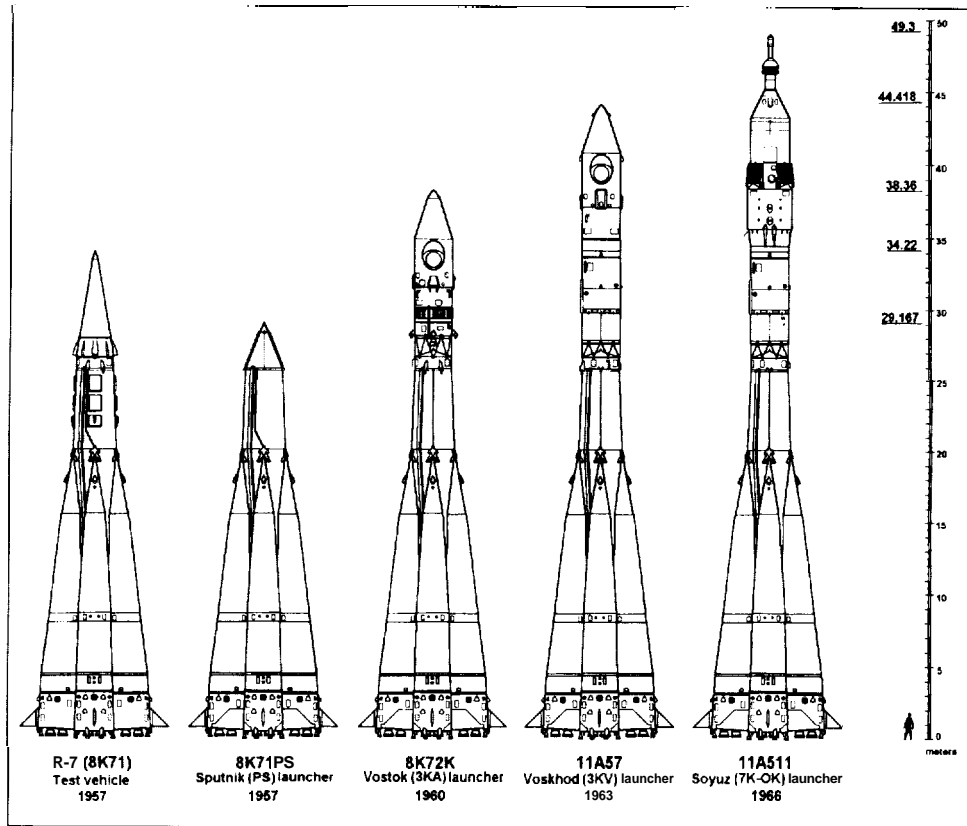

This shows the evolution of Soviet space launch vehicles in the early years. From the left are the R 7 ICBM, the Sputnik launcher, the Vostok launcher, the Voskhod launcher, and the Soyuz launcher (copyright Peter Gorin)

To face the solar arrays toward the Sun, the cosmonauts would roll the Soyuz using the attitude control thrusters until the Sun appeared in the cross hairs of the Vzor device below the main control panel. A second command would put the vehicle into rotation around the Sun-spacecraft axis, allowing direct continuous illumination of the panels. For orbital maneuvers, the cosmonauts would roll the ship until Earth appeared in the Vzor, activate a set of gyroscopes, and fire the main engine. For guidance, the engineers developed a three-step gyroscope system, two with two degrees of freedom each (for inertial orientation) and one with three degrees of freedom (a sensor for angular velocity). There were also devices for effecting orientation using infrared sensors relative to Earth's vertical, as well as stellar, solar, and ion sensors (for the velocity vector), all installed on the exterior of the instrument-aggregate compartment. Celestial orientation would be carried out by setting an optical sensor in such a position that the angle between the sensor and a solar sensor corresponded to the relative locations of the Sun and a given star.

The Igla radar system for measuring parameters relative to motion was developed by the Moscow-based NII-648 headed by Chief Designer Armen S. Mnatsakanyan. The primary elements of the system were two long antennas (short- and long-range transponders) attached on the exterior of the living compartment at a ninety-degree angle to each other, a rendezvous TV camera, a third antenna attached at the rear of the spacecraft to allow an approach from "reverse," and the *Stels* system for protecting the system from secondary radio interference. The

Igla system would automatically bring the spacecraft to a distance of only 200–300 meters relative to its target vehicle from a distance of hundreds of kilometers by continually measuring the relative velocities and distances between the two spacecraft and carrying out attitude control and main engine boosts. The cosmonauts would take over manual control from 200–300 meters. The complex approach algorithms and the great volume of data exchanged in guidance circuits during rendezvous necessitated extensive ground testing of the Igla and the SOUD as a whole in three-stage rotating stands named the Kardan and Platform, simulating a spacecraft's motion through space. Igla itself was tested in a nonecho radio chamber built by NII-648. Engineers eliminated at least ten major defects in the SOUD during testing in 1965–66.

As early as 1962, engineers had begun the development of a docking system for the Soyuz spacecraft. A team led by OKB-1 engineers Viktor P. Legostayev and Vladimir S. Syromiatnikov developed a "pin-cone" scheme, which allowed two spaceships, one with an active docking unit and one with a passive unit, to connect together. No provision was made for internal transfer because the original conception was for a circumlunar mission, with dockings with various tankers. In 1965, when the Soyuz program was redirected, Korolev proposed that the system be changed to allow for the internal transfer of crews, but because of the significant amount of work already done on the original system, as well as a lack of time, Korolev accepted designer Feoktistov's proposal to keep the original design. This system included a pin on the active vehicle that would be captured in the cone-like funnel of the passive vehicle, canceling any remaining velocity and angular displacement. The system required a significant degree of precision because the docking system included electrical umbilical connectors in the face of the docking ring to link the two spacecraft. These multiple prong and socket connectors were precisely aligned by using 152-millimeter- and twenty-five-millimeter-diameter guide pins. Once capture was made, an electric motor would retract the probe for final structural latching. Unlike the Apollo spacecraft, the system allowed repetitive dockings and undockings.

Given that originally the Soyuz was meant for circumlunar flight, the designers had created a long-range communications system for the spacecraft, which was later modified for Earth-orbit operations in 1964. The multifunctional long-range version was developed by NII-885, under Chief Designer Ryazanskiy of the Council of Chief Designers, and it included command radio links, television and telemetric channels, and voice communications. Later, these components were split up between different organizations. The Krechet TV system was designed by NII-380 at Leningrad under Chief Designer Igor A. Rosselevich, the same team that had developed the famous imaging system that first photographed the far side of the Moon in 1959. The radio-telemetry system for the 7K-OK Soyuz was created by Ryazanskiy's NII-885, while the Zarya voice communications system was the work of NII-695, led by Chief Designer Yuriy S. Bykov. Both had worked in the same capacity for Vostok. The telemetry system was composed of forty small T-shaped antennas around the aft end of the descent apparatus. The Zarya was a comprehensive ultra-shortwave and shortwave system ensuring communications in orbit, during reentry, and after landing. The *Mir-3* autonomous data recorders developed under Chief Designer Ivan I. Utkin at NII-88 rounded out the telemetry and communications systems on the Soyuz spacecraft.

Engineers developed the life support system for the 7K-OK using the experience on the Vostok and Voskhod vehicles. It included systems for maintaining internal atmosphere, ensuring a supply of water, food, and clothing, providing a means of waste collection, controlling medical indices, and providing an emergency kit for use in the case of an emergency landing. Like the earlier spacecraft, the Soyuz maintained normal atmospheric conditions at temperatures of twenty plus or minus three degrees Centigrade. Cabin pressure was set at 710 to 850 mm Hg and relative humidity at 40 to 55 percent. Temperature and humidity were controlled by a single-loop series of heat exchangers. The ratio of oxygen to carbon dioxide was ensured by a superoxide chemical, which released oxygen, and lithium hydroxide for absorbing

carbon dioxide. On-board sensors constantly measured the atmospheric conditions and adjusted them accordingly. OKB-124 developed the primary atmospheric regeneration systems. Plant No. 918 created the flight suits, water holders, emergency kits, and sewage disposal systems. The Institute of Biomedical Problems developed the food and medical instrumentation. The Analytical Instrument Building Special Design Bureau provided the gas analyzer for the atmosphere.

Engineers expended much effort on the development of a landing system. Despite Korolev's interest in exotic schemes, such as helicopter rotors, a more conservative parachute system was the frontrunner and was eventually adopted. Starting in 1961, OKB-1, in cooperation with the famous M. M. Gromov Flight-Research Institute, Plant No. 918, the Scientific-Research and Experimental Institute of the Parachute Landing Service, and Plant No. 81, carried out coordinated work on a parachute system leading to the development of a "bi-cascade" system with a solid-propellant braking engine at the base of the primary parachute, much like in the Voskhod spacecraft. The parachute-reactive system would reduce velocity down to eight and a half meters per second. In the case of engine failure, the velocity would be a barely tolerable ten meters per second. The backup system of parachutes would not employ any engine. Such a system was tested at the Flight-Research Institute beginning in 1962 in mass models of the 7K Soyuz. Subsequent modifications of the parachute-reactive system in 1963 and 1964 by Plant No. 918, however, revealed inconsistencies in the operation of the backup system, when used in conjunction with the primary parachute.

In late 1964 and early 1965, on orders from Deputy Chief Designer Bushuyev, engineers began a search to revamp the whole system. The engineers had two requirements: that the landing velocity with the primary system be reduced to at least six and a half meters per second, and that the braking engines be removed from the parachute and installed instead at the base of the descent apparatus. A reduction of velocity was achieved by increasing the dome size of the primary parachute from 574 to 1,000 square meters. In addition, Chief Designer Kartukov's Plant No. 81 developed a set of four small solid-propellant engines positioned at the bottom of the descent apparatus that would be exposed following the jettisoning of the outer thermal base. The engines were extremely compact and capable of operating after a lengthy stay in vacuum and even in conditions of soil blockage."

The landing sequence of the Soyuz 7K-OK was standard for all Soviet piloted missions for thirty years. At an altitude of nine and a half kilometers, the parachute system would go into operation by shooting off the parachute hatch and issuing a primary fourteen-square-meter drogue parachute, followed in seventeen seconds by the main parachute. Both would be compressed and folded in a container with a volume of only 0.3 cubic meter. Subsequently, the thermal shield would be discarded at three kilometers, and at about one and a half meters prior to touchdown, a gamma-ray altimeter would issue a command to fire the four solid-propellant motors at the base of the descent apparatus to reduce landing velocity to a final two to three meters per second. In the case of a main parachute system failure, a second hatch would fire off and deploy a drogue plus backup parachute combination, the latter with a dome area of 574 square meters. These two would be packed in a second container with a volume of 0.2 cubic meter. When using the smaller parachute, the landing would be rougher, but certainly survivable. A worst-case scenario, with the backup parachute and loss of soft-landing engines, would subject a crew to four- to nine-meter-per-second velocities at landing.

The parachutes were built by the Scientific-Research and Experimental Institute of the Parachute Landing Service, an aviation industry enterprise headed by Chief Designer Fedor

11 Semenov ed *Raketno Kosmicheskaya Korporatsiya* pp 170-77 Edward Clinton Ezell and Linda Neumann Ezell *The Partnership A History of the Apollo-Soyuz Test Project* (Washington DC NASA Special Publication (SP) 4209 1978) pp 116-17 Lardier *L'Astronautique Soviétique* pp 180-82 Narimanov *Ot kosmich eskrkh korablye* pp 21-54

D. Tkachev, who had also designed the Vostok and Voskhod parachutes. They were tested through the mid-1960s in various conditions, including sea landings and drops from An-12 aircraft from altitudes of ten kilometers. The aircraft drops consisted of seven tests in 1965 and 1966 at the Air Force's testing station at Feodosiya. It was during this time that engineers identified and eliminated problems with hydrogen peroxide leaks on the parachutes."

The 7K-OK was not the only variant of the Soyuz spacecraft developed in the mid-1960s. Given that the primary financier of the project would be the Ministry of Defense, Korolev proposed parallel variants in 1962 for exclusively military purposes. These were part of the Soyuz-P and Soyuz-R projects. The former was a piloted anti-satellite interceptor program, while the latter was a piloted reconnaissance station effort. In 1963, because of the workload at OKB-1, Korolev transferred further work on the two projects to his Branch No. 3 at Kuybyshev, whose primary area of work at that point was work on the Zenit-2 and Zenit-4 automated reconnaissance satellites and R-7 booster manufacturing. The head of the branch was Deputy Chief Designer Dmitriy I. Kozlov, one of Korolev's old proteges who had served as the "lead designer" of the R-7 ICBM during the 1950s.

The Soyuz-P used the 7K-PPK variant of the basic Soyuz craft. Few details on the vehicle have been declassified: Kozlov's engineers evidently designed a mission-unique launch vehicle, the 11A514, specifically for the project. The project was put on hold in mid-1964 and terminated in 1965, evidently because of the military's preference for *automated* anti-satellites, such as Chelomey's "IS" system, which had already flown two successful missions in 1963 and 1964.

The Soyuz-R consisted of two separate vehicles, a small space station named the 11F71 and a ferry craft, the 11F72 (or 7K-TK), to take crews there. The former was designed by using the instrument-aggregate compartment of the basic Soyuz craft as crew living quarters and substituting the remaining two modules with a single compartment housing equipment for electronic- and photo-reconnaissance. The 7K-TK ferry was similar to the basic Soyuz, but it included an internal hatch transfer system to allow cosmonauts to move from the ferry to the station without having to exit into space. On June 18, 1964, the USSR Ministry of Defense signed its five-year plan on space-based reconnaissance covering the years 1964-1969. The Soyuz-R complex was included as part of that plan, which also included several other programs, including Zenit (photo-reconnaissance), Morya-1 (ocean reconnaissance), and Spiral (military spaceplane)." Soon after, Kozlov's engineers prepared the predraft plan for the Soyuz-R, which was approved by the Interdepartmental Scientific-Technical Council for Space Research, the interministerial structure supervising space program proposals.

The Soyuz program as a whole was not guaranteed implementation despite OKB-1's signing off on a draft plan for the spacecraft as well as ministerial support. Sometime in 1965, the Soviet government may have even considered transferring the whole project to another design bureau. In a perhaps desperate move, Korolev ordered his subordinates to organize an exhibit on the Soyuz program for Communist Party and government officials to demonstrate that it would be a gross mistake to move the project to another enterprise. An engineer who participated in organizing the displays recalled Korolev's visit to evaluate the exhibit:

Our many years of work, said Sergey Paulovich [Korolev], may go for naught. The topic may be assigned to another enterprise, and the experience of our collective, which has

12. Serenov, ed., *Raketno-Kosmicheskaya Korporatsiya*, pp. 170-71

13. Konstantin Lantratov, "Dmitriy Kozlov's 'Zvezda'" (English title), *Novosti kosmonautiki* 3 (January 27-February 9, 1997) 50-55. Kozlov signed the predraft plan for the Soyuz-R complex on July 15, 1965

gone through such a difficult path. will remain unused. Korolev spoke quietly and thoughtfully. We all understood that this was very difficult for him. It was painful to see this willful, fearless man suppressed by such circumstances. But he was able to control his feelings and concluded his conversation on an upbeat note: we will fight and defend our brainchild.¹⁴

Defend it they did, and the Soyuz program remained behind at OKB-1. On August 18, 1965, the Military-Industrial Commission signed decree no. 180 titled "On the Order of Work on the 'Soyuz' Complex," which for the first time approved a schedule for the execution of the project, thus legitimizing the new, redirected Soyuz. Final air and sea testing of the descent apparatus was set for the third and fourth quarters of 1965, while the beginning of flight tests in Earth orbit for automated versions was scheduled for the first quarter of 1966. In total, seven Soyuz 7K-OK spacecraft were approved for manufacture by the second quarter of 1966."

The redirection of the Soyuz program in 1964 and 1965 laid the basis for the most prolific Soviet piloted spacecraft in its history. In 1965, the 7K-OK Earth-orbital Soyuz was, however, only one of three thematic directions of research at OKB-1. The other two were aimed at the exploration of the Moon in competition with the United States. In the interconnected world of Soviet space politics, by a fortuitous set of circumstances, designers would use the Soyuz spaceship as a starting point to develop vehicles for both Moon programs.

From EOR to LOR

From 1961 to mid-1964, all conceptions of possible piloted lunar landings studied by Soviet engineers used the Earth-orbit rendezvous (EOR) mission profile, whereby a lunar spacecraft would be assembled in Earth's orbit through multiple launches of the NI. This spacecraft complex would then fire itself toward the Moon to carry out its designated mission. In 1963 and 1964, at a time when the lunar landing began to eclipse a circumlunar flight as a primary objective of the Soviet piloted space program. OKB-1 designers considered a quadruple launch scheme. The plan involved launching three NIs into Earth orbit—that is, assembling a 200-ton behemoth spacecraft in Earth orbit. The crew would fly into orbit on a fourth rocket, a standard Soyuz launcher such as the 11A511." Despite the high costs and multiple dockings, the increased payload afforded a sufficient margin to build large spacecraft equipped with redundant systems to ensure the safety of the crew and spacecraft systems.

All this changed with the August 1964 decree in support of a Soviet lunar landing program. It was at that point that OKB-1 decided to effectively shift the focus from an EOR profile to a sin-

¹⁴ A. Yu. Ishlinskiy, ed., *Akademik S. P. Korolev ucheniy, mrhener, chelovek* (Moscow: Nauka, 1986), pp. 337-38. The identity of the other design bureau is not known. One unconfirmed source suggests that the Soyuz program was to have been transferred to Chelomey's OKB-52 so that OKB-1 could focus exclusively on the NI program. See Lardier, *L'Astronautique Soviétique*, p. 158.

¹⁵ I. A. Marinin, "The First Civilian Cosmonauts" (English title). *Novosti kosmonautiki* 12-13 (June 3-30, 1996) 81-87. The manufacturing schedule was two ships by the fourth quarter of 1965, two by the first quarter of 1966, and three by the second quarter of 1966. See Kamanin, *Skrytiy kosmos: 1964-1966*, p. 220.

¹⁶ For alternative proposals, such as a double-launch scheme, see I. B. Afanasyev, "Unknown Spacecraft (From the History of the Soviet Space Program)" (English title). *Novoye v zhizni Nauke, tekhnike Seriya kosmonautika*, astronomiya no. 12 (December 1991): 1-64. For different triple-launch schemes, see I. A. Marinin and S. Kh. Shamsutdinov, "Soviet Programs for Piloted Flight to the Moon" (English title), *Zemlya i vseleennaya* no. 5 (September-October 1993) 77-85; N. Kamanin, "A Coal Worth Working for: The Space Diaries of a General" (English title), *Vozdushniy transport* 43 (1993). See also Yu. A. Mozzhorin, et al., eds, *Dorogr v kosmos II* (Moscow: MAI, 1992), p. 59; V. P. Mishin, "Why Didn't We Fly to the Moon?" (English title), *Znanrye tekhnike: seriya kosmonavtika, astronomiya* no. 12 (December 1990), 3-43.

gle-launch lunar-orbit rendezvous (LOR) profile, identical to the one adopted for Apollo. Despite the historical importance of the decision, the reasons for this abrupt shift still remain obscure. Korolev's First Deputy Mishin recalled years later: "The American program nudged our country's highest leaders into issuing the assignment for the development of designs for launch vehicles that could support a lunar mission with a *single* launch."¹⁷ Another engineer at OKB-I attributes the switch to the single-launch idea to Mishin himself. Others say it was Korolev.¹⁸ There were probably two motivations behind the shift in strategy. There may have been pressure from the industrial leaders of the space program to adopt a mission profile similar to the American one. This sort of "parallel" response was chronically evident in weapons systems development. While less common in the space program, there was precedent throughout the history of the Soviet space program for technical decisions driven by mirroring American technical choices. A second motivation was most likely simple economics. One rocket would cost less than the two or three required for EOR, and cost was certainly a big factor in the NI program.

The decision to move with a single-launch profile came hand in hand with the adoption of LOR for the lunar landing mission; a direct ascent plan, the third option, was out of the reach of the NI booster's capability. The LOR profile had originally been proposed as early as 1929 by a Russian contemporary of Tsiolkovskiy named Yuriy V. Kondratyuk.¹⁹ Korolev, Glushko, and others were, in fact, intimately familiar with the approach even before the Apollo selection. although its adoption in the NI-L3 program raised a Pandora's box of problems that plagued the project throughout its existence.

The NI design of mid-1964 had a lifting capability of approximately seventy-five tons. All calculations had conclusively proven that this figure was simply not enough to comprise a TLI stage, a lunar orbiting module with one pilot, and a lunar landing vehicle with two cosmonauts. By comparison, the payload in Earth orbit projected for NASA's Saturn V was close to 130 tons. Korolev evidently promised the space industry leaders at the time that he would be capable of carrying out a single launch for a lunar landing by two means: decreasing the mass of the payload and increasing the effective carrying capacity of the NI. For Korolev, both roads became "maniacal" obsessions as, through the end of 1964 and the first part of 1965, engineers explored every avenue to shave off kilograms, even grams, from the L3 stack that would go to the Moon. One engineer working on the lunar lander recalled:

At the time, the developers were racking their brains about how to keep within the rigid framework of the initially adopted energy capabilities of the launcher. The search went out in all directions. For each saved or "found" kilogram of mass, the Chief Designer paid a bonus of 50-60 rubles. To us young engineers, that was a lot of money.²⁰

There was even an apocryphal story that one engineer had managed to get a bonus for proposing to suck out all the air from the tubular design of the rocket, because even air had mass. All proposals, no matter how outlandish, were given consideration. But the gains proved to be incremental. Korolev, in frustration, told his Deputy Chertok. "I don't need your ten kilograms. I need a ton."²¹

17. Mishin, "Why Didn't We Fly to the Moon?" Author's emphasis.

18. For Mishin, see Peter Smolders, "It Made Sense to Build a Space Station," *Spaceflight* 38 (April 1996): 113-15. For Korolev, see Mozzhorin, et al., eds., *Dorogr v kosmos. II*, p. 59.

19. Golovanov, *Korolev*, p. 757.

20. V. Filin, "At the Request of the Reader: The NI-L3 Project" (English title), *Aviatsiya i kosmonautika* no 12 (December 1991): 44-45.

21. Golovanov, *Korolev*, pp. 757-58.

The first approach was to incrementally raise the payload of the rocket. Korolev asked his designers to improve the lifting capabilities of the N1, first from seventy-five tons to eighty-five tons, and then finally to ninety-five to 100 tons. Studies at the design bureau had in fact shown that ninety-five to 100 tons would be the absolute minimum to achieve a lunar landing mission." Engineers under Deputy Chief Designer Kryukov altered the original N1 design in six fundamental ways to increase the N1 payload:

- Increase the number of engines on the first stage from twenty-four to thirty
- Lower the altitude of the orbit around Earth prior to lunar boost from 300 to 220 kilometers
- Shift the launch azimuth further to the south to a more favorable 51.6 degrees
- Increase the propellant load for the booster by having cylindrical inserts in the equatorial part of the tanks and lowering the fuel and oxidizer temperatures
- Install four latticed stabilizers at the tail of the Blok A first stage
- Increase the thrust of the engines on the first three stages by an average of 2 percent by introducing a "flexible" program for controlling engine thrust"

With these changes, especially the addition of six new engines to the first stage, the N1's total launch mass increased from 2,200 tons to 2,750 tons. Payload capability would theoretically increase to ninety-two to ninety-five tons, just barely enough for its slated mission.

Korolev signed the predraft plan for the updated N1 booster and its L3 lunar stack, specifying the new requirements of the mission—single launch, increased payload mass, and LOR—on December 25, 1964.²² The document contained "initial data for the development of working documentation" for the L3 complex." While the N1 consisted of three stages called Blok A, Blok B, and Blok V, the L3 comprised the following:

- Blok C (the fourth stage, for translunar injection)
- Blok D (the fifth stage, for lunar-orbit insertion and lunar descent)
- The Lunar Orbital Ship or LOK (the "mother ship")
- The Lunar Ship or LK (the "lunar lander")

In the interest of conserving mass, OKB-1 decided to dispense with the idea of a three-person crew like on Apollo, reducing the total crew size to only two. One cosmonaut would stay in orbit in the LOK, while the other would land on the Moon in the LK. The risks in the plan increased almost day by day as the plan was continuously revised.

This whole effort to optimize the capabilities of the N1, and the N1-13 program as a whole, was the source of much discord within OKB-1—an unusual situation for a design bureau that had displayed a united front on all previous space projects. Ilya V. Lavrov, one of Korolev's best

22. R. Dolgopyatov, B. Dorofeyev, and S. Kryukov. "At the Readers' Request: The N1 Project" (English title), *Aviatsiya i kosmonautika* no. 9 (September 1992): 34–37.

23. Mishin. "Why Didn't We Fly to the Moon?". Dolgopyatov, Dorofeyev, and Kryukov. "At the Readers' Request: The N1 Project". Boris Arkadyevich Dorofeyev. "History of the Development of the N1-L3 Moon Program." presented at the 10th International Symposium on the History of Astronautics and Aeronautics, Moscow State University, Moscow, Russia, June 20–27, 1995. Semenov, ed. *Raketno-Kosmicheskaya Korporatsiya* p. 255 Fuel temperature was reduced to minus fifteen to minus twenty degrees Centigrade, while oxidizer temperature was reduced to -191 degrees Centigrade. There were also additional structural changes made to later N1 boosters to increase lifting mass.

24. Afanasyev. "Unknown Spacecraft", Igor Afanasyev, "N1: Absolutely Secret. Part II" (English title) *Krylya rodiny* no. 10 (October 1993): 1–4; Semenov, ed. *Raketno-Kosmicheskaya Korporatsiya*, p. 636. Another source notes that OKB-1 and OKB-586 jointly finished the N1-L3 predraft plan on December 30, 1964. See B. V. Raushenbakh, ed. *S. P. Korolev i ego delo: suet i teni v istorii Kosmonautiki* (Moscow: Nauka, 1998), p. 628.

25. Semenov, ed. *Raketno-Kosmicheskaya Korporatsiya*, p. 254.

engineers, at the time working on Mars spacecraft, recalled that the L3 program "was on the brink of fantasy."²⁶ Another engineer, Gleb Yu. Maksimov, one of the pioneers of Soviet space technology who had participated in the earliest landmark studies on artificial satellites in the 1950s, wrote a personal letter to Korolev in August 1964, imploring Korolev not to go ahead with the L3 single-launch approach. Maksimov, who had led the design teams for automated lunar probes and piloted Martian spaceships, was reassigned, on Korolev's orders, away from the central branch so that the autocratic Korolev would not have to deal with his criticisms. Feoktistov, the engineer behind the Vostok spacecraft, also disagreed with Korolev:

From the beginning I rejected this project because the parameters of the N1 were not right. . . . The flight to the Moon did not appeal to me very much, because the N1 could not place more than 90 tons in low Earth orbit . . . 90 tons was not enough: the Americans had calculated 120 tons in low Earth orbit and we were building everything heavier than the Americans. So I was not in favour of our approach and we constantly had conflicts about it."

The conflict over the N1-L3 plan prompted Korolev to request the formation of an "expert commission." under Academy of Sciences President Keldysh, to examine the technical pros and cons of the project. But Korolev had resistance even from the outside. Yuriy A. Mozzhorin, the director of the space policy advisory NII-88, came out against the single-launch scheme at a meeting of the commission in July 1965. Keldysh for the first time also sided against Korolev. The usually imperturbable scientist was furious: "What kind of nerve must we have to disembark one man on the Moon?! . . . Imagine for a minute being alone on the Moon! That's a straight road to the psychiatric hospital."²⁸ Psychological considerations aside, Keldysh's objections were in fact based on more concrete concerns: he believed that the whole program had evolved by pushing systems to the extreme—that is, there were no reserves at all, a sure road to failure.

Perhaps the biggest casualty of the N1-L3 project was OKB-1 Deputy Chief Designer Leonid A. Voskresenskiy. One of Korolev's most beloved deputies, he was also certainly the most colorful. He had been born to the family of a priest and therefore was penalized later by the Communist Party, which prevented him from getting a higher education. Perhaps the only deputy of Korolev without a college education, Voskresenskiy had an intuition about testing rockets that outshone many of his more scholarly colleagues, whom he dismissed as "men burdened by higher education." His utter fearlessness in the face of danger characterized not only his work with rockets, but also his passion for riding fast cars and motorcycles—a hobby that landed him in the hospital on occasion. One associate described him as "a baron with aristocratic manners. On the other hand, he came across as a peasant full of crude jokes. Paunchy, unsmiling, and wearing a tie, he made a majestic impression, and he was clearly well-respected."²⁹ Voskresenskiy was appointed a Deputy Chief Designer in October 1953 and oversaw flight and ground testing of every single missile and spacecraft from the days of the A-4 up to the Vostok and R-9 launches during the early 1960s.

By 1963, perhaps as a result of his misadventures, Voskresenskiy's health was seriously failing. He gave up his coveted role as director of flight testing at Tyura-Tam, preferring to work indoors. Despite a serious heart attack in early 1964, Voskresenskiy was closely involved in

26 Golovanov *Korolev* p 758

27 Smolders "It Made Sense to Build a Space Station" p 114

28 Golovanov *Korolev* p 758

29 Yu A Mozzhorin *et al* eds *Nachalo kosmicheskoy ery vospominaniya veteranov raketno kosmicheskoy tekhniki i kosmonavtiki uypusk utroy* (Moscow RNITsKD 1994) p 46 Yu A Mozzhorin *et al* eds *Dorogi v kosmos I* (Moscow MAI 1992) pp 83-84

work on the NI, especially in the preparation of its draft plan. When work on the giant launch complexes for the NI began at Tyura-Tam the same year, Voskresenskiy was of the opinion that OKB-1 needed to fund the construction of a full-sized test stand for the first stage despite the delay it might cause. Korolev was enraged at Voskresenskiy's tone, perhaps precisely because he knew that Voskresenskiy was right. One engineer recalled an altercation between the two over the issue in 1963:

Korolev came up to Voskresenskiy, walked around him, raised his fist to the latter's face and said between clenched teeth: "You should be beaten with a stick for what you did! With a stick. . . a stick . . . a stick!" Korolev was punctuating every word with his fist. I had not seen the Chief Designer in such a state of anger for a long time. But Voskresenskiy parried with his words: "I'm fifty years old, this is not the time to be threatening me with a stick." After a short pause, Korolev stepped up to him, embraced him and said, "Sorry Leonid. No offense intended. I was overreacting."³⁰

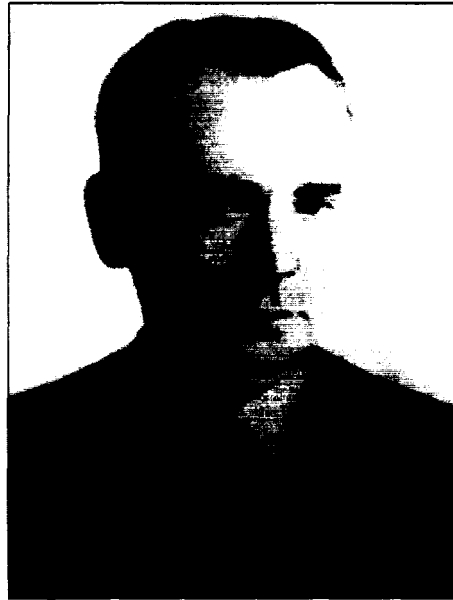

Leonid Voskresenskiy was the person responsible for flight-testing all missiles and spacecraft at OKB 1 from the 1940s on. He led the launch teams for both the first Sputnik and Vostok launches and was perhaps the most well loved of all of Korolev's deputies. (files of Peter Gorin)

When Khrushchev released the first 500 million rubles for the NI program, it was Voskresenskiy who stated that OKB-1 would need ten times more to achieve the goals set forth in the program. Korolev merely replied that if they asked the government for such enormous amounts of money, the project would be terminated."

Voskresenskiy eventually refused to sign a single document related to the NI until Korolev agreed to a test stand. The stalemate came to an end when Voskresenskiy offered his resignation from OKB-1 in 1964. Korolev accepted. It was an enormous loss to the fortunes of the design bureau. Voskresenskiy stayed on as a consultant to Korolev, participating in operations at the new space-launching base at Mirnyy, but he was no longer involved with the NI-L3 project. Just a year later, on December 14, 1965, he had returned from a concert with his wife when he collapsed and died from a brain hemorrhage at dinner. The fifty-two-year-old legend was buried with honors at the Novodevichiy Cemetery in Moscow. Korolev, who openly cried at the funeral, in his eulogy said, "Leonid, you were the first to open this road [to space]."³¹ In typical fashion, in his obituary, the Soviet press described Voskresenskiy only as "a scholar in the field of the elaboration and testing models of new machinery."³²

The objections from Voskresenskiy, Keldysh, Lavrov, Maksimov, Mozzhorin, Feoktistov, and others notwithstanding, Korolev bulldozed his own version of the NI-L3 project through

30. Mozzhorin, et al., eds., *Nachalo kosmicheskoy ery*, p. 48.

31. S. Leskov, *Kak my ne stetali na lunu* (Moscow: Panorama, 1991), pp. 21-22.

32. Mozzhorin, et al., eds., *Dorogi v kosmos: I*, p. 84; Colovanov, *Korolev*, p. 760.

33. "L. A. Voskresenskiy" (English title), *Izvestiya*, December 18, 1965, p. 6.

the members of the "expert commission" in 1965. The commission was a temporary body probably related to the Interdepartmental Scientific-Technical Council on Space Research, also headed by Keldysh, which had been created in 1958 to serve as an advisory body to recommend particular space projects to the government. Composed of various high representatives of the Ministry of General Machine Building, the Strategic Missile Forces, the Air Force, the design bureaus, and the Academy of Sciences, the council was supposed to prevent a single faction from pushing a program without oversight by other branches. It was not uncommon, however, for the important chief designers to "recruit" important allies on the council to support their position~.'~

On February 10, 1965, the Keldysh Commission, no doubt crumbling under Korolev's headstrong opinions, capitulated and formally approved Korolev's predraft plan for the creation of the L3 lunar system. According to the signed document, OKB-1 and its subcontractors were to come to an agreement on the technical goals for developing the primary systems by the end of the month and finish the final draft plan for the L3 lunar complex by August 1965. If all went according to plan, flight testing of the N1-L3 complex would begin in late 1966." Predictably, delays crept into the schedule, and throughout 1965, OKB-1 engineers, led by the so-called "high guard"—Mishin, Bushuyev, Chertok, Kryukov, and Okhapkin—directed an intensive revision process to fit the N1 into the stringent conditions set by the preliminary requirements. By late 1965, the draft plan had still not been finished, and the designers were still engaged in heated debates on the virtues of particular technical choices, some even arguing at this late stage if one booster was sufficient. By early September 1965, engineers had pushed the payload up to ninety-one and a half tons. On October 23, Kryukov presented his ideas on changing the inclination and other structural redesigns to increase mass to ninety-three tons. At the same time, Chertok was engaged in cutting systems from the lunar orbiter.

Apart from the internal dissent at OKB-1, Korolev's N1-L3 also had more organized opposition. Despite any formal involvement in the project, Glushko's plans continued to pose a threat to the project. In 1962, Glushko had begun the development of a new powerful engine, designated the RD-270, with a sea level thrust of 640 tons, more than four times more powerful than the modest NK-15s slated for use on the first stage of the N1.³⁴ It was powered by unsymmetrical dimethyl hydrazine and nitrogen tetroxide, the combination that Korolev called "devil's venom." The new engine was quite possibly the most powerful storable propellant engine ever built and had unusually high chamber pressures. By 1965, still supporting his stand on storable propellants, Glushko evidently proposed that the N1 be completely redesigned to use the RD-270 engine instead of the NK-15. His argument was that a smaller number of RD-270s could achieve the same performance as the thirty NK-15s, thus bypassing the complex problems associated with synchronizing thirty engines."

34. Descriptions of the organizational underpinnings of the Interdepartment Scientific-Technical Council on Space Research and its associated *ad hoc* commissions are still rare. One source describes an N1 commission in the early 1960s to determine the adequacy of seventy tons [sic] for a piloted lunar mission. This commission had four subcommittees, headed by Chief Designers N. A. Pilyugin (NII-885), V. I. Kuznetsov (NII-944), V. P. Barmin (GSKB SpetsMash), and Colonel A. S. Kalashnikov (Chief of the Third Directorate in GURVO in the Strategic Missile Forces). See Mikhail Rebrov, "The Secrets of Rocket Codes" (English title), *Krasnaya zvezda*, June 3, 1995, p. 6.

35. Other deadlines set in the document were, to finish the working documentation for manufacture between April and June 1965; to begin the manufacturing of experimental units, systems, and samples of the rocket (technological-model samples) in the first quarter of 1966 and (the first flight sample) in the fourth quarter of 1966, and to finish *experimental* work on the aggregates and blocks by 1966. See Semenov, ed., *Raketno-Kosmicheskaya Korporatsiya*, p. 254.

36. Dietrich Haeseler, "Soviet Rocket Motors on View," *Spaceflight* 35 (February 1993), 40-41.

37. The "number of engines" argument between Korolev and Glushko is summarized in Sergey Leskov, "How We Didn't fly to the Moon" (English title), *Izvestiya*, August 18, 1989, p. 3; Mozzhorin, et al., eds., *Dorogi v kosmos I*, pp. 30-31.

In three years of development. Clushko's design bureau had not achieved any significant progress with the engine, but in 1965. Clushko mounted an unprecedented lobbying effort in support of the engine. He enlisted the support of Ustinov and newly appointed Minister of General Machine Building Sergey A. Afanasyev, two of the most powerful leaders of the space program. Afanasyev evidently supported exploring a redesign of the NI with the use of Clushko's engines. This was a full three years after the commencement of work on the NI, when the manufacturing of booster portions had already begun at plants all over the Soviet Union. It was the apotheosis of organizational and managerial chaos inherent in the lunar programs. Clushko himself attacked the NI with "unrelenting fervor," eventually "securing the support of every chief designer in a letter to the Central Committee of the Communist Party, blaming Korolev for every imaginable shortcoming."³⁸ Korolev, hurt by the abrupt changing of alliances among his old comrades-in-arms, such as Barmin, found himself with his back to the wall. The absurd proposal to redesign the NI eventually came to naught. A formal recommendation from NII-88 Director Mozzhorin may have finally convinced Afanasyev that it was an option not worth pursuing."

The NI retained its old engines, but the RD-270 development program was not by any means over. Instead, once again Clushko found an ally in General Designer Chelomey. It was an eerie repeat of the events of 1961-62 when Clushko had offered another engine for the NI, the RD-253, which had been refused by Korolev and eventually used on a Chelomey booster. What made the more recent challenge particularly ominous for Korolev was that this time Chelomey and Clushko vigorously supported a competitive proposal for landing a Soviet cosmonaut on the Moon. In the final days of Khrushchev's reign. Chelomey had first emerged with his UR-700 booster plan for competing with NI-L3. Khrushchev had given an order to make an informed and technical comparison between the two projects. Despite Khrushchev's ouster, this order hung over the fates of both efforts, threatening to either destroy Korolev's hard-earned gains or put a cap on Chelomey's ambitions—two outcomes that were mutually exclusive.

On October 20, 1965. Minister Afanasyev, a growing supporter of Chelomey's plans, issued an official order allowing Chelomey to draw up a formal draft plan in support of the UR-700. The proposal was supported not only by Clushko, but also by two of Korolev's oldest friends. Chief Designers Viktor I. Kuznetsov and Vladimir P. Barmin.⁴⁰ Both their "defections" were paramount to treason in Korolev's eyes because both were significant participants in the NI-L3 project. Kuznetsov, head of NII-944, was developing guidance systems for both the NI and the L3, while Barmin's CSKB SpetsMash was responsible for the design and construction of the giant launch complexes for the NI at Tyura-Tam. Barmin evidently believed that the two pads for the NI could be redesigned with minimal structural readjustments for Chelomey's UR-700. Georgiy S. Vetrov, the official historian of Korolev's design bureau, later called the RD-270 program "a useless initiative." adding:

Its development was supported by D. F. Ustinov and led to wasting a lot of time and resources. There was a scientific consensus that this engine would not be usable. In spite of this, a new project was started based on it—the heavy carrier UR-700. This diverted attention from the Ni heavy carrier project meant to carry out promising space and military programs."

38 Rebrov "The Secrets of Rocket Codes "

39 Georgiy Stepanovich Vetrov "Development of Heavy Launch Vehicles in the USSR " presented at the 10th International Symposium on the History of Astronautics and Aeronautics Clushko also evidently attempted to elicit Korolev's interest in engines using more exotic propellants There is an account of a visit by Korolev to Clushko's ground static stands at Primorsk to inspect the testing of a fluorine oxidizer-based engine in 1964 See Golovanov *Korolev* pp 711-12 Clushko also developed the RD-502 engine which used highly concentrated hydrogen peroxide (oxidizer) and pentaborane (fuel) in 1960-66

40 Interview Georgiy Stepanovich Vetrov with the author November 15 1996

41 C. Vetrov "The Difficult Fate of the NI Rocket" (English title) *Nauka i zhizn* no 5 (May 1994) 20-27

In "a desperate attempt to stop the dispersal of funds" to the UR-700. Korolev prepared a number of letters to Afanasyev. One letter dated September 29, 1965, co-signed by OKB-1 Deputy Chief Designers Mishin, Bushuyev, Kryukov, and Melnikov, was a virtual testament to Korolev's belief in the use of high-energy propellants during the future Soviet space program.⁴² In a second letter from early November 1965, prepared but apparently never sent, Korolev referred to the decision in 1962 to move ahead with the liquid oxygen (LOX) and kerosene combination, arguing that the future lay in liquid hydrogen and LOX combinations, only a step away from LOX-kerosene. He also engaged in a vitriolic attack on Glushko's design bureau:

One cannot but mention that for a number of years, the OKB-456 . . . ceased to work effectively on development of realistic engines which could be used for practical purposes. The OKB is completely isolated from the demands of life and spends its "activities" in unneeded developments, spending tremendous sums of money for that. All this is at a time when there is an acute need for good engines.⁴³

There was also an acute need for money. At the very moment when the NI-L3 project required the most investment into fixed resources, such as ground testing stations, launch complexes, transport systems, and manufacturing jigs, the abrupt support for the UR-700 seems to have had a deleterious effect on Korolev's dream. Mozzhorin recalled later:

Work on the NI project in 1964-1966 was carried out under difficult conditions. Production capacities were inadequate: plans called for the fabrication of four NI rockets in a year's time, but only one and a half were constructed. There were delays in the timetable. Delivery of completed units was stalled. There were difficulties in solving the problem of constructing the necessary stands and experimental installations. The Chief Designers allowed serious deviations from the requirements for the final ground tests: "Too long and costly," they said. "We'll debug it in flight."⁴⁴

Marshal Malinovskiy, the USSR Minister of Defense, told Air Force officials during a meeting in January 1965. "We cannot afford to and will not build super powerful space carriers and make flights to the Moon. Let the Academy of Sciences do all that." Mishin recalls that "construction of the production base [for the NI] was delayed two years."⁴⁵ Compared to the Saturn V project, the NI was a disaster waiting to happen. There were the inevitable accusations that the NI's capabilities were markedly inferior to those of the Saturn V. Korolev tried his best to respond. For example, in a memorandum dated May 29, 1965, he put his persuasive capabilities to work with new Minister Afanasyev, making the outlandish claim that the performance differences between the two vehicles were "insignificant," despite the fact that the NI weighed 20 to 40 percent more than its American counterpart.⁴⁷ Through all the setbacks and problems, Korolev remained surprisingly optimistic. During a conversation with an Air Force officer on

42. P. Korolev, V. P. Mishin, S. Kryukov, K. D. Bushuyev, and M. V. Melnikov, "On the Inexpediency of Development of the AT-NDMC Engine" (English title), *Nauka i zhizn* no. 5 (May 1994): 27-28.

43. James Harford, Korolev: How One Man Masterminded the Soviet Drive to Beat America to the Moon (New York: John Wiley & Sons, 1997), p. 273.

44. M. Rebrov, "But Things Were Like That—Top Secret: The Painful Fortune of the NI Project" (English title), *Krasnaya Zvezda*, January 13, 1990, p. 4.

45. N. Kamanin, "A Goal Worth Working for: General Kamanin's Space Diaries" (English title), *Vozdushniy transport* 44 (1993): 8-9.

46. A. Tarasov, "Missions in Dreams and Reality" (English title), *Pravda*, October 20, 1989, p. 4.

47. Harford, Korolev, p. 266.

September 1, the latter recalled, "[Korolev] told me with visible satisfaction about the state of the N1 rocket. It was his baby, and it should be ready in metal by the end of 1965."⁴⁸

The testing program for the N1 greatly depended on the fate of the CR-1 orbital bombardment system, because the former used modified versions of engines used on the latter. To add to the almost incomprehensible level of problems with the N1, the GR-1 came under severe attack in January 1965. The thinking from the Soviet leadership was not without good reason. The Soviet government had already invested in Yangel's R-36-0 orbital bombardment system, later designated the Fractional Orbital Bombardment System (FOBS) by Western observers. There was simply little reason to proceed with Korolev's CR-1, especially because the R-36 ICBM, in its basic missile version, had already flown several successful test flights from Tyuratam. All activity related to the CR-1, meanwhile, was limited to work in the plants. There were also serious delays in developing the NK-9 engines for the first stage, which did not bode well given that similar engines were set to be used on the first stage of the N1. Ustinov and Afanasyev terminated the GR-1 project sometime in mid-1965, although Korolev was not easily convinced and evidently tried to continue manufacturing some elements. In early August, Deputy Minister of General Machine Building Gleb M. Tabakov expressly forbid the OKB-1 plant from continuing the construction of the missile's second stage. Later in the month, Korolev made an aborted attempt at getting Ustinov interested in a space launch vehicle version of the GR-1, designated the 8K513, for orbiting military satellites. It was, however, too little too late. The project was permanently terminated.⁴⁹ Vetrov recalled later:

[The CR-1's] engines were similar to the N1 engines. Many N1 problems would have been solved beforehand, if the [CR-1] had been tested. It was ready for test flights, but Korolev was not allowed to launch it. Why? Apparently, somebody was afraid it would have been a success.⁵⁰

The missile was later called the "Intercontinental Missile From Moscow to Leningrad." because that was about how far it had traveled—from one plant to another. Although it was never flown, full-size models of the CR-1 were displayed with much fanfare at Moscow parades celebrating the Great October Revolution.

The loss of the CR-1 was a severe blow to the N1 program. Its death knell effectively meant that all elements of the N1 would have to be tested in flight without any prior research and development tests on smaller vehicles. Originally, the N1 project had included smaller versions of the giant booster designated the N11 and the N111 for exactly this purpose. But with the delays in work on the base N1, work on the other two variants progressively moved into the background. Throughout 1965, after the CR-1's demise, Korolev continued to desperately push the N11 booster, a launch vehicle using the second, third, and fourth stages of the N1, as the only means to ensure a rational development program for the N1. On September 28, 1965, Korolev signed internal documents in support of developing the N11, in addition to the development of nuclear rocket engines for future boosters, but as the months passed by, it was increasingly clear that the Ministry of General Machine Building was not interested. As Korolev discovered painfully throughout 1965, the glory days of blank checks from the late 1950s were over. The Soviet piloted space program was in the midst of acrimony and fragmentation unimaginable during the Sputnik days. By comparison, the work on Apollo and Saturn V was

48 L. N. Kamanin "In the Future His Name Will Probably Be" (English title) *Ogonek* 7 (February 9-16 1991) 28-31

49 The 8K513 is mentioned in Semenov, ed. *Raketno Kosmicheskaya Korporatsiya* pp. 129-30. See also I. Afanasyev "The Mysterious Nine" (English title) *Aviatsiya i kosmonavtika* no. 8 (August 1992) 34-35

50 Vetrov "Development of Heavy Launch Vehicles in the USSR"

CHALLENGE TO APOLLO

virtually a designer's dream. There were, of course, technical and managerial problems in NASA's development of the Apollo-Saturn system, but the chronic waste and infighting that characterized the Soviet lunar program at the time was of a remarkable level. It is surprising that engineers managed to get anything done at all.

At the same time, the Western perception of the Soviet space program was one of deliberate and sustained progress. NASA Administrator James E. Webb, in testimony before the Senate Space Committee on March 8, 1965, told his audience:

We do not know whether they have selected some specific goal, such as a lunar landing, or even a duplication of our *Apollo* mission. . . . There is no evidence that they are building a booster as large as the Saturn V . . . I think the information of most value to the U.S. Government is that they are conducting a very broadly based program, *developing* every competence necessary to select those missions that they believe will be to their advantage as they develop their competence."

The NI Rocket

One of the "competences" that the Soviets were not busy developing was a high-energy cryogenic engine for the NI. From 1960 to 1964, every technical plan for the NI had included LOX-liquid hydrogen rocket engines for the upper boost stages of the NI, much like the Saturn V. As a result of Korolev's vigorous push, and despite Glushko's attempts at smothering such attempts, Chief Designers Isayev and Lyulka were tasked with the creation of three different engines:

- The IID54, with a thrust of forty tons for the NI's Blok V third stage
- The IID56, with a thrust of seven and a half tons for the NI's Blok R upper stage
- The IID57, with a thrust of forty tons for the NI's Blok S upper stage⁵¹

The IID56 was developed by Isayev's design bureau, while the remaining two were developed by Lyulka's organization. By 1965, work on the engines was moving at a snail's pace. Isayev's engine was further ahead in the development program, but the lack of adequate testing facilities at NI-229 in Zagorsk forced significant delays in ground testing. Not one engine, in fact, had been fired on the ground by the end of 1966. With continuing delays in the liquid hydrogen program, Korolev and Isayev decided to delay the use of such engines to later versions of the NI. Thus, OKB-I engineers had to explore other options in redesigning the NI. The solution was simple, but it cost the NI significant losses in lifting capabilities. Gone were the liquid hydrogen third stages and Bloks S and R; instead, the engineers introduced two additional stages as part of the L3 payload, both powered by the more traditional LOX and kerosene. To minimize significant new work, OKB-I engineers decided to use already prepared stages and engines. The first of the two additional stages, Blok G, was merely a single engine of the same type as the NI's third stage, but it was modified for higher altitude operation. The second of the stages, Blok D, was appropriated from the canceled GR-I's third stage."

51. *Soviet Space Programs, 1962-65: Goals and Purposes, Achievements, Plans, and International Implications*, prepared for the Committee on Aeronautical and Space Sciences, U.S. Senate, 89th Cong., 2d sess. (Washington, DC: U.S. Government Printing Office, December 1966), pp. 388-89.

52. Semenov, ed., *Raketno-Kosmicheskaya Korporatsiya*, p. 262. The IID54 had a fixed chamber, while the IID57 was capable of gimbaling.

53. *Ibid.*, p. 252. Strictly speaking, the IID58 engine on Blok D was developed on the basis of both the 8D726 engine (GR-I third stage) and the IID33 engine (8K78 fourth stage). See *ibid.*, p. 226.

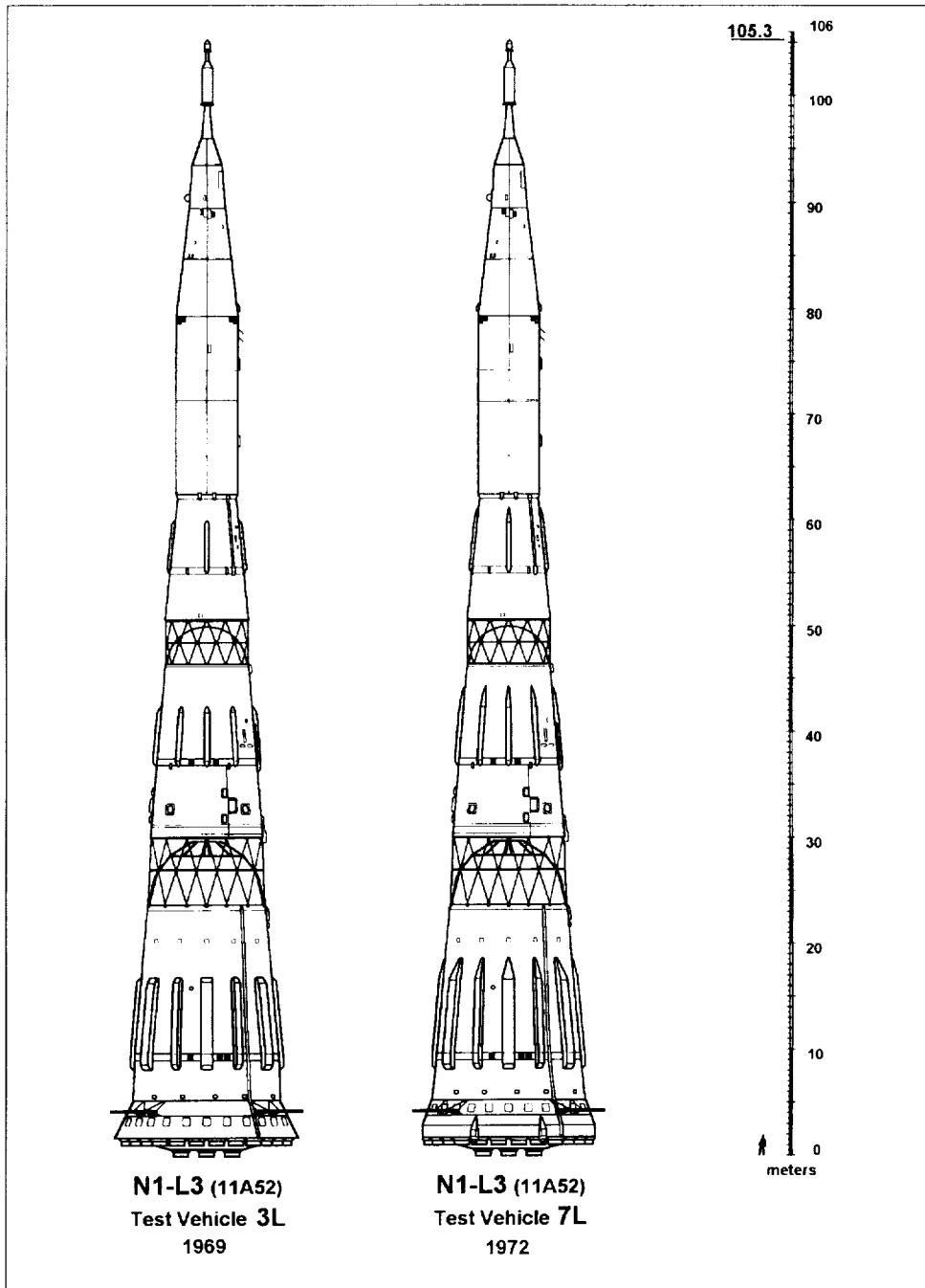

On the left is the early test variant of the N1 rocket as originally conceived in the mid-1960s. On the right is a slightly modified version designed in the early 1970s. The main external differences were in the fairing at the bottom of the first stage and the length of the vertical conduits on the first and second stages. (copyright Peter Corin)

CHALLENGE TO APOLLO

The adoption of LOX-kerosene for the first five stages of the NI-L3 complex allowed OKB-1 engineers to inch slowly to the completion of the final draft plan, which was completed and signed by Korolev and Mishin on November 11, 1965, amid the cacophony of uncertainty surrounding the fate of the project. Once again, the Keldysh Commission convened to examine the technical details and characteristics of the NI-L3, this time within the framework of the more detailed draft plan rather than the predraft plan. The approval was quick. In December 1965, the commission approved the plan, giving it the formal recommendation to begin manufacture based on the revised specifications."

The Soviet NI booster had the highest liftoff thrust of any rocket built in the history of space exploration. The basic rocket consisted of three conical rocket stages—Blok A (first stage), Blok B (second stage), and Blok V (third stage)—with a total length of 61.55 meters. The first stage was powered by thirty NK-15 engines, each having a ground level thrust of 154 tons. Of the thirty engines, twenty-four were installed around the perimeter, while the additional six were located at the center in the form of a ring. Total liftoff thrust was 4,620 tons, compared to the Saturn V's 3,404 tons. Burn time for the stage was in the range of 114 to 120 seconds. The stage also had four independent engines for roll control developed by OKB-1, each with a thrust of seven tons. The upper portion of the stage was not a solid frame, but rather was composed of a lattice-type structure that served as an interstage section between the first and the second stages. The top portion of the gigantic kerosene tank was visible through this lattice. A total of twelve conduits installed around the lower part of the exterior of the stage served as a means to carry fuel from the upper propellant tank to the engines at the base of the stage. The 30.09-meter-long stage had a base diameter of 16.87 meters, which did not include four large grating-type stabilizers near the base positioned orthogonally at ninety degrees to the main vertical axis.

The 20.46-meter-long second stage was powered by eight NK-15V engines, each with a thrust of 179 tons, giving a total stage thrust of 1,432 tons. Burn time was in the range of 130 seconds. The NK-15Vs were essentially NK-15 engines modified for work at high altitudes with longer and thinner nozzles. There were eight conduits for propellant transfer attached around the exterior of the stage. A lattice structure connected this stage to the next one, while roll control was effected by means of three small engines, each with six tons thrust. The third stage was powered by four NK-21 engines, each with a thrust of forty-one tons, giving a total third-stage thrust of 164 tons. The length of the third stage was just over eleven meters. Four external conduits on the exterior allowed propellant transfer, while four 200-kilogram thrusters provided roll control. All the engines of the first three stages used LOX as oxidizer and kerosene as fuel, were of the staged combustion cycle type, and were developed by OKB-276 under Chief Designer Nikolay D. Kuznetsov.

There were some unique features of the NI that set it apart from most other space launch vehicles of the time. The propellant compartments of the first three stages of the vehicle were suspended spherical tanks separate from the external frame of the booster. The load-bearing configuration, and the relatively low density of the layout because of the use of spherical tanks, resulted in a significant diminution of the payload mass of the rocket. To circumvent this weakness, the engineers designed the tanks with unusually low specific mass, which, when combined with the high performance of the engines, effectively compensated for the drawbacks of having a nonmonocoque main rocket body. The spherical tanks were subject not only to loads from the pressure associated with tank pressurization but also the hydrostatic pressure of the liquid in them. Inertial loads and engine thrust were absorbed by the propellant compartments' load-bearing structure.

There were both advantages and disadvantages to the spherical design of the tanks, certainly one of the most unusual features of the rocket. Spheres have minimal surface area relative to volume, and thus they are subject to lower heating loads and require minimal surface insulation. The engineers also concluded that with spherical tanks and prepump engine assemblies, the mass of propellant tanks would be smaller than those of rockets with regular propellant tanks as load-bearing structures. Although participants in the N1 program later claimed that the selection of tanks separate from the main body was primarily motivated by the search for better characteristics, in truth there was a more pressing reason for such an unusual design: the Soviet metallurgical industry was unable to produce aluminum sheets more than thirteen millimeters thick. For integral tanks, the engineers calculated that the thickness would have to be much greater; therefore, the only option was to use nonintegral tanks. One major deleterious factor was the fixed cost resulting from the design and construction of numerous size-specific welding jigs and dies, one for each of the six tanks. The booster's six spherical tanks, two in each stage, had diameters between 12.8 and 4.9 meters. The tanks themselves were built from a special magnesium-nickel alloy named AGM6, while the external casings of the N1 were built from duralumin D16. The Ye. O. Paton Institute of Electrical Welding at Kiev, led by Academician Boris Ye. Paton, developed a new method of arc argon welding with subsequent tests by x-rays, which allowed for the creation of lighter tanks than possible with earlier assembly methods.

Superior engine performance was achieved by the use of built-in impeller-type preliminary pumps and automatic control with igniters, a first for Soviet rocket engines and possibly in the world. This design was evidently based on the earlier NK-9 for the abandoned GR-1 booster, which had removable preliminary pumps. The idea stemmed from attempts to boost the performance of the engines for conditions that were more severe than projected launch conditions. The exhaust from the starter turbine of the engines of all the N1 main engines was directed below by using a diverter duct outside the nozzle exit area. This particular duct, in fact, was the reason why the engines themselves had a peculiar appearance—that is, they were closed-cycle (staged combustion cycle) engines, but with an exhaust duct outside the nozzle originating from the turbopump assembly. Through the entire period of development, Kuznetsov was forced to make significant changes to his original conceptions from 1962. One of Korolev's stringent requirements was that the engines be extremely lightweight. Despite major difficulties, Kuznetsov's NK-15 engine had one of the best dry mass-thrust ratios of rocket engines of this class and type.

A third unusual feature of the rocket was the built-in redundancy of the engines installed on the stages. Because there were so many engines on the first stage, Korolev's engineers raised the total reliability of the propulsion system by means of the in-flight shutdown of faulty engines. For example, if there was a malfunction in one of the engines on Blok A, signals from the Engine Operation Control (KORD) system's sensors were immediately sent to valves that mechanically cut off the feed of propellant components to the malfunctioning engine. In addition, the engine diametrically opposite to the faulty one would be switched off simultaneously to preclude unbalanced loads during the powered portion of the trajectory. In such a situation, the remaining engines would continue to burn for an extended period of 168 seconds with slightly increased thrust. If two pairs of engines failed, the remaining engines would burn for as much as 210 seconds, depending on the parameters of the trajectory. The KORD system also operated on the second and third stages. It could shut down two engines on Blok B and one engine on Blok V, with other engines continuing to fire.

Guidance and control systems for the N1, including the KORD system, were developed by Chief Designer Pilyugin at the Scientific-Research Institute of Automation and Instrument Building. OKB-1 developed the N1's tri-level telemetry system. This included the RTS-9 for

slow-changing parameters, the BRS-4 for fast-changing processes, and the APG-4 automatic data recording system.

Another departure from previous Soviet rockets was the manner in which thrust vectoring was accomplished on the vehicle. Pitch and yaw on the first two stages were effected by mismatching the thrusts of opposing fixed peripheral engines. The third stage had the ability for traditional gimbaling. Roll maneuvers were accomplished by the small swiveling nozzles on the periphery of the rocket, the gases for which were transferred from the turbines of the turbo-pumps of the main engines.

Power for on-board systems was ensured not by batteries, as on all previous Soviet rockets, but by a special "electrical station" developed by Chief Designer Andronik I. Iosifyan's NII-627 in cooperation with Chief Designer Arkhip M. Lyulka's OKB-165. Electric turbogenerators operating on pressurants such as air or helium from the propellant tanks provided twenty kilowatts of power that was essentially "free of charge," fully automated, and maintained to a stable output by the use of a quartz oscillator."

The NI-L3 lunar complex as a whole was designed at OKB-1's Department No. 3 headed by Yakov P. Kolyako, under the overall direction of Deputy Chief Designer Kryukov."

The L3 Lunar Rocket Complex

The total length of the complete NI-L3 on the pad was 105.3 meters, of which the L3 portion was 43.2 meters. The L3 complex consisted of the following sections: Blok G (fourth stage) of the NI-L3 complex and the Lunar Orbital Station consisting of vehicles for work in lunar space. Blok G served as the TLI stage and was powered by a single NK-19 engine, almost identical to the engine used on the NI's third stage. With an external diameter of just over four meters and a length of eight meters, the stage was sufficiently small to be transported by rail to the launch site much like Chelomey's Proton booster, which had the same external diameter. Blok G would ensure a 480-second burn sufficient to reach 11.2 kilometers per second—that is, enough to boost the Lunar Orbital Station toward the Moon.

The Lunar Orbital Station consisted of the following components, in order from bottom to top on the launch stack:

- Blok D
- The Lunar Ship (LK)
- The Lunar Orbital Ship (LOK)

The Blok D stage, effectively the fifth stage of the NI-L3, was one of the most important components of the entire complex, because it would perform several burns critical to a successful lunar landing. These would include two to three burns on the way to the Moon for course corrections, the lunar-orbit-insertion burn, two to three corrections in this orbit, and the initial portion of the powered descent burn from lunar orbit. The stage thus had to be equipped

55. V A Lebedev. "The NI-L3 Programme," *Spaceflight* 34 (September 1992): 288-90; Semenov, ed., *Raketno-Kosmicheskaya Korporatsiya* pp 248-55; Lardier, *L'Astronautique Soviétique*, p. 166; Afanasyev. "NI: Absolutely Secret: Part II"; Igor Afanasyev. "NI: Absolutely Secret: Part III" (English title), *Krylya rodny* no. 11 (November 1993): 4-5; Dorofeyev. "History of the Development of the NI-L3 Moon Program"; N. I. Panichkin. "Some Results of NI Development with Multi-Engine Powerplants," presented at the 10th International Symposium on the History of Astronautics and Aeronautics; Rebrov "But Things Were Like That"; Mishin, "Why Didn't We Fly to the Moon?"; Marinin and Shamsutdinov. "Soviet Programs for Piloted Flight to the Moon "

56 Semenov, ed., *Raketno-Kosmicheskaya Korporatsiya*, p. 252

with a rocket engine that not only could function reliably in conditions of vacuum and weightlessness for more than a week, but also be capable of repeated firings. The critical engine used on the stage, derived from work on the GR-1 and the fourth stage of the 8K78 Molniya space launcher, was the ID58 with a vacuum thrust of eight and a half tons and a specific impulse of 349 seconds. Engineers used a new kerosene derivative named RG-1 as the fuel, which ensured better cooling characteristics than earlier kerosene derivatives such as T-1. Propellant boiloff during space operations was also prevented by thermal insulation on Blok D itself. The oxidizer was LOX. In addition to the main engine, the Blok D stage also included two System for Ensuring Firing (SOZ) engine units, each with two throttle-capable motors of ten kilograms thrust (one reserve). These engines were for settling the remaining propellant of Blok D prior to firing in weightless conditions and were developed by TMKB Soyuz (formerly the Turayev branch of OKB-300) headed by Chief Designer Vladimir G. Stepanov. The Blok D engine was one of the few rocket engines developed in-house at OKB-1, whose derivations can be traced back a decade to the steering thrusters used on the original R-7 ICBM.

Like the earlier engines, Blok D work was overseen by OKB-1 Deputy Chief Designer Mikhail V. Melnikov. The stage was 5.7 meters in length, with an outer jettisonable cylindrical shell, and had an external diameter of 3.7 meters.

The central component of the entire lunar stack was the LK lander, positioned on top of Blok D on the pad. Engineers at OKB-1's Department No. 93 under Ivan S. Prudnikov were responsible for designing and developing the vehicle under the overall supervision of Deputy Chief Designer Bushuyev. Although the predraft plan for the spacecraft was finished at the end of 1964, the primary elements of the design of the lander underwent significant changes by the time that the final scheme was adopted in 1967 or 1968.

The primary constraint that dictated the eventual design of the LK was mass. Computations showed that with the new and improved NI, along with Bloks G and D, such a lunar lander could weigh a maximum of five and a half tons. This was in comparison to the almost fifteen tons that NASA's Lunar Module weighed. Given the generally heavier microelectronics components and the relatively poor capabilities of Soviet computers, this was indeed a tall order for Korolev's engineers. The Soviets benefited from having only one cosmonaut in the lander, although this raised a number of other questions that would compromise safety. The mass limit meant that the Soviets would have to do with one set of engines for both landing and liftoff, instead of the two separate units as on the Apollo Lunar Module. This meant that unlike the two-stage Lunar Module, the Soviet lander would essentially be a one-stage vehicle.

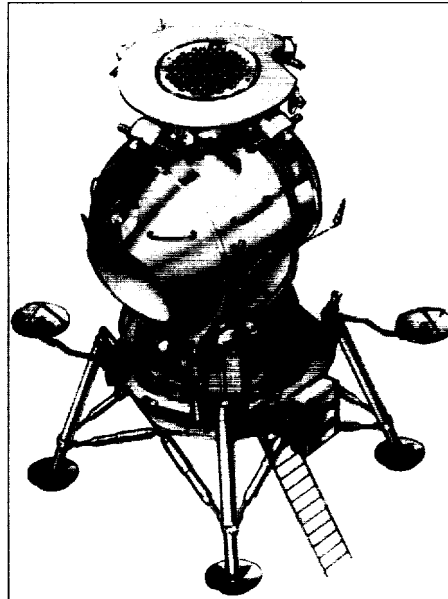

The Lunar Ship (LK) of the L3 lunar landing complex would carry a single cosmonaut to the surface of the Moon. Note the honeycomb structure on the docking plate at the top of the lander, which was capable of receiving the active docking probe on the LOK lunar orbiter (copyright VideoCosmos Co. via Dennis Newkirk)

Save for its landing supports and some associated instrumentation, at liftoff, the LK would essentially be the same vehicle that had landed. After several changes in design in 1964, the basic chosen design was of a rocket stage with landing supports, topped off by a crew cabin. The crew cabin went through four different iterations before arriving at its roughly spherical shape. The final layout of the LK consisted of the following three sections:

- The Lunar Landing Aggregate
- The Lunar Takeoff Apparatus
- Blok Yé

The Lunar Landing Aggregate and the Lunar Takeoff Apparatus were analogous to the descent stage and the ascent stage, respectively, of the Apollo Lunar Module.

The Lunar Landing Aggregate was a 2.27-meter-diameter frame shaped like two truncated and ribbed cones with their bases attached to each other. The dimension of the chassis was determined by the distance from the main engine's nozzle exit section to the mainframe of the oxidizer tank, a scant 600 millimeters. A pressurized suspended instrument compartment with the *Planeta* ("Planet") landing radar and research equipment, with a mass of 105 kilograms, was attached on the exterior of the Lunar Landing Aggregate. This compartment included an "operational manipulator" (59.17 kilograms) and a lunar surface drill, which was capable of operating for sixty minutes. The Lunar Landing Aggregate also included two folding pencil-beam parabolic antennas of the radio communications system, in addition to three storage batteries, a fold-down ladder to allow the single cosmonaut to step down onto the surface, and four water-filled cylinders for the evaporator of the thermal regulation system. Later models were to include a small automated four-wheeled rover as well as a second scientific experiments package.

The actual landing supports for the ship, four legs attached to a frame, were collectively known as the Lunar Landing Unit. Because knowledge of the lunar surface in 1964 was still rather sparse, it was a challenge to set specifications for the landing supports. Korolev gave his engineers two primary requirements: (1) the ship should be able to safely drop from a height of one meter with a lateral velocity of one meter per second and (2) the landing gear should be able to prevent the lander from capsizing, even if the surface was sloped. Assuming that the "most likely" diameter of lunar craters would be seven meters, the slope limit for a landing was set at twenty degrees to the horizontal. These two restrictions served as the basis for almost twenty different proposals for landing supports, including a supporting ring much like an inflatable inner tube at the base of the vehicle. After examining tripod-support schemes, engineers finally settled on a four-support design as the most stable in the given conditions.

In its final conception, the Lunar Landing Unit was simply a honeycomb shock-absorbing structure with four legs, on which the spacecraft would rest on the Moon. Lateral supports for the legs muffled loads by compression and extension, while compressible near-vertical struts that ended in saucer-shaped footpads were for setting down on the surface. Four solid-propellant "hold-down" engines at the upper end of the landing legs were to fire at the exact moment of touchdown to ensure that the vehicle would not topple over on the surface or "hop" following first contact with the lunar surface.

The Lunar Takeoff Apparatus was the roughly spherical crew module for the lone cosmonaut during the lunar surface stay. It consisted of a pressurized cabin, a stubby cylindrical instrument compartment enclosed by a dome stuck to the side of the sphere, and a section for attitude control engines attached at the top. The cramped cabin itself was two and three-tenths meters by three meters in size and had an internal volume just enough for a standing cosmonaut in a spacesuit who would be harnessed securely in front of the instrument display and main control panel. The latter was designed and built by the Special Experimental Design

Bureau of the Flight-Research Institute at Zhukovskiy-2, near Moscow, under the leadership of Chief Designer Sergey A. Borodin. The panel was located to the right of the cosmonaut, allowing the pilot's right hand to control key parameters of the vehicle. All systems had both an automatic mode of control and a manual override.

A hemispherical concavity in the forward portion of the module contained a view port and a collimator device with a seven-degree angle of view on which an image of the landing site would be projected. During descent, the device would allow the cosmonaut to observe the landing area and the landing supports visually and take over manual control in an emergency situation. A large control stick would allow the cosmonaut to align the landing site on the collimator with the planned landing site, forcing the ship to travel to the desired location. A second port with a wide-angle sight was located above the concavity for the pilot to observe docking operations in lunar orbit with the "mother ship." The exterior of the cabin included four antennas, two omni-directional ones and two for rendezvous operations. Most of the instrumentation associated with the functioning of the crew cabin (orientation and control instrumentation, radio communications devices, and so on) was "pushed out" into the laterally placed oval instrument module. Two batteries, similar to the ones on the Lunar Landing Aggregate, were also installed on the instrument section to power the spacecraft after liftoff. The docking unit of the LK was installed on top of the vehicle much like on the U.S. Lunar Module. A flat annular radiator screen of the thermal regulation system around the docking unit protected the cabin against collision during a potentially incorrect alignment during docking in lunar orbit.

The designers chose the internal atmospheric pressure based on careful analysis because the pressure influenced the thickness of the main shell of the spacecraft, which in turn affected the mass. Unusually for the Soviet piloted space program, engineers initially chose a pure oxygen atmosphere, but because that would require the creation of extra accessories, special production technologies, and more safety measures, they fell back on the traditional ordinary air composition, but with a reduced nitrogen content. In the 560-mm Hg pressure, the cosmonaut would be able to remove his spacesuit helmet for eating and drinking. At the time, Soviet space engineers overwhelmingly preferred using airlocks for extravehicular activity (EVA), but installing an airlock on the LK was out of the question because of mass constraints. Depressurization, as with the Apollo Lunar Module, was the only remaining option. The cabin was designed such that both ground control and the cosmonaut could manually lower pressure. The internal climate of the cabin was maintained by a gas-liquid heat-exchange system and ventilator. The life support system was designed for a nominal operation of forty-eight hours, also limited by the power of the on-board batteries. All life maintenance systems, including the thermal regulation systems, were designed and developed by Chief Designer Voronin's KB Nauka (formerly OKB-124).

Throughout all operations from lunar orbit to landing and then subsequent takeoff, the commander of the mission would wear a special new semi-rigid spacesuit developed by KB Zvezda (formerly Plant No. 918) based at Tomilino under the leadership of Chief Designer Severin. The suit had to be flexible enough to allow for not only surface operations on the Moon, but also EVA in lunar orbit, when the moonwalking cosmonaut would transfer from the lander to the mother ship via a spacewalk. Severin's engineers developed a "portable suit" with armored head and torso portions and soft arm and leg sections. Instead of donning the suit like a typical article of clothing, the cosmonaut would literally enter the suit via a door at the backside. The suit's life support system was mounted in a large backpack attached to the door at the back of the suit. The backpack, nicknamed *Kaspiy*, included a life support system that would ensure thermal control, suit pressurization, air collection, purification, and dehumidification via a network of water-cooled plastic tubes. A hinged control panel on the chest of the cosmonaut provided control over eleven parameters of suit operation in addition to communi-

cations, each with a primary and backup loop. The suit also included a beacon system to allow ground controllers to determine the exact position of the cosmonaut relative to the lander. Within the lunar lander, because of mobility constraints, the cosmonaut would use a special finger control unit to reach inaccessible control buttons. The size of the spacesuit necessitated the use of a large oval hatch on the side of the Lunar Takeoff Apparatus, the first in the history of the Soviet space program. Severin's engineers named the suit Krechet-94 ("Falcon"), with the "94" coming from the production index of the lunar lander, which was 11F94.

The guidance and control system of the LK was the heart of the ship. Several different design bureaus and institutes under the leadership of the Scientific-Research Institute of Automation and Instrument Building, headed by Chief Designer Pilyugin, designed and developed this system. The goal of the system was to control powered descent from lunar orbit, the landing, the takeoff, and the subsequent docking with the LOK. For the first time in a Soviet piloted vehicle, engineers used an on-board microcomputer to evaluate all incoming information from a variety of sensors, to evaluate the state of the lander based on preprogrammed algorithms, and then to take a course of action. The primary sensor system consisted of a set of gyroscopes as part of a three-axis gyrostabilized platform for spatial orientation, the Planeta landing radar for measuring velocity and altitude, the collimating sight, and other electronic measurement systems. These gyroscopes were developed by the Scientific-Research Institute for Applied Mechanics headed by Chief Designer Kuznetsov. Pilyugin's guidance system also included a semi-automatic system for controlling horizontal movement and angular velocity during rendezvous and docking operations, as well as a manual control system that would allow the pilot to select a landing site using the collimating sight. The pilot would use a two-channel lever for controlling attitude and relative change of horizontal velocity of the lander. Using the collimator to view the landing site, the pilot would feed data to the computer to produce commands for the necessary maneuvers to achieve an on-target and safe landing. Solar and planetary sensors would verify the accuracy of the orientation of the axes of the gyrostabilized platform.

At the time of liftoff from the Moon, the Lunar Takeoff Apparatus would detach itself from its landing supports (the Lunar Landing Unit) and additional instrumentation (the Lunar Landing Aggregate) attached to it. The Lunar Takeoff Apparatus would lift off with only the pressurized spherical compartment with the cosmonaut and the same engine unit that had landed it. Electrical and hydraulic connections between the two spacecraft, provided via an umbilical tower, would move away at a safe range prior to liftoff. One of the advantages of the design was that there was no need to develop a special and separate landing stage. For landing, the Blok D stage would reduce velocity in lunar orbit sufficiently so that only a relatively small engine was required for the disembarking operations. The throttleable main engine would enable the cosmonaut to hover over the lunar surface for a very short time to select a safe landing area. The hover time was less than a minute and was dictated by fuel volume of the main engine. Because of mass constraints, any science package aboard the LK would be very small, thus limiting actual scientific exploration.

The primary attitude control complex was located on top of the crew cabin in a 0.68-meter-tall compartment underneath the docking collar. The system consisted of two vacuum-fueled tanks (fuel and oxidizer) carrying 100 kilograms of liquid propellant and a propellant delivery system. There were four sets of engines, each with four thrusters, of which eight would have a thrust of forty-nine kilograms and eight would have a thrust of ten kilograms. The complex was divided into two independent circuits to overcome failure in one circuit. Each circuit controlled two forty-kilogram thrusters for pitch, two forty-kilogram thrusters for yaw, and four ten-kilogram thrusters for roll. The impulses from the thrusters were accurate enough to provide only nine milliseconds of thrust. Although Chief Designer Stepanov's TMKB Soyuz designed and developed the engines for the attitude control system, the organization declined to develop the

remaining components, such as the actuator system, the propellant tanks, and the propellant-feed system, which were all created at OKB-1 under First Deputy Mishin's direct leadership.

During a nominal mission, the LK would communicate with Earth and the lunar orbiter via antennas that would operate in the meter, decimeter, and centimeter ranges. One antenna was installed on the docking ring for "weak" signals, while two omni-directional antennas were at the base of the crew cabin and two TV antennas were on the Lunar Landing Aggregate. A TV camera installed above the ladder would transmit live pictures of the cosmonaut's disembarkation onto the lunar surface.

A large docking assembly was installed on the top of the Lunar Takeoff Apparatus. Because of the mass and constraints, Korolev's engineers opted to design a system that, like the Soyuz 7K-OK, did not allow for internal transfer. While this considerably lightened and simplified the docking systems on the lunar lander and the lunar orbiter, this also meant that the landing cosmonaut would have to spacewalk his way from one ship to the other during transfer operations. Engineers rationalized this extra EVA by arguing that the cosmonaut would have to leave the spacecraft for surface operations anyway, and two more EVAs would not significantly add to mission complexity, as would a heavy and unique internal transfer system. In contrast to the Soyuz docking system, which had a pin-cone system, the lunar lander-orbiter system was designed exclusively for one docking. The active assembly on the orbiter ship had a pin and simple shock absorbers, while the passive assembly on the lander consisted of a flat circular honeycomb structure one meter in diameter. This plate contained 108 recessed hexagonal honeycomb components. During the single docking required in lunar orbit, it would be sufficient for the lunar orbiter to place the pin in any location in the plane of the passive assembly. The pin would penetrate the honeycomb structure and be captured by "claws" within, pulling the two spacecraft together. The connection was only mechanical: there were to be no electrical or power transfers between the two vehicles. The main rendezvous radar was placed adjacent to the passive docking unit, somewhat similar to a chimney, and was part of the *Kontakt* system designed and developed by NII-648 under Chief Designer Mnatsakanyan, the same organization responsible for Soyuz's Igla radar system. Two more antennas, also part of the Kontakt system, were installed on the exterior of the crew module.

Blok Ye, with a mass of two tons, was the main propulsion unit for landing on and lifting off from the surface of the Moon. This most critical component of all was not developed by OKB-1. When Korolev had first begun planning for the L3 complex, he had repeatedly stressed that the effort be a collaborative effort with some of the other major design bureaus involved at the time in aviation and missile development. As part of this conception of the lunar effort, Korolev had signed a preliminary agreement with Chief Designer Mikhail K. Yangel of OKB-586 to design and develop the rocket stages for the entire L3 complex: the Blok G, Blok D, Blok Ye, and Blok I stages. In January 1965, Yangel's First Deputy Chief Designer Vasiliy S. Budnik, one of Korolev's old proteges from the 1940s, wrote back to Korolev that OKB-586 would be unable to honor its commitment because of an overload of other work. In the following months, however, Korolev and Yangel eventually came to an agreement: the latter agreed to create only the engine for the LK.

The project to create this engine was fraught with difficulty, not the least because of its paramount importance in the NI-L3 lunar landing profile. Engineers calculated that the main and backup engine of Blok Ye had to have a reliability of 99.976 percent, certainly an unheard-of level in Soviet rocket engine industry. The overall responsibility for the stage's development fell on the shoulders of OKB-586 Chief Engineer Boris I. Gubanov, the same man who would twenty years later go on to head the development of the giant Energiya booster.

Being the heaviest element of the spacecraft and accounting for half the total mass, the Blok Ye engine unit was installed as low as possible within the lunar lander to ensure maximal stability. Its oxidizer (nitrogen tetroxide) tank was installed as a torus around the main engine

CHALLENGE TO APOLLO

itself. There was also a lenticular tank (unsymmetrical dimethyl hydrazine) for the fuel. It was rigidly attached to the lower part of the Lunar Takeoff Apparatus and had a throttleable single-chamber engine (RD-858) and a two-chamber nonthrottleable backup engine (RD-859), each with a thrust of 2.05 tons. The backup engine had two nozzles, one on each side of the primary engine nozzle in the center underneath the vehicle. The engine nozzles had covers to prevent debris from blocking the exhaust pathway. At liftoff, both engines were to fire until the primary one reached full thrust, at which time, following a computerized diagnosis of the operational characteristics of the primary engine, the backup unit would be turned off. The main engine of Blok Yé was designed to ensure vertical braking and horizontal maneuvering from an altitude of one to three kilometers down to a few hundred meters off the surface. Thrust could be reduced from two tons down to 860 kilograms."

The third major component of the lunar stack, after Blok D and the LK, was the LOK. The spacecraft was designed as a modification of the early Soyuz 7K spacecraft, upgraded for operations in lunar orbit. Also known as the 7K-LOK, the lunar orbiter would be yet another variant of the basic 7K spacecraft, underlying the status of Soyuz as truly a universal spaceship for the next generation of Soviet piloted programs."

Like the basic Soyuz spacecraft, the 7K-LOK consisted of three major compartments: the major difference was the addition of a fourth section. These compartments were, from the forward end of the ship to the aft end:

- The living compartment
- The descent apparatus
- The instrument-aggregate compartment
- The Blok I engine

The first three sections served in much the same capacity as they would on Earth-orbital Soyuz missions. The living compartment was a spheroid section, which would allow the crew to rest on the long lunar trip and also serve as an airlock chamber for EVA operations. The 2.26-meter-long module had two hatches, one in the rear for transfer into the descent apparatus and one on the lateral side for exit into open space. The module also included a cupboard, one *Orlan* ("Bald Eagle") EVA suit, food, water, cameras, and life support systems. A control panel at the forward end of the sphere would allow the flight engineer cosmonaut to control the vehicle during approach and docking in lunar orbit. One major difference from the Earth-orbital Soyuz was the installation of the large orientation engine complex at the forward end of the entire spacecraft. This 800-kilogram section with a length of just over one and a half meters

58 Ibid., pp 252-54; V. Filin. "At the Request of the Reader The NI-L3 Project" (English title). *Aviatsiya i kosmonautika* no. 1 (January 1992) 28-29, 40; Afanasyev. "Unknown Spacecraft". Marinin and Shamsutdinov, "Soviet Programs for Piloted Flight to the Moon"; Luc van den Abeleen "Soviet Lunar Landing Programme." *Spaceflight* 36 (March 1994) 90-92; K Lantratov. "The Fall From Orbit of the Last Soviet Lunar Ship" (English title). *Novosti kosmonautiki* 25 (December 3-16, 1995): 32-36; *Russian Space History*, Sale 6516 (New York: Sotheby's, 1993), description for lot 49; Yu. V. Biryukov, "Seventieth Birthday of Vladimir Fedorovich Utkin" (English title), *Zemiya i vseleinnaya* no. 3 (May-June 1994) 45-50, S. N. Konyukhov and V. A. Pashchenko. "History of Space Launch Vehicles Development," presented at the 46th Congress of the International Astronautical Federation, IAA-95-IAA 2.2.09, Oslo, Norway, October 2-6, 1995, S. Konyukhov and L. Andreyev. "M. K. Yangel: The Unknown Pages of Biography," presented at the 45th Congress of the International Astronautical Federation, IAA-94-IAA.2.2 619, Jerusalem, Israel, October 9-14, 1994; Interview, Vladimir Agapov with the author, September 30, 1996. A. Yasinskiy. "To Touch the Moon" (English title). *Apogey* 3 (January 1993) 2-3.

59 By 1965, the following variants of the Soyuz were under study or in design: 7K-OK for Earth-orbital operations, 7K-VI for Earth-orbital military operations, 7K-LOK for lunar-orbital operations; and 7K-PLK, 7K-OK-T, and 7K-LI for circumlunar missions.

included six spherical tanks containing a total of 300 kilograms storable propellant (unsymmetrical dimethyl hydrazine and nitrogen tetroxide) as well as four gas-filled cylinders for supercharging the tanks. The tanks would service four sets of engine units placed around the forward end of the spacecraft with their own rendezvous antennas. This orientation engine complex would carry out all attitude control for the large spacecraft during the critical operations in lunar orbit. The active end of the Kontakt docking system was placed at the very apex of the orientation engine complex, allowing for a single docking with the lunar lander.

The beehive-shaped descent apparatus was similar to the one on the basic Soyuz. It was 2.19 meters long and 2.2 meters wide and would carry the two-person crew during launch and landing. It contained control panels for the ship's systems, life support systems, an on-board computer, and a hatch at its apex for transfer into the living compartment. Throughout the flight, the capsule would be covered by thermal shielding insulation and a strengthened heat shield at the base, which would be cast off following reentry, but prior to touchdown on the ground. Like the 7K-OK Soyuz, the lunar 7K-LOK Soyuz was equipped with hydrogen peroxide engines for guiding the ship during reentry.

The cylindrical instrument-aggregate compartment was analogous to the one on the basic Soyuz, and it had a diameter of 2.2 meters and a length of 2.82 meters. It consisted of three sections: the pressurized instrument compartment, the unpressurized transfer compartment, and the aggregate compartment. The instrument compartment carried equipment for the ship's radio communications, telemetry, and command radio-link systems, as well as several attitude control engines for use during rendezvous, all of which were vastly improved from the version carried on the Earth-orbital Soyuz.

The fourth and final section of the Lunar Orbital Ship was the one that distinguished it from the original Soyuz, the Blok I engine stage. Unlike the Soyuz, the aft end of the ship ended in a unique skirt-shaped compartment, which contained the restartable Blok I engine as well as the power compartment. This engine, known as the 5D51, had a singular mission: to fire the spacecraft out of lunar orbit on its way back to Earth. The engine consisted of a two-chamber propulsion unit with a thrust of 3.388 tons, whose exhaust nozzles were located at the base of the large skirt. A separate single-chamber engine with a thrust of 417 kilograms, which was almost identical to the primary engine of the Soyuz spacecraft, was also installed at the rear end of the skirt. Capable of multiple firings (up to thirty-five times), this smaller engine would ensure orbital changes during lunar-orbit operations. Both engines were fed by a common propellant supply composed of a large 1.9-meter-diameter spherical tank separated by an internal partition for isolating the unsymmetrical dimethyl hydrazine and nitrogen tetroxide. The major portion of the tank was within the cylindrical aggregate compartment, with part of it jutting

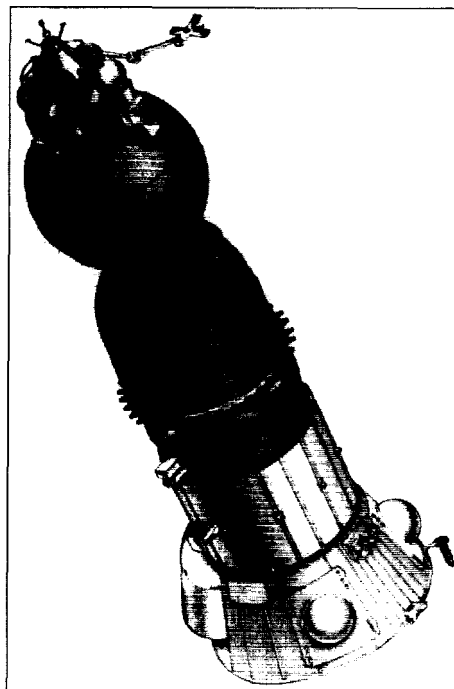

The Lunar Orbital Ship (LOK) of the Soviet L3 lunar landing complex would play an analogous role to the Apollo Command-Service Module remaining in lunar orbit while the lander carried a single cosmonaut to the surface of the Moon. Note the skirt at the base of the spacecraft, a visible difference from the basic Earth orbital Soyuz. (copyright VideoCosmos Co. via Dennis Newkirk)

into the skirt. Although Yangel had agreed initially to build the Blok I engine, by May 1965. Korolev had signed a technical requirement with Chief Designer Isayev of OKB-2 to design, develop, and deliver the engine. Isayev was also responsible for the smaller engine, which was virtually identical to the one he was designing for the Earth-orbital Soyuz. The skirt at the end of the 7K-LOK spacecraft also included sixteen tiny engines for attitude control, fueled by the same tanks for the two main engines. The power compartment contained the *Volna-20* ("Wave") fuel cell for ensuring an electrical supply throughout the mission. It would be the first time that hydrogen-oxygen fuel cells were used on a Soviet piloted spacecraft. On contract to the Ural Electrochemical Company, the system had a mass of seventy kilograms and was capable of providing one and a half kilowatts at twenty-seven volts for a period of 500 hours. Maximum flight time for a fully equipped ship was about thirteen days. The LOK as a whole was just over ten meters in length, with a maximum diameter of 2.93 meters and a mass in lunar orbit of 9.85 tons."

The final element of the NI-L3 stack was a launch escape tower, similar in design to the one on the Soyuz booster, but scaled upwards to support the increased masses of the living compartment and descent apparatus. The system, consisting of two levels of solid-propellant engines fixed to a tower above the launch stack, was equipped to remove the crew a further distance away from the pad than for standard R-7-class boosters, because the power of an NI explosion on the pad would have a far wider radius of destruction.

The complete NI-L3 profile, as tweaked and modified over 1965–69 was as follows. The 2.750-ton complex is launched from Tyura-Tam with its two-cosmonaut crew. During operation of the Blok B second stage, the huge external fairing of the L3 and the emergency rescue system is jettisoned. The first three stages—Blocs A, B, and V—of the NI then insert the entire ninety-one-and-a-half-ton L3 stack into a 220-kilometer orbit around Earth nine minutes after launch. Following a thorough systems checkout in Earth orbit for about 24 hours, the Blok G stage fires at a predetermined point on the complex's seventeenth orbit with a burn of 480 seconds at orbital perigee to insert the stack on a "free-return" translunar trajectory. A few minutes later, the Blok G stage is discarded. If something prevents the burn, the crew can try again two orbits later. During the 101-hour coast to the Moon, the Blok D stage is used for two minor mid-course corrections, the first about eight to ten hours after translunar injection and the second about twenty-four hours prior to the start of deceleration as the ship approaches the Moon.

After the approximately four days in coast, during the final approach to the Moon, the Blok D stage fires again for several seconds to reduce velocity of the stack to enter lunar orbit at an altitude of 150 kilometers. On the fourth and fourteenth orbits, the cosmonauts fire the Blok D engine to lower the altitude and insert the combined spacecraft into its operational landing orbit at 100 by twenty kilometers. The crew then checks all systems of the LOK-LK-Blok D stack from the living compartment of the LOK. At this point, the LK is still located inside a cylindrical adapter section, part of the internal fairing of the L3 complex: the commander of the crew then exits the LOK via a hatch in the living compartment wearing the Krechet-94 suit. A mechanical armboom is used to transfer the commander from outside of the orbiter to the fairing outside the lander. Once there, the cosmonaut opens an outer hatch and then an inner one to enter the crew compartment of the LK. The flight engineer of the crew wearing the Orlan spacesuit remains in the depressurized living compartment the entire time of the EVA to assist the commander if necessary.

After the commander checks all the systems in the lander, the LOK and the LK-Blok D combination separate from each other. The adapter sections then open around the LK and separate

60. Marinin and Shamsutdinov, "Soviet Programs for Piloted Flight to the Moon": Afanasyev. "Unknown Spacecraft": Lardier, *L'Astronautique Soviétique*, pp. 167–68.

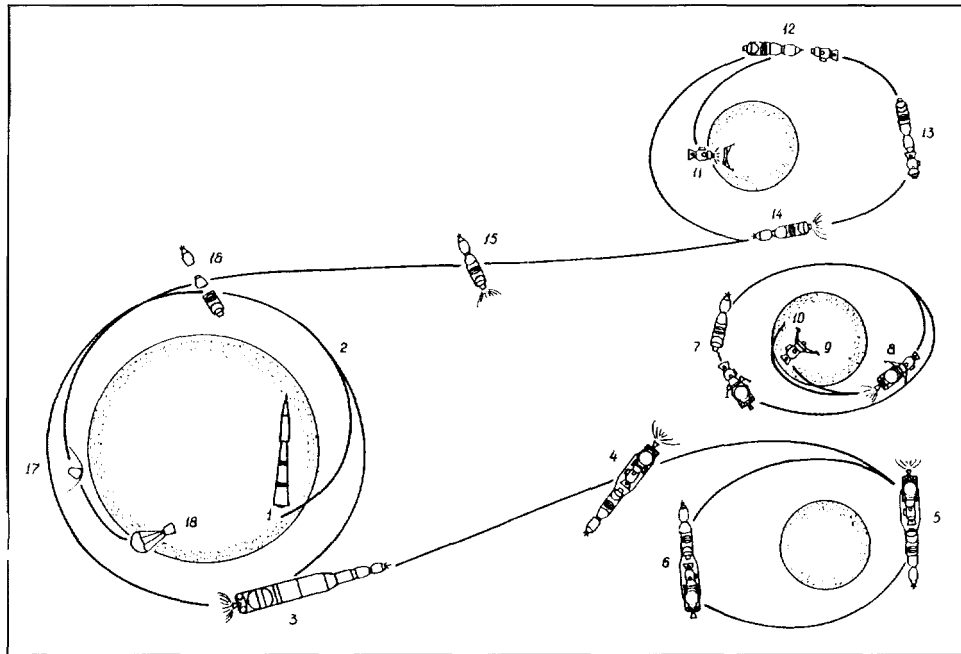

The N1-L3 lunar landing mission profile (1) launch (2) insertion of L3 complex into Earth orbit by three-stage N1 (3) firing of Blok C (fourth) stage for translunar injection jettisoning of Blok C and discarding of lower and median payload fairings over Blok D (4) mid course correction by Blok D (5) lunar orbit insertion by Blok D (6) EVA by commander from the LOK orbiter to the LK lander (7) separation of the LOK from the LK and Blok D combination followed by jettisoning of upper payload fairing over the complex and deployment of lander legs (8) firing of Blok D for initial powered descent from lunar orbit until three kilometers altitude followed by Blok D separation and LK ignition to complete landing (9) exit of commander from LK onto lunar surface with lunar surface time limited to twenty four hours (10) point of impact of spent Blok D stage (11) lunar Takeoff Apparatus liftoff from the Moon (12) lunar orbit insertion for the Lunar Takeoff Apparatus followed by rendezvous operations between the LOK and LK (13) docking of the LOK and Lunar Takeoff Apparatus followed by EVA for commander to transfer from the apparatus to the orbital ship and then the undocking of the two ships (14) LOK main engine firing for trans Earth injection maneuver (15) mid course correction by the LOK (16) separation of the descent apparatus with the two cosmonauts from the rest of the LOK (17) guided descent into Earth's atmosphere and (18) landing of the descent apparatus by parachute onto Soviet territory
(files of Asrf Siddiqi)

from the vehicle, revealing the lander for the first time. At this point, the Blok D stage fires for the last time to begin the landing phase. As a result of a command from the Planeta landing radar, at an altitude of one and a half to two kilometers, the Blok D stage ceases to fire, separates from the LK, and crashes near the landing site. The lander main engine, Blok Ye, then begins to fire, allowing the lander to hover over the landing site, with the engine being manually throttled by the cosmonaut. The commander has about twenty-five seconds to select a landing site and begin terminal descent procedures. The moment the landing pads touch the lunar soil, the four "hold-down" engines on the lander legs ignite to stabilize the lander: the entire time from Blok Ye engine ignition to landing takes one minute. If for some reason the landing fails, the commander has the option of throttling the Blok Ye engine back to full power and reentering lunar orbit to dock with the LOK.

Following landing, the cosmonaut rechecks the lander systems and the Krechet-94 lunar surface suit, depressurizes the LK, and exits through the small oval hatch on the side of the vehicle. A TV camera monitors the descent to the surface along a ladder. The cosmonaut, after

CHALLENGE TO APOLLO

disembarking on the surface, deploys a small set of scientific instruments on the surface, plants the Soviet flag, and takes photographs. The time on the surface is limited from one and a half to six hours. After reentering the spacecraft, the cosmonaut then pressurizes the lander cabin, removes the suit, and begins a rest period. At a predetermined time, the electrical, pneumatic, and mechanical links to the Lunar Landing Aggregate are severed, and the Blok Ye engine refires to lift the Lunar Takeoff Apparatus off the surface and enter a low lunar orbit.

The LOK then takes over the active role and performs a rendezvous using the Kontakt radar scanning system unique to the LOK. The complete rendezvous and docking regime is carried out automatically without the intervention of either the crew or ground control, although the flight engineer in the LOK has the option of taking over manual control. The maneuvering in orbit is carried out by the smaller engine similar to the Soyuz. After docking, the commander reenters the LOK via another EVA, bringing along surface samples. On the thirty-eighth lunar orbit, the docked lander crew cabin is jettisoned. On the following orbit, attitude control thrusters at the base of the LOK are then used to position the vehicle to fire its main Blok I engine on the far side of the Moon to boost itself on a trans-Earth trajectory. The total time in lunar orbit is limited to seventy-seven hours. During the eighty-two-hour coast back, the same engine carries out two mid-course corrections, the first at twenty-four hours and the second at forty-four hours after leaving lunar orbit. Near Earth, about two hours prior to reentry, the LOK separates into its three component parts, and the small descent apparatus with the crew performs a double-skip reentry to reduce velocity and reenters the atmosphere. Parachutes subsequently deploy for a crew landing on Soviet territory."

Above and beyond the technical arcana, the NI-L3 complex was the most visible manifestation of the Soviet Union's response to U.S. President Kennedy's 1961 challenge. It was the mirror image to Apollo-Saturn, a shadow project given birth, designed, and created in complete and utter secrecy, whose only *raison d'être* was to send a Soviet citizen to the Moon before an American. Perhaps in the distant future, Apollo will probably be seen as a representation of the human imperative to explore space and leave the planet—an effort devoid of boundaries and races and cultures. But in the 1960s, both NI-L3 and Apollo were borne of more nationalistic and ideological concerns. These two behemoth projects were the representatives of two countries in a race for technological supremacy. For the Soviets, however, the race to the Moon was not only one to reach the surface of our only natural satellite, but also one to reach its vicinity first. This latter goal, a circumlunar mission, underwent some profound changes in 1965, creating yet another schism in the loosely held conglomerate of the Soviet space industry.

The Birth of the New LI

Chelomey had signed the draft plan for his LK-1 circumlunar spacecraft in mid-1965. A special commission, composed of several subcommittees representing leaders from the government, military, Academy of Sciences, and design bureaus, was then supposed to examine the complete technical plan for the complex and approve further work. Rarely in the piloted space program had a project come to a stop at this late stage, and Chelomey no doubt fully expected to begin producing flight models at this point. Korolev, however, had other plans. Since 1961, he had repeatedly put forward his own piloted circumlunar proposals on an almost annual basis, but all had fallen victim to either political expediency or simply poor planning on the part of Korolev's engineers. Some of these proposals, such as the 7K-9K-11K plan, depended on the use of smaller boosters to achieve their mission. A more pragmatic approach was to use

61. Afanasyev. "Unknown Spacecraft": Marinin and Shamsutdinov. "Soviet Programs for Piloted Flight to the Moon", Harford. Korolev. pp 309-10.

the N1 booster, thus making the circumlunar mission simply a step in the achievement of a lunar landing. Korolev's First Deputy Mishin later recalled:

*S. P. Korolev made repeated attempts to consolidate both our programs [circumlunar and landing] or to at least use the developments of one for the other as much as possible. The first attempt was made in 1961, when he proposed using the N1 (the first version, but with a 75-ton payload mass) for sending two cosmonauts around the Moon. . . He made a second attempt in 1964, when, for that same purpose, he proposed using a rocket consisting of the [N1's] upper rocket stages B, V, and G. . . .*⁶²

Korolev doggedly pursued the latter idea, designated the N11, despite the Soviet government's full sanction of Chelomey's competitive circumlunar project. In retrospect, Korolev's idea seems to have made much more sense, given the exigencies of the Soviet lunar program at the time. Making the circumlunar project a part of the landing would have significantly alleviated the financial burden of moving ahead with two separate, parallel, and unrelated piloted lunar projects—Chelomey's to circle the Moon and Korolev's to land on it.

In January 1965, Korolev and his deputies commenced discussions to coordinate OKB-1's lunar plans. The N1 would launch the L3 to land on the Moon, while the smaller N11 would launch the new L1 spacecraft to circle around the Moon. Although details are still lacking on the L1, it seems to have been a modified Soyuz spacecraft, one designated 7K-PLK, intended exclusively for lunar orbital missions. Depending on the variant chosen, the mass of this new spacecraft would be in the range of 6.8 to 7.7 tons. On February 5, 1965, Korolev signed a preliminary technical prospectus on the L1 lunar *orbital* spacecraft, in anticipation of mounting a last-minute attack on Chelomey's project, which had the more modest goal of *circumlunar* flight. Such was the import given this shoestring effort that by March, Korolev and Mishin were both seriously considering making the L1 the primary thrust of OKB-1 instead of the L3, despite the complete absence of any official support. This effort may have been motivated by news of the "unhappy state of affairs" of Chelomey's program." It seems that Korolev was simply waiting for the most opportune moment to attack his competitor's ambitions. In June 1965, Korolev ordered his deputies to prepare working documentation for the N11-L1 proposal in anticipation of the impending conflict between the two designers.⁶⁴

Between August 5 and 12, 1965, the Interdepartmental Scientific-Technical Council for Space Research conducted a detailed evaluation of Chelomey's LK-1 project. According to a respected Russian historian:

All the subcommissions that reviewed the various sections of the design commended its feasibility and recommended it for implementation following the rectification of individual reproofs. However, the representatives of S. P. Korolev's OKB-1 expressed their dissent, which came down to the fact that the creation, within the OKB-52 [that is, Chelomey's design bureau] of a special vehicle for flying around the Moon was inadvisable, since the Soyuz ship produced in Podlipki [that is, at OKB-1] for the achievement of the same objectives was already in the process of being readied for flight testing."

62 Mishin "Why Didn't We Fly to the Moon?"

63 Semenov ed. *Raketno Kosmicheskaya Korporatsiya* pp 232-33

64 Vetrov interview, September 30 1996

65 Igor Afanasyev "Without the Stamp Secret Circling the Moon Chelomey's Project" (English title) *Krasnaya zvezda* October 28 1995

Korolev's engineers ardently criticized the LK-1 for its limited number of crewmembers, its cramped internal volume, and its poor technical characteristics. In their opinion, many of the concepts used in designing the LK-1, which was Chelomey's first serious foray into piloted space vehicles, were based on half-baked ideas. In Korolev's written testimony at the end of the inspection phase, he alluded to the inability to fulfill deadlines for lunar missions and contended. "The development of a circumlunar vehicle in isolation from the primary objective [of a lunar landing] would be irrational." Thus, flying around the Moon should be "an experimental stage that will make it possible, under field conditions, to perfect the design and the systems of a spacecraft intended for carrying out a [landing] expedition to the Moon."⁶⁶ One of the few factors in Chelomey's favor during this period was the recent first successful orbital launch of the UR-500 booster, the same launcher intended for the circumlunar project.

At this time, Military-Industrial Commission Chairman Smirnov announced that he would preside over a meeting in late August to determine, once and for all, the course of the piloted lunar program. To fortify his position, Korolev prepared a letter to Soviet leader Brezhnev on August 14, which he intended to be the final blow to Chelomey. Speaking of the piloted lunar project, he wrote:

The problem is being solved in both the Soviet Union and the U.S.A. There are the following two stages to the solution of this problem: flying around the Moon with automatic apparatus and crews with the goal of carrying out observations and research of a preliminary character close to the Moon; and the landing of automatic apparatus and manned stations on the surface of the Moon with the goal of the continuous study . . . of the Moon. In our opinion, both these goals can be successfully solved with the NI complex. The NI complex will allow a more complete achievement of the first stage of work — circular flight around the Moon with a crew by creating a heavy artificial satellite of the Moon, carrying the necessary apparatus which would release lunar probes, radio-beacons, etc.[.] to the surface of the Moon. In this case with the first launch of the NI, the crew can be brought into [Earth]orbit with the aid of the well-tested carrier of the R-7 type. The second stage — landing on the surface of the Moon[—]can be accomplished with the aid of one flight of the NI to . . . lunar orbit with the subsequent return of the lunar ship from its surface. The state of work on the NI complex gives hope that within a year we can start flight work of the carrier and lunar system.⁶⁷

Once again, he invoked the Apollo program:

In the U.S.A. work on preparations and accomplishment of landing American astronauts on the Moon . . . has been accepted as a major national priority. The scale of work on the Saturn-Apollo theme with the effective utilization of liquid hydrogen and oxygen and the investment of forces and resources is huge. Judging from the work achieved, the U.S.A. will be able to accomplish a landing on the Moon in 1968.

⁶⁶ *Ibid* That Korolev was personally opposed to Chelomey's LK-1 project is testified in N. P. Kamanin's diaries. His diary entry for August 16 includes the following: "Korolev called me and expressed his dissatisfaction with the fact that Chelomey was beginning to build a spacecraft to fly around the Moon. A long time ago Korolev had expressed the idea of a monopoly on the construction of spacecraft in his Special Design Bureau, and turned to find support on this issue from the military . . . [but] to develop cosmonautics it was useful for spacecraft to be created not by one but several firms." See Kamanin, "In the Future His Name Will Probably Be . . ."

⁶⁷ S. P. Korolev, "Report on the Organization of Work on the NI Carrier" (English title) *Nauka i zhizn* no. 5 (May 1994) 24-26.

Without overestimating the possible successes of the U.S.A. in this sphere, we are extremely alarmed by the unfolding situation and believe that special and urgent measures are necessary for maintaining the leading role of the USSR in space.⁶⁸

At the end of his letter, Korolev recommended four specific courses of action:

1. *Concentrate forces and resources on the primary and main goals: the urgent creation and work on the N1 complex, terminate all work on [Chelomey's]UR-500 theme, and use the released forces and resources on N1.*
2. *Accomplish in 1967 a circular orbit of the Moon with a crew on the upper stages of N1 [that is, the N11] using the well-tested . . . R-7 carrier for delivering the crews to orbit.*
3. *Accomplish in 1968 the first landing of Soviet researchers on the surface of the Moon with the aid of the N1 complex.*
4. *Develop in the nearest future a complex plan of work on the N1 with measures of state importance, ensuring that it has primacy of fulfillment in this work in the agreed upon timeframe⁶⁹*

Notwithstanding the fact that Korolev's proposal was partly motivated to retain his monopoly over the Soviet piloted space program, the letter also made a modicum of sense. It is clear evidence of Soviet, and in particular Korolev's, belief that what was needed was not two different projects, but a singular program to achieve several objectives. Thus, in mid-August 1965, the Soviet Union was poised to set forth on one of two approaches for piloted lunar exploration, one integrated and one fragmented.

Military-Industrial Commission Chairman Smirnov presided over his promised meeting on August 26. The meeting had a formal theme: "On the State of Work on Research into Outer Space, the Moon, and the Planets."⁷⁰ Smirnov did not spare anyone. He criticized almost every facet of the Soviet space program, including the lunar program, interplanetary projects, and Soviet long-range communications systems. Chelomey's OKB-52 was singled out for allowing enormous delays in work on the LK-1 system. OKB-1 and other organizations under the Ministry of General Machine Building were not excluded from this censure, being accused of "weakness of work." To Korolev's dismay, Smirnov believed that Chelomey's UR-500K booster should play a central role in the future of the human space effort. In conclusion, Smirnov issued three orders to the Ministry and its subordinate organizations:

- To prepare in a week's time a schedule for the manufacture and work on the UR-500K launcher
- To Korolev and Chelomey, to examine and solve the problem of unifying the development of a circumlunar vehicle and a lunar landing spacecraft
- To submit in a month's time a program for flight testing the UR-500K and piloted spaceships"

As a result of Smirnov's orders, Minister of General Machine Building Afanasyev established yet another "working commission" to examine the state of work on lunar programs at

68 *Ibid*

69 *Ibid* Author's emphasis

70 Semenov ed *Raketno-Kosmicheskaya Korporatsiya* p 233

71 *Ibid*

both the Chelomey and Korolev design bureaus." On September 6 and 7, the commission visited both enterprises. Commission members had already been given all seventy-eight volumes of the LK-1 draft plan to familiarize themselves with the project's technical details. What they found was not surprising in the light of Korolev's earlier criticisms of Chelomey's work—that is, that the LK-1 circumlunar program was beset by delays in the creation of the launch vehicle, its Blok A TLI stage, and the LK-1 spaceship itself. Chelomey's deputies displayed wooden models of the LK-1 and Blok A, but the criticism from the Korolev faction was relentless. Chelomey's poor showing was in complete contrast to the favorable impression of the following day, when the commission visited Kaliningrad to see Korolev's handiwork. Korolev's engineers proudly displayed at least ten metal models of the 7K Soyuz at the OKB-1 plant as dozens of technicians worked around them in a professional manner. The commission was particularly impressed by the success of work on the critical Blok D stage of the L3 lunar landing complex. Ultimately, there were "long and heated discussions," which ended in "both sides [Chelomey and Korolev] blaming each other." but the end result was clear: Chelomey's LK-1 program was effectively dead after more than a year's expenditure of time, resources, and funding." Chelomey desperately tried to defend his product, appealing directly to Academy of Sciences President Keldysh, but it was too little too late.⁷⁴ As Mishin recalled later, even the government sided against Chelomey:

In the second half of 1965, it became clear that the collective of the OKB headed by V N. Chelomey would not be able to ensure that our country would be first place in achieving manned circumlunar flight, because the work was lagging in the development of the circumlunar flight system."

It was time for yet another abrupt turn in the Soviet piloted space program.

The concerted opposition to the LK-1 effort cleared the way to address Military-Industrial Commission Chairman Smirnov's orders from late August. It was clear to the major participants that while the LK-1 was not an option worth pursuing, Chelomey's UR-500K should be a major component of any future lunar plan. This meant that Korolev's N11 proposal was going to be rejected. At the same time, with the LK-1 out of the running, the only remaining option was to use the more capable L1 based on the Soyuz spacecraft. The combination of the UR-500K and the L1 would provide a solution to the near deadlock. Korolev, pragmatic to the end, had already anticipated this exact course of events even before the death knell of the LK-1. As early as the first days of August, Korolev's engineers were exploring contingency plans. One of the first options was to use the N1's Blok G and Blok D stages as upper stages of the

⁷² This commission included among others S A Afanasyev (Minister of MOM) M V Keldysh (President of AN SSSR) C A Tyulin (First Deputy Minister of MOM) C N Pashkov (Deputy Chairman of VPK) K A Kerimov (Chief of the Third Chief Directorate of MOM) and Yu A Mozzhorin (Director of NII 88) as well several chief and general designers including V P Barmin (CSKB SpetsMash) V N Chelomey (OKB 52) S P Korolev (OKB 1) N D Kuznetsov (OKB 276) V I Kuznetsov (NII 944) N A Pilyugin (NII AP) and M S Ryazanskiy (NII Priborostroyeniya) See Ivan Evteyev "From the History of the Development of Space" (English title) *Tribun* July 2 1993 p 3

⁷³ The quotes are from Mishin "Why Didn't We Fly to the Moon?"

⁷⁴ What seems to be descriptions of the visits in early September 1965 are included in Mikhail Rudenko "Space Bulletin Lunar Attraction Historical Chronicles First Publication" (English title) *Vozdushnyy transport* 26 (1993) 8-9 although the dates given for the visits are September 1 and 9 See also Semenov ed *Raketno Kosmicheskaya Korporatsiya* pp 233-34 in which this process is said to have taken place in September or October Another source suggests that the commission's visits to the two design bureaus took place in late August 1965 See Evteyev "From the History of the Development of Space"

⁷⁵ Mishin "Why Didn't We Fly to the Moon?"

UR-500K to boost the L1 spacecraft into lunar orbit.⁷⁶ By mid-September, there were two competitive circumlunar variants for the UR-500K, each with a different TLI stage: either Korolev's Blok D or Chelomey's Blok A. Both options would mean dramatically reducing the mass of the L1 spacecraft, down to four and a half to five and a half tons. Thus, the original conception of the L1 spacecraft, as the lunar-orbiting 7K-LPK, was shelved. To reduce the mass of the Soyuz spacecraft to an absolute minimum, Korolev's engineers emerged with a surprising design solution: they eliminated the spheroid living compartment from the forward end of the spaceship. As such, the two-person crew would have to spend their entire mission cramped in the small descent apparatus. This modified spacecraft inherited the general L1 designation: denoting its lineage back to the 7K Soyuz was its design designation, the 7K-L1. The mission would be only circumlunar.⁷⁷

A second issue of concern was whether to allow crews to be launched on the UR-500K booster because it used toxic propellants extremely dangerous when exposed to humans. OKB-1 thus explored alternative variants in which the crew would be launched into orbit on a standard Soyuz booster, link up with the L1 spacecraft, transfer to the L1 by an EVA, and then leave for circumlunar space in the L1. By October 5, at a meeting of high ministry officials, it seems that the direct launch version was favored despite the concerns for safety. During the following week, chief designers representing each major aspect of the new L1 plan drew up a formal proposal for submission to the Military-Industrial Commission.⁷⁸ Based on this proposal, the Central Committee of the Communist Party and the USSR Council of Ministers issued a joint decree on October 25, 1965, titled "On Concentrating the Forces of Design Organizations of the Industry for the Creation of the Means of a Rocket-Space Complex for Circling the Moon."⁷⁹ This document cut through the confusion inherent in the lunar program and effectively ratified a piloted circumlunar project separate from the landing effort with the following three provisions:

- Korolev's OKB-1 would be "brought in" to the piloted circumlunar program, which would use Chelomey's UR-500K booster.
- Chelomey's OKB-52 would terminate all work on its LK-1 spacecraft and instead concentrate all resources in accelerating the UR-500K booster program, as well as its TLI stage (Blok A).
- OKB-1 would concentrate its resources on the design and creation of new piloted spaceship for circumlunar flight, as well as a second TLI stage for use with the UR-500K booster.

Among the many repercussions of this decision, the most important was clearly the continued separation of the circumlunar and landing programs. Korolev's pleas in the first half of 1965 had provided the climate to integrate the two disparate projects, but despite intensive discussions, arguments, and even compromises, the ultimate direction adopted left the programs fairly independent. It was as if NASA had decided on two parallel projects—one using the Saturn IB for circumlunar missions with a modified Apollo and one using the Saturn V for land-

76 As early as 1964 Korolev had evidently proposed using the IIA57 Voskhod booster's Blok I third stage on Chelomey's UR-500K Proton as a TLI stage. Chelomey refused the offer. See B. Ye. Chertok, *Rakety i lyudi goryachiye dni kholodnoy voyny* (Moscow: Mashinostroyeniye, 1997), pp. 387–88; Golovanov, *Korolev*, p. 754.

77 Korolev may have first introduced his 7K-L1 variant publicly on September 8, 1965. See V. Petrakov and I. Afanasyev, "Proton: Passion" (English title), *Aviatsiya i kosmonavtika* no. 4 (April 1993): 10–12.

78 The seven signatories to the proposal were S. P. Korolev (Chief Designer of OKB-1), V. N. Chelomey (General Designer of OKB-52), N. A. Pilyugin (Director and Chief Designer of NII AP), M. S. Ryazanskiy (Chief Designer of NII Priborostroyeniya), V. A. Khrustalev (Chief Designer of TsKB 589), A. M. Isayev (Chief Designer of OKB-2), and V. P. Barmin (Chief Designer of GSKB SpetsMash). See Semenov, ed., *Raketno-Kosmicheskaya Korporatsiya*, p. 234.

79 *Ibid.*

ing missions with a completely different spacecraft. A closer look at this decision reveals some semblance of a rationale. First, for the Soviets, "before the end of the decade" was an unimportant abstraction. Far more important to them was the impending celebration of the fiftieth anniversary of the Great October Revolution, set for the first week of November 1967. Anniversaries played a far more important role in Soviet culture than, for example, in the American cultural milieu. All Soviet industrial and economic enterprises were obliged to "present" the Communist Party with a "gift" as part of major celebrations. Korolev's OKB-1 was not exempt from this unwritten rule. Anticipating that a lunar landing as early as 1967 was a foregone impossibility, the major space chief designers instead opted to choose a lesser ambitious goal, a circumlunar flight. Second, the circumlunar project would allow the Soviets to test a few components of the landing system. Engineers would gain experience in deep space piloted missions, high-speed reentry, long-range communications, and the flying of a stripped-down Soyuz spacecraft to lunar distances.

In accordance with the decree, the Ministry of General Machine Building formalized the new direction of the lunar program with an order on November 13, 1965, specifying manufacturing quantities and schedules for the project. The several design organizations together were to build and deliver six and nine complete spacecraft complexes in 1966 and 1967, respectively. Each complex would consist of the spacecraft proper, designated the 7K-L1 (or "product 11F91"), a TLI stage, and the UR-500K launch vehicle. In addition, these organizations would also produce several 7K-OK Earth-orbital Soyuz spacecraft and its 11A511 launch vehicle for the delivery of lunar crews to Earth orbit in case the direct flight on Chelomey's booster was not deemed safe at some future point.⁸⁰ Minister Afanasyev's order called on Korolev and Chelomey to finish, by November 25, specifications of the complete system with two different possible variants—one using Korolev's Blok D and the other using Chelomey's Blok A—as the TLI stage. The same order from Afanasyev also confirmed contractors for the major subsystems of the 7K-L1 spaceship, in particular its guidance and control systems."

The 7K-L1's guidance system became the source of a conflict that was characterized by the pitfalls of personal allegiances, in particular Korolev's relationship with Chief Designer Nikolay A. Pilyugin, the man who had led the design of almost all Soviet guidance systems for missiles. Pilyugin had been one of the original members of the Council of Chief Designers in the 1940s. Pictures of him from Kapustin Yar show a man looking slightly older than his age, with a dour face, dark eyes, and a world-weary disposition. Following his return from Germany in February 1947, Pilyugin had joined NII-885 in Moscow as a deputy to Chief Designer Ryazanskiy; a year later, he was appointed a chief designer at the institute's Department No. 3, responsible for inertial guidance systems. Of all the other chief designers, it was perhaps Pilyugin who was the closest to Korolev. While Korolev had suffered from the Purges in the 1930s, Pilyugin himself was the target of Beriya's terrifying whims during the early 1950s. Once, after a particularly galling series of failures in the guidance system of a missile, Beriya hounded Pilyugin into admitting sabotage. When Pilyugin argued back, he was convinced that it was the end for him. There were other factors playing against the chief designer: the "not from workers" background of his wife, the arrest of his brother, and his father-in-law's profession." It was only after Beriya's death that Pilyugin breathed easier.

80. The second test launch of the two-stage UR-500 booster was completely successful on November 2, 1965, no doubt bolstering the case in favor of using a direct flight.

81. Semenov, ed., *Raketno-Kosmicheskaya Korporatsiya*, p. 234.

82. Col. M. Rebrov, "A Day Before the Launch . . . Pages From the Life of the Chief Designer of Rocket-Space Guidance Systems" (English title), *Krasnaya zvezda*, February 25, 1989, p. 4; Lt.-Gen. G. Tyulin, "Look Forward" (English title) *Krasnaya zvezda*, May 18, 1988, p. 4; B. Ye. Chertok, *Rakety i lyudi* (Moscow: Mashinostroyeniye, 1994), p. 333.

Despite chronic diabetes and a chain-smoking habit. Pilyugin flourished during the 1950s. He retained a near monopoly on the development of inertial guidance systems for Soviet strategic missiles, slowly rising in power until, by the early 1960s, his design department at NII-885 had outgrown the thematic direction of the organization, which was still headed by Chief Designer Ryazanskiy. To circumvent any potential conflict between the two, in April 1963, Pilyugin's Complex No. 1 at the institute separated and became the new Scientific-Research Institute for Automation and Instrument Building (NII AP)." As the conflict over the NI broke into the open, when Glushko, Barmin, and Kuznetsov of the original six "defected" to Chelomey's side, it was Pilyugin who remained by Korolev, perhaps playing a critical role in the entire project's genesis.

In general, throughout the 1960s, Pilyugin found himself less and less interested in guidance systems for spacecraft, instead preferring to focus on ballistic missiles or launch vehicles, such as the NI. When design of the Soyuz had begun in 1962, Pilyugin did not participate. Similarly, when early conceptions of the LI were discussed in early 1965, Pilyugin's lack of interest prompted Korolev to entrust the design of the ship's guidance system to his own talented guidance systems specialist, Raushenbakh. As the LI project picked up steam, however, Pilyugin abruptly changed his mind and insisted that his institute be picked as the contractor. Pilyugin's proposal for the system was heavier and more cumbersome and drained more power than Raushenbakh's. Korolev's people warned that choosing Pilyugin's system would delay the project by two, perhaps three, years."

Korolev was caught in a bind. OKB-1 engineer Feoktistov sat down with Pilyugin's representatives and explained in detail why their proposal would hinder the LI program. Pilyugin called up Korolev in rage at Feoktistov's "improper" behavior. Korolev was well aware that things had changed since the 1950s, when the concept of what was "best" for a particular project overruled personal allegiances. Put on the spot, Korolev explained to his deputies that if he did not choose Pilyugin, it would be a breach of their personal contract, an unspoken agreement forged over twenty years. In September 1965, Korolev selected Pilyugin's heavier and more cumbersome design for the 7K-LI: OKB-1 would retain the responsibility of the general layout of the system. Thus, yet another technical decision in the lunar program was pushed through on the basis of nontechnical considerations. The decision to forge ahead with Pilyugin was specified in the November order from the Ministry of General Machine Building on the design of 7K-LI spacecraft. Three primary organizations would participate in the development of the vehicle:



Chief Designer Pilyugin developed inertial guidance systems for most Soviet ballistic missiles and launch vehicles. Of all the original members of the famous Council of Chief Designers, Pilyugin was perhaps the closest to Sergey Korolev. The two had met in Germany in 1945 during the A-4 recovery operations (files of Peter Gorin)

83 S. M. Vyazov "18 May—80 Years From the Birth of Academician N. A. Pilyugin (1908)" (English title) *Iz istorii aviatsii i kosmonavтики* 59 (1988) 38-46
84 Colovanov *Korolev* pp 754-56

- Korolev's OKB-1 (general layout of the guidance system, systems for orientation, approach, power sources, on-board cable networks, manual approach guidance, thermo-regulation, and on-board switchboards)
- Pilyugin's NII AP (stabilization system for issuing course corrections, control systems for engines, guidance system for reentry, stabilization and guidance systems for engines of the TLI stage, general layout and logic for guidance for the TLI stage, and on-board switchboard for the TLI stage)
- Ryazanskiy's Scientific-Research Institute for Instrument Building (radio complexes with systems for trajectory measurement, telemetry, communications, transmission of TV images during all stages of the flight, and electronic programmed timers)⁸⁵

Throughout November 1965, there was intensive collaboration among all the major organizations to eliminate each and every potential source of uncertainty in the program. The most important decision at this point was whether to use Chelomey's Blok A or Korolev's Blok D as a TLI stage. A combined group of engineers from OKB-1 and OKB-52 worked on this particular problem at the time and recommended the use of Blok D because it would have better performance characteristics in combination with the UR-500K booster. There was an additional rationale for favoring Blok D. This same stage was to fly as part of the N 1-13 and perform some of the most critical maneuvers during a lunar landing. By flying it earlier as part of the circumlunar program, the engineers would be able to eliminate all problems prior to a landing.⁸⁶

On November 30, OKB-1 and OKB-52 issued the predraft plan for the LI program. Within a quick two weeks, on December 13, two documents were signed, finalizing the detailed layout and technical components of the piloted circumlunar program. The first of these, "Preliminary Data on the 7K-LI Ship," was signed by Korolev and addressed the piloted spacecraft itself. The second, a protocol of understanding between the two major parties titled "The Basic Composition of the UR-500-7K-LI Rocket-Space Complex," was signed by both Korolev and Chelomey and formally approved Blok D as an integral part of the entire project." Two days later, Korolev presented this final conception to the Military-Industrial Commission as well as the Council of Chief Designers." It had been less than four months since the commission's original directive to bring some order to the effort, but a concerted effort had managed to bring some sorely needed guidance to the program. For Korolev, it was a victory of sorts; after five tries since 1961, he had finally managed to gain control over the circumlunar program.⁸⁷

The irony of the matter was that the compromise solution in the form of the UR-500K-LI project was probably not the most effective path available. There was a brief window of opportunity in mid-1965 when Korolev had taken advantage of Chelomey's shortcomings to suggest unifying both the landing and circumlunar programs as one. But by the end of 1965, political expediency in the need to demonstrate Soviet supremacy in space by the fiftieth anniversary of the Great October Revolution in 1967 had closed that opportunity. The two programs remained

85. Semenov, ed. *Raketno-Kosmicheskaya Korporatsiya*, p. 234

86. One of the advantages of using Blok D was a slightly better mass performance. In this new profile, the third stage of the UR-500K booster would not enter orbit. Blok D (the fourth stage) itself would fire to achieve orbital velocity around Earth. Its second firing would be the TLI boost. This profile, the engineers calculated, would allow a 100-kilogram increase in the mass of the 7K-LI, a significant amount given the limited capability of the entire system. See *ibid.*, p. 235.

87. A third document, dated December 31, 1965, and titled "Preliminary Data on the LI Payload Block (Product I 15824)," was a more detailed appraisal of the project. See *ibid.*, pp. 234-35.

88. Afanasyev, "Unknown Spacecraft": I. A. Marinin and S. Kh. Shamsutdinov, "Soviet Programs for Lunar Flights" (English title), *Zemlya i usemennaya* no. 4 (July-August 1993): 62-69

89. The four previous proposals were an NI-related proposal in 1961, the Vostok-7/IL project in 1962, the 7K-9K-11K proposal in 1963, and the NII-LI idea in 1964-65

separate, with independent goals, different launch vehicles, ground systems, and spacecraft. but using the same design bureaus that were already overburdened and stretched to the limit.

More Voskhods?

The three long-range piloted projects that gained a modicum of focus in 1965—the Earth-orbital Soyuz program, the circumlunar L1 project, and the lunar landing NI-L3 effort—comprised only a portion of OKB-1's efforts during the year. Through the unending meetings and decisions on these projects, Korolev's engineers were concurrently engaged in numerous other programs, such as the Molniya-1 communications satellite, the Luna automated lunar probe, the Mars and Venera spacecraft to the inner planets, the Zenit-2 and Zenit-4 robotic military reconnaissance satellites, the R-5V suborbital rocket, and at least three military ballistic missiles. In the piloted program, the most immediate concern was how to follow up the spectacular Voskhod 2 flight of Belyayev and Leonov in March 1965. The earliest expected date for missions in any of the three long-range piloted programs would be 1966. Thus OKB-1 anticipated at least a yearlong period before the resumption of Soviet crewed spaceflights. To fill this gap, there were a plethora of plans to use the near-obsolete 3KV-type Voskhod spacecraft to mount a few additional missions.

Planning for subsequent missions to Voskhod 2 had begun well before that flight and in fact trace back to the earlier "extended Vostok" missions, which were abandoned in early 1964 once the Voskhod program got its start. As early as September 1964, the Air Force was planning for the construction of five more Voskhods by early 1965, two for flights with one cosmonaut of twelve to fifteen days, two for "special scientific experiments," and one for a repeat EVA mission. By February 1965, OKB-1 issued a document, "Initial Data on the 'Voskhod' (3KV and 3KD) Ship Series in 1965," which was a slightly revised manifest for five manufactured spaceships:

Vehicle	Launch Date	Mission
3KV no. 5	July–August 1965	Two dogs on a fifteen- to thirty-day mission
3KV no. 6 Voskhod 3	September–October 1965	Pilot and scientist on a fifteen-day mission with an experiment in artificial gravity
3KV no. 7 Voskhod 4	March–April 1966	Pilot and doctor on a fifteen- to eighteen-day mission with an experiment in artificial gravity for three to four days
3KD no. 8 Voskhod 5	1966	Two-person crew on three- to five-day mission with an EVA to a distance of fifty to 100 meters
3KD no. 9 Voskhod 6	1966	Two-person crew on three- to five-day mission with an EVA to a distance of fifty to 100 meters ⁹⁰

The Military-Industrial Commission gave this manifest and schedule official status by formal decree (no. 156), dated July 28, 1965, and titled "On the Manufacture of 'Voskhod' Space Satellite-Ships." The resolution obligated various branches of the space industry conclusively

90 Kamanin *Skrytiy kosmos 1964–1966* pp 110 138–39, 156–57

to confirm within a month's time the full range of scientific and military experiments to be conducted on the five missions, as well as schedules for the manufacture of necessary supplementary equipment.⁹¹

Five Air Force cosmonauts began training for the first piloted mission (Voskhod 3) in early March 1965. At Korolev's insistence, a sixth man, Dr. Georgiy P. Katys, a civilian laboratory chief at the Institute of Telemechanics and Automation of the Academy of Sciences, was added to the training group. Katys had been a leading contender for the "scientist" position on the first Voskhod mission in 1964, but he had instead served as a backup, primarily because of Korolev's stubborn insistence on having Feoktistov on the flight. Having been excluded from that crew, Katys persevered, and throughout the following months, prepared an extensive scientific program for implementation on a future Voskhod mission. In April, he joined the five military officers to train for Voskhod 3. It would be the first time that a career scientist would fly into space."

The flight program for Voskhod 3, prepared with the participation of Katys, was designed to extend the absolute duration for a piloted spaceflight. Some of mission's scientific instrumentation would be mounted in a special semi-spherical pressurized chamber curved inward into the crew capsule, while others would be installed on the exterior of the 3KV ship for work in conditions of vacuum." Apart from scientific and military experiments, the crew would carry out the entire flight in a highly elliptical orbit, thereby raising the absolute altitude record for a piloted spaceship. As with the previous two Voskhod missions, Voskhod 3 would be preceded by a precursor flight, this one with dogs aboard, which would be a complete test of the life support systems of the spacecraft, clearly one of the weakest elements in the Voskhod spacecraft. During the one-day Voskhod and Voskhod 2 missions, failures and malfunctions in the system raised grave concern among many on the capacity of the vehicle to carry out longer duration missions.

There was another ambitious element originally planned for both Voskhod 3 and Voskhod 4: the simulation of artificial gravity in Earth orbit. In late 1964, Korolev had asked Raushenbakh, chief of OKB-1's Department No. 27, to begin work on a modest system to test an artificial gravity system in low-Earth orbit. The project was named IT, the Russian abbreviation for "artificial gravity." Raushenbakh's plan called for the launch of a 3KV Voskhod craft aboard the IAS7 launcher into a low-Earth orbit. Following insertion into orbit, the 6,370-kilogram Voskhod craft carrying two cosmonauts would separate from the 30,000-kilogram upper stage to a distance of about five to ten meters to deploy a tether. At this point, a solid-fuel engine would fire to separate the two vehicles to completely unwind the tether to its maximum length of more than 1,000 meters. When it was completely unwound, the two craft would slowly begin to rotate around a common axis, initially at about one and a half degrees per second. One peripheral objective of the IT project was to generate an electrical current from interactions of the current-conducting tether with Earth's geomagnetic field. In an interesting connection with the human lunar landing program, Korolev and Raushenbakh also planned to simulate one-sixth the level of Earth's gravity in space. After the initial phase of rotation, the crew would reduce the distance between the ship and the upper stage to 300 meters, increasing the

91 *Ibid* p 207

92 *Ibid* pp 159 177-78 183-84 Kamanin "In the Future His Name Will Probably Be ..." I Marinin "Russian Cosmonaut Scholars" (English title) *Novosti kosmonautiki* 3 (January 28-February 11 1996) 49-54 The six men formed three tentative crews for Voskhod 3 B V Volynov/G P Katys (primary) G T Beregovoy/L S Demin (backup) and V A Shatalov/Yu P Artyukhin (backup)

93 S Shamsutdinov and I Marinin "Flights Which Never Happened" (English title) *Aviatsiya i kosmonautika* no 1 (January 1993) 44-45

angular velocity to about seven degrees per second. The tether would then be disconnected, and the crew would continue their planned mission in orbit. According to Raushenbakh's design, the actual tether would be strapped to the side of the Voskhod spacecraft from the base of the reserve retrorocket unit all the way to the apex of the primary deorbit engine. Total time in a tethered mode could be extended up to one or two days." Although the design of the system originated at OKB-1, it seems that responsibility for developing an actual working prototype was turned over to OKB-1 Branch No. 3 at Kuybyshev, whose primary responsibility at the time was the manufacture of launch vehicles and the design of reconnaissance satellites."

The Voskhod 4 mission would primarily focus on biological and medical experiments in Earth orbit. By early March 1965, three senior physicians at the Air Force's Institute of Aviation and Space Medicine had prepared an extensive program of medical research for the mission. This included carrying out surgery in space using a rabbit as a test subject (from Yaroshenko), a psychological experiments program (from Ivanov), and a cardiovascular research program (from Voskresenskiy) that would include studying the effects of calisthenics in space. On February 10, 1965, two doctors who had served as backups during the first Voskhod mission, Colonel Lazarev and Captain Sorokin, began preparations for the doctor position on the flight. Despite resistance from the Air Force, the Ministry of Health also managed to put forward several candidates from its in-house Institute of Biomedical Problems for the mission. In May, four doctors passed initial medical tests at the Central Military Scientific-Research Hospital in Moscow, and two of them joined Lazarev and Sorokin in September 1965 to train for the medical flight. Although none of the doctors were formally inducted into the cosmonaut team, they represented the biomedical profession in a first serious attempt to include complex physiological research as part of the Soviet piloted space effort.⁹⁶

One of the later Voskhods would be another exercise in propaganda. As early as January 1965, cosmonaut overseer Kamanin was thinking of having two women fly on a future Voskhod spacecraft, with one of them carrying out a spacewalk. On April 2, 1965, during a meeting with Korolev, Kamanin casually mentioned his idea to the chief designer. The proposal must have seemed like *déjà vu* to Korolev, for it was the same Kamanin who had suggested a female space mission in 1961, which eventually led to Tereshkova's flight. Kamanin wrote in his journal that he:

was motivated to make this suggestion because a spacewalk by a woman, with a wide range of studies, and possibly with the use of autonomous means of movement in space, would have no less a response from the world than the flight of Voskhod-2.⁹⁷

Korolev wanted nothing to do with it, while the male cosmonauts were quite vocally against it. But within two weeks, Kamanin had evidently managed to gain the support of key officials, including Academy of Sciences President Keldysh and Air Force Commander-in-Chief

94 Mikhail Rebrov "IT Project" (English title) *Krasnaya zvezda* June 8 1993 p 2 G A Kustova ed *Ot peruogo Sputnika do 'Energii' "Burana" i "Mira"* (Kaliningrad RKK Energiya 1994) p 57 Note that the length of the tether is described as being fifty meters in one source. It is possible that this was the early version of the system to be flown on Voskhod 3. See Shamsutdinov and Marinin "Flights Which Never Happened."

95 Shamsutdinov and Marinin "Flights Which Never Happened"

96 *Ibid.* V Semenov I Marinin and S Shamsutdinov *Iz istorii kosmonautiki: uypusk II nabory v otryady kosmonavtov i astronautov* (Moscow AO Videokosmos 1995) pp 21-24 Kamanin *Skrytiy kosmos 1964-1966* pp 139-226-227 The original four candidates from the Ministry of Health were Ye A Ilin A A Kisilev S O Nikolayev and Yu A Senkevich. Nikolayev and Senkevich were dropped from training at an early stage, leaving only Ilin and Kisilev.

97 Kamanin *Skrytiy kosmos 1964-1966* p 178

Vershinin. After Tereshkova's flight, the other four female cosmonauts had for all intents and purposes been assigned to support roles, but Kamanin's new idea brought them back into the forefront again. In April 1965, two of the most qualified of the remaining four. Ponomareva and Solovyeva, began training for the EVA mission of Voskhod 5. Solovyeva would have the honor of becoming the first woman to walk in space. Four men would serve as backups.⁹⁸

Another component of the continuing Voskhod program was the use of the first Soviet autonomous EVA maneuvering backpack, designated the Cosmonaut Maneuvering and Motion Unit (UPMK). Briefly considered for use by the women cosmonauts, engineers delayed its use on a later mission by more experienced pilots. The white horseshoe-shaped unit had an empty mass of ninety kilograms and was designed like a motor scooter. The UPMK, which had an autonomous lifetime of four hours, was equipped with eighteen solid rocket motors for forward and reverse movement, as well as fourteen compressed air thrusters for angular movement (with six degrees of freedom). Maximum capable velocity relative to Voskhod was projected at thirty two kilometers per hour. The cosmonaut would wear the unit around the waist and control movement via two pistol-shaped handgrips and a control panel. Total mass with a cosmonaut wearing the *Berkut* EVA suit was approximately 250 kilograms. Severin's Plant No. 918 began developing the UPMK in 1964. At least four cosmonauts—Corbatko, Khrunov, Shonin, and Zaykin—were in the running for the mission by September 1965. Khrunov, who had served as backup to Leonov on Voskhod 2, was the favorite for the actual EVA.⁹⁹

One similar project that may have been related to the Voskhod program was the development of an "individual means of cosmonaut descent from orbit to Earth." Engineers apparently began research at the time on "a spacesuit-capsule with the capability to perform descent and soft-landing by a single person."¹⁰⁰ In August 1965, Plant No. 918 summarized its research on this unique capsule in two variants: for one cosmonaut (500 kilograms mass) and for two cosmonauts (700 kilograms mass). As with the UPMK, the capsule would be capable of inspecting spacecraft, rescuing cosmonauts, and recovering parts of orbiting vehicles.¹⁰¹

These were all fairly ambitious plans for the limited Voskhod spacecraft, and their successful implementation would certainly have produced a significant impact on the already awed public perception of the Soviet space program. The period following the Voskhod 2 mission was, however, a time of great indecision. There were continuing clashes between Korolev and the Ministry of Defense, which through the Air Force and the Strategic Missile Forces had operational control of the space program. The chief designer had always been resentful of the Air Force's complete jurisdiction over the training and selection of cosmonaut crews. This issue was aggravated by an order from Military-Industrial Commission Chairman Smirnov in early August 1965 to "immediately begin military research on Voskhod spacecraft."¹⁰² Apparently prompted by concerns over the "militarization" of space by the United States, the order led the

98 Ibid pp 124 178 182-83 The Voskhod 5 crews were named by Kamanin on April 14 1965 The backups for V L Ponomareva and I B Solovyeva were D A Zaykin/Ye V Khrunov and G S Shonin/V V Gorbatko

99 Ibid pp 226-27 Neville Kidger "The Soviet Space Back Pack" *Spaceflight* 34 (March 1992) 82-83

100 Ishlinskiy ed *Akademiya S P Korolev* pp 210-11

101 Kamanin *Skrytiy kosmos 1964-1966* pp 208 244-45

102 K Lantratov "Dmitriy Kozlov's Zvezda" (English title) *Novosti kosmonavtiki* 3 (January 27-February 9 1997) 50-55 Kamanin "In the Future His Name Will Probably Be ..." During this period there had also been some discussion concerning the possible installation of orbit correction engines aboard the 3KV Voskhod which would have been a qualitative leap in abilities. Proposals were circulated among Korolev Kamanin and Soviet Air Force Commander in Chief Marshal K A Vershinin to this effect although Korolev was apparently hesitant to approve such a plan because the installation of such engines could delay the program. It was however obvious that any advanced military reconnaissance mission would be limited by the lack of engines for changing altitude and inclination. The changes to the Voskhod were never enacted.

Air Force to constantly change the manifest for succeeding Voskhod missions. For example, by late August, the Air Force wanted to fly a one-man twenty-five-day mission on Voskhod 4 with only military experiments instead of the original fifteen-day biological research flight. The Air Force planned to use high-quality Czech-built cameras named *Admira* for the mission. Korolev was outraged at the revision, threatening once again to remove control over cosmonaut training and crewing from the Air Force.

The single-man Air Force plan was eventually rejected, but by late November, Kamanin removed scientist Katys from the primary crew of Voskhod 3 because another military cosmonaut was "much better prepared for a 20-day flight."¹⁰³ When he heard the news, Korolev told Kamanin: "The Air Force is continuing its policy of removing civilian cosmonauts from flights. That's the way it was in the preparation for the Voskhod-1 flight, and that's how it's continuing now. I'm tired of the behavior of the military. . . ."¹⁰⁴ Kamanin wrote in his journal:

*Korolev frequently stoops to trivialities, harasses and irritates people, interferes with details and neglects the key thing: time and the quality of preparation of the spacecraft. He spreads himself too thin and tries to keep everything under his control: this explains his continual conflicts with Glushko, Pilyugin, Voronin, Kosberg, and other Chief Designers. Korolev even tries to influence the activity of the Air Force.*¹⁰⁵

The debates within the upper echelons of the Soviet space program over Voskhod reflected, on a larger level, the conflicts between the defense and civilian sectors in the arena of spaceflight. Clearly, the inherent confusion had a debilitating effect on the entire program. Trying to pander to the military while staying faithful to his own schematic for space exploration, Korolev found himself in a difficult position, often making decisions that were too reductive and counterproductive than one would expect from a visionary manager of his stature. As the months in 1965 wore on, the government added to the confusion by not laying down deadlines for specific missions—actions that would have helped clear the way for launching the remaining Voskhods.

The inevitable delays appeared again. Originally, Korolev had set the ten- to fifteen-day Voskhod 3 flight for November 1965, but it was clear by early September that this was unrealistic. A flightworthy spacecraft would not be ready until at least January of the following year, although the crew was prepared to fly. One of the primary bottlenecks was the development of a reliable life support system. The original Vostok system had been designed to support one pilot for a maximum of ten days. Voskhod would have to maintain two pilots in orbit for more than two weeks. The artificial gravity experiment, meanwhile, was rescheduled. During a technical conference in October 1965 to discuss the status of the project, Korolev decided to delay the system's testing from Voskhod 3 to Voskhod 4. The schedule for the project was incredibly compressed, and as one participant recalled, "when the production of the artificial gravity system began, of course, there were extensive delays. Also, many of the technical questions in the project's planning section could not be solved."¹⁰⁶ There was also external pressure. In August 1965, the United States had finally taken the absolute endurance record in space with the Gemini V mission, which lasted nearly a week. There were plans to fly Gemini VII in December for two whole weeks. In a desperate measure, Korolev extended Voskhod 3's planned duration from ten

¹⁰³ Kamanin, "In the Future His Name Will Probably Be . . ." Kamanin *Skrytiy kosmos* 1964–1966 p. 265. Katys was replaced by V. V. Corbatko, one of the original twenty cosmonauts from the 1960 selection. B. V. Volynov remained the primary commander of the Voskhod 3 mission.

¹⁰⁴ Kamanin, "In the Future His Name Will Probably Be . . ." p. 30.

¹⁰⁵ *Ibid.*

¹⁰⁶ Ishlinskiy, ed. *Akademiik 5 P Korolev* p. 336. Rebrov, "IT Project."

to fifteen days to twenty days. There were also delays in the female Voskhod 5 mission. Not only were the female cosmonauts receiving inadequate training, but Plant No. 918 refused to take on the job of designing completely new spacesuits for the women.¹⁰⁷

As the pressure from the United States continued to grow, many of the original Voskhod plans had to be revamped. By November 1965, Korolev proposed canceling the manufacture of the last two Voskhod spacecraft (Voskhod 5 and Voskhod 6), because that would free up resources to focus on the Soyuz program, which was slowly becoming a more important priority. In the end, a compromise was reached: only Voskhod 6 would be canceled. The remaining missions would be launched as resources or plans allowed. At a meeting of the Military-Industrial Commission on December 16, 1965, the Soviet government added one more condition to the Voskhod program: that OKB-1 launch two Voskhods in time for the 23rd Congress of the Communist Party in March 1966 as a salute to the Party. It was a completely unrealistic deadline that threatened to derail an already haphazard project.¹⁰⁸ By the end of the year, the Soviets had accomplished only a single piloted spaceflight, Voskhod 2, the second year in a row with this dubious distinction. In the meantime, the United States finished five resoundingly successful Gemini missions in Earth orbit, capped off by the spectacular rendezvous of Gemini VI and Gemini VII in December. Frank Borman and James A. Lovell, Jr., in the latter spacecraft sealed NASA's year with a record fourteen-day mission. It was the most visible indication that the mismanagement of the Soviet space program during the 1964-65 period was finally slowing down the Soviet space juggernaut.

The Last Stand

It was in this climate of falling morale that Korolev spent the last months of 1965. It had been an extremely difficult year for the ailing chief designer. Many of OKB-1's space projects had been beset by troubles. Perhaps most embarrassing was the Ye-6 automated lunar probe project designed to achieve the first soft-landing on the surface of the Moon. Between January 1963 and December 1965, there had been eleven consecutive failures for the program, a record that had dampened the spirits of even the most optimistic of engineers." After one particularly painful failure in March 1965, Kamanin wrote in his diary: "Korolev was more distressed by the setback than anyone. He looked dejected and appeared to have aged ten years."¹⁰⁹ There were also several repeated failures for the Molniya-1 communications satellite program during 1964-65, which tested the resolve of OKB-1 engineers.

Through all this, there was also the loss of several of Korolev's closest colleagues. In January, OKB-1's Chief Designer Semyon A. Kosberg, responsible for the upper stage engines for several of Korolev's space launch vehicles, left Voronezh urgently for a meeting in Moscow. His automobile slid on the icy roads, and he was severely injured. Doctors were flown in from Moscow, but the sixty-two-year-old aeronautical engineer succumbed to his injuries. Even in death, his contributions to the space program remained hidden. He was merely identified as "a leading designer of airplane engines." The same month, Korolev attended the funeral of Andrey V. Lebedinskiy, the director of the Institute of Biomedical Problems—an institute whose

107 Kamanin 'In the Future His Name Will Probably Be ' Kamanin *Skrytiy kosmos 1964-1966* pp 220-228

108 Kamanin *Skrytiy kosmos 1964-1966* pp 275-76

109 Semenov ed *Raketno-Kosmicheskaya Korporatsiya* p 148

110 N. Kamanin 'A Coal Worth Working for ' no 44 The probe in question was Ye 6 no. 9 which failed to leave Earth orbit when the SI 5400 engine of the Blok L fourth stage failed to fire. It was named Kosmos 60 by the Soviet press to disguise its true intentions

111 'Semyon Kosberg Soviet Air Expert " *New York Times* January 5, 1965 p 33 Colovanov *Korolev* p 560 Sergey Khrushchev *Nikita Khrushchev krizisy i rakety vzglyad iznutri tom I* (Moscow Novosti 1994) p 493

creation can be directly traced back to Korolev's proposals in the late 1950s. Ivan V. Popkov, one of Korolev's favorite young engineers at OKB-1 also died in an automobile accident in January. Popkov had specialized in the design of naval ballistic missiles. Other deaths during the year included those of Georgiy M. Shubnikov, the legendary "builder" of the Baykonur Cosmodrome. And finally, there was former OKB-1 Deputy Chief Designer Voskresensky's tragic death in December.¹¹²

Korolev's own health was clearly deteriorating throughout the year. In August, he complained about not feeling well because of abnormally low blood pressure, and in September, he was afflicted with severe headaches. He also suffered from progressive hearing loss and a serious heart condition. In late 1965, he wrote to his wife: "I am in a constant state of utter exhaustion and stress, but I can under no conditions show that these things are getting to me. I am holding myself together using all the strength at my command."¹¹³ The institutional crises of the past few years, the fighting with the military, the discord with Glushko, Chelomey, and Yangel, the bureaucratic gridlock—all these were also taking a toll. By the end of 1965, he was seriously contemplating resigning from his job. His wife recalled later:

Sergey Pavlovich would sometimes come home at wit's end. He seemed much more torn up by [work-related problems] than he ever was from any domestic squabbles that we ever had. He used to come home rather quickly from work. In his last years when he would come home from some kind of meetings, he would be so emotionally torn, so exhausted, and he would say heatedly. "I can't continue to work like this, you understand. I'm not going to continue working like this. I'm leaving!"¹¹⁴

There was even talk of appointing one of his deputy chief designers as the technical director of launch operations at Tyura-Tam. As his health suffered, his temperament spiraled. He was increasingly abrupt with his associates. It did not help that Glushko continued to viciously attack Korolev throughout the year. In November, Kamanin wrote in his diary:

Sergey Pavlovich also complained about Glushko, who at a meeting of the Military-Industrial Commission had given sharp criticism of the activity of his . . . Design Bureau. The criticism, in Korolev's words, was not friendly, but sought to force him into a corner. "Glushko thinks," said Korolev, "that he is the chief successor and descendant of Tsiolkovskiy, and that we are only making tin cans. . . ."¹¹⁵

The question of keeping Korolev's identity secret had evidently been raised several times in 1965 at the level of the Central Committee. Each time, however, Party apparatchiks had delayed a final word on the issue, thus preventing his name from being associated with that of the mythical "chief designer" of the Soviet space program.

Being spread too thin over countless projects took its toll. Nine months after Belyayev and Leonov landed in the *taiga* of Siberia, a single Soviet cosmonaut had yet to enter space. In the meantime, NASA had flown five two-astronaut Gemini missions, each with spectacular success that visibly regained some of the public respect that had been lost during the age of Sputnik and Vostok. The crowning achievement of this spurt of activity was the joint Gemini rendezvous mission in December, when two spacecraft had carried out the first rendezvous in

112 Golovanov *Korolev* p 771

113 *Ibid*

114 *Ibid* p 770

115 Kamanin *In the Future His Name Will Probably Be* " p 30

orbit. It must have been a sobering realization to the cosmonauts and Korolev that *even* if the Soviets had flown their Voskhods, they still would have been unable to accomplish what the Gemini astronauts had performed in December—that is, extensive maneuvering into different orbits. No doubt alarmed by the impending stagnation of their program, a group of experienced cosmonauts, along with their overseer Kamanin, authored a special letter to Soviet leader and General Secretary of the Communist Party Brezhnev on October 22, 1965. In it, they highlighted the gridlock in the space program because of the immensely complicated management system, the undue focus on automated systems over piloted ones, and the poor funding of the space program. Cosmonaut Gagarin personally handed the letter to Brezhnev's aides, but three months later, they were still waiting for even an acknowledgment of his having received it."¹¹⁶

In this climate, Korolev was not much help. On December 26, 1965, he and his wife Nina visited the Cosmonaut Training Center at Zelenyy near Moscow, perhaps to boost the morale of the many cosmonauts who were apprehensive of the delays in the Voskhod and Soyuz programs."¹¹⁷ They were received by Center Director Maj. General Nikolay F. Kuznetsov and his Deputy Gagarin, who escorted them to the training area where cosmonaut Komarov was preparing for the primary mission of the Soyuz program, the docking of two Soyuz in orbit. Gagarin asked the chief designer about OKB-1's plans for the immediate future, perhaps trying to elicit some hint of what the cosmonauts could expect. Korolev was vague:

*Right now, we're preparing the launch of the Soyuz. . . . It has already tested well in unmanned flights. We are also working on a space station. Your comrades have already seen the wooden model. . . . We are also working on effecting an unmanned soft lunar landing and conducting research in outer space. . . . You'll learn more about the work once you become involved in it.*¹¹⁸

Kamanin wrote in his journal on January 5:

All the cosmonauts are pessimistic as never before. Their limitless faith in Korolev has been dealt a serious blow by Korolev himself: Sergey Pavlovich came to the Center, met with the cosmonauts, but could not tell them anything definite about the next flight."

Korolev's health in the meantime became more and more frail. Between December 14 and 17, he had undergone a series of medical tests in Moscow, which had indicated to doctors that he required to be hospitalized for at least a week for a minor operation to remove a bleeding polyp in the straight intestine. He spent his last day before the operation, January 4, 1966, at his office, staying late as usual, before being admitted to a division at the Kremlin hospital the following day.¹¹⁹ It seems that Korolev did not expect to stay in the hospital long, for he had already invited people to celebrate his fifty-ninth birthday at a party on January 14.¹²¹

¹¹⁶ This letter has been reproduced in full in Kamanin, *Skrytyy kosmos 1964–1966*, pp. 245–48.

¹¹⁷ A. P. Romanov and V. S. Cubarev, *Konstruktory* (Moscow: Izdatelstvo politicheskoy literatury, 1989), p. 183.

¹¹⁸ Nikolai Kuznetsov, "A Leader Among Leaders," in V. Mitroshenkov, ed., *Pioneers of Space* (Moscow: Progress Publishers, 1989), p. 93. The "unmanned" flights to which Korolev referred may have been the suborbital mission(s) of a stripped-down Soyuz descent apparatus launched on the R-5V scientific missile.

¹¹⁹ Kamanin, "In the Future His Name Will Probably Be . . ." p. 30.

¹²⁰ Ishlinskiy, ed., *Akademik S. P. Korolev*, p. 68; Golovanov, *Korolev*, pp. 773–74; Nicholas Daniloff, *The Kremlin and the Cosmos* (New York: Alfred A. Knopf, 1972), p. 119. Kamanin says that the operation was to "remove a tumor in the duodenum." See Kamanin, "In the Future His Name Will Probably Be . . ."

¹²¹ His birthday was on January 12, but Korolev preferred to celebrate it on January 14. Confusingly, his actual birth date in the Julian calendar system used by Russians prior to the Great October Revolution was December 30.

The original date for the operation was January 5, but was delayed to run some more tests. In the meantime, Mishin temporarily took over for Korolev while the latter was indisposed. Even from the hospital bed, Korolev tried to keep his hand in the design bureau's activities. During a crisis on January 7 at a meeting of the Collegium of the Ministry of General Machine Building, Minister Afanasyev had forced Deputy Chief Designer Chertok "to hear scathing criticisms . . . of the shortcomings of the Bureau and its senior officials." Mishin was indignant after the meeting and returned to his office and wrote out a letter of resignation from OKB-1. Fortuitously or not, one of his aides saw Mishin prepare the document, and immediately called Korolev. Korolev asked his deputy what he was doing. Mishin replied. "Writing my [resignation]. It is hard enough to work with you, but with [Afanasyev] there is no way." Korolev replied. "Tear up the report, ministers come and ministers go, but we stay in our business. Resignations are the only thing they want of us." "

On January 11, Dr. Boris V. Petrovskiy, the USSR Minister of Health, personally performed a histological analysis on Korolev and excised a small piece of polyp from the gastrointestinal tract, causing excessive bleeding. Given Korolev's paramount importance as a state figure in the Soviet Union, it would have been unusual for anyone else but the Minister of Health to operate on Korolev. Despite his high rank, Petrovskiy was indeed an accomplished surgeon and regularly operated on patients during this period. However, Petrovskiy may not have been completely prepared for the operation on the morning of January 14. Several key surgeons, including Petrovskiy's deputies, were inexplicably absent on that day, even though it was not a holiday. There were numerous complications with Korolev himself. He had not revealed to the doctor that his jaw had been broken in prison from torture in 1938, which made it difficult for him to open his mouth wide. His unusually short neck compounded the problem, and it prevented doctors from using an intubation tube into his lungs. Instead, they performed a tracheotomy and inserted a tube via an incision in his neck. His jaw problem necessitated the use of a general anesthetic despite the uncertainty over his heart condition. Even the anesthetic was in short supply. Korolev bled profusely during the operation. Petrovskiy later wrote in his memoirs:

A laparotomy (the process of opening the abdominal cavity) indicated the presence of an immovable malignant tumor which had grown into the rectum and the pelvic wall. Using an electronic scalpel, we were able to extract this tumor only with great difficulty and conduct a biopsy, which confirmed the presence of this malignant tumor — which was an angiosarcoma.¹²³

The size of the tumor, larger than a person's fist, was a shock to those in the operating room. As Korolev lay profusely bleeding, Petrovskiy realized that Korolev was in serious danger. With tensions rising, Dr. Aleksandr A. Vishnevskiy, a noted cancer specialist, was called in. The two evidently completed the operation, four hours after it had started, but half an hour later, Korolev's pulse abruptly stopped. Despite repeated attempts to revive him, he was gone. He had just turned fifty-nine.¹²⁴

The news was devastating to the space community. On the evening of the operation, all of Korolev's deputies and division chiefs assembled at OKB-1 in complete disbelief. None had any idea that Korolev's condition was that serious. Most doctors later believed that with or without

¹²² Tarasov "Missions in Dreams and Reality" Golovanov *Korolev* p 770 Mozzhorin *et al* eds Dorogr *U kosmos* I p 120

¹²³ Golovanov *Korolev* p 775

¹²⁴ *Ibid* pp 774-78

the operation. Korolev did not have very much longer to live—perhaps a few months. Still in shock, Korolev's principal deputy, Mishin, ordered Deputy Chief Designer Chertok to quickly prepare an official obituary and to take it personally to Ivan D. Serbin, the feared chief of the Defense Industries Department at the Central Committee. Serbin amended Chertok's original draft. By this time, Soviet leader Brezhnev personally decided to allow a link between Korolev's name and the Soviet space program. The chief designer's identity would finally be revealed to the public." Mishin later recalled that even at this juncture, there was resistance from higher placed Party officials to reveal Korolev's name. The signatures of Mishin, Chertok, and Korolev's other deputies were removed from the obituary because of security reasons."

The official Soviet news agency TASS announced his death on the morning of January 16 as the leading news item of the country. A medical report accompanying the obituary stated that he had been suffering from a malignancy in the intestine, sclerosis of the arteries, emphysema, and an upset metabolism. The cause of death was said to be "cardiac insufficiency" during the operation."? Korolev's arch enemy Glushko was apparently unperturbed by the sudden death. Clushko was conducting a meeting on January 14 when his Kremlin phone line rang. He heard the news, hung up, and turned to his audience and said, "Sergey Pavlovich is no longer with us." He paused for a second and continued. "Now where did we leave off?"¹²⁸ In the West, his importance to the Soviet missile and space program was not clearly understood at the time. *The New York Times* carried his obituary on page 82 of its Sunday edition, mentioning that Korolev was a "designer of sputniks and manned space capsules."

Korolev was given a state funeral on January 18, the likes of which had not been seen in many years in Moscow. The urn with his ashes was carried from the House of Unions by Smirnov, Afanasyev, Keldysh, Tyulin, Gagarin, and others, following which the senior cosmonauts carried it from the Historical Museum to Red Square. There, Brezhnev, Podgorny, and other Soviet leaders lifted the urn and placed it in the Kremlin Wall.¹³⁰ Smirnov then placed the urn in the niche, which was then covered with a marble plaque with the following inscription:

KOROLEV Sergey Pavlovich 30.12.1906– 14.01.1966¹³¹

Speakers at the funeral eulogized Korolev's accomplishments with dry and banal cliches. Keldysh added that "one of the greatest achievements of science and technology, the era of man's exploration of space, will always be associated with Korolev's name." Kamanin's journal entries for the day add some telling commentaries about the funeral:

Korolev occupied a place in the Kremlin Wall next to S. V. Kurashov (USSR Minister of Health). I was irritated by the fact that they were neighbors: it unnecessarily reminded me of the great guilt of our medicine in the premature death of Sergey Pavlovich. All of

125. Chertok. *Rakety i lyudi: goryachye dni kholodnoy voyny* p. 361; Semenov, ed., *Raketno-Kosmicheskaya Korporatsiya*, p. 158. Mishin recalls that the obituary was written by him, not Chertok. See Tarasov, "Missions in Dreams and Reality"

126. Tarasov. "Missions in Dreams and Reality"; Mozzhorin, et al. eds., *Dorogi v kosmos* I p. 121

127. Daniloff. *The Kremlin and the Cosmos*, p. 119

128. Golovanov. *Korolev*, p. 779

129. "Sergei P. Korolev is Dead at 59: Leading Soviet Space Scientist," *New York Times*, January 16, 1966, p. 82

130. Theodore Shabad. "Chief Soviet Space Designer Is Buried in Kremlin," *New York Times*, January 19, 1966, p. 10. He was cremated at 9 p.m. on January 17.

131. Kamanin. "In the Future His Name Will Probably Be . . ."

132. Shabad, "Chief Soviet Space Designer Is Buried in Kremlin."

the orators at the funeral gathering especially solicitously stressed the thought that Korolev was a great scientist, but not the chief director of space studies, that there we had many like Korolev. This is not true. I know that thousands of staff and dozens of Chief Designers worked along with Korolev, but it was he who was the Chief Designer of spacecraft, and not only in post, but in essence as well. I will always place unlimited value on Korolev's talent. I knew features of his character which were not the best, but they cannot hide the magnitude of the figure of our Chief Designer. His name should be before the names of all our cosmonauts. I am deeply convinced that it will be so."

Thus ended not only the life of the architect of the early Soviet successes in space, but also a momentous era in the history of space exploration. As a manager, designer, politician, lobbyist, engineer, and flight director, he had carved out a position for himself that defied any singular title. Each one of the responsibilities that he had carried on his shoulders was vacant. His successors would try to fill the vacuum, but in truth, things would never be the same again.

CHAPTER TWELVE

A NEW BEGINNING

Sergey Pavlovich Korolev's death ended one man's unprecedented twenty-year reign over Soviet missile and space programs. He bequeathed to his associates and aides the daunting task of managing an empire whose intricacies had only been clear to him. While many of his deputies were certainly adept in various areas of directing the works of OKB-1, no single person had expertise in managing the design bureau, dealing with Soviet politicians, brokering deals with other chief designers, and instilling a vision of space exploration among the thousands who worked at the firm.

Unlike no other chief designer before or since, Korolev dominated the Soviet space program. His informal title in the official Soviet press before his death was not "chief designer of OKB-1," but rather "chief designer of rocket-space systems"—a far-more melodramatic moniker than simply the head of a design bureau. His vast array of roles in the space program did not, for the most part, come from his official appointments (which were many), but rather from his larger-than-life personality. Thus, when he died, there was an unprecedented vacuum. While his successor would inherit the title of chief designer of OKB-1, he would not have Korolev's informal powers accrued through twenty years of making history. In some ways, the post-Korolev period was characterized by an equal playing ground, with the leading chief designers no longer following a single voice. This also meant that there was no single ardent supporter to push projects. The lobbying from the bottom up as a consequence became more diffuse and less imposing in contrast to the Korolev years.

Mishin

The first order of business for a demoralized Soviet space program was to choose a successor to Korolev. The normal procedure for selecting a new chief designer would have been for Minister of General Machine Building Afanasyev to discuss the names of candidates with Secretary of the Central Committee Ustinov. The proposal would be presented to the Central Committee, whose members would pass it on to the Politburo. In the case of OKB-1, Korolev's senior staff did not want to risk having an unwanted individual appointed chief designer by higher-ups, and they tried to take the matter into their own hands. The night after Korolev's death, one of his most beloved former proteges, Chief Designer Viktor P. Makeyev of SKB-385, flew into Moscow from his home base at Miass to try and bring some order into the succession. Makeyev assembled all the senior staff at OKB-1 and asked them for opinions. Some suggested that Makeyev himself take over the design bureau, but he was firmly against doing so; he had as many as sixteen submarine-launched ballistic missile projects ongoing at Miass, far too much work to be suddenly moving to another organization.¹

¹ B. Ye. Chertok, *Rakety i lyudi goryachiye dni kholodnoy uoyny* (Moscow: Mashinostroyeniye, 1997), pp. 368–69.

It took a long time to come to a decision. One who was there, Deputy Chief Designer Yevgeniy V. Shabarov, recalled many years later that:

... through the night we wrote a letter addressed to the Secretary of the [Central Committee], the Chairman of the Military-Industrial Commission, and to [our] minister. In the letter we proposed that in our opinion, Vasiliy Paulovich *Mishin* be appointed the successor to Sergey Paulovich Korolev since he had been [*Korolev's*] First Deputy. We also offered various other reasons for the choice. At five in the morning the letter was ready and we all signed it.'

Bushuyev and Chertok had originally proffered Mishin's name. Only one deputy, Sergey S. Kryukov, had opposed Mishin's candidacy. All other senior staff agreed that Mishin would be the best person for the job. The prompt action by OKB-1 senior staff seems to have surprised government officials, who were not too happy with this internal recommendation. Mishin remembered that:

my appointment ... encountered some opposition from Ustinov who at the time was a Secretary of the Central Committee ... overseeing defense matters. He wanted to use the occasion to limit the authority and jurisdiction of the Chief Designer and put him under an administrative head of *OKB-1*. Ustinov had made such attempts during *Korolev's* lifetime but they had run up against Korolev's well-argued *objections*.¹

By the time that the senior staff at OKB-1 officially proposed Mishin's name, Communist Party officials had already decided on an alternative person to head the design bureau: Georgiy A. Tyulin, then the First Deputy Minister of General Machine Building. Ustinov believed that by appointing Tyulin as "administrative head" of OKB-1, he would be able to curb some of the undeniable powers of the chief designer of such an important design bureau. The papers for Tyulin's appointment were drawn up, but there were long drawn-out negotiations on the issue, and it took an astonishing five months before the Central Committee agreed to ratify the original proposal from the OKB-1 senior staff. On May 5, 1966, Soviet leader Brezhnev summoned Mishin to the Kremlin and informed him of his promotion, and six days later, Minister of General Machine Building Afanasyev signed an order officially appointing Mishin as the new chief designer of the organization.

Mishin was clearly the most likely choice as a successor, having been groomed by the late Korolev for almost a decade for this position. But he did not have his predecessor's stature or clout. In fact, Mishin had somewhat of a reputation for being blunt and tactless and was not known for his diplomatic skills. He was, however, respected for his engineering skills. One military officer who closely worked with Mishin recalled that he was:

An excellent mathematician, a fast thinking engineer. He knew the business and, most important, could screen options as fast as a computer. ... *Mishin* possessed very specific information. He was always ready to come up with a strong rebuke at the Council of Chief Designers where he was invited. He deferred to no authority as long as the authority in question came up with solutions that defied logic and common sense to serve a hidden agenda. That is why he was not popular⁴

2. Yu. A. Mozzhorin, et al., eds., *Dorogi v kosmos I* (Moscow MAI, 1992), p. 182.

3. *Ibid.*, p. 121.

4. Mikhail Rebrov, "The Secrets of Rocket Codes" (English title), *Krasnaya zvezda*, June 3, 1995, p. 6.



Vasily Mishin succeeded Korolev as OKB 1 Chief Designer after Korolev's death in January 1966. This photo probably dates from early 1968. In the background are Major General Aleksandr Kurushin (left) commander of the Tyura Tam range at the time and Major General Anatoliy Kirillov (right) Kurushin's deputy (copyright Christian Lardier)

This is an important distinction from Korolev, who, perhaps because he better understood the workings of the political machinery of the Communist Party, was more willing to work out problematic issues than let them languish in deadlock. Mishin, stubborn to the end, refused to budge if his instincts told him so, sticking to his beliefs until the bitter end. Lacking the political instincts of say a Wernher von Braun or a Sergey Korolev, he suffered dearly. Some would argue that so did the Soviet space program in the coming years.

Mishin's appointment as chief designer was only one of several different honors bestowed upon him. He replaced Korolev's vacant position as the head of the somewhat amorphous Council of Chief Designers for programs in which his design bureau had the leading role. Thus, at least during the meetings of the council, he outranked much more senior designers such as Clushko, Pilyugin, and Isayev. In March 1966, Mishin was inducted into the Presidium of the Interdepartmental Scientific-Technical Council on Space Research, headed by Academy of Sciences President Keldysh. That council continued its critical advisory role of implementing the Soviet space program by serving as "expert commissions" for a plethora of projects.¹ Finally on July 1, 1966, Mishin was promoted to the rank of full Academician of the USSR Academy of Sciences. Along with Mishin, three other major space designers—Barmin, Pilyugin, and

5 Interview, Georgiy Stepanovich Vetrov with the author, November 15, 1996

Yangel—also became Academicians the same day, joining the select group of Glushko and Chelomey.⁶

These six designers—Barmin, Chelomey, Glushko, Mishin, Pilyugin, and Yangel—all Academicians, commanded great respect among the upper echelons of the space industry, but their ascendance was also evidence of a great diffusion of power. For example, of the six, only one (Yangel) was allowed to become a Candidate Member of the Central Committee of the Communist Party—an unprecedented honor that even Korolev did not enjoy. It was in fact Yangel's new appointment as a Candidate Member that prompted many Western analysts to come to the conclusion that Yangel had "succeeded" Korolev as the "chief" of the Soviet space program, as if the entire effort was run by a single monolithic organization. This was an error in analysis that would not be dispelled until well into the 1970s, when the concept of "design bureaus" filtered out through the curtain of censorship. What was equally unknown at the time was that Yangel's honorary promotion as a Candidate Member of the Central Committee probably stemmed not from his achievements in space, but rather from his clearly notable contributions to the development of strategic ballistic missiles. More evidence of the diffusion of power was the choice of Korolev's replacement as a member of the Presidium of the Academy of Sciences, the highest arbiters of scientific research in the Soviet Union. Neither Glushko, nor Yangel, nor Mishin, nor Chelomey filled the position in May 1967—rather, it was Chief Designer Pilyugin, responsible for guidance systems.⁷

Soon after the changeover in leadership at the design bureau, the Ministry of General Machine Building enacted a ministry-wide change in naming of institutions, which effectively replaced the "OKB-plus-number" system with an even more bewildering designation system. Almost every design bureau involved in the missile and space industry would have the dreary phrase "machine building" attached to its name, perhaps as a somewhat comical way to disguise the true roles of these organizations. Thus on March 6, 1966, OKB-1 became the new Central Design Bureau of Experimental Machine Building, or "TsKBEM" in its Russian abbreviation. Chelomey's OKB-52 meanwhile became the almost identical Central Design Bureau of Machine Building, or "TsKBM," distinguished only by the omission of an "E" in its abbreviation.⁸ At the same time, Mishin enacted a large-scale restructuring of his design bureau in

6 Chertok *Rakety i lyudi goryachiye dni kholodnoy uoyny* pp 516–17 Christian Lardner 'Soviet Space Designers When They Were Secrets' presented at the 47th International Astronautical Federation IAA 96 IAA 2 2 09 Beijing China October 7–11 1996 V P Glushko had become an Academician on June 20 1958 while V N Chelomey had become one on June 29 1962 Note that there were also a number of *scientists* who were Academicians who were involved in the ballistic missile and/or space programs These included A A Blagonravov (became an Academician in September 1943) A Yu Ishlinskiy (in June 1960) M V Keldysh (in November 1946) S A Khristianovich (in September 1943) V A Kotelnikov (in October 1953) B N Petrov (in June 1960) C I Petrov (in June 1958) and L I Sedov (in October 1953) In addition there were several other designers and/or scientists in the space program who were Corresponding Members of the Academy of Sciences—that is junior to full Academicians These included A F Bogomolov (in July 1966) K D Bushuyev (in June 1960) V I Kuznetsov (in June 1958) N S Lidorenko (in July 1966) A M Lyulka (in June 1960) D Ye Okhotsimskiy (in June 1960) B V Raushenbakh (in July 1966) M S Ryazanskry (in June 1958) S S Lavrov (in July 1966) and S K Tumanskiy (in June 1964)

7 Lt Gen G Tyulin 'Look Forward' (English title) *Krasnaya zvezda* May 18 1988 p 4

8 Yu P Semenov ed *Raketno Kosmicheskaya Korporatsiya "Energiya" imeni S P Koroleva* (Korolev RKK Energiya named after S P Korolev 1996) p 158 Mikhail Rudenko 'Designer Chelomey's Rocket Planes' (English title) *Vozdushniy transport* 52 (1995) 8–9 Chertok *Rakety i lyudi goryachiye dni kholodnoy uoyny* p 403 Some of the other organizations whose names were changed included Glushko's OKB 456 which in January 1966 was renamed the Design Bureau of Power Machine Building (KB EnergoMash) Mozhgorin's NII 88 which in January 1967 was renamed the Central Scientific Research Institute of Machine Building (TsNIIMash) Barmin's GSKB SpetsMash which in January 1967 was renamed the Design Bureau of General Machine Building (KB OM) and Yangel's OKB 586 which in October 1966 was renamed the Yuzhnoye Design Bureau (KB Yuzhnoye)

November 1966, creating ten subdivisions, each designated a "complex," dedicated to a specific mission profile. His two First Deputy Chief Designers were Sergey O. Okhapkin and Dmitriy I. Kozlov, both of whom had worked under Korolev since 1946."

Okhapkin, a prematurely gray-haired man full of verve and energy, had served his apprenticeship under such famous Soviet aviation Myasishchev designers as Tupolev, and Ilyushin before joining Korolev's team in 1948 as an expert on dynamics and precision. In December 1952, he became a deputy chief designer, eventually directing planning work on the NI booster. Upon Mishin's appointment, Okhapkin headed OKB-1's Complex 1, dedicated to rocket systems, which included the NI.⁹ Kozlov, on the other hand, had headed the old Branch No. 3 at Kuybyshev since its establishment in 1960. After Korolev's death, the branch remained subordinate to the main center at Kaliningrad, although Kozlov's primary work was related not to piloted systems but rather the development of high-security military reconnaissance satellites. Apart from Okhapkin and Kozlov, there were five remaining deputy chief designers for spacecraft, guidance systems, rocket engines, ground equipment, and testing.¹⁰

As with all notable figures in the space program, the identities of Mishin, Okhapkin, and Kozlov were kept state secrets, and the Soviet press completely refrained from commenting on the nature of the succession to Korolev. Eventually, by the late 1960s and early 1970s, they were allowed to use pseudonyms when writing articles in the popular media.¹¹ Unlike Korolev, Soviet journalists did not refer to Mishin as the "chief designer of rocket-space systems," but rather the less encompassing "chief designer of piloted spaceships." It was a small, but telling indication that Korolev's old design bureau had reached its zenith of power and that glory days were no longer ahead but consigned to the history pages.



OKB-1 Deputy Chief Designer Sergey Okhapkin was one of the principal forces behind the creation of the NI rocket. After Mishin's appointment as OKB-1 Chief Designer, Okhapkin served as First Deputy of the organization, primarily responsible for the quickly accelerating work on the NI (files of Peter Gorin)

⁹ For Okhapkin, see Semenov, ed., *Raketno-Kosmicheskaya Korporatsiya*, p. 158. For Kozlov, see V. Drebkova, "Anniversaries: General Designer D. I. Kozlov—75 Years" (English title), *Novosti kosmonavtiki* 20 (September 24–October 7, 1994): 56. Note that Kozlov assumed his post in 1967, not 1966.

¹⁰ Yaroslav Colovanov, *Korolev. fakty i mify* (Moscow: Nauka, 1994), pp. 478–80.

¹¹ They were K. D. Bushuyev (spacecraft, Complex 2), B. Ye. Chertok (guidance systems, Complex 3), M. V. Melnikov (rocket engines, Complex 5), A. P. Abramov (ground equipment, Complex 6), and Ya. I. Tregub (testing, Complex 7). Complex 4 was for the Experimental Machine Building Plant (ZEM) attached to the design bureau. It was headed by TsKBEM First Deputy Chief (but not Deputy Chief Designer) V. M. Klyucharev. See Semenov, ed., *Raketno-Kosmicheskaya Korporatsiya*, pp. 158–59. Note that Klyucharev was appointed to his position on September 8, 1967.

¹² Their pseudonyms were M. P. Vasilyev (Mishin), S. O. Osipov (Okhapkin) and D. Ilichev (Kozlov). See Lardiei, "Soviet Space Designers When They Were Secrets."

The End of Voskhod

Mishin's first job as Chief Designer of TsKBEM was to assess the state of the Voskhod program. At the time of Korolev's death, there were immediate plans for three to four Voskhod and five Soyuz missions in 1966. The first one, Voskhod 3, was the long-duration mission with cosmonauts Volynov and Shonin, planned for almost a year. The spectacular success of the fourteen-day Gemini VII flight in December 1965 had given the Soviet mission even more of an impetus to get off the ground. There seems to have been some effort from ministerial leaders to substitute the all-woman EVA flight in place of Voskhod 3, but this attempt did not bear fruit." The subsequent Voskhod 4 would be a scientific flight, including artificial gravity experiments with test pilot Beregovoy and scientist Katys, while Voskhod 5 would be a military mission with cosmonauts Shatalov and Demin. An extra mission, with only dogs, would precede Voskhod 3 to test the extended life support systems on the near-obsolete 3KV spacecraft.

The Voskhod 3 mission was timed to coincide with the opening of the 23rd Congress of the Communist Party in early March 1966, as a "gift" to the doctrinal keepers of the Soviet Union. This flight, and the additional two or three Voskhod missions, would also serve to bridge the gap to the inaugural jaunt of the Soyuz spaceship, then slated for sometime in late 1966. From a public relations perspective, the remaining Voskhod expeditions would no doubt deflect worldwide attention from NASA's successful Gemini program. Certainly, the Voskhod 3 mission, dedicated to regaining the mission duration record claimed by Gemini VII, would be an outstanding publicity victory for the Soviet space program.

On January 27, about two weeks after Korolev's death, Mishin hosted the first technical meeting at OKB-1 under his management to discuss the future Voskhod missions. The attendees decided to prepare Voskhod spacecraft 3KV no. 5 for launch with two dogs in the first half of February. Some from the military, particularly Air Force Lt. General Kamanin, opposed such a thirty-day biomedical precursor mission, apparently because he believed that it would unnecessarily delay the Voskhod 3 mission, which was very important to future military operations in space. Cosmonauts had extensively trained to use an infrared optical instrument named *Svinets* ("Lead"), which would allow them to observe plumes from the launches of four Soviet ballistic missiles. At the same time, officials decided to launch spacecraft 3KV no. 6 (Voskhod 3) on an eighteen-day mission during March 10–20, 1966—that is, after the landing of the precursor mission. The primary limiting factor for the extended mission seems to have been the poor performance of the Voskhod spacecraft's life support system, in particular its air regeneration capabilities, which most believed would not guarantee safety for two cosmonauts for a period of eighteen days in space.¹⁴ A second similar meeting on February 10 confirmed the general state of readiness to carry out the two flights.¹⁵

¹³ See for example N. P. Kamanin *Skrytiy kosmos kniga vtoraya 1964–1966gg* (Moscow: Infortekst IF 1997) pp. 284, 286, 288.

¹⁴ *Ibid.* pp. 293–94. Among those present for this meeting were V. P. Mishin (OKB 1), G. A. Tyulin (MOM), P. V. Tsybin (OKB 1), K. D. Bushuyev (OKB 1), A. I. Burnazyan (Ministry of Health), A. G. Karas (TsUKOS), K. A. Kerimov (MOM), G. I. Voronin (OKB 124), S. C. Darevskiy (SOKB LII), N. P. Kamanin (VVS), N. F. Kuznetsov (TsPK), Yu. A. Gagarin (TsPK), V. M. Komarov (TsPK), Ye. A. Karpov (GKNII AikM), A. M. Genin (GKNII AikM), A. N. Babiychuk (WS), S. G. Frolov (WS), and V. A. Smirnov (WS).

¹⁵ *Ibid.* pp. 300–01. The meeting was also the forum to formally approve the membership of the first post-Korolev State Commission. This State Commission for Voskhod would now include G. A. Tyulin (Chairman from MOM), M. V. Keldysh (AN SSSR), S. I. Rudenko (VVS), V. P. Mishin (OKB 1), N. N. Smirnitkiy (CURVO), V. A. Kasatanov (affiliation unknown), V. A. Kazakov (MAP), A. C. Karas (TsUKOS), G. P. Melnikov (NII 4), N. P. Kamanin (VVS), A. A. Kurushin (NIIP 5), P. V. Tsybin (OKB 1), I. D. Spitsa (TsKIK), Ye. V. Shabarov (OKB 1), V. N. Pravetskiy (Ministry of Health), and I. T. Butychev (MO).

There were no major delays in the preparation of the precursor mission, and Tyulin gave the final approval for the launch at a State Commission meeting on February 17. Two dogs, selected for the flight after a rigorous selection process at the Institute for Biomedical Problems in Moscow, would fly a twenty-five-day mission. The 3KV-type Voskhod vehicle, spacecraft no. 5, was launched at 2310 hours Moscow Time on February 22, 1966, and named *Kosmos-110* upon entering orbit. The craft carried dogs named Veterok and Ugolek into a highly elliptical initial orbit of 187 by 904 kilometers at a 51.9-degree inclination. The high apogee of the orbit was evidently an attempt by Soviet scientists to examine the effects of the Van Allen radiation belts on the dogs. It was an element of the flight that had originally emerged as early as 1963 during planning for the Vostok program. The State Commission hoped to launch the subsequent Voskhod 3 craft into a similar orbit not only to study radiation effects, but also to claim the absolute altitude record for a piloted space vehicle. With the launch of Kosmos-110, for the first time in the Soviet space program, a piloted spacecraft used the fifty-one-degree inclination for the orbit—a practice that would be adopted for almost all the remaining crewed space missions in the Soviet era. This inclination not only allowed the IIA57 launch vehicle to lift the heaviest payload into orbit without having to land in China in case of an abort, but it also would provide optimal flight conditions for future missions to the Moon. The total mass of the vehicle was 5,600 kilograms, with 3,000 kilograms of that mass for the spherical descent apparatus that contained the two dogs.¹⁶

While the primary goal of the flight was to test the life support system in preparation for Voskhod 3, Kosmos-110 also had a number of supplementary scientific goals. Apart from the dogs themselves, there were various types of yeast preparations, samples of blood serums, protein growths, chlorella, and lysogenic bacteria aboard the spacecraft. "Throughout the mission, the two dogs were fed anti-radiation drugs and food delivered by means of tubes into their stomachs. Veterok served as the experimental specimen, while Ugolek was the control animal. By March 4, things seemed to be proceeding normally. The only minor problem was a deployment malfunction in one of the communications antennas. On March 14, about twenty days into the flight, the State Commission met to discuss the progress of Kosmos-110. Although the condition of the dogs and cabin atmosphere parameters, such as pressure, temperature, humidity, and carbon dioxide content, were within normal range, there had been "a steady tendency of gradual deterioration of the composition of air in the cabin."¹⁷ Some recommended immediately terminating the flight and recovering the dogs, while others, notably life support system Chief Designer Voronin, expressed confidence in a full twenty-five-day flight. A special landing commission consisting of twenty-five officials discussed the issue in detail throughout the night. By the next morning, all agreed that the flight should be curtailed and the dogs brought down. At 1400 hours Moscow Time on March 16, ground controllers began operations necessary for reentry. Three hours and fifteen minutes later the dogs landed safely 210 kilometers southeast of Saratov, approximately sixty kilometers from the intended landing spot. About thirty to forty minutes later, rescue teams were able to report that the dogs were in safe hands. The flight had lasted nearly twenty-two days.

The physicians who examined the dogs upon their return did not anticipate the poor conditions of the animals. In an official report published two months after the landing, the doctors reported that the animals suffered from muscular reduction, dehydration, calcium loss, and confusion in readjusting to walking. Their motor systems did not return to normal until eight to ten days after the end of the mission, while full restoration of blood circulation system did

16. C. A. Kustova, *Ot pervogo Sputnika do "Energii" - "Burana" i "Mira"* (Kaliningrad: RKK Energiya, 1994), p. 57.

17. V. P. Glushko, ed., *Kosmonavtika entsiklopediya* (Moscow: Sovetskaya entsiklopediya, 1985), p. 203.

18. Kamanin, *Skryty kosmos 1964-1966*, p. 314.

not occur until five days after landing. The doctors added dramatically. "Prolonged space flight and the development of methods to combat unfavorable effects of such flights have raised new problems for space medicine."¹⁹

The Kosmos-110 mission was to have cleared the way for the piloted Voskhod 3 mission. but during the flight itself, events on the ground had necessitated a second look at safety issues in connection with the 3KV Voskhod spacecraft. As early as February 2, Chief Designer Fedor D. Tkachev of the Scientific-Research and Experimental Institute of the Parachute Landing Service reported that during the past three simulated landing tests of the heavy Voskhod spacecraft, the parachutes had ruptured. A fourth consecutive failure soon after did not prevent the launch of Kosmos-110 but raised serious questions about the system as a whole. Continuing problems with the life support system prompted both OKB-124 and the Ministry of Health's Institute for Biomedical Problems to initiate long-duration ground simulations to assess the feasibility of carrying out a twenty-day mission in the Voskhod spacecraft. A third technical problem was the bothersome failure of the Blok I third stage of the 11A57 launch vehicle during a ground test in December 1965, apparently because of high-frequency oscillations in the stage. Although the stage had not failed in flight, engineers at OKB-154 in Voronezh had still not identified the reasons for the explosion.²⁰

Throughout the Kosmos-110 mission, there were rumors from Moscow that a piloted mission was imminent. On March 9, the United Press International reported that the Soviet Union would launch a multcrewed spacecraft before the end of March 1966, in time for the 23rd Congress of the Communist Party.²¹ The rumors were relatively precise and reported that the craft would fly through the Van Allen radiation belts. There was less confidence behind the scenes. The long-duration ground test runs of the life support system did not produce encouraging results. After fourteen days, the Institute for Biomedical Problems had to terminate its exercise because of a worsening of the atmosphere in the cabin. OKB-124's similar experiment was shut down after sixteen days. Parachute failures meanwhile continued to accumulate throughout March. About the only positive news was on February 28, when the Air Force declared the four cosmonauts training for the flight—Beregovoy, Shatalov, Shonin, and Volynov—ready for launch.²² Coincidentally, Dr. Norair M. Sisakyan, the Academic Secretary of the Department of Biological Sciences of the Academy of Sciences, died in mid-March amid the intense discussions prior to Voskhod 3.²³ He had played a key role in biomedical aspects of all Soviet piloted space missions beginning with the early suborbital flights of dogs in the early 1950s, and his death must have been a severe blow to Soviet space medicine. By the time of his death, well before the landing of Kosmos-110, the Voskhod 3 mission was quietly moved back to late April at the earliest.

On March 22, Mishin's engineers held a meeting to discuss the problems and assess the results of the Kosmos-110 mission. The only anomalies during the flight had been the failure of the Zarya antenna, a malfunction in the ion sensor, and a problem with the Signal high-frequency transmitter. Biomedicine specialists were already in the midst of two renewed long-duration ground tests of the life support system. If the results from the tests were satisfactory,

19 Raymond H. Anderson 'Soviet Dogs Lost Muscular Control in Space' New York Times May 17 1966
Raymond H. Anderson 'Gagarin Hints the Soviet Is Near Orbiting Manned Space Station' New York Times April 9 1967 p 31

20 Kamanin Skrytiy kosmos 1964-1966 pp 296 300 302 305

21 'Soviet Is Said to Be Preparing Manned Test of Van Allen Belts' New York Times March 10 1966 p 15

22 Kamanin Skrytiy kosmos 1964-1966 pp 309-11

23 Dr. Norair Sisakyan 'A Soviet Biochemist' New York Times March 13 1966 p 86

Voskhod 3 would be launched around April 20–22, 1966. The engineers' perhaps overtly optimistic hopes on carrying out the mission on time were thrown into disarray within days. On March 27, 1966, a Molniya-I communications satellite lifted off from Tyura-Tam on its 8K78 booster. Unfortunately, the Blok I third stage exploded during the active portion of the trajectory, destroying the payload and the launch vehicle.²⁴ Because an almost identical variant of Blok I was set for use on the IIA57 booster for Voskhod 3, the failure raised alarms across the board. Several leading State Commission members rightly opposed an early Voskhod launch until investigators had conclusively ascertained the cause of the failure.

All through April, engineers focused on the problem with the Blok I stage, delaying the launch of Voskhod 3 week by week. The tests with the life support system had also proved to be unsatisfactory. Tentatively, officials were hoping for a piloted launch around May 20–27, 1966, but already there was a growing lobby against the flight of Voskhod 3 and in fact the Voskhod program as a whole. The conflict bubbled up to the surface on May 10, 1966, during a meeting of the Military-Industrial Commission. Mishin, Tyulin, Kamanin, and Deputy Minister of Health Burnazyan reported that all resources were ready to support the launch of Voskhod 3 on May 25–28. Military-Industrial Chairman Smirnov, however, stunned everyone by proposing to completely cancel the Voskhod 3 mission, invoking the following reasons:

- An eighteen-day flight would not provide anything new.
- The accomplishment of the Voskhod 3 mission would delay the Soyuz program, which should be the primary focal point for all activities in 1966.
- "[A] flight without maneuvers in orbit and without docking would display [the Soviets'] lag behind the U.S.A. and would be perceived by the public as proof of the superiority of the Americans."²⁵

Smirnov clearly had some cogent arguments. NASA was flying Gemini missions at the time that were much more demonstrative of American superiority in piloted spaceflight than anything Voskhod 3 could do. The chairman had the support of a number of other key industrialists, but a whole row of powerful chief designers, academicians, ministers, and military officials strongly resisted Smirnov's suggestion. Smirnov agreed to back down and asked the Voskhod State Commission to look into the matter of terminating the program as a whole.

On May 12, the day after Mishin's formal appointment as chief designer of the old Korolev design bureau, the State Commission heard status reports on the various problematic bottlenecks in the Voskhod 3 plans. A designer from OKB-154 assured commission members that the high-frequency oscillations that had caused the Molniya-I accident would not occur again, but most members remained unconvinced. Despite Chief Designer Voronin's report that the life support system was finally ready, Smirnov's abrupt speech about canceling the project had evidently made a big impression. The numerous technical glitches, combined with Smirnov's well-argued position on the pointlessness of the mission, ground the preparations for the mission into permanent inertia. As engineers argued back and forth throughout May on the reliability of the Blok I stage, State Commission Chairman Tyulin delayed the launch first to June and then to mid-July 1966.²⁶ The frustrated cosmonauts were sent off on a short holiday: it became increasingly clear that there might never be a Voskhod 3 mission. Despite the occasional

²⁴ Posting to FPSPACE list-server on the Internet by Igor Lissov, December 11, 1996; S. Valyayev, "Russia Cancelled Launch of 'Molniya-M'" (English title). *Novosti kosmonautiki* 1 (January 1–12, 1997): 29–34. The Molniya-I satellite in question was 11F67 no 5

²⁵ Kamanin, *Skrytiy kosmos: 1964–1966*, p. 337

²⁶ *Ibid.*, pp. 338–39, 343

murmurs of resuming preparations for the launch as late as November 1966, the Voskhod program was irrevocably over by June."

Smirnov was clearly the instigator in the decision, but it seems that Mishin had played a major role in its termination. Having just assumed the role of chief designer of the most prestigious organization in the Soviet space program, he was no doubt reluctant to start off his tenure with an obsolete spacecraft that would guarantee only marginal safety to its crew. As one Russian journalist later wrote, Mishin "managed to convince the leaders that the 'old junk' couldn't take the country far and would only increase the lag between the United States and Russia."²⁸ In much the same vein, another source suggests that Mishin was concerned about the obsolete design of the Voskhod spacecraft and persuaded the leaders of the Soviet space program to permit him to terminate the fruitless effort in favor of moving ahead with the much more versatile and advanced Soyuz spacecraft.²⁹

In retrospect, Smirnov and Mishin's decision to terminate the Voskhod project was a pragmatic one. Originally planned as a modest extension of the capabilities of the Vostok spacecraft in 1962 and 1963, engineers at OKB-1 continued to formulate plans for the vehicle well into 1966. The spacecraft had extremely poor characteristics and capabilities, and it was only by "cutting corners" that the engineers had managed to establish a manifest that included EVA, long-duration, and high-altitude missions. Voskhod had no capability to change orbits and, therefore, to conduct rendezvous and docking operations, placing it clearly in the first generation of space vehicles rather than the second. To spend the remaining months of 1966 preparing an obsolete spacecraft for flight would have undoubtedly delayed even further any attempts to bring the much more capable Soyuz to quick operational status. It is, however, tempting to consider the effects on public opinion and the U.S. space program if any or all of the projected Voskhod missions had been conducted on time. Many of the same objectives fulfilled in NASA's Gemini program were also planned for Voskhod. Voskhod's EVA mission was flown as Gemini IV (in June 1965), and the two-week-long mission was flown as Gemini VII (in December 1965). Then, the astronaut maneuvering unit was flown on Gemini IX (in June 1966, although the test of the unit never took place because of astronaut Eugene Cernan's troubled spacewalk), and the artificial gravity experiment and high-apogee flight was conducted on Gemini XI (in September 1966).

Some of the remnants of the Voskhod program were incorporated into Soyuz, while some were postponed indefinitely. The eighteen-day long-duration mission fell into the former group, becoming part of planning at an early stage.³⁰ The female EVA mission lost much of its support when Voskhod was canceled. The four unflown women once again found themselves without a program for which to train, and they were ordered back into their theoretical studies in pursuit of graduate degrees. The extensive medical experiments program, which included surgery on a mammal in orbit, was dropped from any further consideration: science in the Soviet piloted space program continued to be played second fiddle to military or political exigencies. The physicians selected for the Voskhod program never formally entered the cosmonaut team and returned to their jobs with little hope of ever flying into space. The autonomous EVA maneu-

27 On July 23, 1966, Kamanin ordered the Voskhod 3 crews to immediately resume training for the mission so as to be ready by September 15. Then on October 12, Kamanin wrote that Mishin ordered the resumption of preparations for the mission. Finally on November 25, Kamanin proposed carrying out Voskhod 3 in January 1967. None of these plans were evidently very serious. See *ibid.* pp. 354, 360, 382, 409.

28 Leonard Nikishin, "Soviet Space Disaster on the Revolution's Anniversary: How and Why Soviet Cosmonaut Komarov Died," *Moscow News* 9 (March 1-8, 1992): 16.

29 S. Shamsutdinov and I. Marinin, "Flights Which Never Happened" (English title), *Aviatsiya i kosmonavtika* no. 1 (January 1993): 44-45.

30 This is hinted at in V. P. Mishin, "Why Didn't We Fly to the Moon?" (English title), *Znaniye i tekhnika seriya kosmonavtika astronomiya* no. 12 (December 1990): 3-43.

CHALLENGE TO APOLLO

vering unit named the UPMK, set for use on a later Voskhod mission, was the subject of many delays. Engineers at KB Zvezda did not complete the design of the unit until 1968, two years after Voskhod was canceled. By that time, anticipating little use in the near future, the built units were put in storage for a future time. Soviet cosmonauts would not use a similar contraption until 1990, during a mission to the Mir space station. That unit, also developed by Zvezda, was designed on the basis of experience creating the UPMK. There had also been much talk of military missions in the Voskhod program. These lost all justification once the Soyuz came along, particularly the military 7K-VI variant. Finally, the artificial gravity system was found to be too complex. Even before Voskhod's cancellation, in February 1966, Mishin had proposed to Minister Afanasyev to postpone the use of the IT system to a Soyuz mission. Although crews did indeed train with the system, other priorities in the Soyuz program meant that the system was never flown in space.

The Lunar Flotilla

Korolev had adopted the lunar-orbit rendezvous profile for the mission of landing Soviet cosmonauts on the Moon. Through the mid-1960s, engineers continued to fine-tune the plan, motivated by considerations of safety. By 1967, in fact, the single-launch NI-L3 mission plan had grown into a dauntingly complicated flight plan, involving several launch vehicles and spacecraft. Mishin's engineers were most concerned over the conditions at landing. What if the LK lander was damaged upon landing on the surface of the Moon? Could the lone cosmonaut have any way of knowing this before exiting the craft to set foot on the surface? To preclude a premature disembarkation, the engineers decided to launch a separate small lunar rover to inspect the exterior of the lander. Then another question arose: what if the LK was indeed damaged and could not take off? In such a case, TsKBEM engineers proposed having a backup lander launched separately, which would land near the primary one. There were more questions: what if the primary and backup landers were too far from each other for the cosmonaut to walk from one to the other? The pilot would have to travel from site to site via the lunar rover. These complex operations on the surface of the Moon also significantly raised the requirements for precision landing. The engineers introduced two additional lunar orbiters to map the potential landing sites prior to the piloted mission. Finally, there would be supplemental lunar orbital communications satellites to act as relays during landing and surface operations. All of this was motivated because of the tight mass constraints that precluded redundancy of many of the crucial systems on the LK.

The adoption of the more complex plan meant that the piloted lunar program was inextricably linked with the vigorous robotic lunar probe program. The latter had begun in early 1958, when Korolev had proposed a series of probes—the Ye-1, Ye-2, Ye-3, and Ye-4—for initial exploration of the Moon. Of the nine launches of the first generation of probes, only three achieved any modicum of success, but these were some of the most significant firsts in the early years of the "space race." The first was the first probe to achieve escape velocity and enter solar orbit (the Cosmic Rocket in January 1959). The second was the first probe to impact on another celestial body (the Second Cosmic Rocket in September 1959). The third was the first probe to take photographs of the far side of the Moon (the Automatic Interplanetary Station in October 1959).³¹ Retroactively called *Luna 1*, *Luna 2*, and *Luna 3*, respectively, these modest spacecraft inaugurated a glorious era of robotic space exploration. By 1959, Korolev was already planning for a more

³¹ For a Western summary of the early Object Ye lunar missions see Asif A. Siddiqi, "First to the Moon," *Journal of the British Interplanetary Society* 51 (1998): 231–38.

ambitious series of spacecraft: the Ye-6 lunar soft-lander and the Ye-7 lunar orbiter. In January 1960, the Soviet government approved preliminary work on these two classes of probes."

The Ye-6 lunar lander fared extremely poorly in the ensuing years, hampered partly by the lack of redundant systems on any of the probes because of mass constraints. There were eleven launches of Ye-6 probes between January 1963 and December 1965. Of these, four were orbital launch failures, two failed to leave Earth orbit because of failures in the Blok L acceleration stage, two missed the Moon, and three crashed onto the surface of the Moon." It was a dismal record of missions that no doubt demoralized thousands of engineers. By this time, Korolev had transferred all automated lunar and interplanetary programs to the design bureau of the S. A. Lavochkin State Union Machine Building Plant, led by Chief Designer Georgiy N. Babakin. The first lunar soft-lander type flown under Babakin's command was the Ye-6M, identical to the Ye-6 except for the use of modified shock absorbers and an independent guidance system."

It was seventeen days after Korolev's death, on January 31, 1966, that the first Ye-6M probe, vehicle no. 202, lifted off from Tyura-Tam and headed for the Moon. Once it was dispatched toward the Moon, it was named *Luna 9* by the Soviet press. By all standards, *Luna 9* and its predecessors designed by Korolev's engineers were ingeniously constructed probes. On its way to the Moon, the probe was about 2.7 meters high and consisted of three sections. At the rear was the S5.5A engine powered by an amine-based fuel and nitric acid with a thrust of 4.64 tons. The main purpose of this engine was to reduce velocity upon the approach to the Moon to facilitate a soft-landing. In addition, there were four arm-mounted thrusters that would be used for the vehicle's stabilization during landing. The central cylindrical section controlled the whole craft and carried telecommunications and command units. Strapped to the central section were two jettisonable units that had a total mass of 312 kilograms. The first of these carried a radar altimeter, which would trigger the final retroburn based on the altitude from the surface of the Moon. This unit also carried attitude control thrusters for mid-course corrections on the way to the Moon. The second unit carried Sun and Moon sensors for attitude reference. The top section of the vehicle was the landing capsule of the probe."

At an altitude of 8.300 kilometers from the surface of the Moon on February 2, the attitude control jets "froze" any rolling motion in the craft and aligned it to a vertical trajectory. The radar then triggered the terminal descent sequence, and the two compartments on the side were ejected. The S5.5A engine then ignited, and five meters from the surface, a deployed sensor made contact with the ground and ordered engine shutdown. At this point, the landing capsule was thrown away from the main bus and bounced separately on the lunar surface not far from the main craft. The exact time of impact was 2145 hours, 4.25 seconds Moscow Time on February 3. Exactly 258 seconds after landing, an automatic timer activated radio transmissions from the fifty-eight-centimeter-diameter spheroid capsule. The Soviets had finally accomplished the first soft-landing of a probe on another heavenly body, nineteen days after the death of Chief Designer Korolev.

32 The earliest published mention of these two variants is in a letter dated March 26, 1960, to Military Industrial Commission Chairman D. F. Ustinov, published as S. P. Korolev, "On Expediting Operations Concerning Automated Lunar Stations (1960)" (English title) in M. V. Keldysh, ed., *Tuorcheskoye naslediyе Akademika Sergeya Pavlovicha Koroleva: izbrannyye trudy i dokumenty* (Moscow: Nauka, 1980), pp. 414-15. See also Semenov, ed., *Raketno-Kosmicheskaya Korporatsiya*, p. 146.

33 Semenov, ed., *Raketno-Kosmicheskaya Korporatsiya*, p. 148.

34 K. Lantratov, "Anniversaries: 25 Years for Lunokhod 1" (English title), *Novosti kosmonavtiki* 23 (November 5-18, 1995): 79-83. Lunar and interplanetary programs were transferred to Babakin in April-May 1965. The Ye-6M program was approved by a decree (no. 055-263) of the Central Committee of the Communist Party and the USSR Council of Ministers on August 3, 1964. What seems to be a technical prospectus for the Ye-6M has been published with disguised designations as S. P. Korolev, et al., "Automatic Stations for the First Landing on the Moon (1964)" (in Russian) in M. V. Keldysh, ed., *Tuorcheskoye naslediyе Akademika*, pp. 515-19.

35 Andrew Wilson, *Solar System Log* (London: Jane's Publishing Co., 1987), p. 33.

The 105-kilogram probe's internal equipment was protected by shock absorbers and was installed in a pressurized compartment loaded toward the bottom. Four spring-loaded petals opened on top of the lander, and the TV system was activated, returning the first panoramic pictures of the lunar surface. Ironically, the first pictures published from Luna 9 were in the British press, from transmissions intercepted by the famous Jodrell Bank radio telescope. The Soviet bureaucracy's customary inefficiencies prevented Pravda from getting the scoop. About nine full or partial scans of the surface were received by the Soviets over the following four days, by which time the batteries were exhausted. The only other experiment on board was a radiation detector measuring the Interaction of cosmic rays with the lunar soil.³⁶ Luna 9 was the first of two such spacecraft to land on the Moon. An almost identical vehicle, Luna 13, successfully landed on the Moon in December 1966.

By the time that Luna 9 landed on the Moon, Korolev's design bureau had already spent more than five years developing another robotic lunar probe that figured significantly in the Soviet piloted space program. In early 1960, Mikhail K. Tikhonravov's department at OKB-I began exploring the possibility of designing and creating a mobile research station to travel the surface of the Moon. Unlike the earlier Ye6 lunar probes, which were launched by the four-stage 8K78 booster, the new heavier probes would be launched by a variant of the N1 booster.³⁷ These studies may have had a link to even earlier research from the mid-1950s, which was publicized widely in the Soviet press. In November 1955, Yu. S. Khlebtsevich authored a detailed article in a popular journal on the technical aspects of a mobile "tankette laboratory" for traveling on the surface of the Moon. Bearing a remarkable likeness to early conceptions of such vehicles at OKB-I, Khlebtsevich's design was yet another 1950s-vintage forerunner of Soviet space achievements of the 1960s.³⁸

After a slow start exploring various options, such as wheels, tank tracks, and so on, in 1963, Korolev transferred the development of the mobile probe's chassis to the Leningrad-based All-Union Scientific-Research Institute No. 100 (VNII-100) led by Chief Designer Aleksandr L. Kemurdzhian. VNII-100's primary expertise was building tanks for the Soviet Army, but Kemurdzhian had developed a personal interest in remote-controlled space probes.³⁹ Based on research in 1963 and 1964, Korolev and Kemurdzhian emerged in July 1964 with a conception for a 900-kilogram rover as part of the L2 theme that could support piloted lunar operations. The rover's link with the piloted space program was fortified by the famous August 1964 Soviet Union decree commitment to a human lunar landing program. The rover's primary goal would be detailed topography and research for proposed landing sites for crews on the Moon. By early 1965, engineers at OKB-I had finished a draft plan for the L2 rover, but at this point, Korolev decided to transfer all robotic exploration probes to the Lavochkin design bureau.⁴⁰

36. *Ibid.*, pp. 33-35.

37. The specific variant was evidently the N11, with a launch mass of 700 tons and a lifting capacity of twenty tons. See Lantratov, "Anniversaries: 25 Years for Lunokhod-1."

38. Yu. S. Khlebtsevich, "The Road into Space" (English title). *Nauka i zhizn* no. 11 (November 1955): 33-37. An English translation of this article is included in F. J. Krieger, *Behind the Sputniks: A Survey of Soviet Space Science* (Washington, DC: Public Affairs Press, 1958), pp. 178-88. Note that Khlebtsevich had first spoken of his "tankette laboratory" in an article in *Tekhnika molodezhi* in July 1954. The earliest known description of a mobile probe on the Moon in an official Soviet document within the space program is in a letter from USSR Academy of Sciences President M. V. Keldysh to the Soviet government, dated December 22, 1962. This document has been published in an edited version as M. V. Keldysh, "On a Plan for Scientific Research into Outer Space in 1963-1963" (English title), in V. S. Avduyevskiy and T. M. Eneyev, eds., *M. V. Keldysh izbrannyye trudy raketnaya tekhnika i kosmonavtika* (Moscow: Nauka, 1988), pp. 460-62.

39. N. G. Babakin, A. N. Banketov, and V. N. Smorkalov, *Ch. N. Babakin: zhizn i deyatelnost* (Moscow: Adamant, 1996), p. 56; Lantratov, "Anniversaries: 25 Years for Lunokhod-1."

40. Lantratov, "Anniversaries: 25 Years for Lunokhod-1." There is an account of a visit in 1965 by Korolev and other engineers from OKB-I to the premises of VNII-100 in Leningrad to view the test of an early version of the lunar rover on a simulated lunar surface. See Yu. A. Mozhgorin, et al., eds., *Nachalo kosmicheskoy ery: vospominaniya veteranov raketno-kosmicheskoy tekhniki i kosmonavtiki: vypusk utoroj* (Moscow: RNITsKD, 1994), pp. 48-49. See also Kamanin, *Skrytiy kosmos: 1964-1966*, p. 222, in which the author refers to Korolev's visit to the Likhachev Plant to see a model of the lunar rover.

Thus, in May 1965, all documentation and research on the rover ended up in Chief Designer Babakin's lap.

Babakin had had an interesting career. A completely self-taught engineer who received his college degree at the age of forty-three, he was an unusually gifted researcher who held a particular disdain for formal educational learning. He briefly worked at the famous NII-88 from 1949 to 1951, where he first met Korolev. He spent the next fifteen years designing high-priority missiles, including the infamous Burya intercontinental cruise missile at OKB-301 in Khimki under Chief

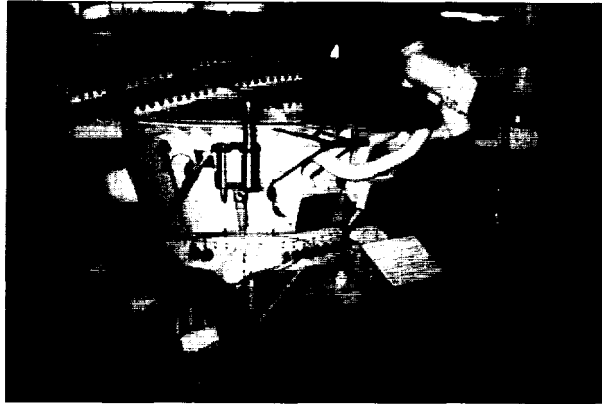

The Ye-8 rover appears here in its final design incarnation in 1971 by which time it was publicly known as Lunokhod. The two square objects in front are cameras while the container at the top front with the lid open is a laser reflector built by the French (copyright Quest magazine)

Designer Semyon A. Lavochkin. By 1960, he had risen to the post of deputy chief designer for guidance systems. For a few years in the early 1960s, Babakin worked for Chelomey, when the Lavochkin firm came under the Chelomey's control. When Chelomey lost control of his empire, Babakin rose to the top of the Lavochkin design bureau, at the exact same time that Korolev transferred all automated deep space probes to the organization. He was fifty years old at the time.

Babakin and Kemurdzhian opted to start from scratch on the rover design. By this time, the rover had been renamed Ye-8. To a certain extent, the redesign was dictated by the switch in launch vehicles to Chelomey's UR-500K booster in late 1965. Just like the L1 circumlunar project, the latter would use the Blok D translunar-injection stage to boost the rover to the Moon. More modifications came from data on the lunar soil received from the Luna 9 soft-lander probe. The firmness of the soil as well as the thinness of the dust layer led designers to drop the caterpillar track in favor of eight small wheels for movement. Babakin finished and signed the draft plan for the Ye-8 in the fall of 1966.⁴² One of the lead designers of this first mobile probe on the Moon was Oleg G. Ivanovskiy, a veteran from the Korolev days. He had served as the "lead designer" of the Vostok spacecraft and early lunar probes until June 1961, when he left engineering to become the space department head at the Military-Industrial Commission. There for five years, he was responsible for a variety of important tasks, including preparing long-range space goals. In November 1965, he returned to designing as a deputy chief designer responsible for lunar probes at the Lavochkin design bureau."

⁴¹ Babakin Banketov and Smorkalov G N Babakin pp 25-29 B Ye Chertok *Rakety i lyudi* (Moscow Mashinostroyeniye 1994) pp 272-73 O C Ivanovskiy and M B Faynshteyn "On the Life and Scientific Activities of G N Babakin" (English title) in B V Raushenbakh ed *Issledovaniye tvorchestva osnovopolozhnikov kosmonavtiki i yeye sovremennye problemy* (Moscow Nauka 1989) pp 29-37

⁴² Konstantin Lantratov "Anniversaries 25 Years From Lunokhod I Part II" (English title) *Novosti kosmonavtiki* 24 (November 19-December 2 1995) 70-79 Curiously one otherwise reliable source states that the first meeting at Babakin's organization to discuss the Ye-8 rover was on June 14 1967 See Babakin Banketov and Smorkalov G N Babakin p 53

⁴³ Yu A Mozzhorin et al eds *Dorogi v kosmos II* (Moscow MAI 1992) pp 13-14 O C Ivanovskiy *Naperekor zemnomu prityazhenyu* (Moscow Politicheskoy literatury 1988) p 265 There were two other deputy chief designers under Babakin V C Perminov (deep space probes) and A C Chesnokov (applied themes and satellites)

CHALLENGE TO APOLLO

Although the engineers finished the draft plan for the Ye-8 in 1966, it would be late 1967 before all the design documentation was finished, allowing for the construction of flight models. The complete Ye-8 vehicle had a mass of about 5,700 kilograms and consisted of a lander stage (the KT) and the actual rover (the 8YeL). The latter was designed to operate for three months on the lunar surface. The central components of the KT stage were four eighty-eight-centimeter-diameter spherical propellant tanks arranged in a square-shape linked by cylindrical connections. Two additional pairs of large cylindrical propellant tanks were attached vertically at the opposing sides of the central frame. These detachable tanks had mountings for antennas. One tank also had a nitrogen attitude control system, and another had attitude control sensors for the entire mission to landing. All the tanks contained the same unsymmetrical dimethyl hydrazine and nitric acid propellants, although the cylindrical ones were used only for lunar-orbit insertion and maneuvers in lunar orbit. Four short compressible landing legs were attached to the main spherical tanks, providing a maximum base of approximately four meters in diameter. Attitude control thrusters were positioned at various places, including two on a boom. A radar altimeter similar to the one on the piloted LK lander was installed between the tanks. All eight tanks fed a single engine designed by OKB-2 at Kaliningrad, designated the 11D417, with a variable thrust of 0.75 to 1.92 tons. The engine had a main exhaust supported by two verniers on each side, for use close to the surface so as not to disturb the sampling site. Four additional verniers around the periphery of the base provided stability during flight.

The KT stage was completed by the main pressurized toroidal compartment, which served not only as the primary location for all communications, data processing, and command electronics systems, but also as a platform on which the rover would be placed. The compartment also included gyroscopes for attitude reference and a set of chemical batteries for power. In addition, the stage included two sets of ramps, which would be lowered on each side of the KT following landing. Once the entire vehicle had landed, the ramps would be lowered, and the rover would track down the ramps to start its journey on the lunar surface."

The 8YeL rover, with a total mass of 756 kilograms, was placed on top the KT lander stage. It was a pressurized magnesium alloy lightweight container on wheels, with a height of 1.35 meters and a diameter of 2.15 meters across the top of the compartment. As with most Soviet deep space probes, the majority of the instrumentation was installed within a pressurized compartment (at one atmosphere pressure), which contained communications and control systems. The main chassis had a large hinged convex lid, which opened up to reveal a radiator for daylight exposure. The inside of the lid also contained solar cells for furnishing one kilowatt for the internal batteries of the rover. An additional 350 to 660 watts of power would be furnished by eleven kilograms of radioactive Polonium-210 kept at the rear of the 8YeL to ensure heat for the long lunar nights. To provide information on the rover's movement, the probe used internal gyroscopes; other sensors would cut off power in case the rover attempted to overcome dangerous slopes.

Each of the eight wheels was fifty-one centimeters in diameter and equipped with independent suspension and direct-current electric motors in the hubs, the latter developed by the Krzhizhanovich Power Institute in Moscow under A. I. Moskvitin. The width from left to right at the wheel level was 1.6 meters. The wheels were made out of fine wire mesh and had titanium blades to grip the lunar surface. The 8YeL would be capable of two forward and one fixed reverse speeds, while changes in direction would be achieved by driving the wheels on either side at different speeds or in reverse. In addition, the rover was designed so as to be able to move even if only two wheels on each side were operational. If a particular wheel got stuck, a command from Earth would release a powder charge to burst the shaft, thus making the wheel a passive component. The 8YeL rover was designed from the beginning so as to be controlled from the

ground. A five-person team (commander, driver, engineer, navigator, and radio operator) would guide the vehicle together while sitting in front of TV consoles showing views from the lunar surface. Nominal velocity on the surface of the Moon was limited to 100 to 200 meters per hour.

The rover carried four TV slow-image transmission facsimile cameras of the type developed earlier for the Ye-6-class of probes. These would be equipped to return 6,000-line images, which could be assembled into panoramas of the lunar surface. The cameras would be able to scan 360 degrees in the vertical and 180 degrees in the horizontal, thus providing side, down, and rear views. In addition, there were two TV cameras positioned at the forward end of the rover for providing stereo photographs with a 50-degree field of view. Communications for all surface operations would be via two antennas: one steerable high-gain and the other conical low-gain. All cameras were dual purpose—that is, for controlling the vehicle as well as for research on topography. Controllers would determine initial direction by using the panoramic cameras and would negotiate more precisely by the two frontally placed remaining cameras.

Among the scientific instruments eventually included on the 8YeL models built in the late 1960s was a penetrometer to test the soil's mechanical characteristics. The *Rifma* x-ray fluorescence spectrometer was for irradiating the soil and recording the induced radiation to identify elemental quantities of iron, calcium, silicon, magnesium, titanium, aluminum, and other substances. The x-ray device could also be used for measuring extragalactic x-rays.⁴⁵

The Ye-8 lunar rover probe began to figure into the NI-L3 piloted lunar mission profile as early as March 1966; it would select a suitable landing site for the Lunar Ship lander and serve as a radar beacon to allow the LK to make a precision landing at a safe landing site. In December, the Interdepartmental Scientific-Technical Council for Space Research met under Keldysh's supervision to discuss requirements for the rover mission as it related to the L3 piloted landing expedition. The council discussed two different scenarios: a "realistic" one, with the rover having a lifetime of two to three months and a limited radius of operation, and an "unrealistic" one, with the rover having a lifetime of a year and a radius of operation extending to 500 kilometers. Discussions also centered around formulating a specific sequence of launches for the rover in conjunction with the NI-L3. Curiously, the Soviet press was uncharacteristically forthcoming about the rover project. On August 20, 1966, a commentator on Radio Moscow told his listeners, "Soviet experts are designing an automatic mobile station to place on the Moon."⁴⁶

By early 1967, the NI-L3 profile had expanded into a highly complex plan with a flotilla of support missions, most designed to compensate for the poor capabilities of the L3 complex. The first lunar landing mission would be preceded by the launches of two Ye-8LS robot lunar orbiters, which would take detailed high-resolution photographs of the proposed landing sites. The photographs would allow scientists to select two landing sites: a primary one and a reserve one. Once the landing sites were determined, the Soviets would launch two separate Ye-8 rovers within a week of each other on top of UR-500K-Blok D boosters from Tyura-Tam. The rovers would land at the primary and reserve landing sites, respectively, making sure that the specific areas of landing would not pose hazards to the piloted lander. Teams on Earth would control both rovers by remote control.

45. *Ibid.*, pp. 63-64; Christian Lardier, *L'Astronautique Soviétique* (Paris: Armand Colin, 1992), p. 269; Lantratov, "Anniversaries: 25 Years From Lunokhod-1: Part II"; Kenneth Gatland, *Robot Explorers* (London: MacMillan, 1972), pp. 153-57. Note that the data refer to the final version of the 8YeL in 1967-68. In 1966, the mass of the rover was limited to only 650 kilograms.

46. *Soviet Space Programs, 1966-70: Goals and Purposes, Organization, Resources, Facilities and Hardware, Manned and Unmanned Flight Programs, Bioastronautics, Civil and Military Applications, Projections of Future Plans, Attitudes Toward International Cooperation and Space Law*, prepared for the Committee on Aeronautical and Space Sciences, U.S. Senate, 92d Cong., 1st sess. (Washington, DC: U.S. Government Printing Office, December 1971), p. 363.

A month or two later, the NI would be launched with a working L3 complex, the latter including a LOK orbiter and the Reserve Lunar Ship (LK_R). The LK_R would land automatically at the site of the reserve Ye-8 rover using radio beacons to guide it to a precision landing, thus saving the lander's precious propellant supply. The automated LOK would photograph the landing site from lunar orbit and return to Earth. The Ye-8 rover would then reconnoiter around the LK_R, taking photographs of all sides of its exterior and relaying back TV pictures, thus making sure that there had been no damage during landing. Only after an analysis that the LK_R was indeed in working condition would preparations begin for launching the actual L3 complex for the piloted landing. This launch would take place during the following lunar launch window after the landing of the LK_R—that is, after about a month. The second NI-L3 would carry out its flight as per the nominal mission profile, with the flight engineer remaining in orbit in the LOK and the commander landing on the Moon in the LK. The actual landing would be effected by using radio beacons from the Ye-8 rovers on the surface of the Moon. The landing was to take place as close as possible to the LK_R. The rovers would once again examine the primary LK to ascertain whether the lander was in good external condition for takeoff. If there was no damage, the lone cosmonaut would be allowed to disembark and step onto the surface of the Moon. A nominal EVA would last about two hours, while the total stay on the Moon would be limited to six hours.

In case the primary LK was damaged, the cosmonaut would have to get to the LK_R and lift off in that spacecraft. Because the Soviets were less than confident that the two landers could be landed within walking distance of each other, the Ye-8 rovers would serve as transport vehicles if the connecting distance was too far. The rovers would be equipped with reserve oxygen, allowing the cosmonaut to connect the *Krechet-94* suit to the rover's internal supply. In addition, there would be a small platform for securing the cosmonaut in a standing position for travel from one lander to the other. The cosmonaut could control the movement of the rover via a control panel, allowing a top speed on the surface of 1.2 kilometers per hour. After arrival at the LK_R, the cosmonaut would board it and take off to enter lunar orbit. The remainder of the mission would be identical to the standard NI-L3 lunar profile."

There were two more support programs to the NI-L3 landing mission. The first involved mapping mass concentrations on the Moon that profoundly affected lunar-orbital trajectories, and the second was to support reliable communications at lunar distances. Both objectives could be achieved with the use of robotic lunar satellites. Even before these requirements had surfaced, Babakin's team had already begun developing a series of small probing lunar satellites. The first model, the Ye-6S, was built almost accidentally. When the Voskhod 3 mission was postponed, the Communist Party was left without a spectacular space mission to celebrate the 23rd Congress of the Communist Party in Moscow in March 1966. Babakin proposed that he could launch a modest satellite to the Moon if given a month. His engineers used the basic Ye-6 bus to create the Ye-6S probe, which was designed, developed, and built in less than thirty days and launched on March 1. A failure in the guidance system of the Blok L stage prevented the mission's completion, but an identical probe was launched a month later on March 31 and named *Luna 10*. On April 3, *Luna 10* became the first artificial satellite of the Moon. Immediately after the Internationale, the anthem of the Communist Party, was played aboard the probe and beamed back directly to the Kremlin Palace of Congresses where the 23rd Congress of the Party was in session. Assembled delegates stood at attention as the anthem was played."

47. K. Lantratov. "Anniversaries: The 'Deceased' Lunar Plan" (English title). *Novosti kosmonautiki* 14 (July 2-15, 1994) 60-61

48. A. Tarasov. "Missions in Dreams and Reality" (English title). *Prauda*, October 20, 1989, p. 4; *Soviet Space Programs, 1966-70*, p. 17; Babakin, Banketov and Smorkalov, G. N. Babakin pp. 42-43. Although only two Ye-6S spacecraft were launched, there were apparently a total of five ordered for manufacture by MOM Minister S. A. Afanasyev on February 11, 1966.

The Luna 10 craft was shaped similar to Luna 9, except the lander was replaced by a 245-kilogram orbiter. Although the orbiter had no imaging capability, it relayed micrometeoroid, gamma-ray, infrared, and radiation data from near-Moon space for fifty-six days. Scientists also gathered important information on the pattern of the Moon's gravitational field based on orbital tracking. Radiation detectors revealed that the Moon had no trapped radiation belts comparable to those around Earth." The success of Luna 10 allowed Babakin's engineers to design a dedicated probe primarily to take photographs of the surface of the Moon, the Ye-6LF, two of which were launched in August and October 1966 as Luna 11 and Luna 12, respectively. Both carried cameras for surface photography, although the first failed to return any usable images because of malfunctions in the spacecraft's stabilization engines, which sent the spacecraft into a spin.⁵⁰ They also carried the R-1 unit for checking the action in vacuum of motors similar to the ones designed to turn the wheels of the Ye-8 rover.

Tracking during the Luna 10 mission had proved that the Moon had a very heterogeneous gravitational field. For Luna 12, ballistics experts on the ground had predictions for its orbit around the Moon for a six-month period based on prior information. But during the course of the mission, its perilune reduced by three to four kilometers per day, contrary to predictions. A failure in one of the attitude control engines of the probe prevented changing the perilune of the spacecraft. The data gathered during the mission, however, served as a starting point to design and develop a new model of a lunar satellite, one of whose mission goals was to study the Moon's gravitational field to make precise determinations of trajectories for the various elements of the N1-L3 lunar landing plan. Babakin's team began development of the Ye-6LS in late 1966, which also had the dual purpose of testing the Soviet deep space communications network.

Tracking for the Moon

The Soviet tracking and telemetry network, known officially as the Command-Measurement Complex, had grown in steps and bounds since its early days in the late 1950s. Approximately fifteen stations, referred to as Scientific-Measurement Points (NIP), were located throughout the contiguous USSR, serving as stations for use during Earth-orbit and deep space missions, both piloted and automated. The ground stations were augmented in the mid-1960s by the third generation of Soviet tracking ships. In 1965 and 1966, the new *Ristna* and *Bezhitsa* replaced the older *Ilichevsk* and *Krasnodar*. Later in 1967, four new ships were introduced—the *Kegostrov*, the *Nevel*, the *Morzhovets*, and the *Borovichi*—each with a displacement of 6,100 tons and a crew of thirty-six." The same year, all the ships were officially turned

49 Wilson *Solar System log* pp 35-36

50 The Ye 6LF probes were designed to take photographs in two regimes (1) photographing in a stabilized mode from the perilune immediately after the satellite braked into lunar orbit and (2) in slow rotation conditions when oriented relative to the Sun. The failure on Luna 10 was due to "uncompensated parasitic moments" in the stabilization engine system. See Babakin Banketov and Smorkalov *G N Babakin* pp 45-46. A document dated circa 1965 from Keldysh and Babakin to the government proposing the Ye 6LF program has been published as M V Keldysh and G N Babakin "On Photographing the Lunar Surface with Artificial Satellites of the Moon" (English title) in Avduyevskiy and Eneyev eds *M V Keldysh* pp 480-81.

51 Babakin Banketov and Smorkalov *G N Babakin* pp 46-48. Both the Luna 11 and Luna 12 spacecraft also had extensive supplementary scientific instruments aboard. The latter carried a gamma ray detector, a magnetometer, radiation detectors, an infrared radiometer, and meteoroid detectors. Luna 12 detected x-ray emissions from the Moon's surface as a secondary effect of fluorescence under solar x-ray emission. The Soviets later claimed that this was the "birth of x-ray astronomy." See G V Petrovich ed *The Soviet Encyclopaedia of Space Flight* (Moscow: Mir Publishers, 1969) p 45. Contact was lost with Luna 11 on October 1, 1966, and with Luna 12 on January 19, 1967.

52 Jacques Villain ed *Barkonour la porte des étoiles* (Paris: Armand Colin, 1994) p 92. B A Pokrovskiy "Zarya"—*pozyunoye zemni* (Moscow: Moskovskiy rabochiy, 1987) p 254.

over to the Department of Naval Expeditionary Work of the Academy of Sciences, although it seems that the "civilian" tag was somewhat of a misnomer because much of the on-board personnel were military servicepersons." The Soviets depended to a great extent on these ships, partly because overflying satellites were in direct visibility of ground stations only nine out of twenty-four hours on the average. In addition, unlike NASA, the Soviets had less luck placing stations in foreign countries, although stations were established in Chad, Cuba, Guinea, Mali, and the United Arab Emirates in 1967-70.⁵⁴ The locations in Africa were evidently built specifically for piloted lunar programs because they would be on the ground track for return trajectories from lunar distances.

All the ground stations of the Command-Measurement Complex were under the direct control of the Strategic Missile Forces via military unit no. 32103. This unit, commanded by Maj. General Ivan I. Spitsa since March 1965, had emerged from the auspices of the military NII-4, located in Bolshevo outside Moscow. Since the early days of the ICBM program, NII-4, which was subordinated to the Strategic Missile Forces, was responsible for coordinating tracking and communications with space satellites via its numerous tracking stations across the Soviet Union. In December 1957, NII-4 moved its control center from Bolshevo to Moscow, and in January 1963, this control center was removed from NII-4's jurisdiction and subordinated directly to the General Staff of the Strategic Missile Forces as military unit No. 32103." The Moscow location was the central control node for the early Soviet space program, supporting all communications with robotic and piloted satellites in space.

Unlike NASA, however, the Soviets did not have a dedicated mission control facility for piloted missions until well into the early 1970s. Instead, each mission had its own customized chief operations and control group (GOGU), somewhat analogous to the Western concept of a flight control team, which maintained control over all flight operations, such as docking, EVA, reentry, and so forth. The GOGU was staffed by approximately ten representatives from the design bureaus, the military, the production plants, and the Academy of Sciences.⁵⁶ By the time of the early Soyuz missions, the GOGU oversaw up to about 500 individuals, who worked around the clock in three shifts. If there were specific technical issues or problems, specialists from the relevant design bureaus were invited to participate in the operations of the GOGU. Up until 1966, Colonel Amos A. Bolshoy, an officer in the Missile Strategic Forces, led the GOGU for all piloted missions. For a particular flight, the GOGU was given access to the military Command-Measurement Complex, and depending on the circumstances surrounding the mission, the GOGU could be based at one of several locations, including NII-4's Moscow branch (for Vostok missions) or the Ministry of Defense's General Staff control center, also in Moscow (for Voskhod missions). Because the Vostok and Voskhod missions were relatively short, State Commission members usually never departed the launch site at Tyura-Tam after

53 The commander of the Department of Naval Expeditionary Work (OMEP) was Rear Admiral I. D. Papanin who served in that capacity from 1951 until his death in 1986.

54 *Soviet Space Programs 1976-80 Supporting Vehicles and Launch Vehicles Political Goals and Purposes International Cooperation in Space Administration Resource Burden Future Outlook* prepared for the Committee on Commerce Science and Transportation U.S. Senate 97th Congress 2d sess. (Washington DC: U.S. Government Printing Office December 1982) p. 124.

55 K. V. Gerchik ed. *Nezabyvayemyy Baykonur* (Moscow: Interregional Council of Veterans of the Baykonur Cosmodrome 1998) p. 379. See also B. A. Pokrovskiy *Kosmos nachnayetsya na zemlye* (Moscow: Patriot 1996) p. 272. For military unit No. 32103 see Semenov ed. *Rakelno Kosmicheskaya Korporatsiya* p. 35.

56 For the early Soyuz missions the GOGU included nine men: P. A. Agadzhanov (TsKBEM), S. N. Anokhin (TsKBEM), B. Ye. Chertok (TsKBEM), K. P. Feoktistov (TsKBEM), G. I. Levin (NII-4), Pavlov (affiliation unknown), B. V. Raushenbakh (TsKBEM), M. S. Ryazanskiy (NII Priborostroyeniya) and Ya. I. Tregub (TsKBEM). See Chertok *Rakety i lyudi goryachye dni kholodnoy vojny* p. 422.

liftoff. Thus, for these early flights, senior officials such as Korolev, Keldysh, or Tyulin would remain at Tyura-Tam and maintain a constant communications link with the Moscow center, which itself maintained contact with the Command-Measurement Complex. The nerve center at Tyura-Tam was usually at site 2 on the second floor of the giant Assembly-Testing Building in the offices of Maj. General Anatoliy S. Kirillov, the famous chief of the First Directorate at the launch range during the early 1960s.⁵⁷

With the commencement of the Soyuz program, officers of the Strategic Missile Forces proposed moving the main control center for piloted missions to a dedicated facility, the Scientific-Measurement Point No. 16 (NIP-16) at Yevpatoriya in Crimea. NIP-16 thus became the second-generation Soviet flight control center, at which the GOGU controlled almost every single Soviet piloted mission from 1966 to 1975. By 1966, the first-generation flight control centers, at NII-4 and the General Staff, were, for the most part, turned over to control automated military satellites.

NIP-16 had originally been built in the late 1950s as a modest station for receiving telemetry from overflying satellites, but its central role in the Soviet space program grew dramatically during the early 1960s. In 1959, when OKB-1 first began developing interplanetary spacecraft to fly to Mars and Venus, Korolev and Keldysh proposed a dedicated site to build a deep space tracking station. The designers had a deadline of just eight months. A special commission quickly selected Yevpatoriya on the shore of the Black Sea. The future facility was named "Object MV" to denote its role in tracking spaceships to Mars and Venus, although it was rumored that the "MV" also stood for Mstislav Vsevolodovich, the first two names of Academician Keldysh. Korolev had initially invited Chief Designer Ryazanskiy of NII-885 to design the radio tracking systems for the facility, but he had declined, believing that it would be impossible to develop antennas capable of tracking signals from a distance of 100 million kilometers. Chief Designer Yevgeniy S. Gubenko of SKB-567 took on the job and proposed that instead of one 100-meter parabolic dish, eight sixteen-meter "bowls," designated ADU-1000, be erected at the site, providing a capability to communicate to distances of 300 million kilometers.⁵⁸

Korolev came up with an ingenious idea to mount the dishes using leftover parts from the Soviet Navy. Construction workers dug a huge crater out of the rocky ground, poured in a foundation, took the revolving gun turret of a former seafaring battleship consigned to the junkyard, and placed it on the foundation. Then the open framework of a railroad bridge was placed over the turret. The bridge itself was covered by the solid hull of a scrapped submarine. The eight antennas were fixed to this hull.⁵⁹ Eventually, the Object MV station at NIP-16 consisted of three complexes separated by several kilometers: one designed to send commands and the two others to receive incoming information. Each complex had eight antennas with a diameter of sixteen meters and a surface area of 1,000 square meters. The transmission power was rated at 120 kilowatts, and the maximum range was 300 million kilometers. The sensitivity was sufficient to detect a match struck on the surface of the Moon. The facility came on

57. *Ibid.*, pp. 413-14; Semenov, ed., *Raketno-Kosmicheskaya Korporatsiya*, pp. 351-53.

58. Pokrovskiy, *Kosmos nachinayetsya na zemlye*, pp. 309-12; B. Ye. Chertok, *Rakety i lyudi: Fili Podlipki Tyuratam* (Moscow: Mashinostroyeniye, 1996), pp. 301-02. Chief Designer Ye. S. Gubenko died unexpectedly in 1959, and this work was continued by his successor, A. V. Belousev. Other enterprises involved in building the dishes included TsNII-173 (mechanical drives) and MNII-1 (systems for aiming the antennas). Note that Chertok says that the diameter of the dishes was twelve meters. Most other sources suggest sixteen meters. See, for example, Pokrovskiy, "Zarya"—*pozyunoye zemni*, p. 228.

59. B. Sopelnyak, "The Secret of Facility MV" (English title), *Krasnaya zvezda*, March 22, 1990, p. 4.

line on September 26, 1960, on a provisional standing, and it was fully operational by December 30.⁶⁰

The Yevpatoriya station was supported by several "ballistics centers." These were located at NII-4, at the Institute of Applied Mathematics of the Academy of Sciences in Moscow, at the Central Scientific-Research Institute for Machine Building in Kaliningrad, and at Yevpatoriya itself, for computing all trajectories, orbits, flight parameters, and so forth. The facilities at Yevpatoriya were relatively primitive. Mission controllers had no real-time visual depictions of mission parameters, such as at NASA's much more modern Manned Spacecraft Center in Houston, Texas. The primary mode of communications between the centers and spacecraft were, in fact, old-style telephone and telegraph systems, scrambled to maintain secrecy.

In 1966, Maj. General Pavel A. Agadzhanov, a deputy commander of military unit No. 32 103, began his tenure as the head of the GOGU—that is, the "flight director" of Soviet piloted space missions. An amateur radio enthusiast in his youth, he joined NII-4 in 1948 and contributed to the development of tracking networks at Kapustin Yar, Tyura-Tam, and eventually the space Command-Measurement Complex. Based on this work, Agadzhanov earned his Ph.D. in the late 1950s, and he moved into ballistics computation work for the Soviet ground communications segment." For the top-secret piloted lunar flights—the UR-500K-L1 circumlunar and NI-L3 landing missions—Colonel Nikolay G. Fadeyev, yet another accomplished military officer, headed flight operations in the late 1960s.⁶²

The GOGU controlled the missions via the military officers of the Command-Measurement Complex, but the GOGU itself was subordinated to the temporary State Commission, which would receive recommendations from the GOGU, make decisions based on these communications, and then recommend courses of actions. The GOGU would also maintain constant contact with "backup" centers: Group T at Tyura-Tam and Group M at NII-4. TsKBEM played a major role in the operation of the GOGU, because its "technical leader" (the "deputy flight director") was usually a civilian deputy chief designer from the design bureau. This post was occupied by Boris Ye. Chertok from 1966 to 1968 and Yakov I. Tregub from 1968 to 1973.⁶³ This management hierarchy, in which a military officer headed flight control while his principal



Pavel Agadzhanov was the "flight director" for Soviet piloted space missions during the late 1960s. His early career had been at the military NII-4. Later, he served as a deputy chief of the

Command-Measurement Complex, the Soviet tracking network (views of Peter Gorin)

60 Pokrovskiy 'Zarya'—*pozyvnoye zemni* p 227 i Meshcheryakov 'The Center for Long Range Space Communications' (English title) *Aviatsiya i kosmonavtika* no 6 (June 1988) 42-43 Object MV was augmented in 1979 by the seventy meter diameter RT 70 radio telescope which allowed spacecraft tracking to extend to 1.5 billion kilometers. The RT 70 was designed by NPO Radiopribor (formerly NII 885). Three other large dishes for the deep space communications network were designed and built by the OKB of the Moscow Power Institute (OKB MEI). These included two dishes (twenty five and thirty two meters) at Crimea and one dish (sixty four meters) at Medvezhiy Lake near Moscow. The twenty five meter dish was evidently located at NIP 10 in Simferopol. See Chertok *Rakety i lyudi Fili Podlipki Tyuratam* p 301 A. V. Ponomarev '2 June—75 Years From the Birth of Academician A. F. Bogomolov (1913)' (English title) *Iz istorii aviatsii i kosmonavtiki* 59 (1989) 47-50.

61 Pokrovskiy *Kosmos nachinayetsya na zemlye* pp 114-116 Semenov ed *Raketno Kosmicheskaya Korporatsiya* p 355.

62 Pokrovskiy *Kosmos nachinayetsya na zemlye* pp 279-80 Semenov ed *Raketno Kosmicheskaya Korporatsiya* p 355. There was a third GOGU chief during the period 1966-73. Colonel M. S. Posternak.

63 Semenov ed *Raketno Kosmicheskaya Korporatsiya* p 355. Whereas at first the GOGU was established unique to each mission starting in 1968. Chief Designer Mishin established a specialized control subdivision in Tregub's testing department at TsKBEM to focus exclusively on mission control.

assistant was a civilian from the design bureau, was symptomatic of all flight control teams. It underscored not only the deeply enmeshed military nature of all Soviet space programs, but also the decades-long aftereffects of the actions of artillery officers who had pragmatically taken operational control over missile projects during the late 1940s. Ironically, Tregub had started his career as an artillery officer overseeing the early A-4 and R-1 launches from Kapustin Yar. He later moved on to direct launches of air defense and anti-ballistic missiles for the Soviet military during the 1950s and 1960s. In 1964, Korolev had invited him to join OKB-1 as the deputy chief designer responsible for flight testing.

The Rise and Fall of the UR-700

Through the mid-1960s, in the post-Korolev era, General Designer Vladimir N. Chelomey continued to push his own conception of a piloted lunar landing project. This proposal, involving the giant UR-700 booster, had gained ground in 1964 when Khrushchev had suggested that scientists carry out a detailed appraisal of the costs and advantages of the UR-700 over the N1 plan. Despite Khrushchev's ouster, Chelomey lined up a formidable array of supporters, including Chief Designers Glushko, Kuznetsov, and Barmin. By October 1965, the Ministry of General Machine Building had approved the development of a predraft plan at TsKBM. Perhaps realizing the absurdity of the situation, Korolev had evidently authored a letter to Minister Afanasyev, requesting that the government not waste money on duplicating the N1-L3 project. The letter never reached Afanasyev; days after preparing it, Korolev was dead.

Chelomey's engineers at his Branch No. 1 at Fili approached the UR-700 effort with some amount of humor. There was evidently a joke making the circles at the design bureau that because Korolev had died, his subordinates could not be expected to make anything out of the "hopeless" characteristics of the N1. Therefore, Chelomey's engineers were acting only out of kindness by offering "humanitarian" aid in the form of the UR-700.⁶⁴ Because they were working in a less-than-favorable post-Khrushchev climate, Chelomey's deputies developed a technical plan that significantly reduced cooperation with outside subcontractors and relied heavily on internal expertise. In addition, the actual design of both the UR-700 booster and its lunar payload, designated the Lunar Ship No. 700 (LK-700), was derived from already existing designs to minimize long lead times for development. "TsKBM completed the predraft plan (the mechanics of the proposal) for the UR-700 and its LK-700 lander in August-September 1966."⁶⁵ The achievement of this milestone served as a catalyst for action from the government. Minister Afanasyev finally fulfilled the deposed Khrushchev's original command by issuing an order on September 17, 1966, for the formation of a commission to conduct a comparative study between the UR-700 and the N1-L3 on "the reasonability of proceeding with further works on those projects."⁶⁷

The "expert commission" to compare the UR-700/LK-700 and the N1-L3 proposals was headed by the ubiquitous Academician Keldysh. According to one observer, most of the thirty-four members of the commission were sympathetic to the late Korolev. Chelomey's relation-

⁶⁴ Rudenko 'Designer Chelomey's Rocket Planes'

⁶⁵ Sergey Khrushchev *Nikita Khrushchev: krizisy i rakety vzglyad iznutri tom 2* (Moscow: Novosti 1994) p. 518

⁶⁶ Rudenko 'Space Bulletin: Lunar Attraction Historical Chronicles' (English title) *Vozdushnyi transport* 24 (1993) 11. One source states that in August 1966 "the predraft plan for the piloted ship for circling the Moon of the type LK-3 and the piloted ship for landing on the Moon LK-700 was finished." The source also implies that in September 1966 "the work on the mechanics of the proposal for the UR-700 rocket carrier planned for landing the LK-700 piloted apparatus on the Moon" was finished. See Mikhail Rudenko 'Space Bulletin: Lunar Attraction Historical Chronicles: First Publication' (English title) *Vozdushnyi transport* 27 (1993) 8-9

⁶⁷ Vetrov interview, November 15, 1996. Georgiy Stepanovich Vetrov 'Development of Heavy Launch Vehicles in the USSR' presented at the 10th International Symposium on the History of Astronautics and Aeronautics, Moscow State University, Moscow, Russia, June 20-27, 1995.

ship with Keldysh had also evidently soured despite the latter's occasional support." In late October 1966, Minister Afanasyev, accompanied by the commission, visited both TsKBM and TsKBEM to assess the pros and cons of both projects as explained by their respective creators.⁶⁹ Chelomey had set up a stunning display of posters in his huge sixth floor office room at Reutov, and the commission spent the day asking detailed questions. The visit to Mishin's design bureau differed only in the use of models instead of posters. Afanasyev was evidently uncertain of which project to favor. By this point, Chelomey felt that he was fighting a losing battle because Mishin had the backing of Keldysh and Ustinov. He told one of his assistants, "I don't want to fight with [the commission]."⁷⁰ He wanted instead to concentrate his time and resources on the UR-100 ICBM project, one of his few bright prospects for the future. Finally, on November 16, 1966, Chelomey presented the basic technical details of his competitive lunar landing proposal at a plenary session of "the advisory council reviewing the course of work being done in the NI-L3 program."⁷¹

The origins of the UR-700 booster can be traced back to 1961, when Chelomey tasked his Branch No. 1 to explore possible designs for a booster capable of lifting approximately seventy tons to low-Earth orbit. Serious work on the concept did not, however, begin until the collapse of the LK-1 circumlunar plan in 1965. Chelomey was also inspired to pursue the idea from Yangel's defunct heavy-lift R-56 rocket project offered briefly as a competitor to the NI-L3 program. Perhaps he did not want to be left out of this mother lode of space projects. Chelomey made sure that his UR-700 proposal would have radical differences with Korolev's NI-L3: if the two projects were only marginally dissimilar, any evaluation commission would have little reason to pick the UR-700 over the NI. Like a good politician, he made sure that the UR-700 proposal was not just incrementally, but significantly more superior to the NI project in every relevant parameter.

When Chelomey formally presented his UR-700 lunar landing project in November 1966, he emphasized five major requirements for the overall plan, which he believed would give it the advantage over his principal competitor:

- His design bureau and only his design bureau, TsKBM, would be the primary contractor for the project. Mishin's TsKBEM would be completely excluded from any participation in the work.
- All subcontractors working on the NI-L3 should redirect all their work to the UR-700 project. (In addition, all ground equipment developed for the NI-L3 would be used for the UR-700 with minimum updating.)
- The UR-700 project could be accomplished in the shortest time possible with the most minimum of expenditures. Curiously, Chelomey made no mention whatsoever of a competition with Apollo: apparently, Chelomey believed that even in the most favorable of circumstances, the first landing mission would mostly likely be after an Apollo landing.
- All stages of the UR-700 and its LK-700 would use storable propellants (nitrogen tetroxide and unsymmetrical dimethyl hydrazine).
- All of the manufacturing of the UR-700 and the LK-700 would be carried out at TsKBM and its affiliate M. V. Khrunichev Machine Building Plant in Moscow.

68. Khrushchev, *Nikita Khrushchev*, tom 2, p. 519.

69. Rudenko, "Designer Chelomey's Rocket Planes."

70. Khrushchev, *Nikita Khrushchev*, tom 2, p. 521.

71. I. B. Afanasyev, "Unknown Spacecraft (From the History of the Soviet Space Program)" (English title). *Nouoye v zhizni Nauke. tekhnika Seriya kosmonautika, astronomiya* no. 12 (December 1991): 1-64

For the UR-700 launch vehicle in particular, there were four design specifications:

- The booster would launch a payload about one and a half times the mass of the L3 payload of the NI rocket.
- The booster would be built on the "block" principle—that is, its separate blocks could be transported by rail and assembled at the launch site. These blocks would be based in design on the individual rocket units of the smaller Proton booster.
- The booster would have a minimum number of stages and engines to increase reliability. The engines of the lower two stages would have very high thrusts per combustion chamber.
- Booster staging would be designed with a composite layout in mind—that is, the first stage would be connected in parallel like strap-ons, and the second and third stages would be linked in tandem.

The LK-700 lunar landing payload had two major requirements:

- Because of the selection of a direct ascent, the LK-700 would have a launch mass of one and a half times as much as the L3 payload.
- The design of the LK-700 would be such that maximal use would be made of already created space vehicles. This would significantly reduce development time. Engineers would make good use of already-built robotic spacecraft such as the "IS" and the "US," the abandoned piloted Raketoplan and LK-1 projects, and the UR-100 ICBM."

In exploring various concepts of the LK-700 lunar landing spacecraft, Chelomey proposed using a "direct ascent" mission profile: it dispensed with both lunar-orbit rendezvous and Earth-orbit rendezvous. In the United States, NASA had foregone direct ascent in favor of lunar-orbit rendezvous in 1962, while Korolev's camp in the Soviet Union had done the same in 1964. Chelomey, however, did not want to deal with complex docking operations, which might introduce weak links in the system as a whole. His engineers also believed that a direct ascent profile would allow a wide range of landing sites on the Moon, up to as much as 88 percent of the lunar surface, as opposed to lunar-orbit rendezvous, in which landing sites would be limited only to the equatorial regions. A direct ascent profile necessitated the use of a very heavy launch vehicle—one with a lifting power about one and a half times more than that of the NI. Payload capability to Earth orbit of the UR-700 was in the range of 145 tons, sufficient for a translunar-injection stage, a lunar braking stage, and a large lunar lander. The mass of the latter two components—that is, the mass injected on an escape trajectory—was approximately fifty tons." The increased mass of the lander would allow a crew of two persons to land on the Moon, unlike the L3's one cosmonaut. Two cosmonauts on the ground afforded significantly increased levels of safety and more scientific research. With high-energy stages, this number could be increased to three during later missions.

Unlike the NI-L3 plan, Chelomey outlined an extensive program of scientific research for his new project, to be carried out both en route to the Moon and on its surface. This program would include:

72 E-mail correspondence, Igor Afanasyev with the author, December 16, 1997.

73. The mass of 145 tons is from N. Kamanin, "A Coal Worth Working for" (English title), *Vozdushniy transport* 45 (1993): 8-9. Other figures have also been quoted, including 130 tons and 150-151 tons. For the former, see Afanasyev, "Unknown Spacecraft - For the latter, see V. Karrask, O. Sokolov, and V. Shishov, "Known and Unknown Pages of the Russian Khrunichev Center's Space Activity," presented at the 47th Congress of the International Astronautical Federation, Beijing, China, October 7-11, 1996.

- Research on radiation conditions in space
- Studies on micrometeoroids in space
- Research on solar plasma
- The study of the lunar surface for identifying optimal landing sites and refining selenographic coordinates for purposes of navigation
- The collection of samples from the Moon at various depths
- Passive seismographic studies on the Moon
- Measurements of lunar surface temperatures
- Studies of lunar soil properties by spectroscopy
- Research on cosmic rays
- Research on electrical potentials in lunar soil caused by natural magnetic fields
- A precise determination of the Moon's movement relative to Earth with the use of lasers delivered to the Moon
- The study of variations in the lunar gravitational field
- Research on variations of the lunar magnetic field
- Extensive surface photography⁷⁴

In making his report, Chelomey also offered up the somewhat ambitious prospect of gearing all UR-700 landing missions such that they would eventually lead to the establishment of permanent bases on the Moon. Initial landing sites would be chosen for their possible use as future "colonies." Work on these future prospects would be aided by Ye-8 robotic rovers on loan from the Lavochkin organization.

From a hardware perspective, the UR-700 booster was a behemoth. On the pad, the complete booster-payload stack would be approximately seventy-six meters in length (including the standard launch escape tower) and have a base diameter of about seventeen and a half meters (excluding four large aerodynamic stabilizers for use during the active portion of the ascent trajectory). For engines on the rocket, Chelomey had initially contracted his favorite subcontractor, Chief Designer Kosberg. In 1962, Kosberg's design bureau, OKB-154, had begun work on a 250-ton engine, the RD-0215. A number of other research organizations, including the Central Institute of Aviation Engine Building, the Scientific-Research Institute of Thermal Processes, and the All-Union Institute of Aviation Materials, were involved in the early work on the engine, which was the most powerful engine Kosberg had ever designed. Using technologies derived from engines of the UR-200 ICBM, in two years, Kosberg's engineers prepared a large volume of ground equipment for testing the unit at its own manufacturing plant. Two initial engines were built, one for cold testing and one for ground firings." In 1965, Glushko stepped in. For several years, he had been working on a giant 680-ton (vacuum) thrust engine for possible use on a future Soviet booster. When Korolev rejected all his overtures to use this engine on the NI, Glushko turned to Chelomey and convinced the latter that his RD-270 would be a better choice for the UR-700 than Kosberg's RD-0215. All work on the Kosberg engine was terminated immediately.

The cooperation with Glushko led to two variants of the UR-700: one with a multitude of RD-253 engines, identical to the ones used on the first stage of the more famous UR-500K (or Proton) booster, and the second one with the massive RD-270s." This second version of the rocket was a three-stage monster that dwarfed the NI in size. Compared to the NI-L3's total mass of 2.750 tons, the UR-700/LK-700 would weigh a whopping 4.820 tons at launch. Its mass was more comparable to the giant Nova studies pursued by NASA in the early 1960s before the decision in favor of the Saturn C-5. The new system's specifications were:

74 Afanasyev correspondence, December 16, 1997

75 KB *KhimAutomatiki Stranitsy istorii tom I* (Voronezh: KB KhimAutomatiki, 1995), pp 57-58

76 Vetrov, "Development of Heavy Launch Vehicles"; Telephone interview, Sergey Nikitich Khrushchev with the author, October 10, 1996. Lt. General N. P. Kamanin wrote in his journal entry for December 28, 1966, that "the first and second stages of the UR-700 are basically the same as those of the UR-500." It is possible that he was referring to the first variant of the UR-700 using the RD-253 engines. See Kamanin, "A Goal Worth Working for "

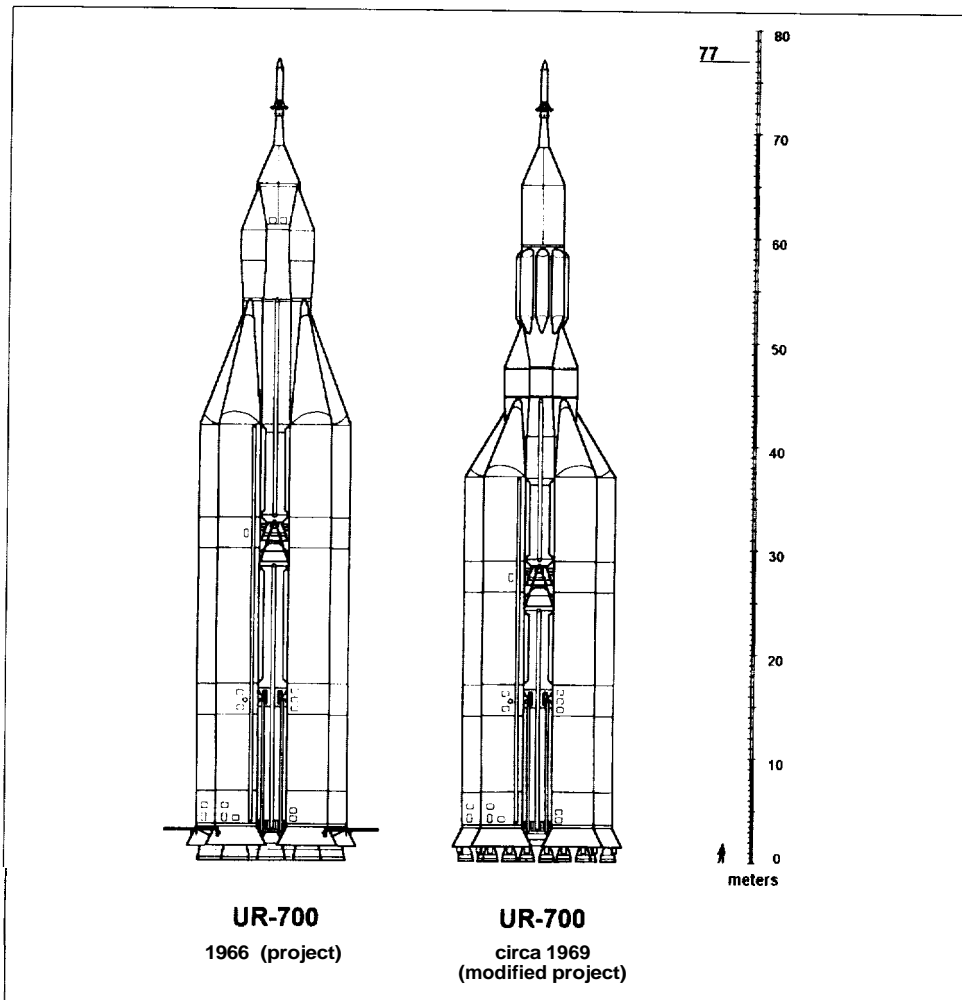

Shown are two variants of Chelomey's UR 700 booster from 1966 and circa 1969 (copyright Peter Corin)

Stage	Engines	Thrusters	Total Thrusts
Stage I	Nine RD-270s	640 tons each (sl)	5,760 tons (sl)
Stage II	Three RD-270s	680 tons each (v)	2,040 tons (v)
Stage III	Three RD-254s	170 tons each (v)	510 tons (v) ⁷⁷

The third stage's RD-254 engines were merely altitude versions of the Proton's RD-253 units.

In terms of design, the UR-700 held a superficial resemblance to the Proton and Vostok boosters, in that it looked like a core booster surrounded by strap-ons. The arrangement and use of the core and strap-ons were, however, vastly different. In the UR-700's case, Chelomey's engineers used both a tandem and a parallel strap-on scheme on the same booster. The core

⁷⁷ E-mail correspondence Igor Afanasyev with the author. December 17 1997

of the launch vehicle—the second stage—consisted of a two-stage booster. The lower portion was a cluster composed of three long cylindrical modules, each with a diameter of just over four meters, which was a limit from a rail transport perspective. These modules were derived from the same tanks used on the Proton booster. Each module was equipped at the base with a single RD-270 engine. The upper portion of the core consisted of three smaller diameter cylindrical tanks clustered together, each with a single RD-254 engine.

The core was surrounded through its entire length by three clusters, each with two identical cylindrical modules. This set of six cylinders was known collectively as the first stage of the booster. Like the core, the first stage also used single RD-270 engines on each module. All nine modules of the first and second stages were to fire at liftoff, giving a total sea-level thrust of 5.760 tons, far above both the NI (4,620 tons) and the Saturn V (3,404 tons). The effectiveness of the excessively high thrust was tempered to a great degree by the use of low-performance propellants—unsymmetrical dimethyl hydrazine and nitrogen tetroxide—which significantly lowered the efficiency of the engines as compared to both its competitors. At a certain point in the trajectory, the strap-ons would be discarded, leaving the lower portion of the core to fire at a vacuum thrust of 2.040 tons. This section would eventually fall away, and the three RD-254 engines would fire at a total of 510 tons thrust to insert the 151-ton payload into Earth's orbit. Initial parameters would be 260 by 186 kilometers at a fifty-one-and-a-half-degree inclination.⁷⁸

The entire LK-700 complex was a four-stage vehicle. The first stage was for translunar injection (TLI), the second for braking prior to landing on the Moon, the third for soft-landing on the Moon, and the fourth for liftoff and direct return to Earth. Their performance characteristics were:

Stage	Purpose	Engines	Number X Thrust	Design Bureau
Stage IV	TLI	11D23	Three X 23.5 tons	Kosberg
Stage V	Lunar braking	11D23	One X 23.5 tons	Kosberg
Stage VI	Lunar landing	11D416	Three X 0.75–1.9 tons	Isayev
Stage VII	Lunar takeoff	15D13	One X 13.4 tons	Izotov

After being put on a trajectory toward the Moon, the crew would discard the heavy TLI stage weighing about 100 tons and settle into their lunar lander, which would have a mass of fifty and a half tons, en route to the Moon. During this part of the mission, mid-course corrections would be effected by small 1.67-ton-thrust verniers on the side of the spacecraft. After a three-and-one-third-day coast to the Moon, the single lunar braking engine, similar to the ones used for TLI, would fire to reduce velocity to levels safe for the initiation of lunar landing maneuvers. After the use of this engine, this stage would be jettisoned, releasing the 18.3-ton lander proper. At this point, the two-man crew would use a set of three throttleable 1.9-ton-thrust engines for hovering over the lunar surface and selecting a site. At landing, the LK-700 lander would have a mass of just over seventeen tons. For initial landing sites, Chelomey's engineers picked two possible areas stemming from two different trajectories to the Moon: the Sea of Fertility after a six-and-a-half-day flight to the Moon or the Ocean of Storms after a three-and-a-half-day flight.

The cosmonauts would spend the majority of their trip in a cone-shaped return apparatus shaped similarly to the abandoned LK-1 circumlunar ship, but scaled up in size to hold two

⁷⁸ Karrask Sokolov and Shishov "Known and Unknown Pages " The mass of the LK-700 complex on the ground was 154 tons. The three missing tons was the launch escape system, which would be discarded prior to insertion into Earth orbit.



On the right of this Russian drawing is one of the few publicly available representations of Chelomey's LK 700 lunar landing complex. The resemblance of the LK 700 to NASA's Gemini is clearly evident. Below the lander is the final stage of the UR 700 rocket. For comparison, Korolev's 13 lunar complex is shown on the left (copyright Igor Afanasyev).

cosmonauts. The link in design between the LK-1 and the LK-700 would establish a genealogy of spaceship design across several generations of space vehicles designed at Chelomey's design bureau." The return apparatus would set down on the Moon with its apex pointing upwards—looking much like an upright Apollo Command and Service Module. The crew would spend about twelve to fourteen hours on the lunar surface during early missions, sufficient for one excursion outside. At liftoff from the Moon, the cosmonauts would sever attachments to the descent stage of the LK-700 and launch from the surface using a single 13.4-ton-thrust engine firing at full thrust. Two different options were available to the crew in their 14.8-ton ascent stage: either flying directly toward Earth or entering lunar orbit and leaving for Earth at the most appropriate moment. After further mid-course corrections on the way back to Earth using three small 200-kilogram-thrust engines, the return apparatus would separate from the rest of the LK-700 spacecraft and reenter Earth's atmosphere. Looking remarkably similar to the Apollo Command Module, the 3.1-ton capsule would land by parachute on Soviet territory after a guided descent through the atmosphere. The total mission would last eight and a half days from start to finish."

79 A drawing of one variant of the LK 700 has been published in Afanasyev "Unknown Spacecraft"
 80 Afanasyev "Unknown Spacecraft" Afanasyev correspondence December 17 1997

CHALLENGE TO APOLLO

The Kosberg and Isayev design bureaus were contracted to build most, but not all, the engines for the payload. One exception was the designer for the critical ascent stage engine of the LK-700 lander, which was contracted out to OKB-117 (later the Leningrad experimental design bureau named after V. Ya. Klimov). Like many other aviation design organizations, OKB-117, headed in the mid-1960s by Chief Designer Sergey P. Izotov, was trying to diversify into the missile and space business to preclude economic collapse. Izotov had primarily been famous for designing engines for Soviet military helicopters from the Mil and Kamov design bureaus." Izotov's first foray into the missile business had been the creation of the 8D423, the second-stage engine for Chelomey's UR-100 ICBM. This single-chamber engine with a thrust of 13.7 tons also had four one-and-a-half-ton-thrust verniers.⁸² Chelomey took this engine, modified it, and used it as the liftoff engine for his LK-700 lander. This sort of appropriation and cross-pollination was symptomatic of many of the elements of the UR-700/LK-700 project, a point that Chelomey repeatedly emphasized as one of its principal advantages.

When Chelomey presented his conception of the UR-700 project in November 1966, he did not mince words or hold back. He took every opportunity to firmly criticize various aspects of the NI-L3 project, bringing the arguments down to levels that were clear to industry leaders who had little or no engineering backgrounds. He also had some key supporters in tow, including Chief Designers Clushko, Barmin, and Kuznetsov, as well as Air Force Lt. General Kamanin. According to one respected Russian space historian:

Chelomey tried to convince the leadership of the sector that with financial support and the research base that had been created in previous operations, his OKB would be able to execute the program quickly and make the USSR the first to land on the Moon. . . . The advisory council, however, considered such a declaration too bold and allowed only the performance of preliminary design work on the UR-700/LK-700 complex."

Kamanin, with his own biases against the NI, wrote in his journal in late December 1966:

Based on the UR-500 and [the UR-100] Chelomey has designed the UR-700 rocket, which has been approved by a panel of experts from the Ministry of General Machine Building, but so far the go-ahead has not been given for its implementation. Our leaders hesitate about simultaneously building Chelomey's UR-700 rocket and Korolev's NI (hundreds of millions of rubles have already been spent to build the latter). But they are oblivious to the fact that the cost of building a UR-700 will be ten times less than the amount spent to build the NI. Because the first and the second "stages" of the UR-700 are basically the same as those of the UR-500 and, besides, it can use the same assembly and test building and launch equipment as the NI. . . . One would have thought that one should go ahead with UR-700 immediately, but I. V. Smirnov and D. F. Ustinov will hardly dare to take such a step because it was they who gave the green light to the NI. . . .⁸⁴

Despite the compelling nature of Chelomey's arguments, several members of the evaluation commission were not thrilled by some of the weak links of the project, in particular the

81 A. N. Ponomarev *Sovetskiye aviatsionnyye konstruktory* (Moscow: Voennoye izdatelstvo, 1990) pp. 312-13

82 Ye. B. Volkov, ed. *Mezhkontinentalnyye ballisticheskiye rakety SSSR (RF) i SShA* (Moscow: RVSN, 1996) p. 148

83 Afanasyev, 'Unknown Spacecraft' pp. 39-40

84 Kamanin, 'A Goal Worth Working for' p. 9

development of the high-thrust RD-270 engines. Glushko had begun work on these in 1962, but by 1966, there had still been no ground firings of the engine. Commission members were also less than happy with the environmental dangers posed by such huge amounts of toxic propellants in the UR-700 rocket. The acoustic problems at liftoff were also unresolved. Finally, the actual return apparatus of the LK-700 had a very small volume. For cosmonauts who would have to wear EVA spacesuits the entire duration of the mission, comfort would have to be sacrificed. Despite Chelomey's protestations to the contrary, the commission members believed that the limited size and performance characteristics of the LK-700 would preclude long-duration landings on the Moon; such missions would have to use high-energy stages. The NI-L3 also had many of the same weaknesses as the UR-700, but at least work on the former had already been ongoing for several years. In the end, the Keldysh Commission declined to recommend serious work on the UR-700 project in November 1966, although it seems that a formal termination decision did not take place until August 1967, invoking the "unreasonability of continuation of further works on the UR-700."⁸⁵ Unfortunately for the Soviet lunar program, this was only a temporary respite. Like a phoenix, the specter of the UR-700 would rise again.

Deadline for the Moon

If, for the time being, the threat from Chelomey and his UR-700 had receded to the background, Mishin's NI-L3 effort had much more imposing problems: these involved funding, delays, and technical obstacles. His engineers had completed the final draft plan for the L3 complex in mid-1966, and it was only after that "with a six year delay the government issued the decision on subcontractors for the program."⁸⁶ Earlier, in April 1966, Mishin met with Soviet leader Brezhnev to inform him of the sequence of missions in the overall Soviet piloted lunar program. It would be a three-stage process involving the use of:

- The 7K-OK Soyuz to master rendezvous and docking in Earth orbit
- The UR-500K-L1 complex to perform a circumlunar mission with two cosmonauts
- The NI-L3 complex to land on the Moon

The NI-L3 complex would consist of three stages:

- Test the NI booster and accomplish an automated lunar-orbital flight
- Test the L3 complex and accomplish piloted lunar-orbital flight with a robotic landing on the surface of the Moon
- Perform a piloted landing on the surface of the Moon

Within the framework of NI missions for robotic lunar-orbital flights, in March 1966, Mishin's engineers emerged with a plan to launch the stripped-down Soyuz spacecraft known as the 7K-L1, which was intended for use in the circumlunar project on the NI booster. In this variant, the spacecraft was known as the 7K-LIS, with the "S" standing for the Russian word for satellite ("sputnik"), indicating that its primary mission was to circle the Moon. Engineers believed that three NI-L1 launches early in the NI launch test series would provide valuable experience in not only proving out problems in the NI, but also mastering operations in lunar orbit—an essential requisite for the ultimate piloted lunar landing.

85. For November 1966, see Khrushchev, Nikita Khrushchev: tom 2, p. 522. For August 1967, see Vetrov interview November 15, 1996. See also Vetrov, "Development of Heavy Launch Vehicles."

86. V. P. Mishin, "The Development of Booster-Launchers in the USSR," presented at the 43rd Congress of the International Astronautical Federation, IAA-92-0197, Washington, DC, August 28–September 5, 1992.

By October 1966, the plan was to start with two to three launches of the automated NI-LI complex. These would lead to three to four launches of the piloted LOK orbiter in lunar orbit, during which an automated LK lander would set down on the Moon, return to the lunar orbit, and link up with the LOK. Finally, it would be on the eighth, ninth, or tenth launch that cosmonauts would accomplish the actual piloted lunar landing.⁸⁷ With strong lobbying from senior engineers within the design bureau, such as Feoktistov, TsKBEM formulated its NI flight plan in such a manner that there was a contingency plan to use a dual-launch Earth-orbit rendezvous mission profile to deliver the landing crew to the L3 complex in Earth orbit. The engineers would resort to this profile only in case there was little confidence in the ability of the NI to safely launch cosmonauts into Earth orbit. All these slight modifications to the basic mission profile put forward by Korolev in late 1964 added layer after layer of complexity to the original vision of a Soviet lunar landing. Instead of simplifying matters, each modification threatened to topple the tenuous balance that barely kept the effort together.

The additions and modifications to the design of the L3 complex through 1967 meant that models designed for flight differed in many ways to the original technical plan on paper which was prepared by engineers in 1965.⁸⁸ For example, the use of three different vehicles on the lunar surface—the LK, the LK_R and the Ye-8 rover—necessitated having constant communications and telemetry from more than one spaceship. Additional communications systems for voice and telemetry, named Foton and Mezon, respectively, were added to the design of the ground stations by late 1967. Mishin also proposed a special ground communications station in Cuba specifically for lunar operations. Remarkably, the Soviets announced the existence of such a station by October 1968.⁸⁹ Power and mass limitations also affected the conceptions of the LK lander: in late 1967, Mishin was proposing the replacement of the lander's chemical batteries with solar panels on the fifth and sixth production models. There were other changes in the Ye-8 rover designed for lunar surface operations. In January 1967, Mishin and Babakin agreed to a tactical-technical requirement for the rover, stipulating that life support would be ensured on the lunar car for a full forty-eight hours. By early April, however, mass constraints deadlocked Babakin's engineers, and a variety of problems arose in the operation of the life support package on the rover. The problem evidently delayed the preparation of a final draft plan for the Ye-8 well beyond the expected time period.

The sequence of launches planned in October 1966 meant that, at conservative levels, the hundreds of contractors and subcontractors would have to sustain a launch rate of about one NI every three months through 1967 and 1968. Any realistic assessment of the situation within the lunar program in late 1966, however, would have given pause even to the most superficial of observers that this pace would be impossible to maintain. Perhaps the most serious source of delays was the main engines for the NI booster. Space program leaders such as Smirnov, Afanasyev, Dementyev, and Pashkov met in March 1966 to discuss problems with the development of the engines. One major source of anxiety was the NK-15V engine for the second stage. While the NK-15s for the first stage had been tested 153 times in static stands, there was still no test stand existing that allowed the NK-15Vs to be tested in altitude conditions. Chief Designer Kuznetsov's OKB-276, the lead developer of the engines, and several plants located at Kuybyshev were lagging in their work on the engines—a problem compounded by

87 According to production figures from October 1968 three to four NIs were to be manufactured in 1967 six in 1968 and six in 1969—a total of fifteen or sixteen. These numbers evidently included three for ground testing only—the articles IM1, IM2 and IM3. The flight versions began with the designations 2L, 3L, 4L, and so on. By December 1966 the preparation of IM1 was delayed from December 1966 to February 1967.

88 The "final" draft plan for the L3 complex was finished in mid 1966 according to Mishin. See Mishin "The Development of Booster Launchers."

89 *Soviet Space Programs 1966-70* p. 150.

a shortage of labor." Pashkov reminded the participants that the engines were to have been delivered for use on flightworthy NIs in January 1965. It was clear that the primary bottleneck in the program was engine development, and it was this fact that determined the huge delays in the NI program at the time.

The estranged Glushko also may have contributed to raised tensions among Kuznetsov's engineers. Astonishingly, as late as 1967, Glushko was still talking openly of revising the NI rocket so as to use his old RD-253 engines, which by then were in use in Chelomey's UR-500K Proton booster. One engineer later recalled that "[It] was a difficult period of time for Kuznetsov: there was one accident after another on the test stands. Glushko followed all this jealously." The final testing of the NK-15 engine occasionally displayed partial burnout of the firewall of the combustion chamber or the nozzle. Engineers at OKB-276 later introduced deliberate burn-throughs in the engines to test engine tolerance, and they were fortunate to discover that the units performed in a stable manner despite the burn-throughs. Before the NK-15 engines were released for series production, on one occasion, one of the experimental units "smoked out" during a test, bolstering Glushko's arguments against Kuznetsov's engines. At a meeting of a joint commission to investigate the accident, Glushko said, "You can see for yourselves that the engine is bad. It's not fit for work, and certainly not for installation on such a crucial piece of hardware like the NI."⁹² Fortunately for Kuznetsov, the commission later ascertained that the fault had been caused by a production defect and not a design flaw: the engines were recommended for series manufacture.

The program to develop high-performance liquid hydrogen engines, so doggedly pursued by Korolev in the last years of his life, was also vigorously supported by his successor Mishin. It took a long time, but seven years after Korolev's first letters to the government requesting funds for liquid hydrogen engines, the Soviets tested such an engine. On April 8, 1967, engineers directed the first ground test of the first Soviet liquid oxygen-liquid hydrogen engine, the RD56, designed and built by the Chemical Machine Building Design Bureau (formerly OKB-2) headed by Chief Designer Isayev." By this time, the Soviets were a full six to seven years behind the United States in this critical area of rocket engine technology. While it was clear that liquid hydrogen would not be an integral part of the first NI version, by September 1967, Mishin had sent proposals to the Ministry of General Machine Building on the use of Isayev's engine on an upper stage designated Blok R for a subsequent version of the NI.

There were delays in the development of the L3 complex. The late start of the Soviets in 1964 was finally beginning to have a significant long-range effect on competing with Apollo. By the end of 1966, neither the Blok I engine (for the LOK orbiter) nor the Blok Y engine (for the LK lander) had been tested on the ground. The most optimistic forecast was that they would be tested in July and August 1967, respectively. The workload on TsKBEM was so severe in 1966 that Mishin and his deputies even considered handing over all development of the LK to Chief Designer Babakin's organization.⁹⁴ Naturally, such uncertainties did little to instill con-

90 Within OKB 276, V. N. Orlov and V. S. Anisimov, two of Kuznetsov's deputies, were appointed to lead the NI engine team. Several subgroups focused on specific areas, including high thrust engines (headed by Deputy Chief Designer N. D. Pechenkin) and NI third- and fourth stage engines (Deputy Chief Designer N. A. Dondukov). Engineers Astakhov and Yelizarov were assigned to lead the development of gas generators and turbopumps, respectively. See Rudenko, "Space Bulletin: Lunar Attraction."

91 M. Rebrov, "But Things Were Like That—Top Secret: The Painful Fortune of the NI Project" (English title), *Krasnaya Zvezda*, January 13, 1990, p. 4.

92 Igor Afanasyev, "NI: Absolutely Secret" (English title), *Krylya rodiny*, no. 11 (November 1993), 4–5. The chair of this commission was Chief Designer A. D. Konopatov of the Chemical Automation Design Bureau (KB KhimAvtomatiki), formerly known as OKB-154.

93 "Calendar of Memorable Dates" (English title), *Novosti kosmonavtiki*, 8 (April 7–20, 1997), 59–60. Semenov, ed., *Raketno-Kosmicheskaya Korporatsiya*, p. 262.

94 V. M. Filin, *Vospominaniya o lunnom korablye* (Moscow: Kultura, 1992), pp. 9–10.

confidence in the engineers who had worked on the vehicle for several years. TsKBEM's finances were also stretched to the limit in 1965 and 1966, which led officials to cut corners on various ground and in-flight systems. The design bureau was beset by a 51 million ruble shortage in 1965 that increased in 1966.

Construction of the launch complexes for the NI was well under way by the time that Mishin took up his duties as chief designer. The original plan was to build two launch complexes, each with two pads. Financial constraints, however, forced engineers to plan for only a single launch complex, designed by GSKB SpetsMash led by Chief Designer Vladimir P. Barmin. It would be the culmination of Barmin's career in the space and missile business. A contemporary of Korolev's. Barmin graduated in 1930 as a mechanical engineer and had the ghoulish honor of creating a special refrigerating device for Lenin's mausoleum. In 1937, Barmin was dragged off to the Lubyanka prison to be questioned about a trip he and some other engineers had made to the United States in 1935 as part of a business delegation. When the group had come under suspicion, the head of the group committed suicide; most of the other members were arrested. Barmin was let go, but he lost his job. He made the leap from refrigerators to missiles in June 1941, when he was put in charge of production at the famous Kompressor Plant, where thousands of Katyusha missile launchers were manufactured during the war. For a brief period, Barmin had the dubious distinction of working for Andrey G. Kostikov, the engineer who had been instrumental in sending Korolev and Glushko to the GULag.

After the war, Barmin and Korolev struck up their acquaintance once again, and the former led the development of launch complexes for almost every single Soviet long-range ballistic missile, including the famous R-7 ICBM. Barmin also had his run-ins with the Soviet leadership. In 1959, when Khrushchev abruptly decided to terminate further work on the Mirnyy missile launch site near Plesetsk. Barmin asked permission to speak at a meeting and told Khrushchev to his face that such a decision would be in error. His persuasive arguments won the day. The Mirnyy site was completed, eventually becoming the most prolific space launch site in the world." Although Barmin's GSKB SpetsMash organization did not retain its monopoly in the design and creation of launch complexes, it inherited a leading role in the field by the strength of its participation in the UR-500K and NI programs. In January 1967, GSKB SpetsMash was renamed the Design Bureau of General Machine Building (KB OM).

Barmin's team began construction of the first launch pad (site 110 right) in September 1964 and completed it in August 1967. The second pad (site 110 left) was built between February 1966 and late 1968. The scale of construction associated with the launch complex, about thirteen kilometers to the northwest of the famous site 1, was huge. A large technical zone and living area was built seven kilometers from the launch pads at site 113 for personnel from the Progress Machine Building Plant who were on assignment from Kuybyshev to oversee the assembly and testing of flight-rated boosters. Technical and materiel supplies were brought to Tyura-Tam on a daily basis via two huge trains, each with several dozen wagons. The railcars were evidently so large that delegations from other socialist countries often came to the launch site to view the trains.⁹⁶

When it was finished in 1968, site 110 consisted of two launch pads located 500 meters from each other, each with 145-meter-tall service towers for propellant loading, power supplies.

95 Col M. Rebrov. "To Do Tomorrow: Pages From the Life of the Chief Designer of Space Launch Complexes" (English title) *Krasnaya zvezda*. October 22, 1988, p. 3, Boris Khlebnikov, "Vladimir Barmin: One of the Top Six Designers." *Aerospace journal* no 2 (March-April 1997) 81-83

96. J. Villain. "A Brief History of Baikonur." presented at the 45th Congress of the International Astronautical Federation IAA-94-IAA.2.1 614, Jerusalem, Israel, October 9-14, 1994; Leonard Nikishin. "Rough Going on Interplanetary Trajectories. How We Exerted Ourselves to the Utmost in the Lunar Race" (English title). *Obshchaya gazeta*. July 15, 1994, p. 9.

crew boarding, and thermal control. After the completion of prelaunch procedures, the tower would be moved away, leaving the NI at the pad, "held down" by forty-eight pneumo-mechanical locks. In addition, four 180-meter-tall lightning rods were built around each launch pad. A total of ninety unique structures were eventually constructed at site 110 for NI operations, dwarfing any other launch complex at Tyura-Tam.⁹⁷ In the early 1960s, engineers had originally proposed assembling the 105-meter-tall launchers vertically in a special assembly building. Because this would have necessitated the construction of a gigantic building 160 meters tall, the engineers decided to lessen the funding strain by opting to assemble the boosters horizontally in a "smaller" building. The latter was the gigantic assembly-testing building for NI assembly at site 112, with the dimensions of forty-seven (height) by 240 by 250 meters. It was reputed to be the largest building on the Eurasian landmass. A second assembly-testing building at nearby site 2B was dedicated for assembling the L3 complex, while the fueling station was located at site 112A. During launch operations, the L3 would undergo preflight checking in its building, covered by cowling, and be transported by rail to the fueling station for propellant loading. From



Chief Designer Vladimir Barmin was one of the original members of the Council of Chief Designers. His organization was responsible for designing and creating launch complexes for a wide spectrum of Soviet missiles and space launch vehicles. In later years, Barmin expanded into other areas, such as designing lunar bases, lunar sample return scoopers, and space-based furnaces (files of Peter Gorin)

there, the L3 stack would be transported to the larger assembly building, where it would be connected to the assembled NI in a horizontal position. After further tests, the NI-L3 booster stack would be transported by two diesel locomotives moving on parallel tracks to the launch pad.⁹⁸

With such an impressive level of construction at Tyura-Tam in the 1960s, it is not surprising that U.S. photo-reconnaissance satellites were able to pick up convincing signs that the Soviet Union was indeed running the race to the Moon. The first public indication that the USSR was engaged in building a massive rocket came in the fall of 1966 when a reporter from *The New York Times*, Evert Clark, quoted "official sources" that the "Soviet Union is believed to have finally begun developing a rocket of 7.5-to-10-million pounds of thrust enough to send men to the Moon. . . ."⁹⁹ A top-secret CIA report from early 1967, declassified twenty-five years later, indicates that U.S. intelligence services were well apprised of concurrent Soviet efforts. Designating site 110 at Tyura-Tam as "Complex J," the authors of the report wrote:

The construction of Complex J at Tyuratam [sic] makes it clear that the Soviets have under development another and much larger booster (than the Proton). Complex J is a very large launch facility which appears to be of the same magnitude as the U.S. Apollo launch facility at Merritt Island. It has been under construction for the past [three-and-

97 I. A. Marinin and S. Kh. Shamsutdinov "Soviet Programs for Piloted Flight to the Moon" (English title) *Zemlya i Vselennaya* no. 5 (September-October 1993) 77-85

98 *Ibid.* Villain *Baikonour* pp. 65-66

99 Evert Clark "Soviet Is Reported Developing a Big New Rocket" *New York Times* September 13, 1966

a-half] years and we estimate it will be ready for initial launch operations in the first half of 1968 at the earliest.¹⁰⁰

As for the actual piloted lunar landing, the CIA was evidently under the impression that the Soviets were not in it to beat Apollo:

Two years ago, we estimated that the Soviet manned lunar landing program was probably not intended to be competitive with the Apollo program as then projected, [that is.] aimed at the 1968-1969 time period. We believe this is still the case . . . we estimate that the earliest the Soviets could attempt a manned lunar landing would be mid-to-late 1969. We believe that the most likely date is sometime in the 1970-1971 time period."

NASA Administrator James E. Webb joined the chorus of believers who were convinced that the Soviets were building a huge rocket—a belief no doubt bolstered by his access to classified reports from the CIA. During testimony to a House Appropriations subcommittee in August 1967, he stated that "the U.S.S.R. is building a larger booster and will shortly, I believe, in calendar year 1968, be flying a booster larger than the Saturn 5."¹⁰² Webb's claims were dismissed by many, because he was unable to provide any supporting evidence. The complete lack of physical evidence would come in handy in later years when the Soviets engaged in one of the most successful deceptions in the history of space exploration.

The Soviets themselves were not being particularly coy at the time. Although they were shy about specifics, the general tone of Soviet public figures did not leave any doubt as to the ultimate goal of the Soviet space program. As one would expect, the cosmonauts were the most vocal in their pronouncements; although the Communist Party maintained strict control over each and every word uttered by these young men, they were more amenable to fits of spontaneity than their elder bosses. On April 12, 1965, during celebrations in honor of Gagarin's flight, cosmonaut Belyayev, fresh from his recent trip on Voskhod-2, spoke in hyperbolic terms about the lunar program: "Preparations are in full swing. The Americans speak broadly about their preparations to land a man on the Moon, but naturally, we in our country, are not idle either. We shall see who will be there first." " Less than a year later, Bykovskiy, praising NASA's lunar-orbit rendezvous mission profile, added that work was in full swing to develop maneuvering ships and suits needed for work on the lunar surface." "A few months later, in April 1966, Leonov spoke candidly in Hungary:

I think that I do not disclose any secret by saying [that] Soviet cosmonauts are *preparing* for such a journey [to the Moon]. I should very much like it if a Soviet man went to the Moon first because we were the first who made the most important steps in space. I believe we shall soon witness man's landing on the Moon. I cannot say when, but it will be during this five-year plan period.¹⁰⁵

In the complete vagueness that surrounded Soviet pronouncements on the space program at the time, cosmonaut Komarov made one of the most specific statements during a visit to Japan in July 1966:

¹⁰⁰ U.S. Central Intelligence Agency. "National Intelligence Estimate 11-1-67: The Soviet Space Program." Washington, DC, March 2, 1967, p. 11, as declassified December 11, 1992, by the CIA Historical Review Program

¹⁰¹ *Ibid.*, p. 2.

¹⁰² Evert Clark, "New Soviet Shot is Expected Soon," *New York Times*, August 19, 1967

¹⁰³ *Soviet Space Programs, 1966-70*, p. 359

¹⁰⁴ *Ibid.*, p. 361.

¹⁰⁵ *Ibid.*, p. 362

There is no need to make haste about a Moon trip by human beings—and the important thing is how to carry out everything in safety. But I can positively state that the Soviet Union will not be beaten by the United States in a race for a human being to go to the Moon.¹⁰⁶

Upon his return to Moscow, cosmonaut overseer Kamanin confronted Komarov about his unauthorized statement. Having deviated too much from the doctrinal line, there were calls from the Central Committee and the Council of Ministers regarding the "incident."¹⁰⁷ Remarkably, it was roughly at the same time that one of the most authoritative aerospace trade journals in the United States, *Aviation Week & Space Technology*, reported that the Soviets were not heading for the Moon. In a long article in November 1966, the author reported that the:

Soviet Union is showing increasing signs of having conceded the manned lunar landing race to the U.S. as part of a vastly revamped space program. The new space philosophy, which the Soviets consider better balanced though less dramatic than their previous one, could produce a much less complex manned circumlunar mission without landing within the next year.¹⁰⁸

It was one of the best examples of how much Western analysts misread the intentions of the Soviet space program at the time, which as it happens was going through a transition, but one that was not clear to observers of that era.

In contrast to the early 1960s, the Soviet space program as a whole was not afforded relatively uncontrolled access to funding. Brezhnev was considerably less sympathetic toward the space program than his predecessor, and salaries in the space industry were said to have gravitated to more average levels during the early years of the post-Khrushchev era. As one senior official at the Central Scientific-Research Institute of Machine Building (TsNII Mash) recalled, Brezhnev "supported space only if brought political dividends."¹⁰⁹ While detailed figures on appropriations for space still remain classified, it is known that the Soviet Union spent 7.9 billion rubles on its space program during the period 1966–1970.¹¹⁰ At the prevailing unofficial conversion rate, this amounted to approximately \$24 billion, or 1.25 percent of the Soviet Union's yearly gross national product during the same period.¹¹¹ The NI-L3 project was about 20 percent of the total space budget each year, amounting to roughly \$4.8 billion of expenditure from 1966 to 1970 (in 1966 U.S. dollars).¹¹² Thus, although the Soviet Union's expenditures on space were close to twice the portion of its gross national product as in the United

106 Evert Clark "Soviet Spaceship Hunting Quarks" *New York Times* July 17 1966 p 55 *Ibid* p 363

107 Kamanin "A Coal Worth Working for"

108 Donald C. Winston "Soviets Revamp Lunar Space Plan" *Aviation Week & Space Technology* November 28 1966 pp 22–23

109 Stephane Chenard "Twilight of the Machine Builders" *Space Markets* 7(5) (1991) 11–19

110 Yu. Koptev "Space Fantasies: Glasnost vs. Rumors" (English title) *Ekonomika i zhizn* 38 (September 1990) 19

111 The conversion rate used was \$3 = 1 ruble extrapolated from figures in *Soviet Space Programs 1966–70* pp 108–09 Table 1 gives the Soviet gross national product for 1967 as \$365 billion (in 1966 U.S. dollars) Table 2 gives the Soviet state budget for 1967 as 115.24 billion rubles. The figure of 1.25 percent has been extrapolated from totaling the Soviet state budget for 1966–70 and then determining the ratio of the space budget (7.9 billion rubles) as a percentage of the cumulative state budget (631.13 billion rubles). Note that the actual figures were remarkably close to those predicted in 1971 without the benefit of any "real" figures. Analysts hypothesized at the time that the Soviet space budget was 1.5 to 2.0 percent of the Soviet gross national product.

112 The ratio of the NI-L3 to the total space budget has been extrapolated from Stephane Chenard "Budget Time in Moscow" *Space Markets* 7(5) (1991) 10

States, actual dollar expenditure on space and the lunar program in particular was far less than that of its primary competitor."¹³

The end of 1966 was a particularly critical decision-making point for the leaders of the Soviet space program. NASA had just completed ten highly successful Gemini missions, displaying a remarkable level of expertise in mastering complex operations in Earth orbit, while the Soviets had not launched a single cosmonaut into space. American successes were bolstered in 1966 by two launches of the Block I Apollo Command and Service Module, as well as a test launch of the S-IVB high-energy cryogenic upper stage.¹⁴ By the end of the year, three astronauts were preparing for the first piloted launch in a Block I Command and Service Module aboard the Saturn IB to conduct a thorough testing of the entire spacecraft in Earth orbit. The giant Saturn V, meanwhile, was scheduled to take an automated Apollo spacecraft into Earth orbit by the summer of 1967. In early January 1967, Boris A. Stroganov, one of Serbin's deputies in the Central Committee's Defense Industries Department, told Mishin that the upper echelons of the Communist Party were extremely concerned about the Soviet lag behind the United States. All this warranted a response, especially given that many of the deadlines from the original August 1964 decree on the Soviet lunar landing had remained unfulfilled as a result of poor management and insufficient funding. There had already been a number of decrees through 1966 on the lunar program at the level of the Ministry of General Machine Building.¹⁵ Speaking of a decree in late 1966, Lt. General Kamanin wrote in his personal journal on November 10:

I read the [Military-Industrial Commission] decree which says that the 1964 decisions of the [Communist Party] and the Council of Ministers on orbiting the Moon and landing humans on the Moon are not being fulfilled properly. The resolution reiterates orders to the industry to give top priority to all work connected with spacecraft and rockets and to treat them as special state assignments. There are sure to be many more such resolutions, rebukes, and reprimands as the temperature over the Moon rises. But papers and reprimands don't get anywhere: too much time has been wasted. The bosses, however, won't hear about our problems and will demand new "spectacular" flights to mark the 50th anniversary of the October Revolution.¹⁶

In October 1966, the so-called "Council for the Problems of Mastering the Moon," which included the leading ministers, deputy ministers, academicians, chief designers, and military officers from the Soviet space establishment, was set up specifically to examine both the macro- and micro-level details of the Soviet program to land a human on the Moon. Headed by Minister of General Machine Building Afanasyev, the council heretofore was the primary advisory body to the Soviet Party and government on all affairs involving the N1-13 project. Rumor had it that Ustinov and Smirnov had set up the council so as to insulate themselves from the possibility of blame if the Soviet lunar program failed. Another possible motive may have been

¹³ Central Scientific Research Institute of Machine Building (TsNIIMash) Director Yu. A. Mozzhorin recalled "The Americans had spent \$15 billion on the creation of an experimental base we had spent only about \$1 billion." See Rebrov, "But Things Were Like That—Top Secret."

¹⁴ The two Command and Service Modules were launched on February 26 and August 25, 1966. The S-IVB test was on July 5, 1966. See Linda Neuman Ezell, NASA Historical Data Book, Volume II: Programs and Projects 1958-1968 (Washington, DC: NASA SP 4012, 1988), p. 187.

¹⁵ There was a Ministry of General Machine Building order (no. 207ss) on May 16, 1966, on the N1. A Military Industrial Commission decree (no. 428) was issued on September 14, 1966, on the N1-L3.

¹⁶ N. Kamanin, "A Coal Worth Working for," p. 8. Kamanin refers to two VPK decrees from this period: one on the "conclusions of the expert commission on [scientific research work] to settle the organization of search and evacuation of lunar ships" and the other on the UR 500K L1 and N1-L3 complexes. See also Kamanin, *Skrytyy kosmos 1964-1966*, p. 388.

to circumvent the power of the Council of Chief Designers with regard to the lunar landing program." The council in its deliberations returned to the original 1964 decree to discuss the issuing of a second decree to stipulate specific schedules for the achievement of a circumlunar and lunar landing mission. TsNIIMash Director Yuriy A. Mozzhorin, an individual who probably had much to do with determining the pace of the space program, recalled:

It was clear to me that the objective was becoming unrealistic and that the volume of the work ahead exceeded the capacities of the sector by a factor of 2-2.5. At a conference of Chief Designers and curators, I expressed doubts. They were met with criticism."

Mozzhorin evidently refused to approve the conditions of the new decree, but it seems that he eventually capitulated under pressure from Afanasyev.¹¹⁹ At the same time, Mishin's principal deputy for the NI. Deputy Chief Designer Okhapkin, pleaded to Ustinov. "We want to solve this problem, we can solve it, and we will solve it on schedule if we receive assistance."¹²⁰

These intensive discussions in late 1966 eventually led to the adoption of another important decree associated with the piloted lunar landing program—one that established goals competitive with the late President Kennedy's set for Apollo. On February 4, 1967, the Central Committee and the Council of Ministers issued a document (no. 115-46) titled "On the Progress of the Work on the Development of the UR-500K-LI."¹²¹ The document, signed just eight days following the Apollo 1 fire, in which three U.S. astronauts were killed during a ground test, called for the consolidation of all national resources in support of the accomplishment of a piloted lunar landing on the Moon prior to the United States. The document was prepared by the four most powerful individuals in the Soviet space program: Ustinov, Serbin, Smirnov, and Afanasyev.¹²²

The authors of the resolution, which still remains classified, described as "unsatisfactory" the work of the government in fulfilling the terms of the original 1964 decree on piloted lunar programs and stated that "a flight around the Moon by a manned spacecraft and the landing of a manned mission on the Moon shall be considered to be objectives of *national importance*."¹²³ Implicitly at least, the resolution freed the purse strings of the Ministry of Defense for the program, but in reality, it seems that the attitude of the primary financiers of the project

117 Kamanin, "A Coal Worth Working for." The composition of the council is still unknown but presumably included all the major chief designers, such as G. N. Babakin (CSMZ Lavochkin), V. P. Barmin (KB OM), V. N. Chelomey (TsKBM), V. P. Clushko (KB Energomash), A. I. Iosifyan (VNII Elektromekhaniki), A. M. Isayev (KB KhimMash), A. D. Konopatov (KB KhimAvtomatiki), N. D. Kuznetsov (KB Trud), V. I. Kuznetsov (NII Prikladnoy mekhaniki), A. M. Lyulka (KB Saturn), V. P. Mishin (TsKBEM), A. S. Mnatsakanyan (NII Tochnykh priborov), N. A. Pilyugin (NII Avtomatiki i priborostroyeniya), M. S. Ryazanskiy (NII Priborostroyeniya), G. I. Severin (KB Zvezda), S. K. Tumanskiy (MMZ Soyuz), G. I. Voronin (KB Nauka), and M. K. Yangel (KB Yuzhnoye). Initially, there were only two military representatives on the council: A. C. Karas (TsUKOS Commander-in-Chief) and A. I. Sokolov (NII-4 Director). Another source states that by December 1967, the council included "Marshal N. I. Krylov, Marshal Rudenko, Ministers of Aviatron, Defense and Radio Industries, all the primary Chief Designers, the President of the Academy of Sciences Keldysh, and the Deputy Chairman of the VPK Pashkov." See Chertok, *Rakety i lyudi: goryachye dni kholodnoy uoyny* pp. 476-77. There was evidently another "Moon Council," this one for automated exploration, whose chair and deputy chair were M. V. Keldysh (AN SSSR) and G. A. Tyulin (MOM), respectively. See Mozzhorin, *Dorogi v kosmos*, I, p. 162.

118. Rebrov, "But Things Were Like That—Top Secret," p. 4. For Mozzhorin's own account on his doubts on the decree, see Rudenko, "Space Bulletin: Lunar Attraction."

119. Rudenko, "Space Bulletin: Lunar Attraction."

120. Rebrov, "But Things Were Like That—Top Secret," p. 4.

121. Mishin, "Why Didn't We Fly to the Moon?"

122. Leonard Nikishin, "Inside The Moon Race," *Moscow News* 7 (April 11, 1990): 15.

123. N. Kamanin, "A Coal Worth Working for" (English title), *Vozdushnyy transport* 46 (1993), 8-9. Author's emphasis.

CHALLENGE TO APOLLO

remained unchanged. Less than two weeks after the document was issued by the leadership, new USSR Minister of Defense Marshal Andrey A. Grechko refused to provide money for a search-and-rescue service for returning cosmonauts from the Moon. When he was told by Air Force leaders that about 25 to 30 million rubles and 9,000 personnel would be required, he lashed back. "I won't give you personnel. I won't give you money. Do what you like but I won't raise this with the government. . . . And in general I am against Moon missions."¹²⁴ This lack of commitment was devastating to the project.

The February 1967 document detailed astonishingly ambitious timetables for both the L1 and the L3 programs:

Mission	Date
First piloted circumlunar flight of the UR-500K-L1	June–July 1967
First flight tests of the NI-L3	September 1967
First piloted lunar landing of the NI-L3	September 1968

In an extreme case, the landing could have been achieved between October and December 1968.¹²⁵ It remains unclear what prompted Ustinov and the others to aim for such an unrealistic schedule. By February 1967, the NI had yet to fly while the L3 complex existed only on paper, and yet the Soviets were proposing that this highly complex mission be accomplished in less than two years. The only visible manifestation of any progress was the completion of the first full-scale NI test vehicle, the IM1, which was finally assembled at Tyura-Tam that same February, although it remained in the giant assembly-testing building. Actual flight models, although being manufactured, were well behind in the queue. Clearly, the senior staff of TsKBEM, including Mishin, were as much responsible for stipulating these outlandish deadlines as was the political leadership. These TsKBEM employees, after all, were the ones who made assessments of the state of the program in late 1966, on whose basis Ustinov and the others made their decisions. To have agreed to the late 1968 deadline seems in retrospect to have been professional suicide, but for reasons that are still not clear, the designer faction accepted them. Kamanin wrote in his journal entry for March 15, 1967: "There is no doubt in my mind that these *deadlines* are anything but realistic."¹²⁶ It was probably clear to most engineers that if past experience was any indicator, the government would be unwilling to back this near ridiculous deadline with any sort of financial commitment.

First Secretary of the Central Committee of the Communist Party Leonid I. Brezhnev and Chairman of the USSR Council of Ministers Aleksey N. Kosygin signed the February 1967 document and officially made it binding to all the hundreds of primary and secondary contractors working on the lunar program. Nearly six years after Kennedy's speech, the Soviet piloted lunar landing program was an objective of national importance. It was the Soviet leadership's belief that if the Soviet military-industrial complex performed as stipulated, a Soviet citizen would be standing on the surface of the Moon by the end of 1968. The fact that the United States' with all its industrial might, had been trying for the same objective for six years could not have escaped the notice of all involved. Speaking of the document that had appeared far too late and of the government that had ignored the pleas of designers for so many years, a Soviet journalist wrote years later:

124. *Ibid.*

125. See Tarasov, "Missions in Dreams and Reality," in which Mishin says that the timetable for the flight tests was to be in the second quarter of 1967 and the landing in the third quarter of 1968.

126. Kamanin, "A Goal Worth Working for," no. 46.

This shows the *level* of competence of the top Soviet leaders Brezhnev and Kosygin who signed the document [and] the honesty of the Party and government officials who prepared this document: Ustinov. Smirnov. Serbin, Afanasyev.¹²⁷

Defining the Circumlunar Program

Through 1966, the LI program to send Soviet cosmonauts around the Moon assumed primacy in importance over the L3 landing effort—a strategic shift motivated very much by the impending fiftieth anniversary of the Great October Revolution in late 1967. The basic elements of the project had been frozen by a document issued on December 31, 1965, titled "Initial Data on the LI Payload Block (Product IIS824)," signed just two weeks before Korolev's death. The main points of this document described the changes necessary to the spacecraft and launch vehicle to accomplish the piloted circumlunar mission.¹²⁸ For the 7K-LI vehicle in particular, there were three goals:

- Create a modification of the 7K-OK Soyuz spacecraft, designated the 7K-LI, capable of circumlunar flight with a crew launched in the vehicle
- Establish a phased realization of the goals:
 - Create the technological-model complex IMI with 7K-LI no. 1P
 - Create automated variants for circumlunar flight on 7K-LI nos. 4–9
- Prepare 7K-LI nos. 11–14 for piloted circumlunar flight"

The 7K-LI spacecraft (also called simply the "LI") was essentially a stripped down 7K-OK Soyuz, reduced to "fit" the 5.1- to 5.2-ton mass constraints for a circumlunar mission using Chelomey's UR-SOOK rocket and Mishin's Blok D upper stage combination. Depending on the particular variant, total mass varied from 5.2 to 5.7 tons (in Earth orbit) and 5.0 to 5.5 tons (after TLI). The primary difference between the Soyuz and the LI was the omission of the spheroid living compartment in the latter, making the LI a compact two-module spacecraft built for a singular objective with little room for upgrades. The two modules were the descent apparatus and the instrument-aggregate compartment.

The descent apparatus was a segmented-conical body with an improved heat shield sufficiently strengthened to withstand lunar return velocity reentries. This shielding would be cast off prior to the actual landing on Earth. The two-person crew would spend their entire eight-to-ten-day mission within the confines of this capsule with an internal volume of only two and a half cubic meters, compared to the Soyuz, which afforded six and a half cubic meters. Apart from the crew couches, the descent apparatus also contained the ship's control panel, an on-board computer, scientific instrumentation, a camera, life support systems, portions of the ther-

¹²⁷ Nikishin 'Inside the Moon Race' p 15

¹²⁸ Semenov ed *Raketno Kosmicheskaya Korporatsiya* p 235 The nine points related to the overall complex were (1) use Blok D from the NI booster as a TLI stage (2) use the 7K OK Soyuz as the spacecraft but without the spheroid living compartment at the forward end the descent apparatus would be modified for lunar speed atmospheric reentry and a special supporting cone at the apex of the now shortened vehicle would allow connections with the launch escape tower (3) eliminate mooring and orientation engines from the 7K OK Soyuz and transfer these functions to the SOZ system on Blok D (4) develop a new payload shroud (5) ensure that Blok D can refire in vacuum conditions (6) ensure that Blok D can fire to allow TLI (7) agree on a cycle of events for the UR 500K Proton booster during launch allowing launch escape and rocket safety (8) develop the details of a circumlunar trajectory with return at lunar velocities and (9) create simplified 7K LI spacecraft numbers 2P and 3P for tests in Earth orbit which would include two firings of Blok D

¹²⁹ *Ibid* p 236

mal regulation and communications systems, biological samples, an optical orientation device, and a storage battery. One of the improvements on the capsule compared to the Soyuz was doubling the number of thrusters for yaw during guided reentry. This augmentation in reentry capability was offset to a great degree by the omission of the reserve parachute from the descent apparatus because of both space and mass constraints. The single remaining parachute had a dome area of 1,000 square meters. The deletion of the living compartment prompted engineers to attach a special support

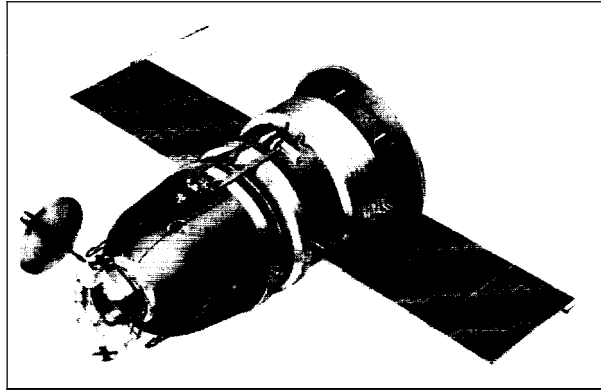

The 7K-L1 spacecraft was the final iteration of Korolev's repeated attempts to design a flight-capable piloted circumlunar ship. The vehicle, later publicly named Zond, was similar in terms of most systems to the Earth-orbital Soyuz. The major design difference between the two was the omission of the forward living compartment on the Zond spacecraft. Two cosmonauts would have to spend a cramped week within the confines of the tiny descent apparatus. (copyright VideoCosmos Co., via Dennis Newkirk)

cone to the apex of the spacecraft to allow a firm connection with the nose fairing and the launch escape tower of the booster stack. The cone, weighing 150 kilograms, would be cast off from the vehicle prior to TLI. As with the Soyuz and the NI-L3, the launch escape system was equipped with a set of powerful solid-propellant engines to remove the descent apparatus far from an exploding rocket.

As in the 7K-OK Soyuz, the 7K-L1 instrument-aggregate compartment was divided into three sections: the transfer compartment, the instrument compartment, and the aggregate compartment. The pressurized instrument compartment contained the primary and backup buffer storage batteries and additional ship instrumentation for on-board systems. The unpressurized aggregate compartment at the extreme aft of the ship contained the single high-thrust engine on the spacecraft, the S5.53, developed by the Design Bureau of Chemical Machine Building, led by Chief Designer Isayev. The engine used unsymmetrical dimethyl hydrazine and a mixture of nitric acid and nitrogen tetroxide (AK-27) and had a thrust of 425 kilograms—that is, it was identical to its counterpart on the Soyuz spacecraft. The 400 kilograms of propellant for the engine was contained in four spherical tanks at the aft of the aggregate compartment, which also included eight attitude control thrusters operating on hydrogen peroxide (of one and one and a half kilograms thrust). Thermal radiators covered the whole compartment on its outer surface. As with the Soyuz, primary power on the vehicle was provided by two large solar arrays, spread like bird wings from the aggregate compartment. Unlike the Soyuz's four segments on each panel, the 7K-L1 had three per panel, with a wingspan of nine meters and a total surface area of eleven square meters.

Apart from the deletions, TsKBEM engineers supplemented or changed a number of systems from the basic 7K-OK Soyuz craft. These included the attitude orientation system, which had improved solar (the 99K) and stellar sensors (the IOOK), gyroscopes and command instruments, memory devices, and so on. For transmitting telemetric information, the engineers introduced a pencil-beam parabolic antenna operating in the decimeter range, which was attached at the front of the descent apparatus. The antenna had its own self-contained optical sensor for aiming at Earth (the IOIK). The antenna as a whole would be discarded once its work was finished. Other antennas included short-range ones at the end of the solar panels (for radio communications) and additional ones for ultra-shortwave telemetry and radiotelemetry.

The guidance system for the 7K-L1 spacecraft was developed cooperatively by the organizations of Mishin and Pilyugin based on earlier models used for deep space probes as well as control engines for earlier ships and rocket stages. For the first time in a Soviet piloted spacecraft, the guidance systems operated on the basis of a three-axis stabilized platform and a special computer named the *Argon-11*, developed by Scientific-Research Institute of Digital Electronic Computing Technology. It would serve as the prototype for all further models in the Soyuz spacecraft.

The 7K-L1 spacecraft had a total length of five meters with the support cone and four and a half meters without. Maximum diameter was 2.72 meters at the base and 2.2 meters around the main body. The total length on the pad of the UR-500K, Blok D, 7K-L1, and launch escape tower combination was just over sixty-one meters, far exceeding the length of Soyuz spacecraft stack.¹³⁰

A nominal mission profile of the circumlunar mission would begin with the launch of the UR-500K Proton booster with its 7K-L1 and Blok D payloads. During the launch, the ship would be beneath a fairing, which would be cast off after passing through the dense layers of the atmosphere. The partially filled Blok D would fire for the first time to achieve sufficient velocity to lift itself and the 7K-L1 into an Earth orbit with the parameters of 220 by 190 kilometers inclined at fifty-one and a half degrees. The cosmonauts aboard would check the state of all systems for a period of one orbit or one day, depending on the circumstances, orient the stack for boost toward the Moon, and then separate the support cone from the apex of the spacecraft. Blok D would fire for a sufficient period of time to accelerate the stack to Earth escape velocity toward the Moon. The stage would then separate while the ship's solar orientation system would put the spacecraft in a one-degree-per-second turning mode while ensuring maximal solar panel exposure to the Sun. The 7K-L1 ship would circle around the Moon at a range of 1,000 to 12,000 kilometers while the cosmonauts would carry out photography and TV sessions. The scientific investigations planned for the automated precursor missions would include studying radiation through the flight path, studying cosmic rays, and performing experiments on small biological payloads. During the course of the seven days in flight, the S5.53 main engine of the ship would carry out three or four mid-course corrections: the first on the outbound trajectory at 250,000 kilometers from Earth and the second and third ones on the return trajectory at 320,000 and 150,000 kilometers, respectively, from Earth.

Before reentry back into Earth's atmosphere, the parabolic antenna and instrument-aggregate compartment would separate from the descent apparatus with its two-person crew. The precision-guided reentry had two endo-atmospheric phases and an intermediate exo-atmospheric portion to radically decrease the gravitational loads subjected to the crew. The first "dip" into the atmosphere would decelerate the vehicle to about just over seven and a half kilometers per second, after which the capsule would "bounce" out of the atmosphere along a ballistic trajectory and reenter the atmosphere again at a reduced velocity of 200 meters per second. A special guidance system would control the motion of the descent apparatus throughout this entire portion by changing the lift force via roll control of the capsule. The length of return trajectory would vary between 6,000 and 10,500 kilometers, depending on the angle between the horizontal plane and the ship at the moment of entry; this was also an important determinant of radio visibility with ground communications stations. After the double-dip reentry, the capsule would come down by parachute, discard its thermal shielding, and finally land in Kazakhstan by using soft-landing engines much like the Soyuz spacecraft. If for some reason the guided reentry

¹³⁰ *Ibid* pp 235-36 Afanasyev "Unknown Spacecraft" I A Marinin and S Kh Shamsutdinov "Soviet Programs for Lunar Flights" (English title) *Zemlya i vseennaya* no 4 (July-August 1993) 62-69 Lardier *L'Astronautique Soviétique* p 159 Glushko *Kosmonautika* entsiklopediya pp 129-30 The two batteries for the 7K-L1 were a silver zinc battery and calcium nickel battery (blok 800)

procedure failed, the descent apparatus would be able to accomplish a simple ballistic reentry into the atmosphere with a subsequent landing in the Indian Ocean."¹³¹

There was one additional cautionary element of the LI circumlunar project, introduced to compensate for any potential troubles with the UR-500K Proton launch vehicle. From early discussions in the fall of 1965, Korolev's engineers had expressed reservations of launching cosmonauts on the still-untested Proton booster—concerns motivated primarily by the use of toxic storable propellants in the rocket. As insurance against the possibility of designers not being able to declare the Proton safe enough to launch humans, Mishin came up with a plan to launch the 7K-LI on the Proton in an automated mode. The crew would be launched separately on a special variant of the Soyuz, which would dock with the 7K-LI ship. The two cosmonauts wearing their Yastreb ("Hawk") EVA suits would exit the Soyuz and transfer into the 7K-LI via "a curved tunnel in the . . . support cone."¹³² The Soyuz would then automatically undock, while the cosmonauts in the LI would carry out their circumlunar mission after a corresponding boost from the Blok D stage. For this plan to work, TsKBEM had to accommodate the manufacture of two special modifications of the 7K-OK and 7K-LI vehicles. The 7K-OK's modification, designated 7K-OK-T, was equipped with a forward unit equipped for docking with a 7K-LI. The 7K-LI's modification not only had the "curved tunnel" but also a custom-built passive docking unit installed at the forward end of the spacecraft at the support cone. This heavy unit would be discarded once the transfer took place and before TLI.¹³³

The Military-Industrial Commission, on April 27, 1966, adopted a decree (no. 101), titled "On Approving the Work Plan to Build the 7K-LI Piloted Spacecraft," which addressed the entire spectrum of issues associated with the LI circumlunar program. The commission approved the manufacture of fourteen such spacecraft: five in 1966 and nine in 1967. Ground testing was to finish and flight testing begin by the last quarter of 1966 or the first quarter of 1967. Among other things, the decree specified schedules for the development, manufacture, and delivery of LI simulators and the establishment of a search-and-rescue service for a spaceship returning from the Moon.¹³⁴ According to the commission's decree, a specific schedule of operations was established for the program:

- September 1966—ground testing of one ship (7K-LI no. 1P) at Tyura-Tam
- October 1966—two automated Earth-orbital tests (using 7K-LI nos. 2P and 3P)
- November–December 1966—two automated circumlunar flights (using 7K-LI nos. 4 and 5)
- December 1966–May 1967—five piloted circumlunar flight with crew transferred to the 7K-LI in Earth orbit after being launched on the 7K-OK-T Soyuz (using 7K-LI nos. 6 through 10)
- June–September 1967—four piloted circumlunar flight with crews launched in the 7K-LI (using 7K-LI nos. 11 through 14)

Such a schedule would ensure the fulfillment of the primary objective of a piloted circumlunar mission prior to the fiftieth anniversary of the Great October Revolution in November 1967.

¹³¹ Semenov, ed. *Raketno-Kosmicheskaya Korporatsiya*, pp. 238–39; Marinin and Shamsutdinov. "Soviet Programs for Lunar Flights", Petrovich, ed. *The Soviet Encyclopaedia of Space Flight*, pp. 513–14

¹³² Marinin and Shamsutdinov. "Soviet Programs for Lunar Flights "

¹³³ The details of the "curved tunnel" and the special docking unit on the 7K-LI in this variant remain unknown.

¹³⁴ N. P. Kamanin, "A Coal Worth Working for." *Vozdushnyi transport* no. 44 (1993): 8–9; Semenov, ed. *Raketno-Kosmicheskaya Korporatsiya*, p. 237. Note that one of the stipulations of the decree was the official termination of Chelomey's UR-500K-LK-1 program in the "full-scale modeling stage. The remaining stages, which envisioned the complete ground-based optimization of all the systems of the carrier and the vehicle, as well as the performance of 12 unmanned and 10 manned launches of the UR-500K-LK complex, were canceled by the same decree." See Igor Afanasyev. "Without the Stamp 'Secret'. Circling the Moon. Chelomey's Project" (English title). *Krasnaya zvezda*, October 28, 1995

As with most other timetables of the Soviet space effort of the period, there were delays. Many within TskBEM believed the entire program to be a useless diversion from the main L3 landing project. Although the L1 project had moved into first priority over the L3, there were continuous postponements in issuing the technical documentation on the spacecraft, as well as testing delays in the construction of and upgrades to the two Proton launch complexes at Tyura-Tam. Being a matter of state importance, the status of the project was constantly examined at the ministry level throughout 1966. The concurrent work on the mainstream Soyuz effort was clearly a major drain on facilities and resources. If TskBEM believed before that carrying out three full-scale piloted projects (Soyuz, L1, and N1-L3) was a manageable prospect, the employees were finding out that they were stretched to the limit. By December 1966, a single 7K-L1 spaceship had yet to get off the ground.

On December 9, 1966, at a meeting of the Council of Chief Designers, Mishin presented a new schedule of flights for the L1 program. Automated test flights of the first phase would include only four missions. Of these, the first two (2P and 3P) would be in Earth orbit to test out Blok D firings, while the remaining two (4L and 5L) would fly full-scale circumlunar missions and return to Earth. After these flights finished in March-May 1967, the first crew would fly to the Moon on June 25, 1967 aboard 6L. Kamanin noted about the meeting: "All the designers expressed doubts that the work could be accomplished within such a short timeframe. Mishin explained to them that he did not invent the schedule, but that it had been dictated to him by Ustinov and Smirnov." An ad hoc twenty-member State Commission to guide the entire test program was established in mid-December with First Deputy Minister of General Machine Building Tyulin as its chair. Among its members were Mishin, Chelomey, and Keldysh.¹³⁶

The State Commission for L1 met for the first time on December 24, when Mishin, Chelomey, and Barmin presented reports on the readiness of the spacecraft, the launch vehicle, and the launch pads, respectively. It was evidently the first time that all the heads of the various branches involved in the project discussed the project together. In accordance with the recommendation of the Council of Chief Designers, the new target date for the first piloted circumlunar mission was set for July 26, 1967. This would be preceded by the four automated flights. During the meeting, Mishin also presented his conception of the "fall-back" docking-in-Earth-orbit scenario to launch the crew not on the Proton booster, but rather in a 7K-OK-T Soyuz spacecraft. After the first few outbound piloted missions, once engineers had gained a modicum of faith in the Proton booster, the cosmonauts would fly directly into orbit on the Proton."

During a second meeting of the commission on December 30, Mishin, Chelomey, and Barmin reported that all systems were on track for the first L1 launch at the end of January. All the members of the commission were due to arrive at Tyura-Tam on January 10-12, 1967. There was some discussion on the establishment of search-and-rescue services for vehicles returning from the Moon. Because, for the first time, the landing of a Soviet piloted spacecraft could be in the oceans, Marshal Matvey V. Zakharov, the Ministry of Defense General Staff Chief, had issued an order on December 21 that assigned the Air Force the responsibility for all land recov-

¹³⁵ Kamanin 'A Goal Worth Working for' no. 45

¹³⁶ The members of the State Commission for L1 included G. A. Tyulin (MOM), V. P. Mishin (TskBEM), V. N. Chelomey (TskBM), M. V. Keldysh (AN SSSR), V. A. Anfilatov (affiliation unknown), N. N. Gurovskiy (IMBP), N. P. Kamanin (WS), A. G. Karas (TsUKOS), V. A. Kasatanov (affiliation unknown), V. A. Khazanov (affiliation unknown), A. A. Kurushin (NIIP 5), G. P. Melnikov (NII 4), N. K. Mordasov (affiliation unknown), Yu. A. Mozzhorin (TsNIIMash), A. G. Mrykin (MOM), D. A. Polukhin (TskBM Branch No. 1), Ye. V. Shabarov (TskBEM), I. I. Spitsa (TsKIK), Ya. I. Tregub (TskBEM), and Yu. N. Trufanov (TskBM Branch No. 1). See Sernenov ed. *Raketno Kosmicheskaya Korporatsiya*, p. 238.

¹³⁷ Kamanin 'A Goal Worth Working for' no. 45

ery operations and the Navy the responsibility for all sea recovery operations. In addition, tracking stations at Feodosiya and Ussuriysk were being modified to communicate with returning spacecraft from the Moon.

The final point of discussion at the meeting was the selection of crews for the project. Cosmonauts had been unofficially grouped together to train for the LI mission by early September 1966. By early December, the main players had agreed on a list of fourteen men from the larger team at the Cosmonaut Training Center to train specifically for this project.¹³⁸ Because of the increasing requirements for cosmonauts in the mainstream 7K-OK Soyuz program, whose launches had already begun by this time, Kamanin and Mishin agreed to train cosmonauts by late December for the LI independently of Soyuz. Cosmonauts who would fly Soyuz missions would be added sequentially to the circumlunar program. The LI group was to undergo a five-month-long training program beginning on January 1, 1967. Each crew would include a commander who had experience from a previous space mission. By January 1967, eleven lucky men had been selected to train for the project, including Leonov, the spacewalker from Voskhod 2, and Popovich, the ebullient pilot from Vostok 4, both favorites for the first outbound flight.¹³⁹ The training for these men was impeded to a great degree by the absence of LI simulators, which, despite much discussion, the M. M. Flight-Cromov Flight-Research Institute had not delivered by the end of 1966 to the Cosmonaut Training Center. The cosmonauts instead trained in 7K-OK Soyuz simulators equipped with new control instruments.

The LI Takes Flight

The first 7K-LI spacecraft was a model built specifically for ground testing at Tyura-Tam. These tests were completed successfully in conjunction with a UR-500K-Blok D combination in January.¹⁴⁰ The success did little to instill confidence that the planners would be able to maintain the compressed schedule handed down by Ustinov and Smirnov. The State Commission met twice on January 17, 1967, and heard reports from a number of chief designers involved in the program. There were "new difficulties" in the preparation of the first Earth-orbital mission, bringing Mishin and TsKBEM under fire from members of the commission. Some designers received reprimands; the commission decided to report the most glaring lags in work to the Central Committee. Chief Designers Grigoriy I. Voronin (of KB Nauka) and Gay I. Severin (of KB Zvezda), responsible for life support, emerged with an unlikely proposal to limit the number of cosmonauts in the 7K-LI crew to one, because of difficulties with the life support system. A final decision on the issue was delayed.¹⁴¹

At a meeting of the State Commission on February 14, the first test flight of the 7K-LI, originally scheduled for January 1967, was put back to late February or early March. The first two flights would primarily test the Blok D TLI stage with two firings: one to achieve Earth orbit and the second to boost the payload to escape velocity. No recovery was planned on either flight. Incredibly, the commission still hoped to carry out four automated missions prior to a piloted one set for June 26, 1967, despite the fact that within the same period, Mishin and the

¹³⁸ *Ibid* The cosmonauts for the 7K-LI program were G. T. Beregovoy, V. F. Bykovskiy, Yu. A. Gagarin, Ye. V. Khrunov, A. A. Leonov, V. M. Komarov, A. G. Nikolayev, V. A. Shatalov, and B. V. Volynov as crew commanders and G. M. Crechko, V. N. Kubasov, O. C. Makarov, V. N. Volkov, and A. S. Yeliseyev as flight engineers.

¹³⁹ Kamanin. "A Coal Worth Working for." no. 46. The new 7K-LI training group had been agreed on as early as December 24, 1966. They were P. I. Klimuk, A. A. Leonov, P. R. Popovich, V. A. Voloshin, and B. V. Volynov (all commanders) and Yu. P. Artyukhin, C. M. Crechko, O. C. Makarov, N. N. Rukavishnikov, V. I. Sevastyanov, and A. F. Voronov (all flight engineers).

¹⁴⁰ Afanasyev. "Unknown Spacecraft"

¹⁴¹ Kamanin. "A Coal Worth Working for." no. 46

other chief designers were to carry out the first highly complex Soyuz mission of docking two such ships in Earth orbit with the subsequent transfer of cosmonauts. Through it all, Mishin, Chertok, and others tried to compensate for the poor management conditions by personally appealing to subcontractors to deliver parts on time. Unbelievably at this late stage, some contractors, such as Chief Designer Ryazanskiy, were not only behind schedule, but did not even know that they had been assigned to make a parts delivery in the first place." Without a singular overseeing entity such as NASA, there was no coordinated plan for maintaining deadlines for dozens of subcontractors.

Some of the pressure on the Soviets to accelerate their lunar program was alleviated by a tragic accident half a world away. By early 1967, NASA was preparing for the first flight of the Apollo Command and Service Module, the spacecraft intended to take the first astronauts to the Moon. The first mission, Apollo 1, was planned to thoroughly test all the essential systems aboard the Block I class of modules. The fourteen-day mission, set tentatively for launch on February 21, 1967, was to be crewed by astronauts Lt. Colonel Virgil I. Grissom, Lt. Colonel Edward H. White II, and Lt. Commander Roger B. Chaffee. Both Grissom and White had flown previous space missions. In preparation for the launch, the crewmembers were simulating a countdown on January 27, when arcs from electrical wiring in an equipment bay in the Command Module began a fire. In the 100-percent oxygen atmosphere of the capsule, the crew succumbed to burns and asphyxia within minutes of the beginning of the fire.¹⁴³

NASA immediately canceled all further missions in the Apollo program and established several teams to determine the causes of the accident. Outside analysts predicted that this would set back the Apollo program by at least a year, if not more. The accident inadvertently gave the Soviet Union an added probability to catch up with the United States following inactivity lasting almost two years. Despite the tragic nature of circumstances, the disaster no doubt instilled a glimmer of hope among the Soviets that perhaps the "race to the Moon" was still a race that had no clear winner. It would not have been surprising if Mishin, Chelomey, Keldysh, and others believed for this brief window that it was a foregone conclusion that the first human to fly around the Moon would be a Soviet citizen.

The first 7K-L1 spacecraft, vehicle no. 2P, was launched from Tyura-Tam at 1430 hours, 33 seconds Moscow Time on March 10, 1967, into a 190- by 310-kilometer Earth orbit inclined at fifty-one and a half degrees to the equator. It was the very first launch of the graceful silver four-stage Proton booster. The spacecraft was named *Kosmos-146* upon entering orbit, no doubt to hide the true mission of the vehicle. The Blok D stage, also in its first mission, performed flawlessly, firing both times—the second time boosting the 5,017-kilogram 7K-L1 vehicle to escape velocity. All except two on-board systems on the spacecraft operated without fault. The RDM-3 radio beacon did not turn off at the computed time because of a circuit error, and the unit worked continuously for forty-two hours instead of the nominal forty minutes. The second minor problem was a fault in the thermo-regulation system that led to an unexpected fall in pressure in one of the main lines.¹⁴⁴ *Kosmos-146* remained in orbit for about nine days, while ground controllers maintained contact for at least five days.¹⁴⁵ The spacecraft probably reached lunar distance apogee before returning back to the vicinity of Earth and burning up on reentry.

The success of *Kosmos-146* was no doubt a tremendous boost for engineers who had labored over the program for more than a year. The second spaceworthy 7K-L1 vehicle, space-

¹⁴² *ibid*

¹⁴³ Ezell NASA *Historical Data Book Volume II* p 176

¹⁴⁴ Semenov ed *Raketno-Kosmicheskaya Korporatsiya* pp 240-41 The actual type of the 7K-L1 spacecraft was 7K-L1P with the 'p' indicating a simplified version not equipped for recovery

¹⁴⁵ Westerners tracked transmissions from the payload during March 11-15 at 20 008 megahertz See Sven Crahn and Dieter Oslander "Cosmos 146 and 154." *Spaceflight* 22 (March 1980) 121-23

craft no. 3P, was quickly prepared for launch within less than thirty days. The vehicle would repeat the exact same profile as its predecessor, except Blok D's second firing would follow one day after entering Earth orbit instead of after one orbit. On April 6, Chelomey, Glushko, Barmin, and other chief designers arrived at Tyura-Tam to view the launch, along with ten cosmonauts who were training for the circumlunar flights. The latter group, including Leonov and Popovich, would study the equipment at the launch pad and get acquainted with all prelaunch operations involving the Proton booster. It was the first time that they physically saw the launch vehicle.

On April 8, the designers and guests watched the launch from site 92, the location of the assembly-testing building for the Proton, a distance of just over one and a half kilometers from the pad at site 81. Lt. General Kamanin described the scene:

Unlike the [R-7.] the UR-SOOK rocket has a simple and well-designed service frame: the base of the frame is to one side of the rocket, but it "hugs it" with five service landings and has two elevators. After the frame is opened the rocket stands there like a beautiful white church. . . .¹⁴⁶

At exactly 1200 hours, 33 seconds Moscow Time, the booster gracefully lifted off from its pad. Despite gusts as high as eighteen meters per second, the performance of all four stages, including the first firing of Blok D, was nominal. The 5,020-kilogram 7K-L1 ship entered a 186- by 232-kilometer orbit with a fifty-one-and-a-half-degree inclination to the equator. TASS announced the mission under the designation of *Kosmos-154*. About forty minutes following launch, all the members of the State Commission gathered at the office of Colonel Kirillov, the newly appointed Deputy Commander of Cosmodrome, to congratulate Chelomey on the success. Throughout the day, ground controllers monitored all systems aboard the Blok D-L1 stack in Earth orbit, conscious of the fact that this would be the first time in the Soviet space program when an upper stage would fire after a stay of twenty-four hours in weightlessness and vacuum.

The news turned sour on April 9, when telemetry proved that Blok D had failed to fire for the second time. After an analysis of incoming data, TsKBEM engineers believed that an instrument switch had been left in the wrong position because of negligence on their part. The instrument was used for triggering a system of engines that stabilize the propellant after the first firing of the Blok D main engine. The engines of this system were apparently prematurely jettisoned, disabling the main engine completely because it was unable to effectively use the propellants.⁴⁷ The blame for the error fell on Mishin's shoulders, and State Commission Chairman Tyulin gave him a dressing down. Kamanin recalled:

Tyulin was furious and swore at him. In the evening, still fuming after the unpleasant experience of reporting to Ustinov and Smirnov, he gave a devastating but perfectly accurate assessment of Mishin: "He has five times more arrogance than Korolev and ten times less competence."¹⁴⁸

The *Kosmos-154* stack remained in its low-Earth orbit for about two days following launch before decaying naturally. The failure undoubtedly slowed the pace of the circumlunar program.

146 Kamanin "A Goal Worth Working for" no 46

147 *Ibid* Afanasyev "Unknown Spacecraft" Semenov ed Raketno Kosmicheskaya Korporatsiya p 241

148 Kamanin "A Goal Worth Working for" no 46 p 9

and the prospect of carrying out the first piloted mission in June or July must have seemed shaky by any stretch of the imagination, especially given the intensive work concurrent in the Earth-orbital Soyuz program. At the same time, even if the June–July deadline seemed out of reach, there was still much hope that two Soviet men would circle the Moon by the November 1967 deadline. But this still vibrant hope was dealt a fatal blow just sixteen days after the launch of Kosmos-154. It would be one of the most devastating incidents in the history of the Soviet piloted space program—an event that crippled its run in the race for the Moon.

CHAPTER THIRTEEN

TRAGEDY

The Soyuz spacecraft was the centerpiece of the post-Korolev space program. Since Korolev's death in January 1966, the design, development, and testing of the 7K-OK Earth-orbital Soyuz were expected to lead to the most spectacular mission in the Soviet canon to date: the docking of two Soyuz spacecraft in Earth orbit, followed by the transfer of two crewmembers from one vehicle to the other via a spacewalk. Soviet space program leaders strongly believed that this one mission would overshadow the cumulative achievements of all ten of NASA's Gemini flights during 1965–66. Thousands of engineers worked toward this singular goal to reestablish Soviet preeminence in piloted space exploration. From a political, technical, and human perspective, the failure to do so was not an option. But as haste crept into the preparations, an atmosphere of unease began to pervade the program.

Civilians in Space

For many years before his death, Sergey P. Korolev had spoken of sending not only military officers into space, but also the young civilian engineers who actually designed and developed Soviet spacecraft, such as Vostok, Voskhod, and Soyuz. Intermittently throughout the early 1960s, several engineers at OKB-1 had passed through preliminary medical screening, but their candidacy as cosmonauts was never taken seriously by the Soviet Air Force, the service responsible for all cosmonaut training.¹ The impetus to include engineers on spacecraft increased significantly with the development of the 7K-OK Soyuz spacecraft, which afforded two to three extra seats for missions. In September 1965, eight military cosmonauts began training for the docking and EVA Soyuz mission, prompting Korolev to entrust one of his engineers to look into the matter of forming a parallel civilian training group.² At least eleven civilians from the design bureau passed the initial medical screening at the Ministry of Health's Institute of Biomedical Problems, but Korolev's death put the matter temporarily on the backburner.³

¹ In September 1961 the Air Force allowed Korolev to send civilian engineers through medical screening. See Rex Hall, 'Soviet Civilian Cosmonauts' in Michael Cassutt, ed., *Who's Who in Space: The International Space Year Edition* (New York: Macmillan, 1992), p. 278.

² The eight military cosmonauts who began training in early September 1965 for the first Soyuz mission were V. F. Bykovskiy, Yu. A. Gagarin, V. V. Gorbatko, Ye. V. Khrunov, P. I. Kolodin, V. M. Kornarov, A. G. Nikolayev, and A. F. Voronov. See N. P. Kamanin, *Skrityy kosmos: kniga vtoraya 1964–1966gg* (Moscow: Infortekst IF, 1997), pp. 347–349. N. Kamanin, 'A Coal Worth Working for' (English title), *Vozdushniy transport* 44 (1993): 8–9. These eight men were still in training for the first Soyuz mission by late August 1966.

³ These eleven men were S. N. Anokhin, V. Ye. Bugrov, G. A. Dolgoplov, G. M. Grechko, V. N. Kubasov, O. G. Makarov, N. N. Rukavishnikov, V. A. Timchenko, V. A. Yazdovskiy, and A. S. Yeliseyev. See I. Marinin, 'The First Civilian Cosmonauts' (in Russian), *Novosti kosmonavtiki* 12/13 (June 30, 1996): 81–87.

With unexpected vengeance new Chief Designer Mishin took up the gauntlet of training civilians, in part motivated by his hostility toward the Air Force, which coveted its total monopoly over cosmonaut training. A governmental decree six years previously had codified that all Soviet cosmonauts, regardless of their affiliations, should be trained exclusively at the Air Force's Cosmonaut Training Center.⁴ But without the agreement of either the Ministry of General Machine Building or the Ministry of Defense, Mishin signed an official order (no. 43) on May 23, 1966, establishing the 731st Flight-Methods Department, which consisted of the first civilian "cosmonauts group" in the Soviet Union. The group members were:

- Sergey N. Anokhin (fifty-six years old)
- Vladimir N. Bugrov (thirty-three)
- Gennadiy A. Dolgoplov (thirty)
- Georgiy M. Grechko (thirty-four)
- Valeriy N. Kubasov (thirty-one)
- Oleg G. Makarov (thirty-three)
- Vladislav N. Volkov (thirty)
- Aleksey S. Yeliseyev (thirty-one)

Anokhin was an odd selection for the group because he was more than twenty years older than the rest. A famous World War II pilot, he had gone on to be one of the most accomplished test pilots in the Soviet Union, flying out of the famous M. M. Gromov Flight-Research Institute outside of Moscow. Acquainted with Korolev since the wartime days, Anokhin had been invited to head up a flight testing department at OKB-1 in April 1964, ostensibly to oversee the training of future cosmonauts from the design bureau.⁵ Given his age (he was six years older than Mishin), his inclusion in the group seems to have been more of a personal favor to Korolev's memory than to any serious plan to launch him into space.

Without official recognition from the Air Force, the eight candidates had little hope of actually flying in space and were known only as "cosmonaut-testers." Mishin, however, tried everything in his power to bypass official Air Force rules. On June 15, 1966, he forced through a formal Military-Industrial Commission decree (no. 144) that stipulated that his eight civilian cosmonaut-testers be considered as candidates for the forthcoming Soyuz flight.⁶ By this time, the friction between the Air Force, represented by the ubiquitous Lt. General Nikolay P. Kamanin, and TsKBEM began to affect the course of the Soyuz program. Without any agreement on the crew, the engineers faced great difficulties in establishing timetables for the highly complex joint mission. In late June, Mishin even went so far as to propose completely civilian crews for the mission, although the eight military officers were finishing up several months of training.⁷

Throughout the month of July, the arguments went back and forth, with both Mishin and Kamanin refusing to budge on their positions. Although First Deputy Minister of General Machine Building Tyulin served as a mediator, Mishin convinced him and other officials,

4 This decree was issued on August 3, 1960 See rbrd

5 Ibrd Yu P Semenov ed Raketno Kosmrcheskaya Korporatsiya "Energiya" rnenr 5 P Koroleva (Korolev RKK Energiya named after S P Korolev 1996) p 426

6 Semenov ed Raketno Kosmicheskaya Korporatsiya p 425 Hall "Soviet Civilian Cosmonauts" p 287

7 Kamanin "A Coal Worth Workng for" no 44; Marinin "The First Civilian Cosmonauts" Semenov ed Raketno Kosmrcheskaya Korporatsiya p 426

8 The civilian crews proposed by Mishin were Dolgoplov/Yeliseyev/Volkov (primary) and Anokhin/Makarov/Grechko (backup) See Marinin "The First Civilian Cosmonauts" In early July there was a new civilian crew proposal Dolgoplov/Makarov (Soyuz 1) and Yeliseyev/Kubasov (Soyuz 2) See Kamanin *Skrityy kosmos* 1964-1966 p 348

including Academy of Sciences President Keldysh and Deputy Minister of Health Avetik I. Burnazyan, to approve a program on July 30 to train a group of civilian cosmonauts for the L1 circumlunar program. The implication was clear: Mishin would no longer use the Air Force's Cosmonaut Training Center. Kamanin, predictably, called the document "a piece of nonsense."⁹ The acrimony came to a head in early August, when First Deputy Commander-in-Chief of the Air Force Marshal Sergey I. Rudenko, Kamanin's immediate boss, agreed on a compromise: to allow civilians to fly, but only if they passed through military medical screening and then trained at the Cosmonaut Training Center. Although Kamanin still objected, Mishin apparently found the plan agreeable, and on August 16, he wrote a letter to Kamanin explaining that civilian engineers should fly on the Soyuz spacecraft because "design solutions can only be checked by highly qualified specialists directly involved in designing and ground testing of the spacecraft. . . ."¹⁰

On August 31, the eight TsKBEM engineers led by Anokhin arrived at the Air Force's Central Scientific-Research Aviation Hospital for medical screening. Having passed through the tests, Grechko, Kubasov, and Volkov arrived at the Cosmonaut Training Center on September 5, the first group of civilians engineers in the Soviet space program to do so. The three, joined later by Yeliseyev, began training on October 1.¹¹ Makarov arrived in November. All five were accomplished engineers in their own right, participating in many of the historic events during the early space program. Grechko had helped fuel the early R-7s before launches in 1957. Makarov had been on the teams that designed the Vostok, Voskhod, and Soyuz spacecraft. For the Soyuz, L1, and L3 programs, each of these engineers were to occupy the flight engineer's seat—"the member of the crew . . . with responsibility for the correct operation of on-board systems and carrying out the flight program."¹² The remaining three from the group—Anokhin, Bugrov, and Dolgopopolov—failed to pass the Air Force's medical screening and were never considered for these Soyuz missions.¹³

The addition of civilian engineers to train for the Soyuz flights, while it did not end the battle between TsKBEM and the Air Force on the issue of cosmonaut selection, did allow Soyuz training to proceed without further disruptions. The training regime was, however, incredibly compressed. Although all the civilians had the advantage of being intimately familiar with the 7K-OK vehicle, they still had a scant three months before the docking mission, then set for early January 1967. By mid-November, Kamanin was looking at a mixed crew composed of military officers, in training for more than a year, and the new civilians.¹⁴ Ultimately, Mishin's insistence on training civilian engineers had a long-lasting legacy on the composition of crews for the next thirty years of the Soviet and later Russian space programs. During the late 1980s and throughout the 1990s, each and every crew to the *Mir* space station included a flight engineer who was a spacecraft designer from the design bureau, now known as the Energiya Rocket-Space Corporation (RKK Energiya).

Despite the arrival of the new civilian engineers at the Cosmonaut Training Center, Kamanin stubbornly remained resistant to allowing the engineers to fly on the immediate Soyuz missions. On his orders, the eight military officers continued to train for the flight, two of whom—Gorbatko and Khrunov—prepared for the EVA from one ship to another. Mishin,

9. Kamanin, "A Goal Worth Working for," no. 44

10. *Ibid.*

11. Marinin, "The First Civilian Cosmonauts."

12. Semenov, ed., *Raketno-Kosmicheskaya Korporatsiya*, p. 425, first footnote.

13. Grechko, Kubasov, Makarov, Yeliseyev, and Volkov were joined on January 8, 1967, by two more civilian engineers from TsKBEM: V. I. Sevastyanov and N. N. Rukavishnikov. Grechko dropped out of training temporarily when he broke a leg during parachute training on or about October 10, 1966. See Marinin, "The First Civilian Cosmonauts."

14. N. Kamanin, "A Goal Worth Working for" (English title), *Vozdushniy transport* 45 (1993), 8-9

however, insisted that Kubasov and Yeliseyev, two of his own men, be put on the flight for the spacewalk. On November 16, 1966, the Communist Party's Defense Industries Department Chief Serbin finally arbitrated a compromise: of the two EVA cosmonauts, one would be from the Air Force (Khrunov) and one from TsKBEM (Yeliseyev). There was some controversy over Yeliseyev's past. The Soviet security apparatus had discovered that Yeliseyev's original last name was Kureytis, a Lithuanian name. His father, Stanislav A. Kureytis, had been arrested in 1935 and spent five years in jail for "anti-Soviet agitation." Later, Yeliseyev had taken his wife's last name to put the past behind him. Evidently, the KGB let the issue go, although in past years such "tarnished" biographies had given pause to select cosmonauts for flight crews."

The remaining cosmonauts on the docking flight would all be military officers. Since September 1965, four Air Force cosmonauts had been training for the commander's spot on the two Soyuz spacecraft: veterans Bykovskiy, Gagarin, Komarov, and Nikolayev. Of them, it seems that Vladimir Komarov had been the leading contender for the commander aboard the active Soyuz, and he distinguished himself with excellent grades during mission training. Of all the flown and unflown cosmonauts, there was little doubt that he was the most technically accomplished as well as the most intellectually sophisticated member. He had originally served as a fighter pilot in the Caucasus military district during the early 1950s before joining the prestigious N. Ye. Zhukovskiy Air-Engineering Academy in August 1954. He graduated five years later, in time to join the State Red Banner Scientific-Research Institute of the Air Force with the rank of "captain engineer" of the Air Force. When he joined the cosmonaut team—that is, military unit no. 26266—in 1960, he was only one of two individuals who had graduated from Air Force academies; the rest had only finished the equivalent of American junior colleges. Komarov nearly dropped out of training early on, because of the diagnosis of an irregular heartbeat, but he had persevered and flew into space as the commander of the historic three-person Voskhod crew in October 1964. Within less than two years, he had become the sole contender for the primary crew commander's spot for the first Soyuz flight.¹⁶ At a State Commission meeting at Tyura-Tam on November 21, 1966, it was Komarov who announced the candidates for the two spacecraft. Soyuz 1 would fly with Komarov, and Soyuz 2 would fly with Bykovskiy, Yeliseyev, and Khrunov."

Yeliseyev was the sole civilian engineer from Mishin's design bureau. Bykovskiy was the veteran from Vostok 5, and Khrunov was one of the remaining unflown cosmonauts from the famous "Gagarin group" of 1960. Gagarin was, for the first time in five years, back on a backup crew. Since his first mission in 1961, he had served as more of a public relations linchpin for the Soviet space program than anything else. Some of his international duties were mitigated by his appointment in late 1963 as a deputy director of the Cosmonaut Training Center—a desk job that posited him as a leading member of the State Commissions for the Voskhod flights. In the intervening period, Gagarin had gained weight, and his flying skills seemed to have deteriorated. This was not simply Gagarin's fault: cosmonaut overseer Kamanin had continually opposed Gagarin's reassignment back to cosmonaut training. As early as April 1963, Kamanin emoted that "Gagarin hopes that someday he will fly new space missions. It is unlikely, however, that this will happen. Gagarin is too dear to mankind to risk his life for the sake of an ordinary space flight."¹⁷ Gagarin, however, pursued a second flight with unfettered vigor

15 Kamanin *Skrytiy kosmos 1964-1966* pp 385-86 389 390 391 394 395 399

16 I. Marinin "Anniversaries—Vladimir Komarov—70 Years" (English title) *Nouostr kosmonavtika* 6 (March 10-23 1997) 51-53 For details on the training program for the first Soyuz mission through 1966 see Viktor Mitroshenkov *Zemlya pod nebom* (Moscow Sovetskaya rossiya 1987) pp 385-98

17 Marinin "The First Civilian Cosmonauts" The two backup crews were Gagarin (Soyuz 1) and Nikolayev, Kubasov, and Gorbatko (Soyuz 2). Note that prior to the admission of civilian engineers (Yeliseyev and Kubasov) on the crews, two military engineers had trained for the EVA transfer: P. I. Kolodin and A. F. Voronov.

18 N. Kamanin "For Him Living Meant Flying" (English title) *Vozdushniy transport* 9 (1994) 8

and was even considered the primary contender for the Soyuz flight until April 1966, when a combination of political and personal factors forced officials to replace him with Komarov. Instead, Gagarin served as Komarov's backup."

Stumbling Toward Piloted Flight

According to the Military-Industrial Commission decree from August 1965, the Soyuz program was to set off with the first automated missions in the first quarter of 1966. Upon Mishin's official appointment as Chief Designer in May, one of his first tasks was to evaluate the state of the project, and he was remarkably optimistic, scheduling the first piloted attempt in August 1966. The plan at the time was to launch two automated Soyuz spacecraft to check the operation of all systems in robotic mode.²⁰ Needless to say, this schedule was not maintained. Throughout 1966, engineers carried out ground testing of the spacecraft at a feverish pace. Apart from static testing on stands, the Soyuz was involved in intensive dynamic design testing, work on the nominal separation of the three component modules, testing of the payload shrouds, thermal testing, checking of the operation of the life support system in pressure chambers, docking of ground models by using suspended cables in a high-altitude chamber, testing of the engine units, flight testing of the landing system, and dynamic testing of the launch escape system.

The engineers began the ground testing of the first flight model of the Soyuz spacecraft on May 12, 1966. There were many problems. Instead of the anticipated thirty days, it took four months to debug the ship. There were as many as 2,123 defects in the vehicle, significantly affecting the pace of the project. The official history of the design bureau states that the testing of the Soyuz spacecraft:

*required the solution of a number of serious scientific-technical and management problems, which arose due to the considerable complexity, as compared to the "Vostok" and "Voskhod" in the composition and logic of the functioning of the on-board systems. . . .*²¹

Among the factors that the engineers had to face were problems with the parachute system. Serious defects were identified when two out of seven drop tests from the An-12 aircraft at Feodosiya failed. After one test on August 9, when the reserve parachute failed to open, Kamanin prophetically wrote in his diaries:

One has to admit that the 7K-OK parachute system is worse than the parachute system of the Vostoks. And the spacecraft isn't much to look at in general, the hatch is small, the communications equipment is outdated, the emergency rescue system is primitive and so on. If the automatic docking device turns out to be unreliable (which cannot be ruled out) our space program will be headed for an ignominious failure."

¹⁹ On April 16, 1966, at a meeting at the Cosmonaut Training Center, officials proposed Komarov instead of Gagarin as the primary candidate for the first Soyuz flight. Gagarin was proposed as his backup. See Mitroshenkov *Zemlya pod nebom*, p. 382. In January 1966, the primary crew for the first mission was Gagarin and Voronov.

²⁰ There was also a Military-Industrial Commission decree in early 1966 that stipulated that the first two automated flights would be in August 1966, the joint piloted flight would be in September-October 1966, and the second joint piloted flight would be in November 1966. See Marinin, "The First Civilian Cosmonauts."

²¹ Semenov ed. *Raketno-Kosmicheskaya Korporatsiya*, p. 177. B. Ye. Chertok, *Rakety i lyudi* (goryachiye dni kholodnoy voyny) (Moscow: Mashinostroyeniye, 1997), p. 402.

²² Kamanin, "A Coal Worth Working for," no. 44. The parachute system was designed and built by NIEI PDS, headed by Chief Designer F. D. Tkachev.

The political pressure to return to flight was immense. As official TsKBEM historians noted later:

... it was impossible to allow a gap in the realization of piloted flights after the successful series of launches of the "Vostok" and "Voskhod" ships and it was necessary to maintain the priority in space research relative to the Americans. . . there was also pressure on the part of the government. Thus, Deputy Minister [of General Machine Building Valentin Ya.] Litvinov personally daily in the morning carried out operative meetings in the 44th assembly shop . . . and signed a list of bonuses for accelerating work.'

To oversee the test launch phase of the Soyuz spacecraft, the Soviet government established a new State Commission in October 1966, whose official title was the "State Commission for Flight-Testing of the Soyuz Spacecraft." Maj. General Kerim A. Kerimov, a forty-nine-year-old artilleryman, formerly of the Strategic Missile Forces, was appointed to head

the commission apparently to honor the late Korolev, who had originally suggested Kerimov for the post.²³ He was an odd choice for the position. Unlike the State Commissions for the Vostok, Voskhod, L1, and NI-L3, it was the first occasion when a commission chair did not have a ministerial or even a deputy ministerial rank. In fact, the actual duties of the chairs of the NI-L3, L1, and Soyuz State Commissions show a progressive decline in state importance with Minister Afanasyev (for the NI-L3), First Deputy Minister Tyulin (for the L1), and Chief of the Ministry's Third Chief Directorate Kerimov (for Soyuz), respectively. The latter was yet another former artillery expert who had gone to Germany after the war to recover German A-4s. Throughout the 1950s the native Azerbaijani had worked at Kapustin Yar before heading the first space directorate at the Strategic Missile Forces. In 1965, he quit the Strategic Missile Forces under dubious circumstances before going on to the Ministry of General Machine Building.

Throughout the summer of 1966, senior space officials met on several occasions to agree on a manifest leading up to the ambitious docking mission. Because almost all the systems on board the 7K-OK Soyuz spacecraft were automated, some members recommended that instead of two automated solo flights, engineers carry out a full-scale rendezvous and docking mission

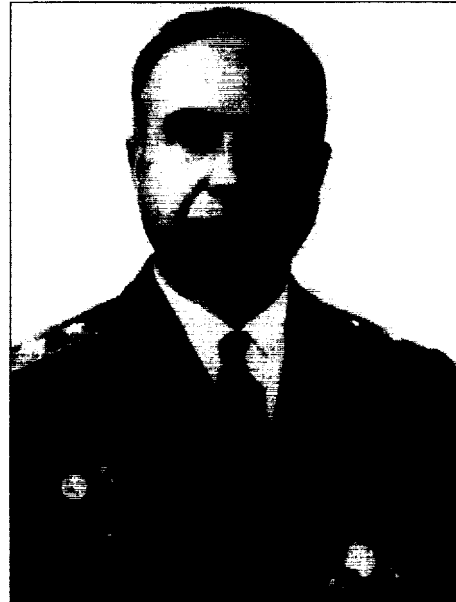

Maj. General Kerim Kerimov was the chair of the ad hoc State Commission for Soyuz from 1966 to 1991. A veteran Strategic Missile Forces officer, he officially served in several high positions in the Ministry of General Machine Building during the Soviet era. (files of Peter Gorin)

23. Semenov, ed. *Raketno-Kosmicheskaya Korporatsiya*, p. 178.

24. K. Isaakov, "Earth—Our Paternal Home" (English title), *Bakinskiy rabochiy*, August 19, 1987, p. 3; V. Ovcharov and L. Chernenko, "Recommended by Korolev" (English title), *Sovetskaya rossiya*, August 22, 1987, p. 2; S. Leskov, "Sputnik," *Komsomolskaya pravda*, October 4, 1987, p. 4; "Living History. Noteworthy Events. Rockets Go Into Space" (English title), *Sovety narodnykh* no. 4 (April 1988): 50–53; K. Isaakov, "Breakthrough into the Unknown: Today is Cosmonautics Day" (English title), *Bakinskiy rabochiy*, April 12, 1988, p. 3; Kamanin, *Skrityiy kosmos 1964–1966*, pp. 380, 383.

between the two ships. Among those in favor of such a plan was Chief Designer Armen S. Mnatsakanyan of the Scientific-Research Institute for Precision Instruments, responsible for the design and development of the *Igla* rendezvous and docking radar system. After assessing the pros and cons, Kerimov and Mishin agreed to Mnatsakanyan's suggestion. The first two automated flight models of the 7K-OK Soyuz arrived at Tyura-Tam in August 1966 for their launches in September. Further problems, however, necessitated moving the launches to November 1966. This was to be followed in January or February of the following year with the piloted mission.

On the morning of November 18, the commission met at Tyura-Tam in preparation for the upcoming dual launches set for November 26–27. Spaceship no. 2, the active Soyuz, would be launched first, followed twenty-four hours later by Spaceship no. 1, the passive Soyuz. Upon orbital insertion, if the passive ship was within twenty kilometers of the active vehicle, then docking would take place between the two ships on the passive one's first or second orbit. If the distance was greater, then the docking would occur a day later. If all systems were operating ideally, then the two spacecraft would remain docked for three days; both would land on the fourth day of their respective missions." Engineers believed that a piloted flight with the third and fourth Soyuz vehicles could be mounted as early as December 26–27. A lot of factors had to work perfectly to maintain the deadline—for example, both of the two pads (at sites 1 and 31) capable of launching the IIA511 booster would have to be available for launches. This meant that the commission would have to obtain permission from the military to delay the launch of a Zenit-4 photo-reconnaissance satellite scheduled for launch from one of those pads. The Soyuz launches would mark the first launches of the IIA511 booster, a marginal modification of the earlier IIA57 launch vehicle used for Voskhod.

A final State Commission meeting took place on November 25, by which time the two launches were set for November 28 and 29. On launch day, Kamanin wrote:

We've been waiting for this to happen for more than four years (the industry delayed the manufacture of the spacecraft because they were overautomated: they have to be able to link up even if unmanned). Today and tomorrow will see launches on which the immediate future of our space program will hinge: all the Moon spacecraft are based on Soyuz."

The first Soyuz spacecraft lifted off successfully at 1600 hours Moscow Time on November 28, 1966, from Tyura-Tam. It entered an initial orbit of 181 by 232 kilometers at a 51.9-degree inclination; the perigee was lower than expected because of the less-than-stellar performance from the new launch vehicle. The Soviet news agency TASS designated the spacecraft *Kosmos-133* and, as was customary, did not indicate that the flight had any connection with the piloted space program. Problems beset the mission almost immediately. As soon as the payload separated from the booster, the pressure in the tanks of the mooring and orientation engine system dropped from 340 atmospheres to thirty-eight atmospheres in 120 seconds. Within less than fifteen minutes, all or most of the propellant in the system had been used up, sending the spacecraft into a slow rotation of two revolutions per minute. Given that these engines were indispensable for attitude control during approach and docking, there was little hope of carrying out a docking with a second Soyuz. Kerimov and Mishin immediately decided to cancel the preparations for the second launch and instead focus efforts on bringing *Kosmos-133* back to Earth.

The spaceship had more problems. The mooring and orientation system thrusters were required not only for rendezvous and docking but also to position the spacecraft into correct attitude to fire the main deorbit engine. On Deputy Chief Designer Chertok's suggestion,

25 Kamanin, "A Goal Worth Working for," no. 45; Chertok, *Rakety i lyudi goryachiye dni kholodnoy voyny*, p. 412; Kamanin, *Skrytiy kosmos. 1964–1966*, p. 396.

26 Kamanin, "A Goal Worth Working for," no. 45, p. 8

ground controllers at Yevpatoriya decided to use a backup set of attitude control engines linked to the backup main engine. A test of these small thrusters, however, showed that they turned the ship in an opposite direction to the one commanded—that is, they could not be used for reentry attitude orientation either. Kosmos-133 seemed to be stranded in orbit. Preliminary ballistics projections showed that the spacecraft would decay naturally after about thirty-nine orbits, in which case the automatic self-destruct system would blow up the vehicle during descent because of an incorrect orientation.

Given these almost insurmountable problems, the Chief Operations and Control Group found an ingenious way to work around them. The flight control team decided they could use a third set of tiny thrusters, the orientation engines, which were used only for minor attitude control, to position the vehicle correctly for short time periods. Thus, instead of firing the main S5.35 engine for a full 100 seconds for reentry, the controllers would fire it in short bursts of about ten to fifteen seconds while the orientation engine system maintained proper attitude. The cumulative effect of several of these short firings would be the same as one long burn—that is, sufficient to deorbit the spacecraft safely. There was, however, little hope of bringing the ship back to a preselected target area."

In the early morning of November 29, after extensive consultations with Chertok at Yevpatoriya and with Deputy Chief Designer Bushuyev in Moscow, the State Commission opted to try for a reentry on the seventeenth orbit using a combination of the automatic solar orientation system, the orientation engine system thrusters, and the main engine. Controllers apparently doubted whether all the correct commands had been sent to the spacecraft at the time, and Mishin decided to call off the attempt and not take the risk. Attempts to bring the ship down on the eighteenth and nineteenth orbits using ionic attitude control sensors did not succeed either. Kamanin in his journal recorded that the controllers fired the engine two times, but each time the unit cut off after ten and thirteen seconds, respectively. A third burn to change Kosmos-133's orbit to shift its landing track over Soviet territory also prematurely cut off after twenty seconds, apparently because the ship was not properly stabilized during the firing. It remains unclear whether these aborted burns were deliberate firings to guide the ship in for deorbit or failed attempts at reentry. Ultimately, the State Commission decided to delay the landing for another day to wait for the following opportune landing opportunity on Soviet soil.²⁸

On the morning of November 30, on the spacecraft's thirty-second orbit, the controllers carefully sent commands for new engine firings to be carried out on the succeeding orbit. But on the thirty-third orbit, the main engine apparently shut down prematurely again. A fifth engine firing on the thirty-fourth orbit using the ionic sensor system did the job: the spacecraft was sufficiently slowed down to begin orbital decay. Kosmos-133 separated into its three component modules and began reentry, but the descent apparatus abruptly disappeared from radar screens about seventy to 100 kilometers over Earth, 200 kilometers southeast of the city of Orsk. An extensive visual search by the Air Force's search service ended without result. Later, the State Commission ascertained that the descent trajectory had been too flat and the capsule had begun to overshoot Soviet territory and head toward China. The self-destruct system, consisting of twenty-three kilograms of TNT, exploded automatically and destroyed the capsule. Debris apparently rained down on the Pacific Ocean east of the Mariana Islands." The mission had lasted about one day, twenty-one hours.

27 Chertok *Rakety i lyudi goryachye dni kholodnoy voyny* pp 416-19

28 Kamanin *Skrytyy kosmos 1964-1966* pp 414-16

29 *Ibrd* pp 416-17 Leonard Nikishin "Soviet Space Disaster on the Revolution's Anniversary: How and Why Cosmonaut Komarov Died" *Moscow News* 9 (March 1-8 1992) 16 Kamanin "A Goal Worth Working for" no 45 *I Mannin ' Soyuz '30 Years Since the First Flight'* (English title) *Novosti kosmonavtiki* 24 (November 18-December 1 1996) 64-65

Although the flight could hardly have been considered successful, the mission did give engineers and controllers on the ground a chance to evaluate the operation of all the Soyuz systems in realistic conditions. The ionic orientation system was stable, the main engine could be fired repeatedly in vacuum, and the spacecraft could be reentered despite faulty stabilization. Based on an analysis of the problems, many State Commission members, including Chairman Kerimov, Mishin, and Ryazanskiy, believed that Kosmos-133 could have been safely recovered if there had been a cosmonaut on board instead of a mannequin. Four investigation commissions, which included Chief Designer Ryazanskiy, Deputy Chief Designer Tsybin, and Department Chief Raushenbakh, reported their findings on December 8. There had been three major failures on the ship: the complete spurious exhaust of the propellant in the mooring and orientation engine system; insufficient stabilization of the spacecraft when the deorbit engine was fired; and a failure of the Tral telemetry instrument on the fifteenth orbit. They found that the failures had nothing to do with design flaws but rather problems in assembling and testing that particular model on the ground. The service lines for the jet vane controls of the orientation engines were evidently tangled up, and a faulty system was installed on the vehicle. During reentry, the retro-engine had fired for less than a nominal period because of the lack of vehicle stabilization, which itself was a result of the faulty orientation system. The State Commission recommended that the second Soyuz, the passive 7K-OK, be launched no later than December 18 on a solo flight. *Igla* system Chief Designer Mnatsakanyan opposed a solitary launch and continued to insist on an automated docking flight, but he was overruled by Mishin, who apparently regretted following Mnatsakanyan's advice to mount a joint flight on Kosmos-133. If all went well, cosmonauts would fly into space aboard two different Soyuz vehicles in late January or early February."

The pace at Tyura-Tam was intense. A little more than two weeks later, the remaining Soyuz spacecraft, vehicle no. 1, was ready for launch, this time from the pad at site 31. The launch was set for 1430 hours local time on December 14, 1966. At the count of zero, shards of flame shot out from the base of the 11A511 booster, but they were suspiciously smaller and less powerful than normal. The rocket remained fixed on the pad, and those present assumed that computers had aborted the launch at the last minute because of a then-unknown glitch. The flames at the base died down soon, and steam filled the area as thousands of gallons of water poured onto the launch mount. Approximately twenty-seven minutes after the abort, observers saw the launch escape system suddenly start firing. At this point, there were many pad workers who were engaged in "safing" the booster, as was customary following a launch abort. Although the rocket seemed to remain inert, within a few seconds, the flames from the escape system directly engulfed the lower portion of the Soyuz spacecraft and the booster's third stage below. As the fire spread, scores of workers near the pad took cover in their bunkers. Kamanin described the scene:

I ran to the cosmonauts' house and ordered everyone who was there to quickly go from the rooms into the corridors. It proved to be a timely measure: within seconds a series of deafening explosions rocked the walls of the building which was located 700 meters from the pad. Stucco fell down and all the windows were smashed. The rooms were littered with broken glass and pieces of stucco. Fragments of glass hit the walls like bullets. Clearly, if we had remained in the rooms a few seconds longer we would all have been mowed down by broken glass. Looking out through the window openings I saw huge pillars of black smoke and the frame of the rocket devoured by fire. . . .³¹

30 Kamanin, "A Goal Worth Working for," no. 45; Semenov, ed., *Raketno-Kosmicheskaya Korporatsiya* p. 179; Marinin, "Soyuz' 30 Years Since the First Flight "

31. Kamanin, "A Goal Worth Working for." no. 45, p. 9.

State Commission members met about twenty minutes later at the Soyuz assembly-testing building, but among those missing were Mishin, Kerimov, and Maj. General Kirillov, the Chief of the First Directorate at the Baykonur Cosmodrome. As concern mounted for the missing individuals, Baykonur Commander Maj. General Aleksandr A. Kurushin quickly sent an emergency medical team to the launch pad area to search for survivors. Within a short time, Mishin, Kerimov, and Kirillov turned up safe at another command bunker. The Soyuz descent apparatus miraculously landed safely at a distance from the pad without incident.

On December 16, an investigation commission reported on the probable causes of the terrible accident. It seems that when the command to ignite had been sent to the booster, only the second stage of the IIA511 launcher (that is, the strap-ons) had fired, and computers had instantly aborted the launch. After the announcement for pouring water around the launch mount, Mishin and Kirillov had concluded that it was safe to egress from their bunkers because all engines on the booster were shut down. Ground control then sent a command to relocate the escape frames of the pad structure onto the vehicle to prevent the launcher from swaying in the gusty winds present at the time. By this point, many service personnel had already arrived at the pad to climb up the service tower to inspect the rocket. As the frames were lifted near the booster, one of these touched the booster prematurely and tilted it. This occurred because the launch vehicle had moved very slightly from its original position at the launch abort. As soon as the booster tilted, the emergency rescue system was automatically triggered by gyroscopes, which detected a vertical angle exceeding seven degrees. The ninety-ton solid-fuel engine of the system fired on command, and its long exhaust penetrated the Soyuz propellant tanks on top of the booster: at that point, all service personnel fled the area in panic. It took almost two minutes between the firing of the system and the final explosion of the first and second stages of the booster—a length of time that no doubt saved the lives of most of those who were close to the booster, including Mishin, Kerimov, and Kirillov. Most managed to run as much as 150 to 200 meters to safety, while Mishin and the others fled to a nearby bunker. A Major Korostylev unfortunately took refuge behind the concrete walls of the launch assembly and, as a result, became the sole fatality in the accident. Several others were severely injured. The entire pad complex and associated structure was completely destroyed."

At the meeting on December 16, Mishin admitted that the design of the emergency rescue system had been fundamentally faulty because the gyroscopes could trigger the operation of the system even when all power was cut off to the booster. Remarkably, just three days prior to the explosion, engineers carried out a test of the rescue system at the Air Force's test site at Vladimirovka near Kapustin Yar. Because the goal of the test was not to check fire safety, the tanks of the spacecraft were left empty for the firing of the rescue system engines. A fueled spaceship could have easily precluded such a disaster. Engineers introduced a number of design changes on the rescue system based on the recommendations of the accident commission, including ensuring that the solid-propellant engine of the system could be turned off manually or remotely immediately after aborts."

The explosion and destruction of an IIA511 booster, a Soyuz spacecraft, and the pad at site 31 significantly delayed any hope of mounting an early piloted Soyuz mission. Another automated Soyuz flight was inserted into the schedule, to be carried out on January 15, 1967, from the other remaining pad at site 1. Mishin had ordered re-equipping one of the piloted versions for the solitary robotic mission. The piloted mission was postponed to March—a delay accounted for by the time needed to transform the pad at site 1 to support dual Soyuz launches. In the meantime, on December 21, Kamanin sent the eight primary and backup cosmonauts for

32 *Ibid* Nikishin "Soviet Space Disaster"

33 Semenov ed *Raketno Kosmicheskaya Korporatsiya* pp 179-80

the first mission, who had been intensively training through November and December, on a short vacation.³⁴ The year would end without a single Soviet piloted flight, the first such year since crewed spaceflight was inaugurated by Gagarin in 1961.

The next Soyuz spacecraft, a passive 7K-OK, vehicle no. 3, was prepared for its two-day mission in late January 1967. The State Commission met on January 19 in Moscow before flying to Tyura-Tam starting January 23." Mishin was evidently ill for the two weeks preceding the launch, set for February 6, and was not present at many of the technical meetings. Due to minor technical reasons, the launch was delayed exactly twenty-four hours, and the vehicle lifted off successfully from the pad at site 1 at 0620 hours Moscow Time on February 7, 1967. Initial orbital parameters were 170 by 241 kilometers at a 51.7-degree inclination. TASS announced the flight as Kosmos-140, another in a long series of nondescript generic satellites with no particular mission. One of the unusual payloads aboard the ship was a cryogenic superconducting magnet on board for the analysis of charged particles. The Soviets later claimed that this was the first such instrument launched into space to study cosmic rays." Communications were interrupted briefly during the powered ascent, but they were restored once in orbit, which was once again lower than intended because of the less-than-nominal booster performance.

Trouble began to appear on the fourth orbit. The vehicle failed to respond to a command to orient itself to turn the solar panels to face the Sun to recharge the on-board batteries. The astro-orientation sensor system used for this maneuver had evidently malfunctioned. Worse, propellant levels in the attitude control system had dropped to 50-percent levels during this test. After anxious consultations, the State Commission decided to raise the orbit and try one more time to test the sensor system, which used the 45K solar-stellar sensor. On the twenty-second orbit, the Soyuz main engine fired for fifty-eight seconds, but the spacecraft failed to respond to the "spin up to the Sun" command, and all the propellant in the main attitude control system was spent. By the end of the day, commission members were looking to terminate the flight early. Once again, most members believed that the failures on Kosmos-140 were only in systems that had duplicates for manual control, such as "spinning up" and the astro-orientation system. All of these malfunctions could have been compensated by cosmonauts." The remaining systems such as life support, the main engine, thermal control, and so on, worked without problems.

The State Commission decided to use the ionic sensor system of orientation to posit the vehicle in the correct attitude prior to retrofire. The designer of the system, TsKBEM Department Chief Raushenbakh, had little confidence in the device, because he believed that the main engine might misfire as a result of exhaust, which could disorient the ionic sensors. Luckily for everyone, the system worked without a flaw, and the descent apparatus of Kosmos-140 began its reentry.

Following deorbit, the search-and-rescue service received faint signals from the descent apparatus, which were evidently originating from the Aral Sea, far west of the intended landing site. It was apparent by then that the capsule had automatically changed its landing profile from a guided reentry to a ballistic return. About four hours after landing, searchers discovered the descent apparatus eleven kilometers from Cape Shevchenko, lying on an iceberg in the Aral Sea.

34 Mitroshenkov *Zemlya pod nebom* p 397 Among the cosmonauts training for 7K OK missions by late December were the eight men for the first mission (Bykovskiy Gagarin Corbatko Khrunov Komarov Kubasov Nikolayev and Yeliseyev) as well as four other cosmonauts training for future missions (Beregovoy Makarov Shatalov and Volkov)

35 *Ibid* pp 399-400

36 V P Glushko ed *Kosmonautika* entsiklopediya (Moscow Sovetskaya entsiklopediya 1985) pp 201-02 Yu A Mozzhorin ed *Kosmonautika* (Moscow Mashinostroyeniye 1981) p 446

37 Kamanin "A Coal Worth Working for" (English title) *Vozdushniy transport* 46 (1993) 8-9

It was the first sea landing for a Soviet piloted vehicle. Unfortunately, soon after the rescue teams discovered the capsule, it sank through the ice to a depth of about ten meters. It seems that the capsule had crashed through the iceberg and floated in the resulting hole until it became water-logged and simply sank. Engineers back in Moscow were naturally alarmed by the news, because the descent apparatus had been repeatedly tested for floatation in case of a water landing.

The recovery of the capsule proved to be extremely difficult, and the Air Force had to call in a team of divers. Helicopters were not able to lift the capsule because it was too heavy. With much difficulty, an Mi-6 helicopter managed to accrue sufficient horizontal velocity to drag the thing the three kilometers back to the shore. In their postflight analysis, engineers discovered a thirty- by ten-millimeter hole at the center portion of the bottom of the vehicle, which was sufficient for loss of pressure and the subsequent sinking. The investigation showed that the hole was the result of an infringement of the unity of the heat shield, which had been cast off. The heat shield itself had a maintenance hole with a plug attached with special glue for a thermal gauge pipe. The plug was incorrectly mated to the heat shield, resulting in a chain of events that led to the hole in the spacecraft. If a crew had been on board, they would have died, since Soyuz crewmembers would not be wearing spacesuits during reentry. To address the problem, engineers eliminated the plug completely from the heat shield, and they also made the heat shield a monolithic structure instead of being assembled piece by piece. In addition, all "suspect" areas of the heat shield were reinforced with extra material as a cautionary measure. At a meeting on February 16, Mishin and Bushuyev reassured the State Commission that the necessary measures would be carried out to preclude such an accident from happening again."

Soyuz I

From an outsider's perspective, the natural course of action for the State Commission would have been to add another precursor Soyuz mission to the schedule. The two spacecraft flown in 1966 and 1967 had significant problems, primarily in their reentry phase, and certainly there would have been the need to verify the operation of all the components of reentry, such as the heat shield, parachute system, reentry orientation systems, and so forth. Despite the three attempts to launch the 7K-OK Soyuz, Mishin and his engineers recovered only a single descent apparatus after a space mission—one whose thermal protection system had a catastrophic failure. This is not to say that Mishin did not undertake a thorough analysis of the situation. The results of the three Soyuz attempts were the subject of intense discussion; the main decision for the engineers was whether to carry out another automated mission or whether to go directly to a piloted mission. Deputy Chief Designers Konstantin D. Bushuyev and Yakov I. Tregub of TsKBEM led this analysis in February and March 1967. Mishin invited a host of representatives from all organizations involved in the Soyuz program to hear their individual assessments of the status of their particular system and its potential readiness for a piloted flight. Remarkably, most of the other designers and engineers recommended crewed flight. Among the dissenters was TsKBEM Department Chief Ivan S. Prudnikov, who based his objections on the insufficient testing of the new, improved heat shield. The majority of engineers, however, expressed confidence in the work of the heat shield."

38 *Ibid* Semenov ed *Raketno Kosmicheskaya Korporatsiya* p 180 Nikishin "Soviet Space Disaster"
G Salakhutdinov "Once More About Space" (English title) *Ogonek* 34 (August 18-25 1990) 4-5

39 Semenov ed *Raketno Kosmicheskaya Korporatsiya* pp 180-81

On March 25, 1967, Chairman Smirnov's Military-Industrial Commission met to discuss the preparations for the mission. Representing the State Commission, five men spoke on the flight, including Chairman Kerimov, Mishin, and Kamanin.⁴⁰ Smirnov asked several questions, including: "Do you think the equipment will work smoothly?" Kamanin replied:

Three launches of Soyuz spaceships and the completion of all ground tests *have* made us confident that the flight will be successful, although at one point some of the cosmonauts had certain doubts about the ship's bottom. We know that following the burn-out of the bottom of ship no. 3, the Central Design Bureau of Experimental Machine Building has worked hard to reinforce *it*. Chief Designer *Mishin* has said on more than one occasion that now there should be no doubts about the bottom. We believe *Mishin*.⁴¹

Kamanin introduced all the cosmonauts preparing for the flight: the eight primary and backup crew members—Bykovskiy, Cagarin, Corbatko, Khrunov, Komarov, Kubasov, Nikolayev, and Yeliseyev—as well as four additional understudies who were expected to fly a subsequent Soyuz mission after finishing their training on June 1.⁴² Although there was no formal decision on the primary crew, Komarov (for Soyuz 1) and Bykovskiy, Yeliseyev, and Khrunov (for Soyuz 2) were the leading candidates. Mishin personally met with Ustinov two days later to discuss the flight, setting in motion a series of events that would cripple the Soviet space program.⁴³

The decision to move ahead with the docking mission has been obfuscated and mired in controversy and speculation for thirty years. One TsKBEM engineer, who later emigrated to the United States in the 1970s, added to the rumor mill by recalling that:

The management of the Design Bureau knew that the vehicle had not been completely debugged: more time was needed to make it operational. But the Communist Party ordered the launch despite the fact that four preliminary launches had revealed faults in coordination, thermal control, and parachute systems. *It* was rumored that Vasilii *Mishin*, the deputy chief designer who headed the enterprise after *Korolev's* death in 1966, had objected to the *launch*.⁴⁴

There was clearly much political pressure from Brezhnev and Ustinov to get the flight off the ground. It had been almost two years since a piloted Soviet spaceflight, while the Americans had flown ten Gemini missions. In addition, May Day, one of the most important holidays in Soviet culture, was imminent, and there is reason to believe that the Soyuz flight was timed to roughly coincide with the anniversary. A simple automated flight of the vehicle

40 Kamanin 'For Him Living Meant Flying' The other two speakers were Maj General A G Karas (Commander of the Central Directorate of Space Assets) and Maj General A I Kutasin (the Air Force head for rescue and recovery operations)

41 *Ibid* p 8

42 The four understudies were probably Beregovoy, Makarov, Shatalov, and Volkov

43 There was apparently also a State Commission meeting the same day. See *Mitroshenkov Zemlya pod nebom* p 404

44 Victor Yevisikov *Re Entry Technology and the Soviet Space Program (Some Personal Observations)* (Falls Church VA: Delphic Associates, 1982) p 4. See also Dmitriy Payson "Eternal Soyuz—Today Marks the 25th Anniversary of the First Docking in Orbit" (English title) *Nezavisimaya gazeta* January 15, 1994 p 6 in which the author states "The Soyuz was hastily prepared for launching and it was launched (an unprecedented act!) despite the categorical refusal of Vasilii Mishin"

would have hardly mattered for such an auspicious occasion. When asked in an interview in 1990 whether he had been pressured to carry out the mission. Mishin replied:

*Truly, there never was a time when we worked in peace. without being hurried or pressured from above. The unskilled, totally bewildered, high-ranking bureaucrats believe that they are fulfilling their duties if they are shouting "Let's go, let's go!" at people who don't even have time to wipe the sweat off their brows.*⁴⁵

Asked about the possibility that his deputies may have committed errors during the preparations. Mishin emphasized:

No. the deadlines and the pressure *from above* have nothing to do with that. Not a single supervisor (or any of the Soyuz systems) would have given the "go-ahead" to the flight if he were not certain of that system's satisfactory operation."

Ultimately, it was a decision motivated by the apparently huge lag in piloted space exploration accrued through 1965 and 1966 as compared to the United States. Throughout 1966, both the political and technical managers of the Soviet space program banked on the inauguration of the Soyuz program to take some steam out of U.S. space achievements, which finally seemed to have gained momentum after years of humiliation. When Mishin, Bushuyev, Tregub, and others recommended a go-ahead with the flight, clearly they did not have full confidence in their ship. Korolev, of course, had also taken his own risks, particularly with the two Voskhod missions, which were highly risky endeavors. The EVA mission of Voskhod 2, for example, was not preceded by a successful precursor mission. But Soyuz was a far more complex spacecraft; it was a completely untested quantity in terms of crewed operations. The Soyuz mission was a gamble of extraordinary levels.

The intensive discussions on Soyuz in February and March 1967 were mirrored by the slowly increasing number of rumors emanating from "unofficial" sources from the Eastern bloc that a Soviet space spectacular was imminent. On March 7, a commentator on Prague Radio reported that "much more complicated manned operations in Earth orbit are about to begin which have taken over two years to prepare." Just two days later, Lt. General Kamanin, in a long interview with Warsaw Radio, said that piloted flights would begin again that spring. He added that the Soviets were not locked onto any particular date and that the flight would come only when they were assured of success. He implied that the deaths recently of the three American astronauts were the result of unnecessary haste in the U.S. space program, a factor absent in the Soviet space program.⁴⁶

After an unusually grueling training program involving countless hours in simulators on the ground, the eight primary and backup cosmonauts for the mission took their final exams for the flight on March 30, and all passed with excellent marks. On April 6, the men visited the depths of the Kremlin to meet with high Central Committee officials and receive wishes of good luck. The same day, Kamanin, accompanied by veteran and rookie cosmonauts, flew into Tyura-Tarn.

⁴⁵ Salkahutdnov 'Once More About Space' p. 4

⁴⁶ *Ibid*

⁴⁷ Soviet Space Programs 1966-70 Goals and Purposes Organization Resources Facilities and Hardware Manned and Unmanned Flight Programs Bioastronautics Civil and Military Applications Projections of Future Plans Attitudes Toward International Cooperation and Space Law prepared for the Committee on Aeronautical and Space Sciences U.S. Senate 92d Cong 1st sess (Washington DC U.S. Government Printing Office December 1971) p. 364

⁴⁸ *Ibid* Peter Smolders *Soviets in Space* (New York: Taplinger Publishing Co. 1973) p. 150



The crews of Soyuz 1 and Soyuz 2 present themselves before the State Commission in front of the launch pad in April 1967. In the foreground from left to right are the primary crew of Vladimir Komarov, Valery Bykovskiy, Yevgeniy Khrunov, and Aleksey Yeliseyev (in civilian clothes) and the backup crew of Yuriy Gagarin, Andrian Nikolayev, Vrktor Gorbatko, and Valery Kubasov (also in civilian clothes). Chief Designer Valentin Glushko is visible in the background between Yeliseyev and Gagarin. (copyright Christian Lardier)

Komarov followed on April 8 and Gagarin on April 14.⁴⁹ For many, it was the first time that they had spent the celebrated "Cosmonautics Day," the anniversary of Gagarin's pioneering flight, at the Baykonur Cosmodrome.

There was a meeting of the State Commission on April 14 at which the members decided to begin fueling the two launch vehicles and spacecraft. Assuming an eight-day period for complete preparation, the first launch was tentatively set for April 24–25. Mishin telephoned both Ustinov and Brezhnev later; Ustinov evidently expressed some anxiety over the impending flight. The mission would be inaugurated by the launch of the active 7K-OK Soyuz 1, on the first day, with Komarov. The following day, as the ship was flying over Tyura-Tam, the passive 7K-OK Soyuz 2 would be launched with Bykovskiy, Yeliseyev, and Khrunov. The two spacecraft would dock on the very first orbit of Soyuz 2; it would be the first docking of two piloted spaceships. After docking, Yeliseyev and Khrunov would exit from their depressurized living compartment and crawl over to the depressurized living section of Soyuz 1. Following the transfer, Soyuz 1, with a crew of three, would return the following day. Soyuz 2, with a crew of one, would also return that same day. Apart from the dramatic nature of the flight, the mission had significant value for future operations in the NI-L3 project as well as possible Earth-orbit rendezvous profiles for the circumlunar LI program.

⁴⁹ Mitroshenkov, *Zemlya pod nebom* pp 405–06. Among the cosmonauts accompanying Kamanin were rookie G. T. Beregovoy and veterans A. A. Leonov, and P. R. Popovich. Note that another source states that the primary and backup crews arrived at the launch site on April 10, 1967. See Grigoriy Reznichenko, *Kosmonaut 5* (Moscow: Politicheskoy literatury, 1989), p. 97.

The EVA itself had been the subject of much discussion for months. In November 1966, two of Mishin's Deputy Chief Designers, Sergey O. Okhapkin and Pavel V. Tsybin, proposed having one cosmonaut move away from the docked vehicles to a distance of about ten meters to photograph the complete complex and the second cosmonaut. After opposition by some of the cosmonauts, TSKBEM opted for the use of a ten-meter boom to ensure that the vehicles would be photographed—a problem entrusted to Deputy Chief Designer Bushuyev.⁵⁰ By the time of the actual mission, Bushuyev had abandoned the idea, possibly projecting its use on a later Soyuz docking mission. The cosmonauts on this first flight would simply crawl from ship to ship. There were other changes to the spacewalk schedule. TSKBEM engineers had apparently designed the hatch on the Soyuz ship with too small a diameter (0.66 meters). This would be barely enough for a spacesuited cosmonaut to egress from the ship and make it all but impossible for the men to get back into the second ship. Mishin and his boss, Deputy Minister Litvinov, were categorically opposed to redesigning the hatch to a larger size for the first few Soyuz vehicles, believing that a redesign would delay the initial launches by months. Instead, at a meeting on August 4, 1966, attended by Chief Designers Mishin (spacecraft) and Severin (spacesuits), officials decided to move the *Yastreb* EVA suit backpacks from the cosmonaut's back to the waist. Mishin promised that future Soyuz ships, beginning from vehicle no. 8, would have larger hatches." Such changes added an extra level of tension to an already hurried situation. Just a week prior to the launch, on April 15, Kamanin wrote in his journal:

I am personally not fully confident that the whole program of flight will be completed successfully, although there are no sufficiently weighty grounds to object to the launch. In all the previous flights we believed in success. Today there is not such confidence in victory. The cosmonauts are prepared well, and the ships and the instruments have gone through hundreds of tests and verifications, and all seems to have been done for successful flights. but [still] there is no confidence. This can perhaps be explained by the fact that we are flying without Korolev's strength and assurances; we were spoilt by Korolev's optimism."

The fueling of the Soyuz 1 launch stack began at 2300 hours Moscow Time on April 15. The morning of April 17, the cosmonauts attended a final five-hour class under Raushenbakh's supervision to study once again the modes of docking, orientation, and so on. In the afternoon, Mishin arrived to talk personally with the crews about various portions of the mission. Even at this late point, there seems to have been some disagreement over which mode of operation to use for the crucial docking maneuver. Mishin favored a completely automatic docking, believing in the infallibility of the ship, but he was opposed by Kamanin and some of the cosmonauts, including Komarov and Gagarin. For more than two years, Bykovskiy, Gagarin, Komarov, and Nikolayev, the four commanders, had been training for an automatic approach followed by a manual docking and were reluctant to let automation do the whole thing. At the meeting, Komarov argued that the Igla system could automatically bring the active vehicle within 200 to

50 Kamanin *Skrytiy kosmos 1964–1966* pp 396–97 400

51 *ibid* pp 355–361 Present at the August 4 meeting were S. M. Alekseyev (Chief Designer of KB Zvezda) K. D. Bushuyev (Deputy Chief Designer of TSKBEM) N. P. Kamanin (Space Aide to the Commander in Chief of VVS) V. A. Kazakov (Deputy Minister of MAP) V. M. Komarov (Cosmonaut of TsPK) V. Ya. Litvinov (Deputy Minister of MOM) V. P. Mishin (Chief Designer of TSKBEM) C. I. Severin (Chief Designer of KB Zvezda) N. S. Stroyev (Director of the M. M. Cronov Fight-Research Institute) and P. V. Tsybin (Deputy Chief Designer of TSKBEM)

52 Lev Kamanin and Aleksandr Nernov "Komarov's Star: The Tragic Details of the Testing of the Soyuz 1 Space Ship" (English title) *Poisk* 5 (June 1989) 4–5

300 meters of the passive vehicle, following which he could manually dock the two spacecraft. Mishin listened to their arguments and delayed a final decision on the matter until the following day. By the end of the day, the fueling of the Soyuz 1 launcher had concluded while the fueling of the Soyuz 2 booster had begun. Thus, the launching was informally set for April 24-26."

The Council of Chief Designers met on the morning of April 18 to discuss the docking issue. State Commission Chairman Kerimov supported an automatic approach via the Igla to fifty to seventy meters, followed by manual docking, although many engineers still defended the fully automatic variant. TsKBEM Department Deputy Chief and cosmonaut Feoktistov mediated the issue and argued in favor of the semi-automatic profile, and the council accepted his recommendations. Later in the day, Feoktistov discussed various contingency measures for emergency situations with the cosmonauts. The final State Commission meeting prior to launch took place on April 20 at site 2. The launch of Soyuz 1 was set for 0335 hours Moscow Time on April 23, while the launch of Soyuz 2 was set for 0310 hours Moscow Time the following day. All the Chief and Deputy Chief Designers confirmed that the launch vehicles, space ships, and support services would be completely ready to accomplish the launch on time. The commission also formally approved the crews for the two missions and gave the official go-ahead for the flight."

On April 22, the IIA511 rocket was already at the launch pad at site 1. In the late morning, the primary and backup crews had their customary meeting with the launch command and industrial representatives. A number of chief designers met with the crews and informed them that after the Soyuz 1 launch, there would only be two reasons for a postponement or cancellation of the Soyuz 2 launch: if there was a failure in the Igla system or if there was a low charge in the solar batteries on Soyuz 1. Kamanin counseled Komarov that the most important factor on the mission would be safety: in the case of any malfunctions, there would be no need to proceed with the complicated docking procedure. Later in the day, Komarov attended a press conference for journalists with special access. Komarov dedicated his flight to the fiftieth anniversary of the Bolshevik Revolution."

A final meeting of the State Commission, lasting forty-five minutes, began one-half hour before midnight and concluded with recommending a full go-ahead for the flight. Komarov woke up about two hours after midnight, and doctors attached sets of medical sensors to his body. He was dressed in a plain light woolen gray suit and a blue jacket. At 0300 hours, he arrived at the pad to give a short speech to State Commission Chairman Kerimov and then embraced senior officials goodbye. Mishin, Kamanin, and Gagarin accompanied him to the rocket; Gagarin went up with him all the way to the top of the rocket and remained there until the hatch closed.

There were no anomalies prior to launch. The spacecraft, 7K-OK no. 4, lifted off exactly on time at 0335 hours Moscow Time on April 23, 1967, with its sole passenger, forty-year-old Colonel Engineer Vladimir M. Komarov. He was the first Soviet cosmonaut to make a second spaceflight. It took 540 seconds for the ship to successfully enter orbit. The official Soviet news agency TASS released a brief statement, calling the flight *Soyuz 1*, and announced the orbital parameters and some vague objectives of the program. Characteristically, there was no mention of the impending Soyuz 2 mission. Rumors in the West, however, had reached crescendo proportions, some clearly indicating that a docking with a second ship was planned.⁵⁶ Cosmonaut Popovich

53 Ibid There was a minor delay on April 18 when a valve on one of the systems for loading nitric acid into the spacecraft failed. The problem was fixed without much delay.

54 Ibid

55 Ibid Soviet Space Programs 1966-70 p 18 Mitroshenkov *Zemlya pod nebom* p 407

56 For a summary of these rumors see James Oberg "Soyuz 1 Ten Years After" *New Conclusions* "Spaceflight 19 (May 1977) 183-89

informed Komarov's wife, Valya, that her husband was in orbit about twenty-five minutes after launch. She told reporters that "my husband never tells me when he goes on a business trip."⁵⁷

For the first time on a Soviet piloted mission, the Chief Operations and Control Group—that is, the flight control team—was located at the Scientific-Measurement Point No. 16 at Yevpatoriya in Crimea. A team of twenty controllers, including TsKBEM Deputy Chief Designers Chertok and Tregub and Department Chief Raushenbakh, assisted Chief Operations and Control Group Chief Colonel Pavel A. Agadzhanov, the "flight director." The flight control team would actively communicate with the spacecraft in orbit while maintaining continuous contact with the State Commission, all of whose members remained behind at site 2 at Tyura-Tam. Additional ballistics support was provided by NII-4's military control center in Moscow.

The initial incoming report from telemetry streams from two ground stations indicated that the Soyuz spacecraft's left solar panel had not opened upon entering orbit. As Agadzhanov's team examined the data, they found other anomalies. A backup antenna in the telemetry system was inoperable and the 45K solar-stellar attitude control sensor's optical telescope had probably been contaminated by engine exhaust. While the antenna was a minor annoyance, the sensor malfunction was serious because without it, Soyuz 1 would be unable to orient the ship properly to change orbital parameters in preparation for the rendezvous and docking. Telemetry indicated that current orbital parameters were 196.2 by 225 kilometers at a 51° 43' inclination. It was on the second orbit that controllers first established stable communications with Komarov on ultra-shortwave frequencies; for reasons unknown, the shortwave system was inoperable. Komarov calmly reported:

I feel well. The parameters of the cabin are normal. The left solar battery has not opened. There's been no spin toward the Sun. The "solar current" is 14 amperes. Shortwave communications are not working. Attempted to manually perform spinning. Spinning did not occur, but pressure in the [orientation engines] dropped to 180.⁵⁸

Unconfirmed reports suggest that Komarov even tried to knock the side of the ship to jar open the recalcitrant panel. Already, the situation had deteriorated dramatically. Because one solar panel was not operative and the ship had failed to automatically orient the other toward the Sun, power on board the ship was far below normal. Power experts at Yevpatoriya had calculated that the buffer batteries could operate with the current levels of power up to the seventeenth orbit, after which Komarov could use reserve batteries for up to two more orbits. This meant that Soyuz 1 could safely operate for about a day, significantly less than the three days needed for a docking mission. In the meantime, Agadzhanov told Komarov to shut down nonessential systems and to try at all costs to orient the right panel toward the Sun. On the third orbit, Komarov told ground control that the left panel was still folded against the ship and that the vehicle had not oriented toward the Sun. Current had stabilized at a low fourteen amperes, far below that required for a nominal flight. The 45K attitude control sensor was still inoperative. Despite the troubles, the State Commission believed that the orientation problem would be solved, and it recommended that preparations for the launch of Soyuz 2 be continued. Kamanin meanwhile sent Cagarin directly to Yevpatoriya to assist the Chief Operations and Control Group in its operations.⁵⁹

⁵⁷ Smolders *Soviets in Space* p 156

⁵⁸ Kamanin and Nemov. "Komarovs Star" Chertok *Rakety i lyudi goryachiye dni kholodnoy uoyny* pp 444-45

⁵⁹ Kamanin and Nemov "Komarovs Star" M F Rebrov *Kosmicheskiye katastrofy* (Moscow Izdat 1993) p 27 Chertok *Rakety i lyudi goryachiye dni kholodnoy uoyny* pp 445-46

On the fifth orbit, Komarov attempted to manually orient the ship by using Earth's horizon to position the vehicle at correct attitude, but he found it difficult to do so, partly because it was difficult to keep a target hold on the moving Earth. In addition, his attempt seems to have been overruled by the on-board control system. Apart from the astro-orientation system, which used the 45K solar-stellar sensor, and the manual orientation system, the vehicle was also equipped with ionic sensors. The use of these, however, also met with little success on the fifth orbit. From the seventh to the thirteenth orbits, Komarov was outside radio visibility using ultra-shortwave communications because the spacecraft would pass over the Atlantic and the American continent. As planned earlier, Komarov was ordered to sleep during this period, while consultations among Moscow, Tyura-Tam, and Yevpatoriya continued throughout the day at a feverish pitch.

Most of the senior members of the State Commission, including Chairman Kerimov, Keldysh, and Kamanin, recommended the immediate postponement of the Soyuz 2 launch and the return of Komarov at the earliest possible opportunity—that is, the seventeenth orbit. Incredibly, Mishin still had hope and believed that the commission should make a final decision on the thirteenth orbit, once Yevpatoriya reestablished contact with Komarov. There was even a plan to have the two EVA cosmonauts, Yeliseyev and Khrunov, manually unfurl the jammed solar panel during their spacewalk from one ship to the other. But on the thirteenth orbit, Komarov reported that his second attempt to use the ionic orientation system had failed." He added that the left solar panel was still jammed: current on the ship had remained static at twelve to fourteen amperes. Mishin later recalled that "because of the emergency, the shortage of power on board caused a chain of problems [including] a change in the temperature conditions." Immediately, the State Commission unanimously canceled the Soyuz 2 launch. Evidently, the Soyuz 2 cosmonauts were bitterly disappointed, blaming the commission for "excessive caution and indecisiveness."⁶²

The problem at that point was how to return the spacecraft from orbit, nominally on the seventeenth orbit, but with the eighteenth and nineteenth orbits as reserve. Agadzhanov's team at Yevpatoriya considered the matter carefully. There were three main failures on board Soyuz 1: the unopening of the left solar panel, the failure of the ionic orientation system, and the malfunction of the 45K solar-stellar attitude control sensor. The recalcitrant solar panel not only deprived the spacecraft of much-needed power, but also caused an asymmetry in the ship, which prevented the open solar panel from facing the Sun. Because of this mechanical imbalance, engineers were all but sure that all of Komarov's efforts to spin the ship in the direction of the Sun would fail and, in fact, would simply waste the precious propellant in the orientation engine system. If there was too little fuel in this system, then during retrofire, Komarov might not be able to compensate for moments arising from the mass displacement because of the single opened panel.

The Soyuz had three orientation systems. If all three orientation systems were inoperative, it would be practically impossible for Komarov to return his ship. With an incorrect attitude, Soyuz 1 would either burn up in the atmosphere or fly into a higher orbit. The ionic orientation system had already failed to perform twice. Engineers also believed that the system would be

60. Kamanin and Nemov. "Komarov's Star": Russian Space History. Sale 65 16 (New York: Sotheby's, 1993). description for Lot 46: Reznichenko. Kosmonavt-5, p. 97. One source suggests that Komarov may have actually tried to fire his main engine to change his orbit. In Nikishin, "Soviet Space Disaster," the author notes "The first orbital correction was widely off mark because the maneuver thrusters' exhaust affected the operation of the attitude control system's ion sensors."

61. Salakhutdinov. "Once More About Space"

62. Rebrov, *Kosmicheskaya katastrofy*, pp. 27-28

unreliable during the morning hours when the return was planned because of ion pockets, which could disrupt the work of the sensors. As for the 45K solar-stellar sensor, it was not functioning at all. This left manual orientation, which was working, but as Komarov reported, it was extremely difficult to manipulate in Earth's shadow because it would be difficult to locate Earth's horizon. Normally, using manual orientation, the cosmonaut would cross Earth's terminator into lighted areas. In Komarov's case, with a reentry at the earliest opportunity, he would still be in the dark."

Time was already running short for Komarov. If he was to perform a successful reentry on the seventeenth orbit, then Agadzhanov's team needed to transmit a precise set of commands to Komarov on the sixteenth orbit. It was already the fifteenth orbit, and officials at both Yevpatoriya and Tyura-Tam were still arguing over a proper choice of orientation for reentry. It had been almost twenty-four hours since the launch, and not one member of either the State Commission or the Chief Operations and Control Group had slept. In their state of alarm, members continuously violated established rules to communicate only via secret channels between the two centers. On the fifteenth orbit, Komarov reported that he believed that the ionic system and its associated attitude control engines were in working order. Based on his recommendations and assessment from data on the ground, the State Commission recommended that the ship be landed on the seventeenth orbit using the automatic ionic orientation with the backup set of orientation engines. Agadzhanov, Raushenbakh, and Chertok carefully checked over the set of instructions that Gagarin personally transmitted to Komarov. In the final seconds before loss of contact, Mishin and Kamanin both wished Komarov good luck.⁶⁴

At the appointed time, Soyuz 1 initiated the reentry sequence. The main engine was supposed to fire for deorbit at 0256 hours, 12 seconds Moscow Time on April 24, but nothing happened. Ballistics reports pouring into Yevpatoriya indicated that Soyuz 1's orbital parameters had remained the same. Once communication with Komarov was reestablished, the cosmonaut reported that the ion system seemed to have worked fine, but evidently, as the ship had crossed the equator, it had flown into an "ion pocket" in Earth's shadow where the concentration of the ions was less than what the sensors could detect. The ship's control system correctly issued a command to prohibit the firing of the retro-engine.⁶⁵ State Commission members decided to immediately begin preparations for another landing attempt on the eighteenth orbit. As the seventeenth orbit was ending, however, the flight control team did not have any new instructions ready to transmit to Komarov. Finally, the State Commission decided to land Komarov on the nineteenth orbit.

With the use of both the ionic and solar-stellar orientation systems out of the equation, the only remaining option was for Komarov to manually orient the ship prior to retrofire, but using a very complex series of operations in orbit. Komarov would have to orient the ship manually to Earth's horizon in the light portion of the orbit. Just before entering Earth's shadow, he would transfer attitude control to the spaceship's KI-38 gyroscope system. Once he was out of the shadow, he would check to see whether Soyuz 1 was still correctly oriented for retrofire. If not, he would once again take over manual control and issue all the commands to complete the retrofire sequence for a landing on the nineteenth orbit. It was an incredibly difficult task—one for which none of the cosmonauts had ever trained on the ground. One of the power specialists warned at the time that Komarov had one to two orbits at the most—that is, he might not have very many more chances to attempt reentry. Gagarin once again transmitted the new set of instructions to the Soyuz 1 cosmonaut. Komarov seemed calm and agreed to carry

63 Chertok *Rakety i lyudi goryachye dni kholodnoy uoyny* pp 446-47 Kamanin and Nemov 'Komarov's Star

64 Chertok *Rakety i lyudi goryachye dni kholodnoy uoyny* p 447

65 *Ibid* Nikishin 'Soviet Space Disaster' Kamanin and Nemov 'Komarov's Star

out all the operations on time, which would lead to a 150-second retrofire with engine ignition at 0557 hours, 15 seconds on April 24.

Komarov performed skillfully and carried out his assigned program almost to the letter. He replied through the increasing static, "The engine worked for 146 seconds. Switch-off occurred at 0559 hours 38.5 seconds. At 0614 hours 9 seconds, there was the command 'Accident-2'."⁶⁶ The "Accident-2" signal threatened to give controllers a collective heart attack, but Raushenbakh gathered his resolve and explained to the team not to worry. The attitude control system had been unable to handle the strong moments because of the asymmetry of the vehicle, and the gyroscopes had issued the "Accident-2" command after the spacecraft deviated from its set angle by eight degrees. That only meant that instead of a guided reentry, Komarov would perform a direct ballistics return. All other parameters, such as the length of the burn, were well within range for a successful reentry.

At Tyura-Tam, the members of the State Commission were huddled together on the second floor of the administrative portion of the huge assembly-testing building at site 2. Journalists at the launch site were excluded from the meeting but were able to overhear voices. Cosmonaut Leonov served as an intermediary to brief reporters on the ongoing situation. Mishin, Kerimov, Keldysh, Minister Afanasyev, and Air Force First Deputy Commander-in-Chief Marshal Rudenko all exchanged brief comments as they heard Komarov's report. About fifteen minutes after retrofire, there was the expected break in communications as Komarov's capsule entered an ionization layer. A few minutes later, Komarov's voice cut through the radio silence; he evidently sounded "calm, unhurried, without any nervousness."⁶⁷ By this time, Kamanin and a group of Air Force officers had already taken off from Tyura-Tam in an 11-18 aircraft to head for the projected landing range—the reserve landing area for the mission, about sixty-five kilometers east of Orsk, far west of the planned site for a guided reentry. According to ballistics data, Soyuz 1 had landed at 0624 hours Moscow Time.

Once search services determined the landing site, the reserve search-and-rescue service at the town of Orenburg was called into operation to locate the descent apparatus. It was a beautiful and sunny morning at the landing site, and visibility was evidently very good. Members of the rescue service recalled that:

The commander of one of the An-12 search aircraft reported to the helicopter commander that he could see Soyuz-1 in the air. All the group members were immediately at the windows. But we couldn't see the reentry vehicle descending in the air. The helicopter commander began a rapid descent. Then the helicopter turned sharply to the right, and many of the group members saw the reentry vehicle down in a green field. It was lying on its side, and the parachute could be seen right next to it. And then the soft-landing engines kicked in. That alarmed the specialists on the helicopter, because the engines were supposed to switch on just before the landing of the reentry vehicle, right above the ground.⁶⁸

The first helicopter landed seventy to 100 meters from the capsule, which was surrounded by a cloud of black smoke. The fire inside the vehicle was still very intense, while the bottom of the ship, where the soft-landing engines were, had completely burned through. Witnesses claimed that streams of molten metal were falling on the ground. Along with foam fire extinguishers, they used dirt around the ship to temper the fire: "The vehicle was completely

66 Chertok. *Rakety i lyudi goryachye dni kholodnoy voyny*, p. 448

67 Rebrov. *Kosmicheskiye katastrofy*, p. 28

68. Iosif Davydov. "How Could That Have Been?: Slandered Space" (English title), *Rosstryskaya gazeta*, June 11, 1992, p. 5. Author's emphasis.



This shows the wreckage of the Soyuz 1 descent apparatus immediately after the crash. Cosmonaut Vladimir Komarov's body was still buried within the wreckage at the time of this photograph. (Rudy Inc. via Quest magazine)

destroyed while the fire was being extinguished, and the spot looked like a small earthen mound, beneath the peak of which was the cover for the hatch-crawlyway."⁶⁹

The rescue service originally communicated on an open channel with ground controllers at Moscow, Tyura-Tam, and Yevpatoriya, although they spoke in code. Once the rescuers had seen the ship on the ground and on fire, one of the pilots had cryptically reported. "I see the object, the cosmonaut needs urgent medical attention out in the field."⁷⁰ At that point, perhaps to preclude rumors, the search service terminated all communications with the three control centers. For the next few hours, there was no news from the site as Mishin, Kerimov, and others anxiously waited for any scrap of news.

Kamanin, meanwhile, landed at Orsk airport about two hours after the Soyuz 1 impact, fully expecting to meet Komarov there. Once out of his plane, he was told that the ship had landed sixty-five kilometers away, that it was burning, and that the cosmonaut had not been found. Another unconfirmed report came in that Komarov was wounded but alive in a hospital at a town three kilometers from the landing site. The Air Force general decided to go directly to the landing site first, although he had been explicitly ordered to wait for a call from Moscow to report on Komarov's status. Back at the three control centers, there was complete confusion. Ustinov in Moscow was frantic for information. He began calling up Party secretaries in Orenburg and Orsk on special lines, but could not reach anyone. Although the vehicle had landed at 0624 hours, Ustinov received no information on the state of the cosmonaut for the next three and a half hours.

When Kamanin arrived at the landing site, the Soyuz 1 descent apparatus was still on fire. He was not the first high-ranking space official on the scene. Academician Georgiy I. Petrov, the Director of the Space Research Institute of the Academy of Sciences, had arrived there first and was directing efforts to assess the situation. There was still no sign of the cosmonaut. Local

⁶⁹ *Ibid*

⁷⁰ Nikishin "Soviet Space Disaster" Note that in Semenov ed. *Raketno Kosmicheskaya Korporatsiya* p. 181 the first detection is said to have been from an 11-14 aircraft while Nikishin "Soviet Space Disaster" suggests that it was from a helicopter

residents reported that the ship had fallen toward Earth at a great speed and that the parachute was turning and not filled up with air. They confirmed the observations of the search-and-rescue service that at the moment of landing, there were some explosions followed by the fire. Kamanin recalls:

A cursory examination of the ship convinced me that Komarov was dead and was still in the remains of what used to be his ship. I ordered to clear out the debris on the ground and search for Komarov's body. Simultaneously I sent one of the workers by helicopter, and others by automobile to the local hospital in order to verify the story of the injured cosmonaut. After an hour of excavations [that is, at around 0930 hours] we discovered the body of cosmonaut Komarov among the remains of the ship. . . .⁷¹

Finding the body had been a difficult job. One of the rescuers recalled:

The group's physicians set to work — they shoveled away the top layer of dirt from the top of the mound from the hatch cover. After the dirt and certain parts of instruments and equipment were removed, the cosmonaut's body was found lying in the center chair. The physicians cleaned the dirt and the remnants of the burned helmet phone from the head. They pronounced the death to be from multiple injuries to the cranium, spinal cord, and bones."

Meanwhile, Kamanin flew back to Orsk and personally telephoned Central Committee Secretary Ustinov with the following short message:

I was at the location, cosmonaut Komarov has died, the ship burnt up. The primary parachute of the ship did not open, and the reserve parachute did not fill with air. The ship hit the ground at a speed of 35–40 meters per second: after impact there was an explosion of the braking engines and a fire started. I was not able to report on the fate of the cosmonaut earlier since nobody could see anything, and during that time we extinguished the fire in the ship by covering it with dirt. Only after carrying out excavations were we able to find Komarov's body."

At noon on April 24, Ustinov called Soviet General Secretary Brezhnev, who was at an international conference of communist parties in Czechoslovakia, with information on the accident. Ustinov also edited a TASS report, which was issued after a full twelve hours of silence from the Soviet press. The official line was that although the flight had been eventless until reentry. "when the main parachute was deployed at a height of 7 kilometers, the spaceship, according to preliminary reports, crashed at great speed as a result of the parachute cords getting entangled, [and] killed Komarov."⁷⁴

In the early afternoon, State Commission members Kerimov, Keldysh, and Chief Designers Mishin, Tkachev, and Severin arrived at the impact point escorted by KGB agents. Soon, senior engineers from TsKBEM, including Deputy Chief Designer Tsybin and specialists involved in Soyuz development, arrived to catalog and inspect the entire landing area. Komarov's remains were taken in a coffin back to Moscow, arriving an hour after midnight on April 25. Aboard the aircraft were Keldysh, Kamanin, and the other cosmonauts who had trained for the mission:

71. Kamanin and Nernov. "Komarov's Star." p 5

72. Davydov. "How Could That Have Been?," p 5

73. Kamanin and Nernov. "Komarov's Star." p 5.

74. Smolders, *Soviets in Space*. p 159

Bykovskiy, Gagarin, Gorbalko, Khrunov, Kubasov, Nikolayev, and Yeliseyev. They were met in Moscow at the airport by Komarov's widow Valentina Yakovlevna Komarova. His remains were then cremated and the urn placed in the Red Banner Hall of the Central House of the Soviet Army for mourners to pay homage. The next day, the Soviet Party and government gave him a state funeral with full honors, and his ashes, like Korolev's, were interred in the Kremlin Wall. In a grisly aside to his death, not all of Komarov's remains were found during the initial search, and a group of Young Pioneers, the equivalent of Boy Scouts in the Soviet Union, discovered additional remains that were later buried at the crash site itself. Reportedly, Party officials took great pains to hide this fact from the general public."

The death of Vladimir Mikhaylovich Komarov was a catastrophic blow to the Soviet space program. Apart from the pure psychological cost of losing a cosmonaut on a space mission, the disaster immediately stopped all three major Soviet piloted space projects—the Soyuz, the L1, and the L3. Any hope of accomplishing a circumlunar flight by late 1967 was in great doubt, while landing a Soviet cosmonaut on the Moon by late 1968 was sheer fantasy at this point. The blow to morale was incalculable, not only to the design bureaus, institutes, and military units involved in the project, but also to the nation as a whole. It was bitter news to swallow that the first Soviet piloted spaceflight after two years had ended in tragedy, in the process losing perhaps the Soviet Union's most accomplished spacefarer. At the spot where Komarov landed, Party officials later collected the remaining tiny fragments of his last ship and erected a small hill. Sergey N. Anokhin, the famous Soviet test pilot, who at the time was the head of the testing department at TSKBEM, placed Komarov's officer's cap in the hill, after which a gun salute sounded out, paying tribute to what many considered a fallen hero of the Soviet Union.

All further piloted flights were indefinitely canceled at the time. On April 27, Ustinov met with the leading space industry representatives and established a special governmental commission headed by himself to determine the causes of the accident. This commission included seven subcommissions. One of them, to investigate the landing itself, was headed by the recently appointed Director of the M. M. Gromov Flight-Research Institute, Viktor V. Utkin, a respected aeronautical engineer. The commission included two representatives from TSKBEM, Chief Designer Mishin and Deputy Chief Designer Bushuyev. Soyuz 1 and 2 backup cosmonauts Gagarin and Bykovskiy also served as members."

Utkin's subcommission finished its work, which included some experimental analyses, by June 20 and emerged with the cause of the accident: a release failure of the container block of the primary parachute. The parachute was packed in a container whose hatch was jettisoned, releasing a "braking" or drag parachute, slowing down the vehicle to a manageable forty meters per second, sufficiently slow to allow the primary parachute to fill up with air instead of shredding. The drag parachute itself was supposed to pull out the main parachute, but it did not do so because the latter had gotten jammed in the container. Under nominal circumstances, automated instruments on board the capsule would have detected an increase in velocity, discarded the primary drag and main parachutes, and activated the backup system. On Soyuz-1, once instruments detected the velocity increase, the capsule was unable to discard the primary chute because it was still stuck in the container. This meant that the primary drag chute was still deployed above the spacecraft. Once the single backup parachute was released, it was to have come out in the shape of a long, thin cylinder and then unfurl to its dome shape. In Komarov's case, the backup chute began to extend under the still attached drag parachute from

75 Semenov ed *Raketno Kosmicheskaya Korporatsiya* p 181 Kamanin and Nemov 'Komarov s Star' Nikishin 'Soviet Space Disaster'

76 Semenov ed *Raketno Kosmicheskaya Korporatsiya* p 182 Chertok *Rakety i lyudi goryachiye dni kholodnoy voyny* p 453 For Gagarin see Mitroshenkov *Zemlya pod nebom* p 411 For Bykovskiy see Reznichenko *Kosmonaut* 5 p 97

the primary system, and it never filled with air. Without any means of braking, the ship plummeted and hit the ground at a velocity of 144 kilometers per hour (forty meters per second). An autopsy of Komarov confirmed that he died on impact with the ground and that the effects of the fire were secondary. Despite rumors to the contrary, Komarov did not cry or scream before the impact, although during the last seconds, he was surely aware that he had little chance to live." Because of the rapid velocity of descent, the frontal heat shield was never discarded at an altitude of three kilometers, and the soft-landing engines never fired prior to touchdown. Those engines, in fact, detonated after landing, burning with the thirty kilograms of concentrated hydrogen peroxide from the capsule's attitude control engines. From launch to impact, Komarov's ill-fated flight had lasted one day, two hours, forty-seven minutes, and fifty-two seconds.

The commission discovered that the reason that the primary parachute never issued was because of friction within the container between the parachute and the inside walls of the container. The increased pressure within the parachute container relative to the low pressure outside the vehicle caused the parachute to simply block up against the insides of the container. This effect was never detected on four drop tests of the parachute system prior to the flight. As late as 1990, however, Chief Designer Mishin continued to believe that the parachute had been incorrectly packed during preparations. The solar panel failure was later traced to the panel getting snagged on the external vacuum-shield cover of the spacecraft. The 4SK attitude control sensor had failed because of a "steam-up" of its optical surface. The commission recommended redesigning the parachute container by making it conical instead of cylindrical, increasing its internal volume, and polishing the inside walls. Additional measures would include installing an autonomous node for separating the primary drag chute and photographing the assembly of the parachute packages."

There was also an unofficial and more likely version of the cause of the accident—one that attributed the accident to gross negligence on the part of technicians at TsKBEM's manufacturing plant. During preflight preparations, the two Soyuz ships had been coated with thermal protection materials and then delivered into a high-temperature test chamber to polymerize the synthetic resin. In the case of the two Soyuz ships for the April 1967 mission, technicians tested the vehicles in the chamber with their parachute containers, but apparently without the covers for the containers. In Deputy Chief Designer Chertok's investigation of the matter in the early 1990s, he could not find anyone still alive who could remember why the covers had been left off. Because of the omission of the covers, the interiors of the parachute containers were coated with a polymerized coating, which formed a very rough surface, thus eventually preventing the parachute from deploying on Soyuz 1.⁷⁹ Clearly, the most chilling implication of this manufacturing oversight was that both Soyuz spacecraft were doomed to failure—that is, if Komarov had not faced any troubles in orbit and the Soyuz 2 launch had gone on as scheduled, all four cosmonauts would have certainly died on return.

The unofficial cause of the accident was never included in the official report on Soyuz 1, partly because those at the manufacturing plant who knew of the violation of testing procedure chose to remain silent on the issue so as not to incriminate themselves. The one major casualty of the post-Soyuz 1 investigation was Chief Designer Tkachev of the Scientific-Research and

77 Rebrov. *Kosmicheskiye katastrofy*. p. 29. Semenov, ed., *Raketno-Kosmicheskaya Korporatsiya*. p. 182. Nikishin, "Soviet Space Disaster." Note that Davydov, "How Could That Have Been!" gives the impact velocity as twenty-six to thirty meters per second (ninety-four to 108 kilometers per hour). Most Western sources quote the incorrect 450 kilometers per hour.

78. Semenov, ed., *Raketno-Kosmicheskaya Korporatsiya*. p. 182: Chertok. *Rakety i lyudi goryachiye dni kholodnoy uoyuny*. p. 457: Salakhutdinov, "Once More About Space."

79 Semenov, ed., *Raketno-Kosmicheskaya Korporatsiya*, p. 182: Chertok. *Rakety i lyudi goryachiye dni kholodnoy uoyuny*. p. 457

Experimental Institute of the Parachute-Landing Service who had designed the Soyuz parachute system. Although the unofficial version clearly exonerated his organization of any blame, Tkachev was fired from his job in 1968, ending his role in designing the parachute systems for Vostok, Voskhod, Zenit, Soyuz, and many other Soviet spacecraft of the era. Two parachute testing failures following Soyuz I apparently sealed his fate.⁸⁰ He was replaced by Chief Designer Nikolay A. Lobanov.

In retrospect, the Soyuz I flight should not have been carried out at that time. The spacecraft was insufficiently tested in space conditions, and it was certainly not ready for the ambitious first mission it was scheduled to accomplish. Although participants continue to deny that there was explicit pressure from Brezhnev, Ustinov, and Serbin to accomplish the flight as soon as possible, the implicit pressure had a much more imposing effect. It was not just a matter of Soviet prestige in space exploration, it was also the fact that perhaps many of the leading designers' jobs were on the line. When Brezhnev or Ustinov complained about the lack of Soviet successes in space, it translated into political pressure on Mishin, Kerimov, Keldysh, and others. Thus, both sides made decisions that were counterproductive and eventually had fatal consequences for the Soviet space program. All told, the responsibility and guilt for the accident lay not on the conscience of any one person, but rather on a technological culture that considered high risks acceptable in the cause of satisfying political imperatives.

A Diamond . . .

The Soyuz I disaster crippled the three major Soviet piloted space programs in the mid-1960s: the Soyuz, the L1, and the L3. While these were the central components of Soviet efforts to compete with the United States in space, these were not the only ones. There was, in fact, a huge parallel effort aimed at piloted military operations in space—one that was completely hidden from view, and whose existence, as with most other Soviet space projects, was unknown until the late 1980s. The Soviet military, left out of the Soyuz, L1, and L3 programs, had promoted its own participation in space research by financing projects dedicated to establishing a Soviet military human presence in space. These efforts were motivated to a great extent by perceptions about the U.S. Department of Defense's well-publicized conceptions of a military space program. After several years of intensive research, President Lyndon B. Johnson canceled the X-20A Dyna-Soar spaceplane program in December 1963. Opinions at the time were moving in favor of a military space station in Earth orbit capable of supporting multicrewed long-duration missions. Preliminary work on such a vehicle, later named the Manned Orbiting Laboratory (MOL), began in late 1963, concurrent with the termination of the X-20A program, although official approval did not come until President Johnson's announcement on August 25, 1965.⁸¹

The underlying concept behind the U.S. Air Force's MOL was the use of a modified Gemini spacecraft named the Gemini-X (later referred to as the Gemini-B), which would be launched together with the Mission Test Module (later the Laboratory Module) as a single unit by a Titan IIIC launch vehicle. Once in orbit, astronauts would open a hatch in the heat shield of the Gemini-B vehicle and crawl into the Laboratory Module for a month-long mission. By the time that Johnson made his announcement, MOL's primary goal was overhead reconnaissance, primarily over the Soviet Union. Other tasks emerged later, including satellite inspection, accuracy testing of orbital bombardment systems, command and control over military operations during wartime, assessing the effects of month-long missions on humans, and electronic intelligence reconnaissance."

80 Chertok *Rakety i lyudi goryachye dni kholodnoy voyny* p 458

81 Paul B. Stares *The Militarization of Space US Policy 1945-1984* (Ithaca NY Cornell University Press 1985) p 98

82 William E. Burrows *Deep Black Space Espionage and National Security* (New York Berkley Books 1988) p 227 Donald Pealer 'MOL Part I Manned Orbiting Laboratory' *quest* 4(3) (Fall 1995) 4-16

Plans for MOL caused of much anxiety in the USSR Ministry of Defense. On August 24, 1965, the day before Johnson's announcement, the Central Committee and the Council of Ministers issued a joint decree calling for the expansion of military research in space." By this time, the Soviet Union had already begun the development of a specialized, piloted vehicle exclusively for military purposes, the *Soyuz-R*, which was a small "space station" consisting of a modified Soyuz docked to another modified Soyuz. Work on the *Soyuz-R* had proceeded from about 1963 to 1965 at Korolev's Branch No. 3 at Kuybyshev under the direct command of branch chief Dmitriy I. Kozlov, one of Korolev's proteges. The appearance of the MOL seems to have quashed Kozlov's hopes as the Ministry of Defense's General Staff began looking for a more substantial military presence in space. They found a willing provider in General Designer Chelomey, whose proposals seem to have originated from a combination of the Soviet's own desire for crewed reconnaissance and their fear of MOL. It was rumored that Khrushchev had a "fixation" on U.S. aircraft carriers and desired a Soviet response, perhaps some way to keep track of them. Apprised of the MOL effort, Chelomey emerged with a mirror concept: a space station containing sophisticated reconnaissance equipment, including powerful radars to track U.S. naval forces."

On October 12, 1964, just two days before Khrushchev's overthrow, Chelomey gathered all his deputies and proposed the creation of a new Earth-orbital complex named *Almaz* ("Diamond"). The twenty-ton station would be crewed by two to three military officers on a rotating basis and launched by a three-stage UR-500K booster, better known as the Proton. The station was intended for operation for about one to two years, during which time cosmonauts would conduct experiments and scientific activities formulated by the Ministry of Defense, primarily consisting of photographic and visual reconnaissance." With the MOL project clearly accelerating, Kozlov's modest Soyuz-R proposal was no match for Chelomey's Almaz. In early 1966, the Scientific-Technical Council of the Ministry of Defense's General Staff reviewed both projects on a competitive basis and decided to recommend Almaz for formal approval. All the technical documentation on Soyuz-R was turned over to Chelomey for planning and designing the Almaz complex.⁸⁶

As projected in 1966-67, the Almaz complex consisted of two elements: a space station proper called the Orbital Piloted Station (OPS), or ОПС, and a transport ship to bring crews back and forth between Earth and the station. Originally, Chelomey had proposed a large cargo ship based on the design of the Almaz and about as large, but this proposal was not adopted by the Scientific-Technical Council. As an alternative, Chelomey used Kozlov's transport ship for the Soyuz-R complex, a modified 7K-OK Soyuz spaceship named the 7K-TK. On March 30, 1966, Minister of General Machine Building Afanasyev formally assigned TsKBEM's Branch No. 3 under Kozlov to design and build this modified Soyuz to serve as a ferry vehicle for the Almaz complex. It was the second occasion on which the Mishin and Chelomey design bureaus would undertake significant cooperation with each other despite a competitive rivalry extending back to 1960. Kozlov, using the 7K-OK vehicle as a basis, quickly completed the draft plan for the 7K-TK the same year and began working on preparing the technical documentation for the manufacture of the ship.⁸⁷

83. K. Lantratov. "Dmitriy Kozlov's 'Zvezda': Part II" (English title). *Nouostr kosmonavtika* 4 (February 10-23, 1997) 82-84

84. Roald Z. Sagdeev, *The Making of a Soviet Scientist: My Adventures in Nuclear Fusion and Space From Stalin to Star Wars* (New York: John Wiley & Sons, 1993), pp. 206-07

85. I. B. Afanasyev. "Unknown Spacecraft (From the History of the Soviet Space Program)" (English title). *Novoye v zhizni: Nauke, tekhnike. Seriya kosmonavtika, astronomiya* no. 12 (December 1991), 1-64.

86. K. Lantratov. "Dmitriy Kozlov's 'Zvezda' Part I" (English title). *Nouostr kosmonavtika* 3 (January 27-February 9, 1997) 50-55. The chair of the Scientific-Technical Council of the Ministry of Defense's General Staff at the time was Lt. General N. N. Alekseyev.

87. *Ibid*

One of the major bottlenecks in the Almaz program was incorporating a wide variety of systems as specified by various factions within the Ministry of Defense. Technical requirements were revised over and over again, causing significant delays. For example, on December 28, 1966, the Military-Industrial Commission adopted a decree (no. 304) to change the timelines for the 7K-TK transport ship's development. By 1967, Chelomey completely dropped Kozlov's transport ship from the Almaz plan—a decision perhaps partly motivated by a reluctance to cooperate with the old Korolev design bureau. The Almaz space station, the OPS, would include its own large return capsule for the crew. At the same time, Chelomey continued to promote his old idea of a separate transport craft to deliver crews to the station at a later date. During this period, the Soviet government established an "interdepartmental" commission of seventy renowned scientists, heads of design bureaus, and research institutes from the aviation industry and the Ministry of Defense to evaluate the design of the Almaz complex. Their recommendation and high appraisal of the technical characteristics of the plan were critical to the further progress of the project. The final details of the Almaz design were frozen by June 21, 1967, when Chelomey signed the draft plan for the spacecraft, which consisted of more than 100 volumes of technical documentation from twenty-five major design bureaus. Two months later, on August 14, 1967, the Central Committee and the Council of Ministers issued a joint resolution fully committing to the project.⁸⁸

The central component of the Almaz complex was the OPS (11F71), a space station just under twenty tons that was composed of three sections:

- The return apparatus (11F74)
- The station proper (11F75)
- A small recoverable capsule (11F76)

The station proper was shaped like a long cylinder with sections of two different diameters: a large-diameter (4.15 meters) portion and a small-diameter portion. It had a mass of fifteen tons and a length of 11.61 meters. The small-diameter section was in the forward portion of the station and would be enclosed during launch by a conical nose fairing. The large-diameter area was at the aft of the station and ended in a spherical airlock with a passive docking port, called *Konus*, along the main axis of the station for visiting spacecraft. There was a hatch between the airlock and the large-diameter area, allowing for depressurization for spacewalks. EVAs would be carried out via a large hatch at the upper portion of the spherical airlock. There was a second smaller hatch at the lower end of the airlock that connected to a chamber containing a small drum-shaped recoverable capsule, the 11F76, which was capable of being ejected from the station and returning to Earth with the exposed film and other scientific materials. Once the capsule was packed with its payload, the crew would spin-stabilize the pod and then eject it from the OPS. The one-meter-long capsule had its own solid-propellant propulsion system for reentry, a parachute system, a jettisonable heat shield, and the actual descent compartment equipped with a radio beacon for recovery forces on the ground.

There were antennas as well as two main engines positioned around the airlock on the end of the large-diameter portion for orbital corrections. Each RD-0225 engine with a thrust of 400 kilograms was developed by the Chemical Automation Design Bureau (formerly OKB-154) under Chief Designer Aleksandr D. Konopatov. Power for the station was provided by two large

⁸⁸ *Ibid.*, Vladimir Polyachenko, "The 'Pep' of Almaz" (English title), *Krylya rodiny* no. 1 (January 1992) 18-19; Afanasyev, "Unknown Spacecraft", Olaf Przybilski, *Almaz: Das supergeheimer militärische Orbitalstationsprogramm der UdSSR* (Dresden, Ger.: Institut für Luftfahrt, 1994), pp. 16-17. The Ministry of General Machine Building had issued an earlier decree on Almaz on February 9, 1967.



This is a model of the military Almaz space station on display. This model is of the original variant of the space station with the large Çemini shaped reentry capsule attached on the forward end (to the right). This capsule was later deleted from the station. The folded up solar panels are on the left surrounding the single docking port of the station. (copyright Dietrich Haeseler)

solar panels spread like wings to a span of 22.8 meters, whose bases were attached to the spherical compartment. The panels would provide 3.12 kilowatts of power. The entire aft end of the station was surrounded by a cone-shaped shield made of vacuumed thermal insulation.

Cosmonauts would dock at the aft docking port, open the hatch into the spherical airlock, and crawl through a short tunnel into the large-diameter area. The tunnel itself was enclosed all around by a stubby instrument compartment containing spherical propellant tanks for the OPS main engines, the engines themselves, pressurized gases, and small attitude control thrusters.

Going back toward the station, there was the large-diameter area that had a control console, a work station, an optical sight allowing the cosmonauts to "freeze" the movement of Earth below and observe specific details, and periscopes allowing for the inspection of the space around the station. Instruments were designed and installed as detachable modules to facilitate easy repair. The compartment also included athletic instrumentation and the toilet. The centerpiece of the large-diameter area was the *Agat-1*, optical telescope, a large device that occupied a considerable portion of the compartment. The telescoping camera had a focus length of 6.375 meters and was certainly one of the largest mirrors ever put into orbit. In the open media, Russians have claimed that the resolution was less than three meters, but given the size of the mirror, it is more likely that the telescope was capable of distinguishing targets smaller than one meter. The cosmonauts would use *Agat-1*, in conjunction with the ASA-34R wide-film camera, to photograph targets on Earth, develop the film on the station, conduct an analysis, and send back the more militarily important ones directly to Earth via a TV link, all within about thirty minutes. The remaining photographs would arrive on Earth in the 11F76 recoverable capsule. Other optical instruments on the station included the OD-5 optical viewfinder, the POU-II panoramic instrument for wide coverage of Earth's surface, topographic and stellar apparatus, and the *Volga* infrared instrument with a resolution of 100 meters.

Heading further to the aft of the station, the cosmonauts would enter the smaller diameter section, which was the crew living compartment containing sleeping areas with deployable bunks, a dining table and chair, a food storage area, and viewports for photography. For the first time on a Soviet piloted spacecraft, the life support system included a device, designated *Priboy* ("Surf"), with the capability to recycle water from air humidity.

One of the most interesting components on the station was motivated by concerns among Soviet military leaders that the United States might attack such an explicitly military space station in orbit. Given the paranoia about U.S. military space plans, Chelomey agreed to the military's proposal to install a means to defend the station in case of such an attack. Under a

contract. the Design Bureau of Precision Machine Building (formerly OKB-16) under Chief Designer Aleksandr E. Nudelman designed a twenty-three-millimeter-caliber rapid-fire cannon for the station. Cosmonauts would be able to use a gunsight to turn the station and aim the cannon at a selected target. Nudelman's previous claim to fame had been as the designer of several major anti-tank guns and missiles for the Soviet armed forces. The Soviets evidently considered the weapon more of a defensive system rather than an offensive one, given the limited maneuvering capabilities of the Almaz OPS.

Because its primary mission was overhead reconnaissance, the OPS would have a low operational orbit (220 by 270 kilometers) and be oriented toward Earth's surface for long periods. The search and observation of targets on the ground thus posed complex demands on the guidance system. As per the original requirements, Chelomey's engineers designed a guidance system that would control the station continuously from the moment it separated from the launch vehicle to orbital decay many months later. What they emerged with was a "decentralized" system, with subsystems for orientation, stabilization, movement control of the center of mass of the vehicle, navigation, and programmed control of the on-board apparatus. The primary flight control system was based on an analog system because a digital device that was continuously operable for a year was not in existence in the Soviet Union at the time. Instead, the All-Union Scientific-Research Institute for Electromechanics (formerly NII-627) headed by Chief Designer Andronik G. Iosifyan developed a new low-power electromechanical stabilization system using a spherical ring flywheel with a large kinetic movement. Unlike conventional orientation systems, there was almost no propellant consumption for this device. Cosmonauts would be able to carry out rapid roll control at one degree per second to expand their field of view. Precision would be achieved by a system that corrected the gyroscopic orientation system with a Doppler signal from a radar instrument, which itself was part of the radar observation gear for the station. This gyroscopic orientation system was developed by the Scientific-Research Institute for Applied Mechanics (formerly NII-944) under Chief Designer Viktor I. Kuznetsov, one of the original members of Korolev's old Council of Chief Designers from the 1940s.

The control system had various modes of operation, including precise orientation and stabilization, restoration of orientation from a disoriented position, and the spinning of the station into "storage" position. Cosmonauts themselves could also manually orient the station when observing targets by putting the target in the cross-hairs of their optical sight with a turn of the control stick. As a result, the guidance system would allow all the optical instruments on board to inspect the selected target. Although analog computers were used on the overall station's guidance system, Chelomey's engineers designed a digital system based on the Argon-12A computer for the observation instrumentation, a first for a Soviet piloted space vehicle. The computer was developed by the All-Union Scientific-Research Institute for Digital Computer Technology.⁸⁹

The first version of the Almaz OPS was equipped with a large return apparatus (IIF74), which was similar to the LK-1 and LK-700 lunar spacecraft. Apart from its shape, the OPS return

89. Afanasyev. "Unknown Spacecraft": V Polyachenko and A. Tumanov. "From the History of Space Science. The Controllable 'Almaz'" (English title). *Aviatsiya i kosmonautika* no. 8 (August 1993): 41-43; I. Marinin. "AO Krasnogorsk Plant Named After S. A. Zverev" (English title). *Novosti kosmonautiki* 19 (September 9-22, 1996): 44-49; *Officially Never Disclosed*. Moscow Ostankino Television, First Channel Network. Moscow. November 26, 1994. 1105 GMT, Igor Tsarev. "A 'Diamond-Studded' Sky: Should the Military, Who Maintain They Have Stopped Preparing for 'Star Wars,' Be Trusted" (English title). *Trud*. September 28, 1993. p. 4; S. A. Zhitsov, ed., *Gosudarstvennyy kosmicheskyy nauchno-proirvodstvennyy tsentr imeni M. V. Khrushcheva* (Moscow. RUSSLIT, 1997). pp. 78-79. Christian Lardier. *L'Astronautique Sovietique* (Paris: Armand Colin, 1992). pp. 204-05; Dietrich Haeseler. "Original Almaz Space Station." *Spaceflight* 36 (October 1994): 342-44; B. A. Pokrovskiy. *Kosmos nachinayetsya na zemiye* (Moscow: Patriot, 1996). p. 405

apparatus had two striking similarities to MOL's Gemini-B: the Soviet vehicle was designed to have a hatch in the center of the heat shield for transfer to and from the station proper: and the spacecraft was designed for reuse on subsequent stations. Originally, it seems that Chelomey intended to launch the return apparatus and the OPS separately and assemble the two in orbit, but this plan was abandoned later in favor of launching the crew in Almaz on a Proton rocket. The return apparatus consisted of three sections: a conical crew capsule with a flat top shaped remarkably like the Apollo Command Module; a second longer cone with a sharper angle attached at the apex of the crew capsule; and a short, thin cylinder at the very forward end containing a powerful deorbit engine. The length of the return apparatus was 3.64 meters, and the base diameter was 2.79 meters.

On the OPS, the truncated spherical base of the return apparatus was fixed at the forward end of the station on the opposite end from the docking unit. The 4.9-ton module had three seats in its internal volume as well as control panels for operations during mission end. The longer cone section of the return apparatus was equipped with a set of attitude control thrusters for use prior to reentry, as well as the primary and backup parachutes. At launch, the entire OPS-return apparatus complex was topped off by a long thin escape tower equipped with two sets of solid-propellant rocket engines for emergency situations during passage through the lower atmosphere. Once in orbit, the crew would vacate their seats and remove the center seat to open a hatch at the base of the return apparatus and crawl into the small-diameter area in the Almaz OPS. There were evidently many engineers who believed that having a hatch in the middle of a heat shield—that is, the most stressed part of a spacecraft—was akin to suicide, but Chelomey was confident that this was a workable design. For return to Earth, the cosmonauts would secure themselves in the return apparatus, close the heat shield hatch, and undock from the station. After they fired the deorbit engine, the conical capsule would separate from the cylinder and brake into Earth's atmosphere. Independent flight was limited to about thirty hours. The return apparatus was capable of returning at least 360 kilograms of equipment, film, and other materials to Earth after a long-duration flight. It was designed to have a lifetime of five flights." Some of these missions would be as part of a future projected delivery vehicle to the Almaz station, named the Transport-SupplyShip, which was at a very early stage of planning in 1967. By this time, the first Almaz space station launch was set for sometime in 1968–69. The first cosmonaut training group for the Almaz station was established as early as September 1966, although crew training proved to be of a very preliminary nature through 1967."

The early Almaz station's design and capabilities were quite similar to the American MOL. This was partly attributable to the ancestry of both complexes. The Almaz OPS descent apparatus emerged from the LK-700 and LK-1 capsules, which were based to a great degree on Gemini. Similarly, MOL Gemini-B was simply an uprated Gemini. Chelomey clearly had access to information on MOL. During the 1960s, the Soviet government used to publish a classified weekly journal entitled *Raketno-kosmicheskaya tekhnika* (Rocket and Space Technology) containing abstracts of articles published in the open media in the West. In 1964 and 1965, the journal evidently published numerous articles on the MOL." While there is no clear evidence

90 Afanasyev, "Unknown Spacecraft". Polyachenko and Tumanov, "From the History of Space Science The Controllable 'Almaz'". Lardier, *L'Astronautique Soviétique*, p. 203; Nina Chugunova, "Chelomey's Cosmonauts Why There Are No Crews From NPO Mashinostroyeniya in Outer Space" (English title). *Ogonek* 4-5 (January 1993) 24-29; Haeseler, "Original Almaz Space Station."

91 There were a total of seven cosmonauts selected for the Almaz group on September 2, 1966: P. I. Belyayev, L. S. Demin, V. G. Lazarev, A. N. Matinchenko, G. S. Shonin, L. V. Vorobyev, and D. A. Zaykin. Belyayev, the only spaceflight veteran, was the commander of the group. See Vadim Y. Molchanov, "Soviet Manned Lunar Programs." *Quest* 2(4) (Winter 1993), 43; Kamanin, *Skrytiy kosmos 1964-66*, p. 374.

92 K. Lantratov, "Dmitriy Kozlov's 'Zvezda': Part III" (English title). *Novosti kosmonavtiki* 5 (February 24-March 9, 1997) 81-86.

to suggest that Chelomey took MOL plan wholesale, macro-level design characteristics of Almaz were probably influenced significantly by the American project.

. . . a Star . . .

As befits the story of any Soviet space project from the 1960s, the Soviet Union did not respond to a singular U.S. space project, such as MOL, with a singular response. Almaz, in fact, had a complementary military piloted project that, while a little more modest, was also a response to the MOL. When the Military-Industrial Commission approved the initial plans for the Almaz station in 1965, the first flight was expected in 1968. Motivated by concerns of having a Soviet crewed military presence in the intervening three years, the commission looked into other options. In early August 1965, Commission Chairman Smirnov signed an order to develop a military version of the 7K-OK Soyuz for missions involving visual and photographic reconnaissance, satellite inspection, the testing of early warning technologies, and the verification of the operation of weapons in orbit. The Central Committee and the Council of Ministers, in its decree of August 24, 1965, approved a timetable for the development of such a vehicle, officially named the *Zvezda* ("Star"). Coincidentally or not, by this time, OKB-1's Branch No. 3 in Kuybyshev under Deputy Chief Designer Kozlov had, on his own authority, completed the draft plan that fulfilled the government's requirements. After further discussions, on July 7, 1966, the Ministry of General Machine Building signed an order (no. 296ss) selecting Kozlov's branch as the lead developer of the *Zvezda* ship. Kozlov proposed a modification of the original 7K-OK Soyuz named the 7K-VI⁹³

In its original conception, the design of the 7K-VI was very similar to Korolev's 7K-OK. It had three major components arranged from the front to the aft: the living compartment, the descent apparatus, and the instrument-aggregate compartment. The first section would have carried a full complement of military instrumentation. By late 1966, Kozlov began to rethink this design, motivated by the two failures in the Soyuz precursor program, including the catastrophic launch failure in December 1966 when a military officer had been killed. To preclude such problems from occurring on his ship, Kozlov prepared a new design for the 7K-VI, which departed significantly from the 7K-OK. In the new design, the descent apparatus and the living compartment switched places. This meant that just as in Almaz and MOL, there would be a hatch in the middle of the crew compartment's heat shield to allow cosmonauts to move into the main experiment module of the ship. The new ship had a heavier mass of just over six and a half tons and could fly thirty-day-long missions in Earth orbit with two crewmembers. The heavier ship required an updated version of the basic 11A511 Soyuz launcher, called the 11A511M. The Ministry of Defense found the new design worth pursuing, and in a governmental resolution on July 21, 1967, set a formal timetable for the first launch, targeted for 1968. The system would reach operational status a year later."

As with the early Almaz station, the 7K-VI was equipped with a weapon designed by Chief Designer Nudelman's Design Bureau of Precision Machine Building. The complement consisted of a single rapid-firing gun modified for use in vacuum, mounted on the descent apparatus. Cosmonauts would be able to aim the gun by maneuvering the entire spacecraft using a special visor. Skeptics believed that pilots would not be able to aim the gun: they also believed that the recoil from gunfire would send the entire ship into a spin. To eliminate such problems, Kozlov's engineers built a dynamic test stand at Branch No. 3 in mid-1967, consisting of the descent

93 Lantratov "Dmitriy Kozlov's 'Zvezda' Part II" Its production index was 11F73

94 *Ibid* Initially Kozlov wanted to have one crewmember aboard the 7K-VI to compensate for the heavier mass but the Ministry of Defense believed that one cosmonaut would not be able to accomplish all the planned work in orbit

apparatus, an optical visor, control systems, and seats set on a platform resting on an air cushion. Subsequent tests dispelled any doubts about the capability of both the pilot and the ship during a shooting match. As in the Almaz OPS, Zvezda's gun was insurance against the possibility that American satellites on anti-satellite or inspection flights would engage the Soviet spaceship.

The descent apparatus, although shaped like the basic Soyuz version, had two seats in it, but facing in slightly different directions, like a "v"-shaped pattern. The hatch was positioned underneath the seats. Tests at the time verified the hatch-in-the-heat-shield design, which was the subject of much concern, both in the Zvezda and Almaz programs. The living compartment of the 7K-VI contained the primary reconnaissance instrument, the OSK-4 optical visor and camera, installed on a side porthole. The cosmonaut would sit in a saddle, looking somewhat like a cyclist, and use a visor to observe and photograph Earth's surface. Cosmonauts could also mount other instruments on the porthole, including the *Svinets* device, a throw-over from the abandoned Voskhod 3 flight, for observing ballistic missile launches. They would also use a long mast extending from the outside of the living compartment for electronic intelligence and the detection of any approaching enemy spacecraft.

One unusual attribute that set the 7K-VI apart from any previous piloted vehicle was its power source. Kozlov dispensed with solar arrays, believing them to be a potential source of problems (confirmed on Soyuz 1). He proposed the use of two radio-isotope generators, which would convert heat produced by the radioactive decay of plutonium into the large amount of electricity required for the extensive instrument complement aboard the vehicle. To preclude accidents upon reentry, the generators were encased in landing capsules capable of surviving reentry. Once they were recovered, engineers would reuse them for subsequent missions.

A final design objective of the 7K-VI spaceship was to serve as a transport ship for future crews to the Almaz space station, much like the terminated 7K-TK from Kozlov's early plans for a military space vehicle. Branch No. 3 engineers looked into the possibility of installing a docking unit at the forward end of Zvezda to allow it to dock with the Almaz station, thus establishing quite a formidable military space complex in Earth orbit, designated imaginatively the *11F711*.⁹⁵

Given the several years of work on the abandoned Soyuz-R variant, progress on the 7K-VI Zvezda program was swift. By mid-1967, Kozlov had defended a revised draft plan for the ship and its launch vehicles, based on a tactical-technical requirement for the spaceship issued by the Ministry of Defense in March 1967. His engineers had also transferred all technical



Dmitriy Kozlov was the First Deputy Chief Designer at TsKBEM under Vasily Mishin. He headed the Korolev design bureau's Branch No. 3 in Kuybyshev starting in 1959. As chief of the branch, which later became independent in 1974, Kozlov oversaw the development of robotic and piloted reconnaissance spacecraft for the USSR Ministry of Defense. Kozlov remains the head of his organization to this day, remaining one of the last chief designers from the Korolev era who are still active in the Russian space program. His design bureau continues to build almost all of Russia's photo-reconnaissance spacecraft (files of Peter Gorin)

documentation to the Progress Plant for the manufacture of the first models. The Air Force Commander-in-Chief's Aide for Space Matters Lt. General Kamanin established the first 7K-VI cosmonaut training group in September 1966, comprising six cosmonauts headed by the veteran Pavel R. Popovich.⁹⁶ Through 1967, Popovich spent much time in Kuybyshev training on the ship and testing out its rapid-fire gun in simulators. In addition to career cosmonauts, the Ministry of Defense was also intent on including scientists from its various research institutes. Three researchers from NII-2 of the Air Defense Forces joined the team at the Cosmonaut Training Center on April 12, 1967. NII-2 was the leading institute developing strategy for anti-satellite operations on automated Soviet satellites, such as the IS system.⁹⁷

Schedules for the program were also set at that time. On August 31, 1967, Military-Industrial Commission Deputy Chairman Georgiy N. Pashkov chaired a meeting to discuss the course of the Zvezda project, calling it a program of "extraordinary importance."⁹⁸ Kozlov optimistically predicted that the first automated flight would take place in the second half of 1968, although Progress Plant Director A. Ya. Linkov believed 1969 was more realistic.

That military piloted operations were of great concern not only to the Ministry of Defense but also to the Soviet leadership was underlined by a meeting of the Council of Defense on July 15, 1967. The council, a shadowy body attached to the Politburo, was the supreme arbiter for all defense issues in the Soviet Union. At the meeting, Brezhnev and Kosygin expressed dissatisfaction with delays in the Soviet piloted space program and ordered an expansion of military operations in space. The breadth of Soviet plans for the late 1960s and early 1970s was astonishing. In a diary entry for September 16, 1967, Lt. General Kamanin summarized his notes on the next eight-year plan for Soviet space operations, covering 1968 to 1975. According to his calculations, the military would need twenty *Almaz* space stations and fifty *Zvezda* ships, in addition to 400 "transport ships," presumably the *Soyuz*. The total annual launch rate of crewed ships would reach forty-eight.⁹⁹

Soviet plans for the military piloted dominance of space were not limited to conventional systems such as *Almaz* and *Zvezda*. As more evidence of an almost unprecedented military buildup in space, the USSR had a third, much more ambitious, piloted space project approved in the mid-1960s. Since the beginning of the space era, a host of Soviet aviation designers, such

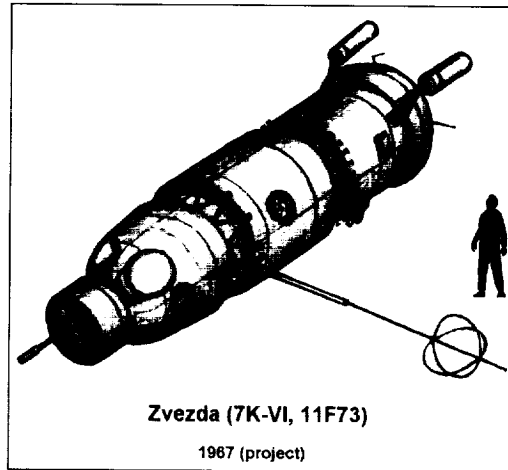

This is a drawing of Dmitriy Kozlov's 7K-VI piloted reconnaissance spacecraft developed in the 1960s. Although the spacecraft design was based on the original Soyuz spacecraft, there were major differences in the layout of the main modules of the vehicles.
(copyright Peter Gorin)

96. N. Kamanin, "A Goal Worth Working for," no. 44. The six cosmonauts were Yu. P. Artyukhin, B. N. Belousev, A. A. Gubarev, V. I. Gulyayev, G. M. Kolesnikov, and P. R. Popovich. They were later joined by A. F. Voronov and D. A. Zaykin.

97. These three cosmonauts were V. B. Alekseyev, M. N. Burdayev, and N. S. Porvatkin. See V. Semenov, I. Marinin, and S. Shamsutdinov, *Iz istorii kosmonautiki: vypusk I: nabory v otryady kosmonavtov i astronautov* (Moscow: AO Videokosmos, 1995), pp. 10, 12.

98. Lantratov, "Dmitriy Kozlov's 'Zvezda': Part III."

99. *Ibid.*

as Tsybin, Myasishchev, and Chelomey, had doggedly pursued a dream of building a reusable spaceplane, one that could eventually fly from airport into space and land back on a runway. Thwarted mostly by the winds of political change, none of their three projects ever got off the ground. By 1965, the Soviet Air Force gave it yet another try, in a project that would eventually span thirteen long years.

... and a Spiral

General Designer Vladimir N. Chelomey's Raketoplan project, consisting of the R-1 and R-2 spaceplanes, had died an ignominious death around 1965—a result of the technological limitations and the political exigencies of the period. At the same time, the primary *d'être* for the project, the U.S. Air Force's X-20A Dyna-Soar, had long been consigned to history. For the immediate future, there were no serious plans by the U.S. armed forces to pursue the creation of such vehicles. Only some test vehicles were flown. Under a joint NASA-Air Force program, lifting bodies such as the M2-F2 and HL-10 were tested at NASA's Flight Research Center (later the Dryden Flight Research Center) at the Rogers Dry Lake in California.¹⁰⁰ The lack of U.S. support for spaceplanes did not deter the Soviets. Unlike almost any other Soviet piloted space project of the Cold War era, something prompted the Soviets to push the development of a piloted spaceplane well after the Americans had abandoned such hopes. Historical precedent suggests two reasons: either the Soviets believed that secretly the United States was developing such a vehicle, or it was insurance against the possibility of the United States developing such a vehicle in the future. Both rationales, of course, hinge critically on the assumption that in their Cold War-era space projects, the Soviet Union and the United States were doing things in a parallel and responsive manner instead out of a unilateral need to do such things. Whether this is a hypothesis that will hold up to historical scrutiny remains to be seen. The record from the former USSR still remains vastly incomplete.

In the early 1960s, the Air Force contracted two aviation industry design bureaus. OKB-156 headed by Andrey A. Tupolev and OKB-155 headed by Artem I. Mikoyan, to propose elements of an Integrated reusable aerospace transportation system.¹⁰¹ Little is known about the Tupolev proposal. Scientific research on lifting bodies had apparently begun during the late 1950s at the famous N. Ye. Zhukovskiy Central Aerohydrodynamics Institute (TsAGI). Based on this research, OKB-156 had initiated work in the late 1950s and the early 1960s on a suborbital lifting body using "hot" construction—that is, frames using heat-resistant alloys without special thermal shielding. In the 1960s, General Designer Tupolev apparently designed and built a full-scale hypersonic vehicle capable of Mach 2 to 5 to verify ground research on developing a winged space glider. Research conducted in cooperation with the famous M. M. Gromov Flight-Research Institute helped engineers experimentally verify data already obtained from wind tunnels on such parameters as aerodynamic quality, characteristics of longitudinal and lateral static stability, and balance at different angles of attack during reentry. The engineers discovered that for a winged hypersonic vehicle with a relatively large stern area, air resistance could reduce aerodynamic quality by 30 to 40 percent. The overall research helped identify changes in further research on the basic layout of a reusable spaceplane.¹⁰²

100. Richard P. Hallion. *On The Frontier. Flight Research at Dryden, 1946-1981* (Washington, DC: NASA Special Publication (SP)-4303, 1984). pp. 147-72

101. Mikhail Rebrov, "The Moor Did Its Business . . . The Fate of 'Buran,' as Dramatic as Our Lives" (English title), *Krasnaya zvezda*, November 29, 1997. p. 5; Kamanin, *Skrytiy kosmos 1964-1966*, p. 262

102. K. K. Vasilchenko, et al., eds., *letnyye issledovaniya i ispytaniya: fragmenty istorii i sovremennoye sostoyaniye nauchno-tekhnicheskoy sbornik* (Moscow: Mashinostroyeniye, 1993), p. 55; *TsAGI-Osnovnyye etapy nauchnoy deyateinostr. 1968-1993* (Moscow: Nauka, 1996), p. 155.

This early work was to lead to the development of a complete two-stage reusable space transportation system. The first stage would be a hypersonic carrier aircraft, and the second stage a small plane for short jaunts into space. Between 1961 and 1966, Tupolev's engineers apparently built a small automated prototype of the winged space launcher designated "product 130." Although details still remain classified, the aircraft was developed on the basis of the Tu-95 bomber as part of a large-scale study of hypersonic flying vehicles in the 1950s and 1960s. Work on the 130 was to have led to the creation of a rocket-propelled spaceplane named Zvezda, which would have been launched into orbit by some modification of the UR-200 ICBM. The launch system for the 130 would have been similar to the one used on the American B-52A aircraft for "drop-launching" the X-15 rocket-plane." Unlike his competitor Mikoyan, Tupolev apparently had a "cool" attitude toward the spaceplane program in general. By 1966, whatever work had been accomplished at OKB-156 was terminated. Instead of a unilateral spaceplane program, it seems that Tupolev joined up with Mikoyan for a cooperative project, which proved to be the most famous Soviet spaceplane of the early Soviet space era.

General Designer Mikoyan, the head of the MiG design bureau, had had a long interest in such topics. He had publicly expressed an interest in space as early as 1962, when in an article in the Soviet military newspaper *Krasnaya zvezda (Red Star)*, he described a spaceplane design:

*The spaceplane is an intermediate link between aviation and rocket technologies a combination of a ballistic rocket and airplane viewed as a whole the spaceplane will have the general outlines of a modern airplane with elements of a spaceship The space plane will be launched as is a ballistic missile and will fly at altitudes of 100 to 200 km After acceleration to a speed of 79 km/sec the spaceplane will follow a ballistic trajectory with deceleration*¹

It seems that Mikoyan had begun exploratory studies on such topics in the early 1960s, possibly derived from Chief Designer Tsybin's research on the abandoned PKA spaceplane from the late 1950s. It would be 1965, however, before Mikoyan initiated any productive work on the spaceplane project.¹⁰³ At the time, Mikoyan inherited a secondary source of information to accelerate his efforts. When the new Brezhnev administration terminated Chelomey's R-1/R-2 spaceplane project in 1965, much of the database was transferred to Mikoyan's Moscow-based OKB-155, along with a number of engineers who had worked on Chelomey's project. This information proved invaluable for Mikoyan's designers to quickly advance from a research to an experimental stage in the development of a new aerospace system." Chelomey, of course, had inherited his spaceplane research from Myasishchev's work on the promising but ultimately abandoned M-48 design. Mikoyan also was favorably placed to take advantage of the massive research work at the prestigious TsAGI during the early 1960s on various Chelomey and Tupolev research projects. In the topsy-turvy world of space politics, Mikoyan had thus inherited the

103 Bill Cunston *The Osprey Encyclopedia of Russian Aircraft 1875-1995* (London: Osprey Aerospace 1996) p. 435. E-mail correspondence: Mark Hillyer to the author, April 30, 1998.

104 A. Mikoyan "Future Aerospace Technology" (English title) *Krasnaya zvezda* January 9, 1962, pp. 2-3, quoted in *Soviet Space Programs: Organization, Plans, Goals, and International Implications*, prepared for the Committee on Aeronautical and Space Sciences, U.S. Senate, 87th Cong., 2d sess. (Washington, DC: U.S. Government Printing Office, May 1962), p. 333.

105 Cleb E. Lozino Lozinskiy and Vladimir P. Plokhikh "Reusable Space Systems and International Cooperation" *Aerospace America* (June 1990), 37-40; Afanasyev "Unknown Spacecraft."

106 Interview: Serbert Aleksandrovich Yefremov with the author, March 3, 1997; Anatoly Kirpil and Olga Okara "Designer of Space Planes: Vladimir Chelomey Dreamed of Creating a Space Fleet of Rocket Planes" (English title) *Nezavisimaya gazeta*, July 5, 1994, p. 6.

complete database for most prior spaceplane research in the Soviet Union. It put him in an extremely favorable position to move quickly on the project.

Less than two years after the cancellation of the X-20 Dyna-Soar, on July 30, 1965, the Ministry of Aviation Industry approved work on a new spaceplane project named *Spiral*.¹⁰⁷ The head of the *Spiral* project at OKB-155 was one of Mikoyan's principal deputies. Chief Designer Gleb Ye. Lozino-Lozinskiy, a fifty-five-year-old engineer who had played a tremendously significant role in the development of numerous MiG fighters. During Khrushchev's downsizing of aviation in favor of rockets, Lozino-Lozinskiy had stood up to the Soviet leader's tirades against airplanes, suggesting that "in spite of all the enthusiasm with regard to rockets, one should not forget the little wings. They are still of use to us.": "As chief designer of the *Spiral* project, Lozino-Lozinskiy signed off on the preliminary design of the system on June 29, 1966, just a year after work had begun." To expand the work profiles at his design bureau, Mikoyan subsequently established a branch of OKB-155 (by this time renamed MMZ Zenit) dedicated specifically to space themes at the premises of the Dubna Machine Building Plant near Moscow. Coincidentally, it was at this same plant that former Chief Designer Tsybin had directed his work on spaceplanes in the late 1950s. Mikoyan's new Dubna branch, created in 1966, had its own design bureau, headed by Yuriy D. Blokhin, who supervised all of Lozino-Lozinskiy's work on *Spiral*. A third man, Petr A. Shuster, served as the chief of the branch."¹⁰⁸

The primary goal of *Spiral* was piloted spaceborne reconnaissance, satellite inspection, and anti-satellite operations. To do this, engineers needed to create a system capable of operating within very short lead times, one that was reusable, and one that could be launched from a variety of locations. Thus, Mikoyan dispensed with the idea of launching the spaceplane on conventional rocket boosters and, in fact, adopted a design that was in some ways very similar to the Chelomey and Tupolev concepts—that is, launching the spaceplane into orbit from a mother aircraft. Rummaging through the extensive database on spaceplane research available to them, Mikoyan's engineers firmly believed that this would be the most efficient option. Early analyses showed that with an air-launched system, effective payload increased by about 9 percent over standard ballistic models, while the associated costs were projected to be three to three and a half times lower for launching one kilogram of payload into orbit over conventional single-use launch designs. There were also operational advantages. Soviet engineers believed that an air-launched system would afford them all-weather and twenty-four-hour launch capability. Space visionaries, of course, continue to debate to this day the advantages and disadvantages of such systems for delivering payloads to orbit, but in the heyday of the

107. A Central Committee and Council of Ministries decree on *Spiral* was issued in late 1965.

108. Col. M. Rebrov, "The Revolutions of 'Spiral': A Biography and Portrait of the Chief Designer of the Buran Space Plane" (English title), *Krasnaya zvezda*, July 31, 1991, p. 4

109. Vyecheslav Kazmin, "The 'Quiet' Tragedy of EPOS" (English title), *Krylya rodiny* no. 11 (November 1990): 25–26

110. *Ibid* The Dubna Machine Building Plant (MZ Dubna) was formerly known as Plant No. 256. P. V. Tsybin's OKB-256 moved here on April 25, 1956. After OKB-256 was dissolved on October 1, 1959, the plant was subordinated to OKB-2-155 headed by Chief Designer A. Ya. Berezhnyak. OKB-2-155 was a branch of the Mikoyan design bureau at the time and had produced a number of short-range cruise missiles after its establishment on October 12, 1951. When OKB-2-155 was separated from its parent entity in 1966, part or all of the facilities of the Dubna Machine Building Plant remained subordinate to the Mikoyan design bureau. It was here that OKB-155's Space Branch was established. From 1966 on, OKB-2-155 was known as the Raduga Machine Building Design Bureau (MKB Raduga). There is evidence to suggest that MKB Raduga cooperated with OKB-155's Space Branch on the *Spiral* project. See Vladimir Nikolayevich Trusov, "45! MKB 'Raduga'" (English title), *Vestnik vozdushnogo flota* (1997): 16–18; Stepan Mikoyan, "'Molniya' From 'Spiral' to MAKS" (English title), *Vestnik vozdushnogo flota* (1997): 60; Lardier, *L'Astronautique Soviétique*, p. 100; Piotr Butowski, "Steps Towards 'Blackjack'." *Air Enthusiast* 73 (January–February 1998): 36–49, E-mail correspondence, Mark Hillyer to the author, March 29, 1998.

mid-1960s, to a generation of old-school aeronautical engineers such as Mikoyan and Lozino-Lozinskiy, there was no question that air-launched spacecraft were the wave of the future.

Lozino-Lozinskiy's 114.8-ton Spiral system was a two-stage system consisting of the reusable Hypersonic Booster-Aircraft ("product 50-50") and a two-stage payload. The payload consisted of an expendable two-stage booster rocket and the Orbital Aircraft ("product 50"). The engineers proposed two near-identical Spiral systems—a primary and a secondary model, each differentiated only by the choice of propellants:

Component	Primary Model Propellants	Secondary Model Propellants
Hypersonic Booster-Aircraft	Liquid hydrogen	Kerosene
Booster rocket	LOX-liquid hydrogen	LOX-kerosene
Orbital Aircraft	Nitrogen tetroxide-unsymmetrical dimethyl hydrazine	Nitrogen tetroxide-unsymmetrical dimethyl hydrazine

The Hypersonic Booster-Aircraft (the 205) was a large tailless aircraft built somewhat like a "flying wing," with sweptback wings and vertical stabilizer surfaces on the wing tips. It was equipped with four multimode air-breathing turbojet engines operating on kerosene (on the secondary variant) or on liquid hydrogen (on the primary variant). The aircraft's turbojets were under the main long fuselage and had a common, regulated supersonic air intake. The actual orbital payload was fixed on top of the aircraft to a pylon, with its forward and rear ends covered by fairings. The Hypersonic Booster-Aircraft had a total length of thirty-nine meters, a wingspan of sixteen and a half meters, and a mass of fifty-two tons (primary version) or seventy-two tons (second variant).¹¹ One of the more imposing technical challenges was the development of a hydrogen-fueled carrier aircraft. Much of this research was carried out at TsAGI near Moscow in cooperation with the Institute of Theoretical and Applied Mechanics of the Academy of Sciences, based in Novosibirsk, Siberia. Beginning in 1967, Institute Director Academician Vladimir V. Struninskiy was instrumental in laying the foundation for this work, which was not only in support of the Spiral carrier aircraft but also for future transport and bomber aircraft.¹²

The payloads—the two-stage rocket and the Orbital Aircraft—were attached on top of the Hypersonic Booster-Aircraft's fuselage from the rear, to two-thirds of the way toward the front of the carrier aircraft. The booster rocket was a classical cylindrical rocket with a mass of 52.3–52.5 tons consisting of two stages, both fueled on either liquid oxygen (LOX)–kerosene or LOX–liquid hydrogen. Unconfirmed reports suggest that this rocket, designed to accelerate the Orbital Aircraft into orbit, may have been a contribution from Korolev's OKB-1. Other contradictory evidence suggests that Lozino-Lozinskiy may have considered using one of Chelomey's ICBMs, the UR-100, for the role. If indeed the UR-100 was actually under consideration for the Spiral system, Mikoyan and Lozino-Lozinskiy must have factored in a significant amount of redesign to accommodate the new propellant combinations because the UR-100 used storable hypergolic combinations. In the Spiral conception, the

111. Afanasyev, "Unknown Spacecraft", Lardier, *L'Astronautique Soviétique*, p. 248; E-mail correspondence. Igor Afanasyev to the author, December 6, 1997.

112. Another participant in this program was OKB-165 headed by General Designer A. M. Lyulka. See also Lardier, *L'Astronautique Soviétique*, p. 175; G. P. Svishchev, ed., *Aviatsiya entsiklopediya* (Moscow: Bolshaya Rossiyskaya entsiklopediya, 1994), p. 546.

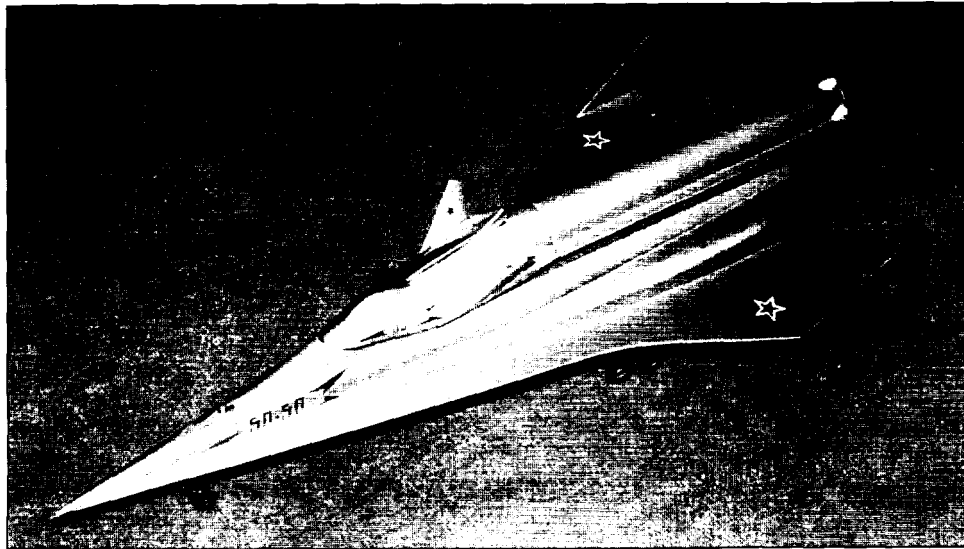

This is a model of the complete Spiral system on display. The high-speed 50-50 carrier aircraft would have returned to an airport after accelerating its combined payload to a velocity of about Mach 5-6. The actual Spiral spaceplane is mounted on top of the carrier's fuselage backed by a two-stage cylindrical rocket at its base. (files of Asif Siddiqi)

booster rocket would have a first-stage thrust of 100 tons, a little more than the eighty tons on the UR-100 ICBM. Second-stage thrust would be twenty-five tons."

The main component of the Spiral system was the Orbital Aircraft (the 105). The relatively small vehicle was built on a triangular base and had wings swept back at fifty-five degrees. The vehicle had a length of eight meters and a wingspan of just under seven and three-quarters meters. Four meters of the wingspan covered the width of the fuselage. The mass of the ship was only 10.3-10.5 tons. The useful payload of the ship would be two tons. The shapes of the lifting body, the wing, and the rear fin were designed for optimum performance in any given flight regime and potential shell temperatures as a result of frictional heating. The rear fin was swept back at sixty degrees and was attached at the rear of the spacecraft on top of the vehicle's turbojet engine. Additional airbrakes were hinged on the upper surface of the fuselage. The wings themselves could be rotated to a vertical position during orbital injection and the initial portion of reentry to reduce thermal stresses. In the subsequent gliding phase through the atmosphere, these panels would be folded out to provide maximum surface area and better lift-drag ratios.

The single pilot's cockpit consisted of a pressurized metallic capsule lined with insulating material. In case of an emergency in orbit that might prevent the entire vehicle from deorbiting, the pilot could detach the headlight-shaped capsule from the main fuselage and use its own engine to reenter and land by parachute. The rear part of the cockpit thus had its own self-contained heat shield. To facilitate ejection, the capsule was mounted on two rails anchored to the fuselage structure with a pyrotechnic ejection device. Internal pressure and temperature would be maintained at 760 mm Hg and ten to fifty degrees Centigrade, respectively. While the pilot

113. Kazmin. "The 'Quiet' Tragedy of EPOS": Afanasyev, "Unknown Spacecraft". *L'Astronautique Soviétique* p. 175; Afanasyev correspondence, December 6, 1997.

could control most operations manually, including the elevons and rudders as well as the main turbojet engine, there was an on-board computer for navigation and automatic flight control.

For landing, instead of wheels. Lozino-Lozinskiy chose to use four skids retracting via compressed air stored at the front of the struts. With a high angle of attack, the ship would land on the rear skids first, before tipping forward onto the forward ones. Each skid strut was equipped with special shock absorbers.

For propulsion, the Orbital Aircraft had three different sets of engines. The primary engine for maneuvering in orbit and deorbiting was a one-and-a-half-ton-thrust rocket engine positioned at the rear of the fuselage. In addition to the main thrust chamber, the engine also had two auxiliary combustion chambers at forty kilograms each for use in case of primary engine failure. The propellants for the engine, unsymmetrical dimethyl hydrazine and nitrogen tetroxide, were carried in tanks positioned at the fuselage's center, near the ship's center of gravity. A second set of engines with an independent feed system would be used for attitude control in both space and the atmosphere. It consisted of six engines at sixteen kilograms thrust and ten engines at one kilogram thrust. The higher powered ones were the primary means of controlling pitch, yaw, and roll, while the lower powered units were for precise orbital stabilization. The final propulsion unit on the Orbital Aircraft was the powerful RD-36-35K turbojet engine created by the Rybinsk Design Bureau of Engine Building (formerly OKB-36) under Chief Designer Petr A. Kolesov, the famous aviation engine designer who had up to that point developed jet engines for Tupolev, Sukhoy, and Yakovlev. Rated at two-ton thrust, the kerosene engine could be used both at takeoff for test flights to reach Mach 0.8 and at landing.

As in the previous Soviet spaceplane programs, much of the research and development effort surrounding Spiral was focused on the development of reusable thermal protection for the spacecraft. For high-speed aircraft of the period, the Soviets were moving slowly from aluminum and aluminum alloys to titanium alloys and eventually to beryllium and niobium alloys. In creating the Orbital Aircraft, the engineers designed the vehicle in such a manner as to compensate for thermal stresses not by a resilient heat shield, but rather by its aerodynamic design. Tests showed that with a special heat shielding screen, the maximum temperature at stressful points, such as the front of the fuselage, the edges of the wings, and the tail, did not exceed 1,500 degrees Centigrade. Consequently, Lozino-Lozinskiy's engineers used titanium alloys and in some places aluminum alloys without any expensive coatings, such as tiles. The heat "screen" itself was not solid, but composed of a set of sheets, much like a fish's scales, suspended on ceramic bearings. Given deviations in temperature, these scales automatically changed shape while preserving the stability of the shield's relative position to the main body of the craft."

Each flight of the Spiral system would begin with the use of a "launch truck" to boost the stack into the sky. In the case of the carrier aircraft using kerosene, the Hypersonic Booster-Aircraft was to take the complex to Mach 5.5-6 hypersonic velocities until the Orbital Aircraft with its two-stage booster separated at an altitude of twenty-eight to thirty kilometers. In using the hydrogen carrier variant, the separation was to occur at twenty-two to twenty-four kilometers altitude and at Mach 4. The two-stage booster would then come into operation and accelerate the vehicle to near-orbital velocity. Burn times would vary between 387.2 (liquid hydrogen) to 281.5 seconds (kerosene), depending on the propellant combination used. Then the Orbital Aircraft's own engine would kick in to inject the spaceplane into a low-Earth orbit at approximately 130 by 150 kilometers altitude. Orbital inclination would vary between forty-five and 135 degrees. The carrier aircraft would then flew back to its originating airport, ready for another flight.

114 Kazmin "The Quiet Tragedy of EPOS" Afanasyev. "Unknown Spacecraft" R. A. Belyakov and J. Marmain. *Mid Fifty Years of Secret Aircraft Design* (Annapolis MD Naval Institute Press 1992), pp 417-21

The flight of the Orbital Aircraft was short in duration, geared to its specific missions of interception, inspection, or reconnaissance. During the course of its two or three orbits in flight, the pilot could effectively change altitude and inclination of the orbit. After accomplishing its primary goal, the aircraft could dive into the atmosphere at a very high angle of attack (up to fifty-three degrees) with its wings folded at the standard forty-five degrees to the vertical and drop to hypersonic speed. When folded during reentry, the wings would remain in an aerodynamic "shadow," significantly reducing thermal stresses on critical areas while also improving stability. The spaceship was designed to have a 1,500- to 1,800-kilometer cross-range maneuver capability, allowing it much flexibility in choosing landing sites. After further reductions in speed, the pilot would unfold the spaceplane's wings to a near-horizontal position (ninety-five degrees to the vertical), glide down, and land at the chosen airport on its skids. In case the pilot was unable to land on the first pass over the runway, he would fire up the turbojet engine to steer the vehicle back for another try, at a landing speed of about 250 kilometers per hour."¹⁵

The Spiral project, as proposed in 1965–66, was to be performed in four distinct phases. During the first stage, MMZ Zenit was to build a suborbital analog of the Orbital Aircraft with a rocket engine for launch from a variant of the Tu-95 bomber named the Tu-95KM, apparently derived from the earlier Tupolev studies for the "product 130." The purpose of such tests was to evaluate the basic aerodynamic and power performance characteristics of the actual Orbital Aircraft in conditions close to spaceflight (altitudes of up to 120 kilometers and speeds up to Mach 6–8), as well as reentry into the atmosphere. Lozino-Lozinskiy planned to build three analogs, with subsonic flights beginning in 1967 and supersonic and hypersonic flights starting a year later.

In the second stage, engineers were to design and build the Experimental Piloted Orbital Aircraft (EPOS) for further improvement of design and flight characteristics of the Orbital Aircraft. The two vehicles were to be externally identical, differing only in some internal systems. The launch of the EPOS was planned on a standard Soyuz-type 11A511 booster. When Korolev and Lozino-Lozinskiy first discussed the use of an R-7–derived booster for use in the Spiral program, Korolev apparently pushed the idea hard. One of Lozino-Lozinskiy's deputies remembered later that Korolev's motivations for offering the Soyuz rocket for the Spiral program was "so he could get a big order for R-7's to make them cheaper."¹⁶ After launch by the Soyuz booster, the spaceplane was to enter a 150- by 160-kilometer orbit with a fifty-one-degree inclination, make two to three orbits, and then perform a reentry and landing nearly identical to that planned for the Orbital Aircraft. According to the initial plan, MMZ Zenit was to build four models of the EPOS for automated orbital missions beginning in 1969 and piloted missions the year after.

The third stage was to focus on the creation of the Hypersonic Booster-Aircraft, probably contracted out to Tupolev's OKB-156. The work on the Hypersonic Booster-Airplane was to begin with the creation of four models of the kerosene variant by 1970. After further experimental testing at hypersonic speeds, Tupolev's engineers were to proceed to the construction of the more complex hydrogen variant, with flight tests beginning in 1972. Four models were slated for production in the initial plan.

The final stage of the Spiral program included integrated testing of the entire system, with the Hypersonic Booster-Aircraft, the two-stage booster rocket, and the Orbital Aircraft. Automated

¹⁵ Afanasyev, "Unknown Spacecraft"; Kazmin, "The 'Quiet' Tragedy of EPOS"; Lozino-Lozinskiy and Plokhikh, "Reusable Space Systems and International Cooperation"; Andrey Batashev, "Steep Turns of the Spiral: A Quarter-Century Did Not Suffice for Implementing the Project Created by the 'Father' of the Soviet Shuttle" (English title). *Trud*, June 30, 1994, p. 4; Afanasyev correspondence, December 6, 1997.

¹⁶ James Harford, *Korolev: How One Man Masterminded the Soviet Drive to Beat America to the Moon* (New York: John Wiley & Sons, 1997), p. 275.

flights in the kerosene variant were to begin in 1972, leading to full-scale testing of a piloted variant using liquid hydrogen in 1973. It was, in all senses, a long-range program and one not tied to meeting unrealistic deadlines arising from a necessity to respond to a similar U.S. project.

The Spiral project was huge, much larger than any of the previous spaceplane programs in the Soviet Union, certainly rivaling and perhaps exceeding the amount of effort the U.S. Air Force had invested in the Dyna-Soar program. The rich historical legacy of spaceplane research in the USSR, leading all the way back to the Sanger-Bredt studies in the late 1940s, served as a springboard for the new project. Apart from MMZ Zenit, another important player in the program was the famous TsAGI, whose director ironically at the time of Spiral's birth was former General Designer Myasishchev. Earlier, during 1961-64, Myasishchev had initiated a program under the codename *Tayga* to study complex phenomena associated with hypersonic flight, inspired apparently by concurrent American projects such as PRIME. Throughout 1965-69, TsAGI scientists conducted extensive tests in wind tunnels to refine the design of the Spiral Orbital Aircraft. Here, scientists used the MK-105 stand for determining the architecture of the complex guidance system for the spaceplane. The institute also conducted tests in support of Spiral in specially re-equipped L-18 flying laboratories. In 1967, a team of TsAGI scientists also began research on determining the layout for a single-stage-to-orbit aerospace system using hydrogen engines. Engineers studied the possibility of extrapolating the results of the Spiral program from a one-person spaceplane to a multicrewed orbital transport vehicle. Remarkably, the Orbital Aircraft's excellent lift-drag ratio and thermal characteristics were retained in the large model.

Based on the research at TsAGI, especially on the *Tayga* program, three institutions—the M. M. Gromov Flight-Research Institute at Zhukovskiy, Plant No. 166 at Omsk, and MMZ Zenit—cooperated in the design of a series of test beds to prove the basic technologies of the new Spiral spaceplane program. Under the name Unpiloted Orbital Rocket-Glider (BOR), the engineers set out to study the various critical points in a spaceplane's trajectory during both suborbital and orbital flights. The early BOR vehicles came in three different variants, scale models of the EPOS at one-half and one-third size for launch on suborbital ballistic trajectories. BOR-1, BOR-2, and BOR-3 were to be used primarily to study stability and controllability characteristics at supersonic and subsonic speeds and also to evaluate the performance of thermal shielding to be used on the EPOS.¹¹⁷

Some cosmonauts also got into the act. As early as December 1965, three pilots, including veteran cosmonaut Titov, began preliminary studies in connection with the Spiral project. They performed more intensive flight training than was usual for other cosmonauts at the time, first flying MiG-17s and then moving on to MiG-21s in 1966. By the following year, they were flying fighter-interceptor aircraft of all types currently in operation with the Soviet Air Force.¹¹⁸ Perhaps not coincidentally, fifteen Air Force officers were at the time completing their graduate degree work at the prestigious N. Ye. Zhukovskiy Military-Air Engineering Academy in Moscow. At Korolev's behest, the entire group, which included most of the 1960 and 1962 cosmonaut enrollments, were studying the development of a single-seat reusable spaceplane.¹¹⁹ Among their study duties was to analyze the performance characteristics of the defunct Dyna-Soar spacecraft. The cosmonauts later named their own project "Buran-68," which as it turned out differed

¹¹⁷ E-mail correspondence Igor Afanasyev to the author December 11, 1997. Kazmin, "The Quiet Tragedy of EPOS," *TsAGI Osnovnyye etapy nauchnoy deyatel'nosti 1968-1993*, pp. 156-244.

¹¹⁸ G. Titov, "This is Needed for All of Us" (English title) *Aviatsiya i kosmonavtika* no. 4 (April 1993), 2-3. The other two cosmonauts training with Titov were A. V. Filipchenko and A. P. Kuklin, both rookies. See also Kamanin, *Skrytiy kosmos 1964-1966*, pp. 295-306, 347.

¹¹⁹ S. M. Belotserkovskiy, *Gibel Gagarina fakty i domysly* (Moscow: Mashinostroyeniya, 1992), p. 19. The fifteen cosmonauts were V. F. Bykovskiy, Yu. A. Gagarin, V. V. Gorbalko, Ye. V. Khrunov, A. A. Leonov, A. G. Nikolayev, T. D. Pitskhelauri, P. R. Popovich, Zh. D. Sergeychik, G. S. Shonin, I. B. Solovyeva, V. V. Tereshkova, G. S. Titov, B. V. Volynov, and D. A. Zaykin.

significantly from Dyna-Soar, but was very similar to the Spiral EPOS spaceplane. Through complex mathematical modeling and theoretical research, each cosmonaut developed a particular part of the spaceplane. Gagarin was responsible for the general layout, the aerodynamic design of elements ensuring landing, and control systems. Titov developed the emergency rescue system. Nikolayev created the aerodynamic form for hypersonic and supersonic speeds as well as the thermal protection."¹²⁰ The Air Force's decision to have all of these cosmonauts focus on the spaceplane theme underscored the fact that they were indeed very serious about the program."¹²¹

The Almaz, Zvezda, and Spiral projects were critical to Soviet plans to militarize space operations. Adding to the concurrent Soyuz, L1, and L3 programs, there were six major Soviet crewed projects by 1967, an impressive contrast to the two U.S. piloted space programs of the time. Apollo and MOL. From a political and public relations perspective, the military projects were, perhaps, less important than the three major efforts in support of crewed lunar operations. The military and civilian programs ran parallel with each other with some modicum of interdependence, but all were affected by cosmonaut Komarov's tragic death in April 1967. For those involved in Soyuz, L1, and L3, in particular, the disaster paralyzed their efforts with uncertainty and doubt. Numerous deadlines fell through the cracks as engineers from TsKBEM began their long, hard road back to recovery.

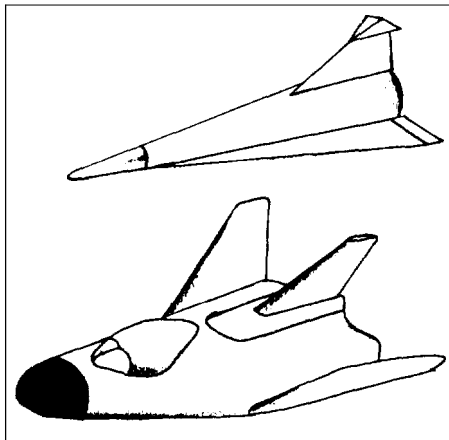

At top is a winged rocket-glider developed by the Tupolev design bureau in the early 1960s to carry out research at Mach 2-5 on the aerodynamic characteristics of a hypersonic winged vehicle. At bottom is the BOR-2 lifting body developed by the M. M. Gromov Flight-Research Institute in the late 1960s within the framework of the Spiral program (copyright Asif Siddiqi)

¹²⁰ *Ibid* pp 16-17 ²⁰ The topics of focus for some of the other cosmonauts were Zaykin (work on components and computation of mass characteristics) Popovich (power sources) Khrunov (orientation systems) Bykovskiy (propellant system for the liquid propellant rocket engine) and Sergeychik (safety systems on the flight)

¹²¹ There may have been a third competitor in the Soviet spaceplane programs apart from Mikoyans OKB 155 and Tupolev's OKB 156 General Designer P. O. Sukhoy's OKB 51 whose proposal was evidently based on an existing high speed bomber design named the T-4. In the early 1960s Sukhoy had proposed the creation of a new generation strategic supersonic bomber which was part of a competition with the Tupolev and A. S. Yakovlev (OKB 115) design bureaus. On May 21, 1963 Sukhoy presented his conception of the T-4 also known as the product 100 because it weighed 100-120 tons. The forty-four and a half meter long aircraft had a maximum design speed of 3,200 kilometers per hour (Mach 3.01) and a supersonic range of about 6,000 kilometers. The T-4 bomber made only ten test flights between August 1972 and January 1974, one of which achieved supersonic speed. The Soviet Air Force however soured on this technological marvel by the early 1970s believing that its goals could be performed by more conventional and reliable aircraft such as the famous Tu-145 also known as the Tu-22M Backfire bomber. Three prototypes of the T-4 were scrapped while a fourth one was consigned to an air museum after work was stopped in 1975. According to an interview with test pilot Maj. General V. S. Ilyushin on December 23, 1990 the T-4 was planned as a booster for a spaceplane. E-mail correspondence Sergey Voevodin to the author, September 2, 1997; letter Peter Pesavento to the author, August 15, 1997. See also Piotr Butowski 'Steps Towards Blackjack' *Air Enthusiast* 73 (January-February 1998) 36-49. L. L. Selyakov *Maloizvestnyye stranitsy tvorcheskoy deyatel'nosti aviatsionnogo konstruktora Vladimira Mikhaylovich Myasishcheva* (Moscow: AO ANTK im. Tupoleva, 1997) p. 112. Cunston *The Osprey Encyclopedia of Russian Aircraft* pp. 352-53. Mikhail Rebrov *The Unknown One Hundred* (English title) *Krasnaya zvezda*, September 13, 1995, p. 4. Svishchev *Aviatsiya entsiklopediya* pp. 550-51.

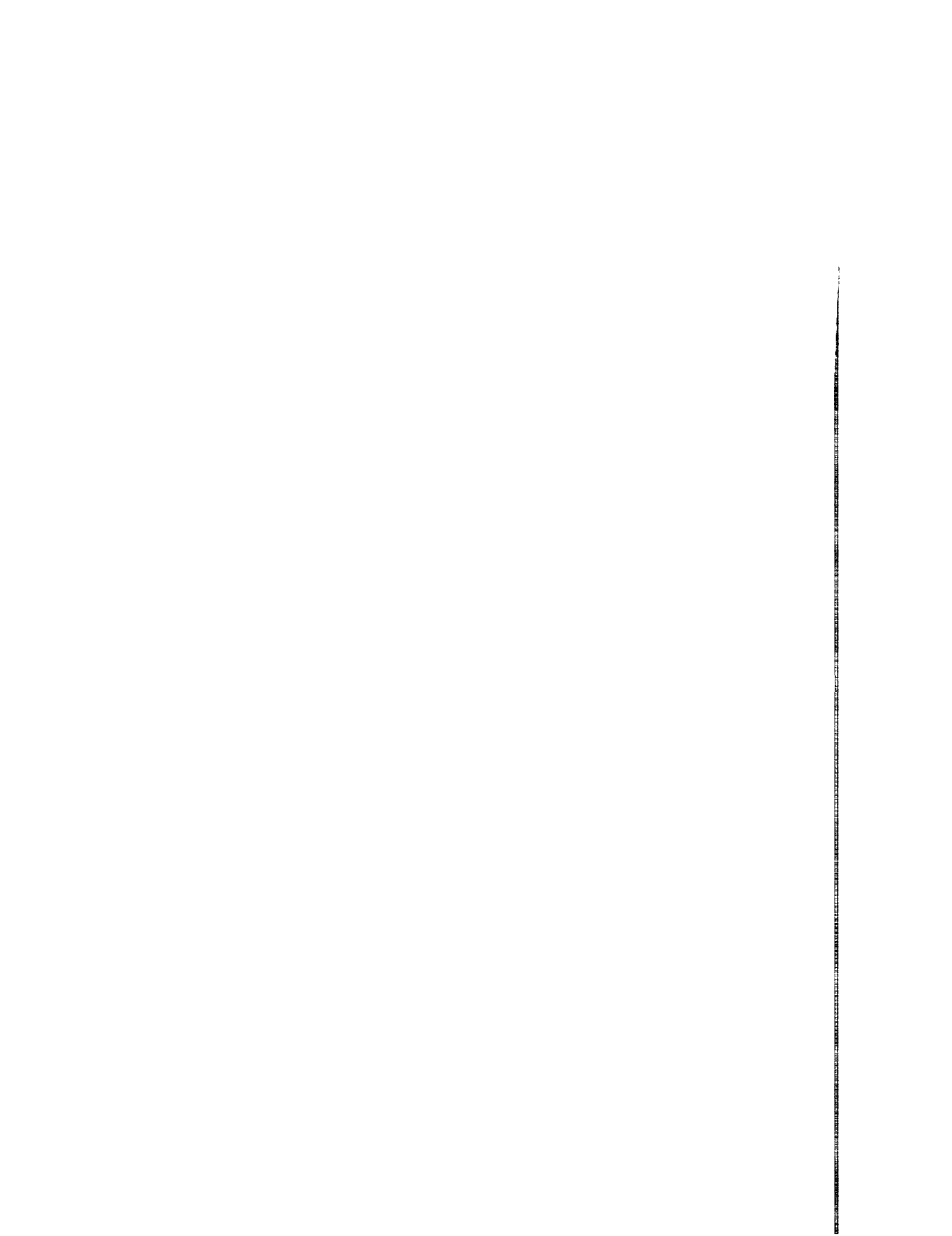



CHAPTER FOURTEEN GETTING BACK ON TRACK

The road out of the quagmire of the Soyuz I disaster was a difficult one. Because all three major piloted space projects—the Soyuz, the L1, and the L3—depended greatly on the vagaries of the basic Soyuz spacecraft, the accident had a widespread effect on the Soviet space program. Throughout 1966–67, the most important goal for the Soviets had been the celebration of the fiftieth anniversary of the Great October Revolution in November 1967 with a circumlunar flight of two cosmonauts in the L1 spacecraft. Because the L1 shared the same design as the Soyuz spacecraft that had killed Komarov, the disaster had grave implications for an early circumlunar flight. Technical issues were the primary determinant to any plans for lunar flyby in November 1967, but remarkably, the leading Soviet space officials still held out hope for meeting that increasingly elusive deadline.

The Tough Road Ahead

In late May 1967, two veteran NASA astronauts, Lt. Colonel Michael Collins and Lt. Colonel David R. Scott, arrived at the Paris Air Show to make a joint appearance with two Soviet cosmonauts, Colonel Pavel I. Belyayev and Konstantin P. Feoktistov. It was only a month after Komarov's death, but the unexpected meeting provided a brief but illuminating view of the Soviet space program. Over numerous toasts of vodka, what the astronauts found out was not so surprising: the cosmonauts indicated "that there would be several Earth orbital flights and then . . . a circumlunar flight."¹ As Collins later recalled, "Belyayev himself expected to make a circumlunar flight in the not-too-distant future."² The revelation was noteworthy precisely because of the almost complete information blackout on future plans in the Soviet space program. What was particularly astonishing was that despite the Soyuz I disaster, the Soviets were being remarkably optimistic in public of their circumlunar plans.

In October 1967, Academician Obraztsov stated with unusual explicitness that "the very next milestone in the conquest of space will be the manned circumnavigation of the Moon, and then a lunar landing."³ But as if to cover their bets, in their typically confusing way, Soviet

1 "Soviet Plans Manned Trip Round Moon " *Washington Post* June 4 1967 p. A9

2 Michael Collins *Carrying the Fire: An Astronaut's Journeys* (New York: Farrar, Straus and Giroux, 1974) p. 280

3 *Soviet Space Programs 1966–70: Goals and Purposes, Organization, Resources, Facilities, and Hardware: Manned and Unmanned Flight Programs, Bioastronautics, Civil and Military Applications, Projections of Future Plans, Attitudes Toward International Cooperation and Space Law*, prepared for the Committee on Aeronautical and Space Sciences, U.S. Senate, 92d Cong., 1st sess. (Washington, DC: U.S. Government Printing Office, December 1971) p. 366

spokespersons of the period ensured against the possibility of failure. Academician Leonid I. Sedov, the chairman of the "Commission for the Promotion of Interplanetary Flights" under the Academy of Sciences, was particularly notorious for brilliant obfuscations of the Soviet reach for the Moon. Because Western observers found it difficult to identify any single individual with real power within the Soviet space program, by default, many of Sedov's statements were magnified out of proportions, despite the fact that he had almost no connection whatsoever with the space program's operation. In September 1967, Sedov confidently told journalists that "manned flight to the Moon is not in the forefront of Soviet astronautics, as the problems of return from the Moon have still to be solved."⁴ It was a typically disingenuous statement that was symptomatic of the Soviet public relations effort of the time.

One of the more prominent pronouncements of the period was a cryptic news item in August 1967 that ten Soviet cosmonauts were practicing sea landing tests for future space missions.⁵ Unlike standard Earth-orbital flights, cosmonauts flying back from the Moon would potentially land in water areas because of the nature of their return trajectories. Among the group were four Air Force officers preparing for the commander's seat on the first lunar missions: veterans Leonov and Popovich and rookies Klimuk and Voloshin.⁶ Remarkably, because of poor planning and bureaucratic gridlock, the trainees did not have the luxury of a 7K-L1 spacecraft simulator throughout 1967. One interesting component of their training regime in 1966-67 was to rehearse for the possibility that it would not be sufficiently safe to launch cosmonauts on the Proton booster, and, therefore, they would have to transfer to the 7K-L1 in Earth orbit from a Soyuz ship launched on a more reliable IIA511 rocket. The cosmonauts flew on parabolic trajectories in a Tu-104 aircraft and used a special curved tunnel to carry out the transfer. The results of the training were not too encouraging, and it proved to be a very difficult exercise.⁷

Immediately after the Soyuz I accident, despite pervasive uncertainty, TsKBEM engineers had assumed that the problem with Soyuz I would be quickly identified and eliminated. Just six days after Komarov's death, Chief Designer Mishin set a new tentative plan for the circumlunar project, with four automated 7K-L1 spacecraft flying around the Moon between June and August 1967. They would be followed by three piloted flights on spacecraft 8L, 9L, and 10L in sufficient time to make the November 1967 deadline. By June, however, a one-month delay had already accumulated, possibly because of the extensive and time-consuming work of the Soyuz I accident investigation commission. The Komarov disaster had other repercussions on the L1 program. It was clear to most senior space program leaders that the Soyuz docking and EVA mission would be delayed possibly to early 1968. This meant that the cosmonauts would not have an opportunity to rehearse an extravehicular transfer prior to a dual-launch circumlunar flight. During a meeting of the L1 State Commission in early June 1967, Chairman Tyulin officially decided to abandon the docking-in-Earth-orbit option for the circumlunar project and opt for launching cosmonauts on the new UR-500K Proton booster. As

4 *Ibid* p 365

5 "Soviet Describes Splashdown Tests" *New York Times* August 25 1967 "Cosmonauts Train for Water Recoveries" *Aviation Week & Space Technology* September 11 1967 p 31 Viktor Mitroshenkov *Zemlya pod nebnom* (Moscow Sovetskaya rossiya 1987) p 424

6 There were twelve cosmonauts training for the L1 program in May 1967. They were pilots V. F. Bykovskiy, P. I. Klimuk, A. A. Leonov, A. C. Nikolayev, P. R. Popovich, and V. A. Voloshin, as well as engineers Yu. P. Artyukhin, G. M. Grechko, O. G. Makarov, N. N. Rukavishnikov, V. I. Sevastyanov, and A. F. Voronov. See Vadim Y. Molchanov "Soviet Manned Lunar Programs" *quest* 2(4) (Winter 1993) 43. Other sources give a slightly different composition. See for example I. A. Marinin and S. Kh. Shamsutdinov "Soviet Programs for Lunar Flights" (English title) *Zemlya i vseleennaya* no. 4 (July-August 1993) 62-69. Scientist V. C. Yershov is said to have joined the L1 training group in May 1967.

7 Marinin and Shamsutdinov "Soviet Programs for Lunar Flights"

a compensatory measure, he introduced two additional automated circumlunar missions into the flight sequence, making a total of six robotic flights before a piloted one. Of the six precursor missions, two had already flown in March and April 1967 with mixed success. The results of the remaining four would make or break the ability of the space program to make the sacred November 1967 deadline. The immense pressure to celebrate the anniversary with a piloted circumlunar mission was such that the first of the four remaining L1 ships would fly in July with the old parachute system because there was simply no time to install a modified version. corrected following Komarov's death."

If there was any hope left for a circumlunar flight before the end of 1967, by mid-July, it was clear to most in the State Commission that the engineers would simply be unable to make the deadline. The first fully equipped 7K-L1 vehicle, spacecraft no. 4, had only just finished its experimental testing in July after a long four months.⁸ TsKBEM Deputy Chief Designer Yevgeniy V. Shabarov, overseeing the preparation of the vehicle, spent many long days ensconced at the Kaliningrad plant eliminating problems from the vehicle. Preflight testing, usually lasting several weeks, had yet to even begin. Top Communist Party and government leaders, such as Ustinov, Serbin, and Smirnov, were simply in a state of panic, knowing that the first launch of the Saturn V was slated for late 1967, while the NI was still many months away from flight. At a meeting of top officials in August 1967, Secretary of the Central Committee for Defense and Space Ustinov was infuriated. He told Mishin: "We have a celebration in two months, and the Americans are going to launch again, but what about us? What have we done? Imagine October 1967. Please understand this! We must suppress all personal interests and partiality!"⁹

On September 7, the L1 State Commission met to set a date for the launch of the first automated circumlunar flight of a 7K-L1 spacecraft. Several chief designers, including Mishin, Ryazanskiy (radio-control systems), and Barmin (launch complexes), reported on the readiness of the booster and the spacecraft. Although many of the participants believed that their systems were 99 to 99.9 percent reliable, Mishin himself believed that the complete booster-payload system had a reliability rate of 60 percent, illustrating a remarkable lack of faith in the equipment. According to the plan, after flying around the Moon and heading toward Earth, the spacecraft would have the option of two different reentry profiles: a direct ballistic reentry into a 100- by 2,000-kilometer area in the Indian Ocean or the more preferable guided reentry in Kazakhstan. As a precautionary measure, the Soviet government signed an agreement with the Indian government in early September that would allow Soviet spacecraft to be brought to Indian soil following recovery.¹⁰

There were several malfunctions during the days leading up to the planned launch, but nothing critical enough to delay an automated flight. The 7K-L1 vehicle, spacecraft no. 4L, lifted off precisely on time in the dark night at Tyura-Tam at 0111 hours, 54 seconds Moscow Time on September 28, 1967. Air Force representative Lt. General Kamanin recalled the scene:

⁸ N Kamanin "A Goal Worth Working for" (English title) *Vozdushniy transport* 46 (1993) 8-9

⁹ Yu P Semenov ed *Raketno-Kosmicheskaya Korporatsiya "Energiya" imeni S P Koroleva* (Korolev RKK Energiya named after S P Korolev 1996) p 241

¹⁰ A Tarasov "Missions in Dreams and Reality" (English title) *Pravda* October 20 1989 p 4

¹¹ Others reporting included Yu N Trufanov (TsKBEM Branch No. 1 responsible for the UR 500K Proton) and P A Agadzhanov (Chief of the Chief Operations and Control Group and Deputy Chief of TsKIK)

¹² NASA Science and Technology Division *Astronautics and Aeronautics 1967 Chronology of Science Technology and Policy* (Washington DC NASA Special Publication (SP) 4008 1968) p 321 Another source says that the agreement between the two countries was signed on November 18 1967 See Christian Lardier *L'Astronautique Soviétique* (Paris Armand Colin 1992) p 161



This still from a movie shows the transport of a 7K-L1 circumlunar spacecraft on its Proton booster on the way from the assembly building to the launch pad at Tyura Tam. Note the cluster of solid-propellant rocket engines at the top of the launch escape tower. The hatch on the external fairing for cosmonaut entry into the actual spacecraft can be seen in the foreground as a dark oblong shape. (files of Asif Siddiqi)

It immediately seemed to me, as well as other observers, that the rocket was going up *slower* than usual. But none of us counted seconds, and we all hoped that it was the rocket's unusual night launch that inhibited our ability to assess the takeoff adequately. When the first stage's side units *decoupled*, we were prepared to cast off doubts, but suddenly the automatic rescue system came into action, and the burning mass abruptly changed its path and began *moving* down to Earth. . . ."

It later transpired that one of the six main engines of the Proton first stage had failed to fire at launch. Remarkably, the ascent was steady for sixty-one seconds before diverting from a nominal path, which provoked the emergency rescue system into action. The booster itself crashed about sixty-five kilometers from the pad amid the thunder of loud explosions. The L1 descent apparatus separated from the wandering launch vehicle on time. Although the capsule was destabilized at the moment of separation because of an unexpected pressure shock, the vehicle landed safely in one piece not far from the exploded booster. When rescuers arrived, they were greeted by a strange scene: from one end of the horizon to the other, there was an eerie yellowish-brown cloud of nitrogen tetroxide and unsymmetrical dimethyl hydrazine all over the steppes. The descent apparatus lay majestically on top of a hill amid the toxic vapors." The difficulty in rescuing the capsule was a nagging reminder of the dangers of using storable

13 N. Kamanin "A Coal Worth Working for" (English title) *Vozdushniy transport* 47 (1993) 8-9
 14 Semenov ed. *Raketno Kosmicheskaya Korporatsiya* p. 241

propellants on a booster intended for launching humans into space. If there had been a crew aboard the descent apparatus, they might possibly have been exposed to the dangerous propellants.

With the foregone conclusion that there would not be any piloted circumlunar missions in 1967, the engineers trudged on with their work on the next 7K-L1 spacecraft. Late on the day of the launch failure, some members of the State Commission met to discuss the preliminary results of the accident investigation. Chief Designer Mishin, perhaps to lift the rapidly falling spirits of his engineers, told those present that they should not be discouraged and should work even more energetically for the next flight of the L1 spacecraft, tentatively set for the next lunar launch window in two months. It would be a busy time for TsKBEM engineers because Mishin had also scheduled the first post-Komarov flights of the Soyuz spacecraft in October. These would be followed by the L1 launch on November 21–22.¹⁵

On October 7, there was a major meeting at the Kremlin presided by Ustinov to discuss various aspects of the troubled L1 program. Chief Designer Glushko reported on the reasons for the unfortunate Proton failure on September 28. The single engine failure on the first stage had occurred because of the blocking of the propellant supply system by a rubber plug. The plug had evidently fallen into the engine during its assembly at Plant No. 19 at Perm, where the units were manufactured on order from Glushko's Design Bureau of Power Machine Building (formerly OKB-456). Ustinov castigated Minister of Aviation Industries Petr V. Derentyev for his negligence in the matter, telling his audience that the Proton failure had cost the Soviet government 100 million rubles and a two- to three-month delay in the circumlunar program. All the reports, from Minister of General Machine Building Afanasyev, Mishin, Tyulin, Chelomey, and others, were filled with recriminations against subcontractors who were inefficient in their deliveries."

The fiftieth anniversary of the Great October Revolution passed with much fanfare in the first week of November 1967 all over the Soviet Union. But for those involved in the space program, it was a time marked by the acknowledgment that their handiwork had failed the task given them by the Soviet government. Since 1964–65, numerous decrees and decisions from the Central Committee, the Council of Ministers, the Military-Industrial Commission, and the Ministry of General Machine Building had all aimed for this date as the holy grail of Soviet cosmonautics—the month when two Soviet citizens would fly around the Moon and bring their hammer-and-sickle flags back to parades and celebrations in honor of the Bolsheviks. It, of course, never happened that way. Engineers, cosmonauts, chief designers, ministers, and military officers all dug back into preparations for the next circumlunar launch attempt. A success would bring some consolation to a beleaguered effort.

In mid-November, L1 State Commission Chairman Tyulin arrived at Tyura-Tam to oversee the prelaunch testing of the flight vehicle, the 7K-L1, spacecraft no. 5L. Several of the lunar cosmonauts, including Leonov, Popovich, and Dobrovolskiy, were escorted to the launch site by Karnanin on the morning of November 18.¹⁷ After the launch, they were evidently to fly to Yevpatoriya to participate in the control of the vehicle during its weeklong circumlunar mission. The only prominent chief designer present at the launch range to oversee preparations was Glushko; Mishin and Chelomey did not arrive until 36 and 11 hours, respectively, before launch, probably because of numerous prior commitments in several other concurrent projects. It was a particularly chilly launch night at Tyura-Tam, with the Moon beautifully suspended over the Proton

15 Kamanin, "A Goal Worth Working for," no. 47

16 *Ibid* Cosmonaut A. A. Leonov has also described the reason for the Proton failure "It turned out that a rubber plug had fallen into the manifold ahead of the turbopump assembly. Having gotten stuck in the line, it cut off the fuel feed." See Major I. Kuznetsov "The Flight That Did Not Occur" (English). *Aviatsiya i kosmonavtika* no. 8 (August 1990): 44–45.

17. Mitroshenkov. *Zemlya pod nebom*, p. 426.

launch pad. The 7K-LI spacecraft lifted off just after midnight local time, 2208 hours Moscow Time, on November 22, 1967. Everything seemed to be working perfectly until second-stage operation, when one of the four engines of the second stage failed to ignite. The remaining three engines continued to fire for four additional seconds until an automatic signal from the ground detecting trajectory deviation shut them off. Once again, the emergency rescue system fired on time and shot the LI descent apparatus away from the launch vehicle. The descent apparatus crashed about 300 kilometers from the pad, while the automated crew capsule flew eighty kilometers southwest of the town of Dzhezkazgan. Because of a spurious command from the vehicle's altimeter, the soft-landing engines fired at an altitude of four and a half kilometers instead of just prior to touchdown, causing the capsule to perform a "hard" landing. Engineers later added a filter to the gamma-ray altimeter to preclude such malfunctions, in both the LI and Soyuz spacecraft.¹⁸

At the end of 1967, the pressure was off Mishin a little bit. No longer chasing after an impossible target, his immediate goal was to beat the Americans in a circumlunar flight. Given that piloted Apollo operations were not expected to resume prior to the fall of 1968, the Soviets could be forgiven for being optimistic about doing just that. The accumulated delays allowed engineers to continue fine-tuning the 7K-LI spacecraft design. One of their ultimate goals was to replace the original *Argon-11* computer by the more improved *Salyut-1* model sometime in 1967-68. The engineers also continued to shave off weight from the vehicle in an attempt to optimize its capabilities. The major changes introduced into the Soyuz spacecraft parachute system were also incorporated into the LI. The results of the testing were, however, not very encouraging. On January 26, during a test of the LI landing system at the Air Force range at Vladimirovka near Kapustin Yar, the parachute shot out and filled with air but abruptly collapsed, and the capsule crashed on to the ground and exploded."

In January, the LI cosmonauts finally began training in a specially built simulator delivered by the Special Experimental Design Bureau of the M. M. Gromov Flight-Research Institute at Zhukovskiy near Moscow. The simulator, known as *Volchok* ("Top"), was installed at the Air Force's Institute of Aviation and Space Medicine to allow cosmonauts to train for the return to Earth at lunar velocities. The simulator was part of a complex that included an M-220 computer, a centrifuge, the LI cockpit, and an instructor's control panel. The LI group conducted at least seventy runs on the simulator using precise methodologies for the circumlunar training program consisting of the two different reentry profiles: one ballistic and the other guided. The favorite to command the first circumlunar mission, cosmonaut Leonov, later recalled:

We had to learn to choose the angle of entry after the last [mid-course] correction using the star-tracker and sextant. [The angle] depended on the magnitude and direction of the deceleration burn. It was possible to "bury" oneself in the atmosphere with a large angle and to "slip through" it with a small angle. The optimum version was an entry with a "pop-up": enter, exit the atmosphere after extinguishing great speed, and reenter, already knowing the angle of incidence at which the craft had to be held to get to the calculated landing point. The "manual firing input" instrument highlighted the number of burns after passage of the first sector. From that we figured the distance to the calculated landing point, then converted distance into angle of incidence. . . . As a result we learned to make a "landing" with an accuracy to one kilometer.!"

18 Semenov ed *Raketno Kosmicheskaya Korporatsiya* p 241; Kamanin "A Goal Worth Working for" no 47

19 N Kamanin "A Goal Worth Working for" (English title) *Vordushniy transport* 48 (1993) 8-9

20 Kuznetsov "The Flight That Did Not Occur." p 44

General LI training consisted of studying the 7K-LI ship's on-board systems, the dynamics of its motion, mathematical support, programming, ballistics, and astro-navigation. Included in the cosmonauts' training program was a ten-day trip to Mogadishu, Somalia, in the summer of 1968 to familiarize themselves with the constellations in the southern sky: returning LI vehicles would fly over Antarctica, then Africa, before heading toward Soviet territory. On an actual flight, the vehicle would use its star-tracker and sextant for autonomous navigation, and the cosmonaut would take over in case of sensor malfunction."

By early February 1968, Mishin and Kamanin had agreed on the selection of four crew commanders to train for the first few missions: cosmonauts Bykovskiy, Leonov, Popovich, and Voloshin." They, along with eight others, were engaged in an intensive program throughout 1967-68, but it seems that they did not have much confidence in the spacecraft. Kamanin recalled in early March that:

[The cosmonauts] are working diligently and know the craft well. Perhaps, it is precisely because the cosmonauts excellently know all the strong and weak points of the craft and the carrier rocket that they no longer have their initial faith in the space hardware."

In their training in the LI simulators, the cosmonauts remarked that although it was quite easy to work with the new instrumentation, it would be a very trying job to spend about seven days cramped in the tiny descent apparatus of the 7K-LI vehicle.²¹ The two recent launch failures of the Proton booster did not do much to raise their spirits.

The next LI launch was set for March 1-2, 1968. The unusually long gap between the fourth and fifth LI flight attempts was partly a result of the poor results of the emergency rescue system's ground testing of the UR-500K-LI booster stack, carried out under Deputy Chief Designer Tsybin's direction. There were evidently repeated parachute failures in the escape system in January and February, but the necessity to maintain deadlines prompted him to recommend launches despite complete confidence in the systems. On February 20, the LI State Commission met, presided over by an ill Tyulin. General Designer Chelomey and Chief Designer Aleksandr D. Konopatov of the Design Bureau of Chemical Automation, responsible for the Proton's second-stage engines, briefed the attendees on the possible reasons for the two consecutive failures in late 1967. While the specific cause of the November 1967 malfunction was still unknown, the two designers believed that the premature ignition of propellant because of local heating to more than 200 degrees Centigrade led the suspect engine to fail. Chelomey, Konopatov, and Mishin proposed a number of changes to the engine design—suggestions that were approved by the remaining members of the State Commission. At this point, the State Commission still planned to carry out four more fully automated LI flights before proceeding with a crewed flight.

A number of the cosmonauts training for the LI program, including Bykovskiy, Leonov, Popovich, and Sevastyanov, flew to Tyura-Tam in a Tu-124 aircraft on February 28, 1968,

21 *Ibid* Marinin and Shamsutdinov "Soviet Programs for Lunar Flights"

22 Kamanin "A Goal Worth Working for" no. 48. By this point five tentative crews had been formed for the LI program: A. A. Leonov/O. G. Makarov/V. F. Bykovskiy/N. N. Rukavishnikov/P. R. Popovich/V. I. Sevastyanov/V. A. Voloshin/Yu. P. Artyukhin and P. I. Klimuk/A. F. Voronov. In addition one civilian scientist V. G. Yershov and another civilian engineer G. M. Grechko also trained with the core group of ten. For crew complements see S. Shamsutdinov and I. Marinin "Flights Which Never Happened: The Lunar Program" (English title) *Aviatsiya i kosmonautika* no. 2 (February 1993): 30-31.

23 Kamanin "A Goal Worth Working for" no. 48 p. 9.

24 I. B. Afanasyev "Unknown Spacecraft (From the History of the Soviet Space Program)" (English title) *Nouoye v zhizni Nauke tekhnike Seriya kosmonautika astronomiya* no. 12 (December 1991): 1-64.

accompanied by cosmonaut overseer Col. General Kamanin and first cosmonaut Gagarin, who, although he was not preparing for a mission, was closely involved in the L1 cosmonauts' training program." It was very windy and cold at the launch site, and the snow cover gave the area a beautiful sheen. Later that day, the State Commission held a meeting to discuss the specific plans for the next launch, set for March 2. Besides Mishin and Chelomey, their deputies for the 7K-L1 and the Proton booster—Yevgeniy V. Shabarov and Yuriy N. Trufanov, respectively—spoke on the readiness of all the preparations. Because there was no lunar launch window at the time, Mishin and Chelomey had agreed to launch the spacecraft out to a distance of about 330,000 kilometers into deep space—that is, out to lunar distance—and then bring the vehicle back to Earth, thus simulating an actual circumlunar flight. The nonlunar objective also gave launch controllers the luxury of having launch windows lasting more than just a few seconds. The next 7K-L1 launch, slated at the time for April 23, would fly to the Moon."

There was a remarkable lack of confidence during the preflight preparations. Even State Commission Chairman Tyulin had misgivings about the launch. Kamanin wrote in his journal on March 1: "All of us need a successful launch like a breath of fresh air. Another failure would bring innumerable troubles and may kill the people's confidence in themselves and the reliability of our space equipment."²⁵ The 7K-L1 ship, spacecraft no. 6L, lifted off at 2129 hours, 23 seconds Moscow Time on March 2, 1968, into a circular Earth orbit at around 200 kilometers altitude at a fifty-one-and-a-half-degree inclination. Exactly one hour, eleven minutes, and fifty-six seconds after launch, the Blok D stage fired for 459 seconds to boost the spaceship into a highly elliptical orbit with an apogee of 354,000 kilometers. The Soviet news agency TASS did not announce anything of note about the launch, except to name the spaceship *Zond 4* ("zond" being the Russian word for "probe"). The Zond designation had previously been used for three completely unrelated deep space probes in the early 1960s, and it was a curious excavation of an obsolete moniker. Retroactively, the Soviets would call the entire circumlunar effort the Zond program.

The day after launch, a group of cosmonauts led by Gagarin flew to the flight control center at Yevpatoriya to support the activities of the Chief Operations and Control Group. The L1 crew of Popovich and Sevastyanov, one of the leading contenders for an early mission, spent long periods in a special "bunker" at Yevpatoriya, playing the role of an actual flight crew. Communications between the two were routed through Zond 4 back to Yevpatoriya to simulate as closely as possible realistic conditions during an actual mission.."

The first minor sign of trouble on the flight appeared on the morning of March 4. At 0753 hours Moscow Time, the controllers attempted to carry out the first mid-course correction, but they failed to do so because of a failure in the attitude control system: the 100K stellar sensor (using minimum shading) correctly tracked the Sun, but failed to find Sirius. The first mid-course correction was, however, not a necessary factor for a successful mission, and engineers were confident that everything would work fine. All systems on Zond 4, including the communications systems, were working without serious disruptions, although the main omnidirectional antenna had evidently not unfurled properly. A second attempt to use the stellar orientation system on March 5 was also a failure: the sensor tracked Sirius for only a few seconds (with maximum shading) before losing it, suggesting some sort of malfunction in the astro-orientation sensor built by

²⁵ Mitroshenkov *Zemlya pod nebom* p. 436

²⁶ Kamanin "A Goal Worth Working for" no. 48 The March mission was timed to be launched a half lunar month outside the nominal lunar launch window and was in fact aimed in the exact opposite direction of the Moon

²⁷ *Ibid* p. 9

²⁸ Marinin and Sharnsutdinov 'Soviet Programs for Lunar Flights' Sharnsutdinov and Marinin 'Flights Which Never Happened' *The Lunar Program* '

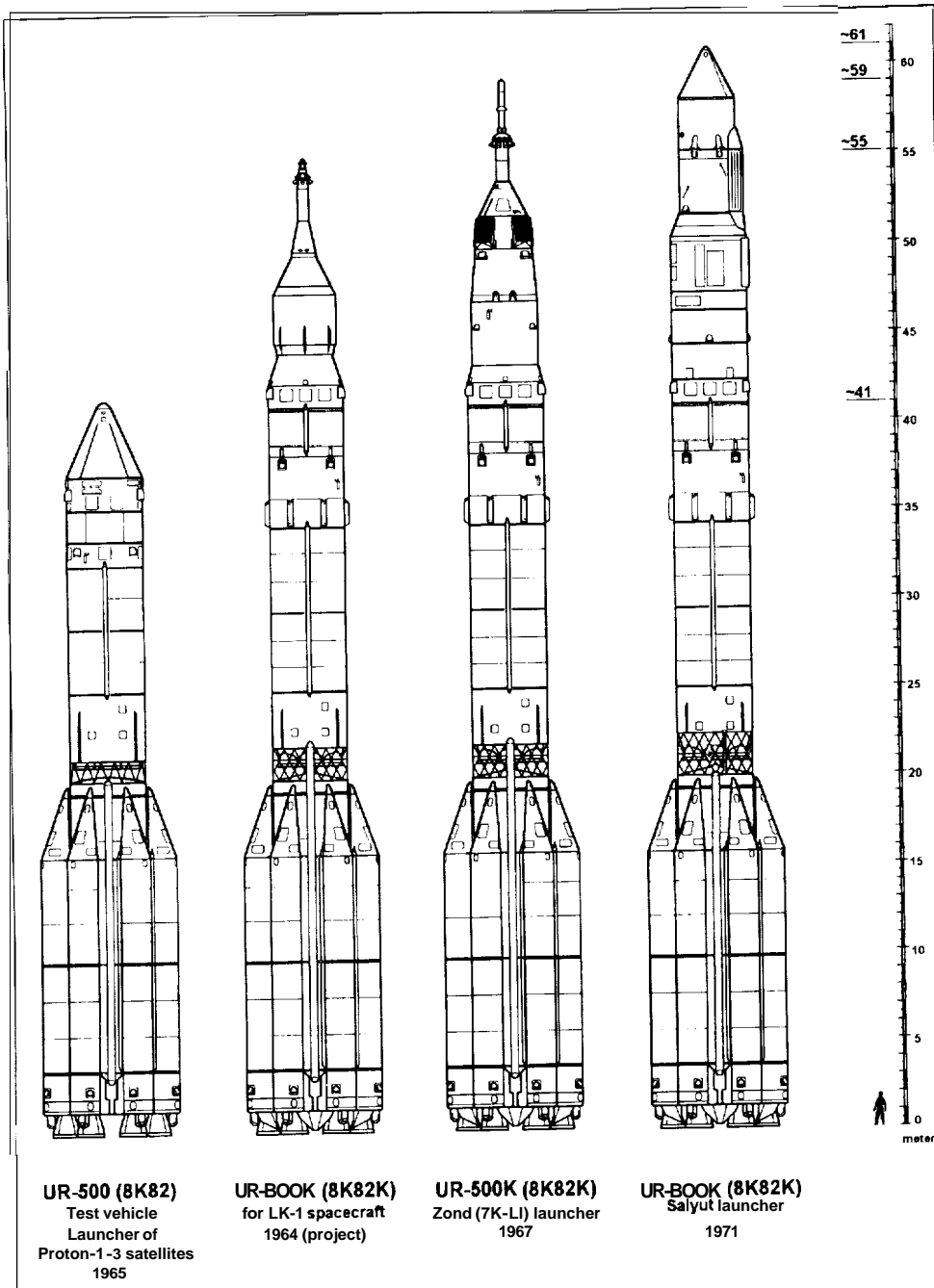

This shows the evolution of the UR 500 space launch vehicle. For many years, Westerners believed that the clustered modules of the first stage were strap-on boosters. These were in fact only propellant tanks and not self-contained stages. (copyright Peter Quinn)

the Ceofizika Central Design Bureau. The engineers finally declared success the next day when a medium-density filter on the sensor proved to be the right solution to the stellar tracking problem. The vehicle was oriented properly and fired its main engine to sharpen its trajectory.²⁹ Ballistics calculations showed that Zond 4's trajectory was perfect and that there would be no need for further mid-course corrections. The vehicle was expected to enter Earth's atmosphere down to an altitude of only 45.8 kilometers, then bounce out to 145 kilometers and then reenter again.

In the complex schema of Soviet ground control over spacecraft, the Zond flights were controlled from Yevpatoriya, but supported by ballistics centers at NII-4 in Bolshevo and a new Coordination-Computation Center at the premises of the Central Scientific-Research Institute for Machine Building (TsNII Mash) located right next to TskBEM in Kaliningrad. The Coordination-Computation Center had provided only ballistics support for space missions since January 1963, but it had steadily expanded its activities in the mid-1960s to support the piloted lunar program. It would eventually form the basis for the famous Flight Control Center (TsUP) that controlled all missions to the Mir space station.³⁰ Some of the Air Force officers involved with the Zond 4 flight were in attendance at the Coordination-Computation Center during the return portion of the spacecraft's trajectory as they saw the projected "pop-up" trajectory mapped out on giant screens in front of them. But the projections were unfortunately markedly different from the true path of Zond 4 on March 11. After the vehicle separated into its two component parts, the descent apparatus was evidently in the wrong attitude because of the "unpreparedness of the orientation system." Thus the spacecraft entered the atmosphere into the correct corridor, but then never left it. Instead, it entered into an uncontrollable ballistic trajectory. It evidently passed through the atmosphere safely and was about to deploy its parachutes, when at an altitude of ten to fifteen kilometers over the Gulf of Guinea near the west African coast, the emergency destruct system of the descent apparatus was commanded to explode the capsule. The destructive charge had been included on the spacecraft for precisely such a contingency: "for fear that the Americans may get hold of it."³¹ The Soviet press refrained from commenting on Zond 4's fate, although in later years, official Soviet publications would say that the spacecraft was in heliocentric orbit.³² The order to destruct had strong support: Tyulin and Mishin evidently cleared the decision through Central Committee Secretary Ustrnov and Military-industrial Commission Chairman Smirnov.

A crew in the spacecraft would have endured up to twenty g's during the descent, but would probably have survived the splashdown. The main problem on the Zond 4 spacecraft was traced to the 100K stellar sensor, whose surface had evidently been contaminated. For future vehicles, engineers introduced a special cover for the sensor, which would be cast off before use. The State Commission for the L1 program met on the afternoon of March 26, 1968, to discuss the status of the project. TskBEM Deputy Chief Designer Chertok summarized all the failures of the stellar attitude control sensor on Zond 4 as well as the results from the flight.

29 Kamanin 'A Goal Worth Working for' no. 48

30 The genealogy of this center can be traced back to May 13, 1959, when the Council of Ministers issued a decree for the formation of a Computation Center (VTs) at the premises of NII 88 in Kaliningrad. In January 1963 it assumed the role of one of the many ballistics centers for space missions. In October 1964 this ballistics center served as the chief ballistics center for the Voskhod mission. A second decree of the Central Committee and the Council of Ministers on October 25, 1965, led to the creation of the Coordination Computation Center (KVTs) on the basis of the ballistics center. See V. I. Lobachev, V. N. Pokuchayev, and N. P. Shcherbakova, "30 October—30 Years From the Beginning of Functioning of the Computation Center of the NII-88 (TsNII Mash): Assumed as the Start of Creation of the Soviet Flight Control Center (1960)" (English title) *Iz istorii aviatsii i kosmonavtiki* 64 (1993): 98-106.

31 Kamanin 'A Goal Worth Working for' no. 48. Semenov, ed. *Raketno Kosmicheskaya Korporatsiya* p. 241. The mission duration was about ten days, nineteen hours.

32 See, for example, Yu. A. Mozzhorin, ed. *Kosmonavtika* (Moscow: Mashinostroyeniye, 1981), p. 446.

Mishin reported that the next 7K-LI vehicle and its Proton booster would be ready for the next launch by April 20–22, in time for the next lunar launch window just after midnight local time on April 23."

The LI spacecraft arrived at the Baykonur Cosmodrome on April 12, the anniversary of Gagarin's Vostok flight in 1961. State Commission members Tyulin and others flew into the launch range four days later in preparation for the launch. Hopes were high that this would be the first fully successful automated circumlunar mission in the Soviet space program. The preparations for the launch proceeded without significant problems. The unusually cold April temperatures, down to minus five degrees Centigrade at night, did not deter work, which was concurrent with an unrelated Soyuz precursor flight in Earth orbit. The cosmonauts and officials were housed for the first time in the new Kosmonavt Hotel, a fully furnished abode for crews to spend their days before launch. On the morning of April 20, the State Commission met to go over all the changes in the 7K-LI vehicle since the flight of Zond 4, including the modifications to the critical stellar sensor, responsible for the demoralizing failure at the end of the mission.³⁴

At a last meeting on April 22, one of the topics of discussion was whether to blow up future 7K-LI spacecraft if they returned to Earth in uncontrolled trajectories. Chief Designer Mishin, along with Deputy Chief Designer Shabarov, vigorously supported such a contingency but were opposed by Chief Designer Barmin, Kamanin, and all the cosmonauts. Many, including Chelomey, remained neutral, perhaps unwilling to take a stand on an issue that had implications for national security. In the end, a final decision seems to have been postponed: Mishin evidently believed that a ballistic landing would be unlikely on this particular flight.

It was another cold night launch for the program. The UR-500K rocket lifted off precisely on schedule at 2301 hours, 7 seconds Moscow Time on April 22 with the 7K-LI, spacecraft no. 7L. The rocket flew gracefully into the dark skies as observers watched the exhaust become smaller and smaller. About seven minutes after launch, at T+260 seconds, the flame abruptly disappeared, although the third stage had yet to fire. It was clear that there had been some malfunction and that the emergency rescue system had been activated. The controllers at Tyura-Tam received a report from the rescue service about four hours after launch that the LI descent apparatus had landed 520 kilometers from the launch site, about 110 kilometers east of the town of Dzhezkazgan in Kazakhstan. The initial reports were distressing: a helicopter commander relayed that he had located the capsule but that it was on fire, an impression confirmed by search service commander Air Force Maj. General Aleksandr I. Kutasin. In the morning, it turned out that both had been mistaken; the 7K-LI capsule landed without problems, and all elements of its rescue system had worked flawlessly. By the afternoon, the capsule was back at Tyura-Tam, a stop on its trip back to Moscow the following day."

A cursory investigation into the accident indicated that the failure was not because of a booster problem. A sensor on the spacecraft had erroneously detected a breakdown and ordered the booster's second-stage engines to shut down and abort the flight. By the late morning of April 23, engineers were leaning toward some sort of failure in the 7K-LI's power supply system. The failure laid to rest any hope that there would be a crewed circumlunar flight before the fall of 1968 at the earliest. Of the four LI attempts in 1967–68 to fly to lunar distances, only one, Zond 4, had been a partial success. The remaining three had failed to reach even Earth orbit, underlying serious problems in the launch vehicle. The entire program was already more than a year behind schedule, with many tests still to be carried out. With little

33 N Kamanin "For Him, Living Meant Flying" (English title), *Vozdushniy transport* 9 (1994) 8

34 N Kamanin "For Him Living Meant Flying" (English title) *Vozdushniy transport* 12 (1994) 12

35 N Kamanin "A Goal Worth Working for" (English title) *Vozdushniy transport* 49 (1993) 8

hope of an impending piloted mission, the LI cosmonauts were sent on leave on June 1, 1968. On May 20, Mishin held a meeting at his design bureau and targeted July 17 as the next launch opportunity for a circumlunar flight, putting a three-month gap between missions. The accident investigation of the last launch failure was evidently a big factor in the long interval.

Not surprisingly, the political leadership at this time was extremely disconcerted by the continuing series of failures in the program. Mishin met with Military-Industrial Chairman Smirnov in May 1968 to discuss the status of the project. The latter asked Mishin to accelerate the pace of work on the LI as much as possible to launch a crew around the Moon by October 1968. Smirnov's boss, Ustinov, had also set the same deadline, which took into account three more automated launches in July, August, and September, leading to a flight by two cosmonauts in October.³⁶ Despite the spate of setbacks, publicly the Soviets continued to maintain their interest in a piloted circumlunar flight. On a tour of Hungary in February 1968, cosmonauts Belyayev and Bykovskiy were remarkably explicit in their pronouncements. The latter, one of the leading candidates for commanding the first circumlunar flight, told journalists:

The Soviet Union will send men to the Moon only when there is no longer any risk, and there is every guarantee that a safe return can be made. One of our next steps is not a Moon landing, but the orbiting of the Moon by a manned space vehicle. Naturally [the death of Komarov] had a certain retarding effect. It took many weeks to investigate and learn the causes of the accident. However, it caused no essential revisions in the space research and spaceship development program which had been worked out."

In a hint of the troubles facing the circumlunar project, Academician Vasily V. Parin, one of the leading space biomedicine specialists in the Soviet space program, did admit that precursor "pathfinder" flights could delay the first Soviet piloted lunar mission.³⁸

U.S. observers were also getting in on the act. Through the spring of 1968, U.S. government officials and the American press were unusually vocal about imminent Soviet space plans. Noted journalist John Noble Wilford wrote in February that among the immediate goals of the Soviet space program was "[a]n unmanned flight of the Soyuz around the moon and back to earth, without attempting a landing on the lunar surface . . . this summer."³⁹ That U.S. intelligence was clearly cognizant of the troubles plaguing the Soviet space program at the time was confirmed by articles in the U.S. media, clearly noting the two recent LI launch failures in November 1967 and April 1968, which were covered up by the Soviets.⁴⁰ The knowledge of these failures does not seem, however, to have given pause to exclamatory pronouncements in the American media. In a prominent page-one article in *The New York Times* on May 5, a reporter claimed: "A mass of public and private evidence about the Soviet Union's recent space exploits has led analysts to believe that the American public is in for a series of space surprises."⁴¹ No one could guess at the paramount level of managerial, technological, and funding chaos plaguing the Soviet piloted space effort.

36 N. Kamanin, "For Him, Living Meant Flying" (English title), *Vozdushnyi transport* 16 (1994) 11

37 *Soviet Space Programs, 1966-70*, p. 368. "Moon Fly-Around by Soviet Likely," *Baltimore Sun*, February 26, 1968, p. A3

38 NASA Science and Technology Division, *Astronautics and Aeronautics 1968. Chronology of Science, Technology, and Policy* (Washington, DC: NASA SP-4010, 1969), p. 105.

39. John Noble Wilford, "Renewed Soviet Space Drive Likely," *New York Times*, February 18, 1968, p. 18

40 See, for example, Evert Clark, "Soviet Resumes Tests of Orbital Bombing System," *New York Times*, April 26, 1968, p. 35.

41 Evert Clark, "Soviet Advances in Space Awaited," *New York Times*, May 5, 1968, pp. 1, 50. For other articles claiming a big Soviet push in space, see Evert Clark, "Manned Flight Expected," *New York Times*, April 16, 1968, p. 37; Raymond H. Anderson, "Soviets in Space: A New Glamour Phase," *New York Times*, April 28, 1968, Section IV, p. 11.

A little more than a month after that article, on June 26, 1967, the LI State Commission met to discuss preparations for the next launch. Engineers from TsKBEM admitted that they, and not Chelomey's engineers responsible for the Proton booster, had been to blame for the most recent LI launch failure in April. A short circuit in the power supply system of the spacecraft's computer resulted in the "Accident in the Autonomous Guidance System" command being sent from the vehicle to the booster. Consequently, the engines in the second stage of the Proton automatically switched off. The problem was traced to a design error on the part of Department No. 212 at the TsKBEM, which had incorrectly mounted the three-axis stabilized platform in the descent apparatus of the LI.⁴² Mishin and Tyulin agreed to attempt the next circumlunar launch on July 19. This flight would be followed by similar launches in August, September, and October. After three to four automated flights of the UR-500K-LI system, cosmonauts would fly to the Moon in November–December 1968, well over a year later than originally intended.

This schedule was again put into jeopardy as a result of a near-catastrophic accident at Tyura-Tam during the summer of 1968. On July 15, four days prior to the intended launch, the 7K-LI spacecraft, the Proton booster, and the Blok D upper stage were undergoing combined testing at the launch pad at the Baykonur Cosmodrome. The stack had already been fully loaded with propellant when the oxidizer tank of the Blok D stage exploded. The first reports suggested that the rocket, the spacecraft, and the pad were destroyed, killing three pad technicians. Later, it transpired that although the Blok D stage was destroyed, both the UR-500K launcher and its LI payload were relatively intact. One person, a Captain I. D. Khridin, had been killed and another seriously injured. The accident had occurred because of an erroneous electrical command from a malfunctioning ground cable network, which resulted in excess pressure in Blok D. The situation after the accident was extremely dangerous. The LI spacecraft and part of Blok D tipped over to one side, supported only by the emergency rescue system tower, which was stuck on a service girder on the pad structure. Blok D's fuel tank, with five tons of kerosene and two attitude control engines with their own oxidizer and fuel, had broken away from the girder and had pushed deep into the third stage of the Proton. Observers watched in terror as the seriousness of the situation became deathly clear. At the time of the accident, the payload contained five tons of fuel in Blok D, one and a half tons of solid propellant in the emergency rescue system tower, more than one and a half tons of toxic propellants for Blok D's attitude control system, thirty kilograms of highly concentrated hydrogen peroxide in the LI's guided reentry system, four and a half liters of triethylamine for the ignition of the Blok D propellants, benzine-based fuel for the thermo-regulation system connected to more than 150 pyrocartridges, and twenty-five kilograms of explosive for the payload's self-destruct system. It was a highly toxic explosion waiting to happen as more than 150 pad technicians stood in shock on trusses and girders all around the booster. Fortunately, not one of the pipes in any of the systems punctured.⁴³

Because the situation was so serious, Minister of General Machine Building Sergey A. Afanasyev headed up an emergency commission to save the pad, the booster, and the spacecraft. Afanasyev's First Deputy Tyulin supervised the general work of cutting the payload block to begin slowly pouring out propellants. Mishin personally directed all operations at the launch pad to separate, painfully and slowly, each component of the payload from the launch stack in the unbearably hot temperatures at the launch site. It took two weeks of concerted effort to finally dismantle the complex, based on thorough calculations on each component's center of

42. Semenov, ed., *Raketno-Kosmicheskaya Korporatsiya*, p. 242; Kamanin, "A Goal Worth Working for," no. 49.

43. Semenov, ed., *Raketno-Kosmicheskaya Korporatsiya*, pp. 242–43; Kamanin, "A Goal Worth Working for," no. 49.

gravity after the accident. Both the July and August lunar launch windows were abandoned as a result, reducing further the odds of a piloted circumlunar mission before the end of 1968. The best-case scenario was a December launch, although unofficially many engineers believed that January 1969 was a more realistic target. Maintaining this new deadline was complicated further by plans to concurrently run Soyuz missions in Earth orbit, which were indispensable to advancing the Soviet lunar *landing* program. Unlike the LI, however, the Soyuz had a less painful road back to recovery after the Komarov tragedy in 1967.

Docking in Orbit

In April 1967, when cosmonaut Komarov set off on his last mission, there were fairly distinct plans for at least two further Soyuz missions to follow. Both would have been solo Earth-orbital missions, the first (Soyuz 3) commanded by Gagarin and the second (Soyuz 4) commanded by rookie Beregovoy.⁴⁴ For Gagarin's career, the Soyuz 1 disaster was a severe setback. Having lost one of Soviet Union's best and brightest, cosmonaut overseer Lt. General Kamanin was not about to jeopardize Gagarin's life in grueling training programs. On April 29, 1967, five days after the accident, Kamanin met with a number of cosmonauts, including Gagarin. Beregovoy recalled that:

... Kamanin, who looked aged by the tragedy, called us all together and laid out the future flight programme. He told Gagarin straight out that there was practically no chance he would be allowed to fly again. Kamanin himself would recommend that Gagarin not be permitted to participate in any other flights. Yuri listened to this terrible pronouncement in silence.⁴⁵

The most immediate matter at hand for Kamanin was to reestablish a training plan for Soyuz, contingent upon a new schedule of flights set by Chief Designer Mishin. In revising the Soyuz manifest, all agreed that the first subsequent crewed mission should be a repeat attempt to carry out the aborted docking and EVA flight from Soyuz 1. By May 5, Kamanin had tapped test pilot Beregovoy to pilot the active vehicle. As plans stood at the time, the old Bykovskiy crew from Komarov's mission would remain as a team to fly the passive Soyuz spacecraft. They began training with the *Volga* rendezvous simulator by the fall of 1967.

Ironically, by the time that the Soyuz 1 disaster paralyzed the Soviet piloted space program, the cosmonaut corps was swelling to its greatest number. Traditionally, most cosmonaut trainees were military pilots or engineers. Mishin's insistence on including engineers from TsKBEM had forced the Air Force to accept civilians who had participated in the design of the Soyuz spacecraft. Although such a group of eight engineers had begun training in late 1966, they did not receive official status as "cosmonaut-testers" until an order of the Ministry of

44. E-mail correspondence, Sergey Voevodin to the author, January 30, 1997. At the time, the Soyuz 3 crew consisted of Yu. A. Gagarin/V. N. Volkov (primary) and A. G. Nikolayev/V. N. Kubasov (backup). The Soyuz 4 crew was G. T. Beregovoy/L. S. Demin/G. S. Shonin (primary) and D. A. Zaykin/A. N. Matinchenko/G. T. Dobrovolskiy (backup). See also V. Molchanov, "First Selection" (English title), *Apogee* 8 (March 1994): 2. In his diary entry dated December 7, 1966, N. P. Kamanin provides a slightly different crew composition. The Soyuz 3/4 crews would have been G. T. Beregovoy (Soyuz 3) and V. A. Shatalov/V. N. Volkov/O. G. Makarov (Soyuz-4). These would probably have been the backup crews for Soyuz 3/4. Kamanin also writes that Soyuz 5 would be commanded by one of Beregovoy, Bykovskiy, Gagarin, Komarov, Nikolayev, and Shatalov. The remaining two crewmembers would be one of four candidates: V. G. Fartushniy, P. I. Kolodin, Yu. N. Lapkin, and an unnamed engineer from TsKBEM. See N. P. Kamanin, *Skrytiy kosmos: kniga utoraia, 1964-1966gg* (Moscow: Infortekst IF, 1997), p. 420.

45. Georgi Beregovoi, "Not to Be Forgotten," in Viktor Mitroshenkov, ed., *Pioneers of Space* (Moscow: Progress Publishers, 1989), pp. 298-99; Mitroshenkov, *Zemlya pod nebom*, pp. 413-14.

Machine Building on May 27, 1968. Of the eleven men inducted at this time, ten were from TsKBEM and one, Vladimir C. Fartushniy, was a senior scientist at the Ye. O. Paton Institute for Electro-Welding based at Kiev.⁴⁶ His selection was primarily motivated by plans to carry out welding experiments in space, an idea that had originated as early as November 1964 when Korolev had instructed his deputies to draw up plans for the work. Paton Institute Director Academician Boris Ye. Paton was also very supportive of the project and had initiated the development of an instrument named *Vulkan* to allow Soyuz cosmonauts to carry out such experiments in space.⁴⁷

In addition to engineers, the Soviets, like NASA, also looked into the matter of training career scientists for future space missions. In January 1965, Academy of Sciences President Keldysh set in motion the process of selecting scientist-cosmonauts, despite the almost customary resistance from the Air Force on the issue. What little science had emerged in the early 1960s was only after much lobbying by numerous highly placed academicians. While science was a junior partner in the U.S. space program, in the Soviet Union, it was considered an irritation at best. After the formation of the academy's Institute of Space Research, many scientists expected an expansion of scientific activities in space, but judging by the number of scientific satellites launched as part of the Kosmos cover name, it seems that the situation had not changed much. The only major components of scientific research were the continuing projects to send automated probes to Mars and Venus, but these efforts were to a great degree motivated by competition with the United States. Roald Z. Sagdeyev, later the Director of the Institute of Space Research, summarized the situation as one in which "the guiding philosophy behind Soviet space launches reflected the interests of the space industry to the complete neglect of science per se."⁴⁸

In this climate, Keldysh sent the files of twenty-four scientists to the Air Force. Of them, the military allowed nineteen to undergo medical screening in September 1966. By November, only four passed the rigorous testing at the Air Force's Central Scientific-Research Aviation Hospital. Finally, on May 22, 1967, a month after Komarov's death, they arrived at the Cosmonaut Training Center to begin training. They were:

- Mars N. Fatkullin (twenty-eight years old)
- Rudolf A. Gulyayev (thirty-two)
- Ordinard P. Kolomiytsev (thirty-two)
- Valentin G. Yershov (thirty-nine)⁴⁹

These four men were joined by Georgiy P. Katys, the accomplished scientist who had been passed over for several Voskhod missions because of his "questionable" background. Of the four new scientists, Fatkullin, Gulyayev, and Kolimiytsev were all researchers from the academy's

46 I. Marinin, "The First Civilian Cosmonauts" (English title), *Novosti kosmonavtiki* 12-13 (June 3-30, 1996): 81-87. The other ten TsKBEM selectees were K. P. Feoktistov, C. M. Crechko, V. N. Kubasov, O. C. Makarov, V. I. Patsayev, N. N. Rukavishnikov, V. I. Sevastyanov, V. N. Volkov, V. A. Yazdovskiy, and A. S. Yeliseyev.

47 Korolev's letter to his deputies, dated November 29, 1964, has been published as S. P. Korolev, "On a Program of Work on Welding in Space Conditions" (English title), in M. V. Keldysh, ed., *Tvorcheskoye naslediyе Akademika Sergeya Pavliourcha Koroleva: izbrannyye trudy i dokumenty* (Moscow: Nauka, 1980), p. 520. For an account of a conversation between Korolev and Paton in the autumn of 1965 on the welding issue, see Aleksandr Romanov, *Korolev* (Moscow: Molodaya gvardiya, 1996), pp. 503-09. Korolev and Paton signed a formal agreement on the project on December 1, 1965.

48 Roald Z. Sagdeev, *The Making of a Soviet Scientist: My Adventures in Nuclear Fusion and Space From Stalin to Star Wars* (New York: John Wiley & Sons, 1993), p. 154.

49 I. Marinin, "Russian Cosmonaut-Scholars" (English title), *Novosti kosmonavtiki* 3 (January 28-February 11, 1996): 49-54; Kamanin, *Skrytiy kosmos: kniga utora, 1964-1966gg.* pp. 132, 204, 378, 382.

Institute of Terrestrial Magnetism, Ionosphere, and Radio Wave Propagation. while Yershov was from the famous Institute of Applied Mathematics, which Keldysh headed at the time. Yershov was chosen specifically to provide navigational support on LI circumlunar missions. He, in fact, participated in the development of the LI autonomous navigation system. By coincidence, NASA selected its second group of scientist astronauts a little more than two months after the Soviet selection. These eleven new astronauts would be unofficially known as the "Excess 11" to indicate their less than hopeful chances of ever making it into space." Under the command of Katys, the Soviet scientists finished their initial training program in July 1968 to await formal assignment to a flight.

Scientists were not the only civilians considered for spots on a Soviet spaceship. Decades before NASA considered sending a journalist into space, the late Korolev had given the idea some thought. One of those in the running was Yaroslav K. Golovanov, a writer for the newspaper *Komsomoiskaya pravda*, who would thirty years later publish a biography of Korolev. Colovanov, one of the few Soviet journalists allowed into the inner sanctum of the Soviet space program, had spoken to Korolev in January 1965 on the possibility of beginning cosmonaut training. On February 12, 1965, the chief designer signed papers permitting him to begin initial medical screening tests. He was joined by a second reporter, Yuriy V. Letunov of the TV program *Vremya* (Time). In July–August 1965, both passed their initial medical tests, but the journalist-in-space idea receded into the background after Korolev's death. Golovanov tried to pursue the matter with a letter to the Central Committee in the spring of 1968, but the space leadership politely rejected the idea, no doubt because the Soyuz at the time was still a raw, untested machine, better to be flown by experienced pilots.⁵

Declaring the Soyuz safe took a considerable amount of time. Based on the recommendations of the Utkin subcommission, engineers at TsKBEM, the Scientific-Research Institute for Automated Devices (responsible for designing parachutes), and the M. M. Gromov Flight-Research Institute carried out an intensive series of corrective tests on the Soyuz capsule throughout 1967. The tests resulted in some supplementary modifications to the Soyuz parachute system, including changes in the operations schedule of the reserve parachute during launch aborts up to six kilometers altitude. Engineers built several boilerplate models of the descent apparatus to test these modifications: the Utkin subcommission evidently had the authority to recommend changes in design.

The process to declaring the 7K-OK Soyuz vehicle safe for automated flight was fraught with difficulties and accidents. Two new Soyuz spacecraft were the subject of vigorous testing for an automated docking flight in the fall of 1967. During a ground test of the solar panels on one of them, electric equipment burnt out, forcing engineers to dismantle the ship and replace the damaged instruments. Of the twenty tests at the Air Force site at Feodosiya by late September 1967, nearly half had malfunctions; three were complete failures." Despite the setbacks, by the autumn of 1967, the Utkin subcommission declared the 7K-OK Soyuz vehicle safe for automated missions." Parachute testing would continue until commission members were satisfied that the complete system was safe for humans.

⁵⁰ For a discussion of the events and controversy behind the selection of scientist astronauts in the US space program see William David Compton *Where No Man Has Gone Before: A History of Lunar Exploration Missions* (Washington DC: NASA SP 4214, 1989) pp 57–58, 65–72. See also Donald K. "Deke" Slayton with Michael Cassutt *Deke! US Manned Space: From Mercury to the Shuttle* (New York: Forge, 1994) pp 143–44, 152–53 for a more personal account.

⁵¹ A. A. Tarasov *Neizvestniy kosmodrom* (Moscow: Orbita, 1990) pp 8–10.

⁵² Kamanin *A Goal Worth Working for* no 47.

⁵³ Semenov ed *Raketno Kosmicheskaya Korporatsiya* p 183.

The two Soyuz spacecraft finished their testing at the Baykonur Cosmodrome by mid-October 1967 and were prepared for launch soon after. On October 16, at a meeting of the State Commission, Mishin announced that the flight profile for the new launches would be slightly different than the one planned for the aborted Soyuz 1/2 mission. The primary goal of this test would be to check the reliability of all major spaceship systems of both spacecraft. The active Soyuz would spend almost three days flying solo in orbit, while controllers at Yevpatoriya would pore over incoming data. If the "health" of the ship was still acceptable, then the Strategic Missile Forces would launch the passive Soyuz at the end of the third day. The two spacecraft would merely approach each other in space using their Igla radar systems. Docking was not completely excluded from the plan, but it was not considered a primary goal. The first ground training simulation for the plan was held on October 19, with cosmonaut Gagarin participating as a member of the Chief Operations and Control Group. Later, he flew into Leninsk near the test site the day before the scheduled launch. Coincidentally, his Air Force boss Kamanin was promoted from lieutenant general to colonel general the same day.⁵⁴ For Kamanin, his rank was not the only good news of the week.

The active spacecraft, vehicle no 6, simulating the role of the lunar orbiter in the lunar landing mission, was launched successfully from site 31 at Tyura-Tam at 1230 hours Moscow Time on October 27, 1967. The initial orbital parameters of the spaceship, named *Kosmos-186* in the Soviet press, were announced as 209 by 235 kilometers at a 51.7-degree inclination. Naturally, TASS neglected to mention that the flight had any relation to the piloted space effort. For the first time in the Soyuz program, all systems were working without fault in orbit. The solar panels deployed, and the Igla system was operational." There was some sign of trouble on the second day of the mission when controllers discovered that the spacecraft was unable to change its orbit on the seventeenth orbit, apparently because of a malfunction in the 45K stellar-solar attitude control sensor. There were also disruptions in the work of the ion sensor system the following day. Engineers dug into their work and managed to overcome the most serious problems by the third day of the flight, prompting the State Commission to give a go-ahead for the second Soyuz launch.

Before the launch of the passive Soyuz, Mishin, perhaps motivated by the relatively good state of *Kosmos-186* in orbit, decided to attempt not just rendezvous, but full docking between the two vehicles.⁵⁶ Thus, with a new mission, the passive Soyuz, spacecraft no. 5, was launched at 1212 hours Moscow Time on October 30 and entered a 200- by 276-kilometer orbit, also at a 51.7-degree inclination. The vehicle was named *Kosmos-188* in the Soviet press. The performance of both vehicles fulfilled all expectations. The launch of the second spacecraft was performed in such a way as to insert the vehicle within twenty-four kilometers of the active ship. The latter then fired its engine twenty-eight times (over three minutes of burn time) on completely automatic commands from the Igla system. Within just sixty-two minutes of the launch of *Kosmos-188*, both vehicles were successfully docked to each other on the target's first orbit. At the time of docking, the two ships were out of communication range with Soviet surface tracking stations, but once they were over Soviet territory, ground controllers began receiving clear video pictures from the ships showing their docked configuration. These images

54. Mitroshenkov, *Zemlya pod nebom*, p. 425; B. Ye. Chertok, *Rakety i lyudi goryachiye dni kholodnoy uoyny* (Moscow: Mashinostroyeniye, 1997), pp. 467-69.

55. Kamanin, "A Coal Worth Working for," no. 47.

56. *Ibid.* Interestingly, Chief Designer A. S. Mnatsakanyan of the Scientific-Research Institute of Precision Instruments (NII TP), responsible for developing the Igla system, recalls that an unnamed deputy chairman of the Soyuz State Commission expressed reservations about going for a full docking only an hour before launch. Mnatsakanyan, however, gave his full support to Igla. See Yu. A. Mozzhorin, et al., eds. *Dorogi v kosmos II* (Moscow: MAI, 1992), p. 32.

were later shown on Soviet TV, giving the public their first brief look at the Soyuz spacecraft. It was an impressive display of automation, bolstering somewhat the argument that cosmonauts were mere passengers in the Soyuz spacecraft. It was also the first docking of two robot spaceships in history.

After the two ships were linked, the controllers discovered that there had not been full "hard" docking because, for reasons unknown, there was still an eighty-five-millimeter gap between the two ships. This was considered a minor problem, and after three and a half hours of connected operations over two and a half orbits, Kosmos-186 and Kosmos-188 separated. Both ships were to finish off their missions with guided reentries, but both ran into problems. In Kosmos-186's case, on October 31, the failure of the 45K sensor changed the reentry profile into a direct ballistic return. The descent apparatus, however, was recovered safely. The following day, Kosmos-188 was unable to perform a guided return because of incorrect attitude; the ship had flown into an ion pocket, confusing the ion attitude control sensor. The ship entered on a steep trajectory, and its self-contained explosive automatically destroyed the descent apparatus to prevent a landing on foreign territory. It was proved later that if the explosive had not been carried on board, the capsule would have landed 400 kilometers east of Ulan-Ude north of Mongolia, but in Soviet territory."

The Kosmos-186/188 flight was timed to occur a week before the fiftieth anniversary of the Great October Revolution. It was a poor substitute for a piloted circumlunar mission, but it was a minor advance for a space program beleaguered by failures and catastrophes. The confidence imparted by the docking mission was, however, tempered by the two unrelated L1 launch failures before and after Kosmos-186/188. Immediately after the docking success, the Soyuz State Commission met on November 15 to discuss the future manifest for the project.⁵⁷ With no authorization from the Utkin subcommission to carry out piloted flights, it seems that Mishin had planned a repeat performance of the automated docking mission in early 1968, which would allow further testing of the problematic attitude control sensors on the Soyuz spacecraft. In the meantime, crews training for upcoming Soyuz flights continued their training program at a less intensive pace.

For "Cosmonaut No. 1." Yuriy A. Gagarin, the post-Soyuz 1 period was a particularly transitional time. Having been denied flight status, in November 1967, he was subjected to the additional humiliation of being grounded from flying aircraft solo. Apart from his important role in various State Commissions, he continued to serve as an international ambassador for the Soviet space program. His various obligations took their toll. Kamanin wrote in his journals in 1968:

There were many situations when Gagarin miraculously escaped big troubles. These situations often occurred when he attended parties, drove in cars or boats, or when hunting with the big bosses. I was particularly concerned about his driving cars at high speeds. I did a lot of talking with Yura on this issue. The active life style, endless meetings and drinking sessions were noticeably changing Yura's image and slowly, but steadily erasing his charming smile from his face."

Training for the Soyuz 1 flight and an assignment to the subsequent Soyuz 3 mission apparently curbed his extracurricular activities. The cosmonaut lost weight, trained regularly, and eventually mastered the Soyuz spacecraft. In addition, by late 1967, he was finally wrapping up work on his graduate degree at the N. Ye. Zhukovskiy Military-Air Engineering

57 Chertok *Rakety i lyudi goryochiye dni kholodnoy voyny* pp 473-74

58 Mitroshenkov, *Zemlya pod nebom* p 425

59 N. Kamanin "For Him Living Meant Flying" (English title) *Vozdushniy transport* 11 (1994) 13

Academy in Moscow dealing with a reusable single-seat military spaceplane. At Cagarin's own request, Kamanin temporarily relieved the young cosmonaut of his duties as training center deputy director to allow him to focus exclusively on his dissertation. At the same time, Kamanin and Center Director Maj. General Nikolay F. Kuznetsov promised Cagarin that he would be allowed to resume flight training once his academic work was finished."

On January 8, 1968, several of the fifteen cosmonauts pursuing higher degrees graduated with their "Candidate of Technical Sciences." Gagarin and Titov defended their dissertations on February 17 at the academy, and both passed with excellent grades." Immediately afterwards, Cagarin threw himself back into flying in training aircraft to gain enough experience to resume flying solo. After passing his medical tests on March 12, he was cleared to fly, and he did so jointly with another pilot the following day for a one-hour, fifty-two-minute jaunt. He flew several times the following days, always with other more experienced pilots who kept their hands on the controls. On March 23, Kamanin expressed some reservations about Cagarin's frenzied training pace, but could not dampen the cosmonaut's enthusiasm.⁶²

On his flight on March 27, Gagarin was escorted by Colonel Vladimir S. Seregin, a forty-five-year-old test pilot with impeccable credentials, who had been assisting flight training for cosmonauts since 1963. The two took off from the Chkalovskaya airfield near Moscow a little after 10 a.m. in the morning for a flight over the town of Kirzhach. A few minutes after takeoff, Cagarin requested permission to alter course: "This is 625. Mission accomplished. Altitude 5,200. Request permission to approach." It was the last communication from the UTI-MiG-15 trainer aircraft. Communications abruptly ended at 1030 hours, 10 seconds Moscow Time. As alarm began to rise back at the Cosmonaut Training Center, Air Force officials put together a search team to determine the fate of the two men. About four hours and twenty minutes after loss of contact, a helicopter commander finally reported back that he had found the wreckage of the airplane about sixty-four kilometers from the airfield. Debris was scattered in a very woody area, with snow as much as one meter deep. The engine and the cockpit were evidently buried six to seven meters in the ground, indicating that the plane had hit the ground at a velocity of 700 to 800 kilometers per hour. It was not long before searchers found a fragment of an upper jaw, which doctors identified as belonging to Seregin. Air Force officials immediately informed Soviet leaders Brezhnev and Kosygin of Seregin's fate, although they had no incontrovertible proof of Gagarin's death.⁶⁴

Throughout the night, an emergency commission held meetings to establish what had happened. It was a long torturous night for many, as it was becoming increasingly clear that there was almost no chance that Cagarin had survived. One cosmonaut recalled, "We saw Kamanin with his lips pressed tightly together. Kuznetsov struggling to control his trembling chin, Leonov with his face to the wall and Popovich repeatedly leafing through flight documents." As soon as dawn broke on March 28, a search party led by Kamanin was back

60. The letter requesting that Gagarin be relieved of his duties as deputy commander of military unit no. 26266 (the Cosmonaut Training Center) and the letter permitting him solo flying privileges in the spring and summer of 1968 have been published in Kamanin, "For Him, Living Meant Flying," no. 9.

61. Among the cosmonauts defending in January were V. F. Bykovskiy, V. V. Gorbatko, A. G. Nikolayev, P. R. Popovich, G. S. Shonin, and B. V. Volynov. See Mitroshenkov, *Zemlya pod nebom*, p. 429. Others who graduated in 1968 were A. A. Leonov, Ye. V. Khrunov, I. B. Solovyeva, and D. A. Zaykin. The three remaining cosmonauts of the group of fifteen—all women—graduated in 1969.

62. Mitroshenkov, *Zemlya pod nebom*, pp. 437–41. Gagarin's wife recalls of this period: "He talked about another spaceflight and began to train for it." See Yevgeniya Malakohovskaya, "Tell Me About Him," in Mitroshenkov, ed., *Pioneers of Space*, pp. 147.

63. Beregovoi, "Not to Be Forgotten," p. 320.

64. Kamanin, "For Him, Living Meant Flying," no. 9.

65. Beregovoi, "Not to Be Forgotten," p. 318.

at the crash site. At around 8 a.m., Kamanin saw a piece of cloth hanging from a birch tree about ten to twelve meters in the air; the cloth was identified conclusively as a piece of Gagarin's flight jacket. By then there was no doubt: Gagarin was dead. Both pilots' bodies were found soon after. Gagarin's wallet contained his ID, a driver's license, 74 rubles, and small photo of Sergey P. Korolev. Both bodies were cremated by 2115 hours the same night. In contrast to the deaths of Korolev and Komarov, the outpouring of grief from the average Soviet citizen was unprecedented. The urns with the two pilots' ashes were laid at the Central House of the Soviet Army the following day for 40,000 people to pay their respects. On March 30, the urns of Gagarin and Seregin were escorted by Soviet leaders Brezhnev, Kosygin, Podgorniy, and others to the Kremlin Wall to be interred in their final place. Hundreds of thousands of Muscovites were on hand to view the dour funeral march for a man they considered a fallen national hero.⁶⁶

The investigation commission into the disaster discerned a cause of the accident by late July 1968, although it was a process fraught with diverging opinions because of the absence of "a smoking gun" despite the thousands of hours spent poring over the evidence. The official report, issued in December 1968 by the Central Committee, hinted at pilot error:

The most probable cause of the death of Gagarin and Seregin was a sudden turn of the aircraft to avoid a collision with a sounding balloon; a less probable cause was turning of the aircraft from the upper edge of the clouds. As a result of the sudden turn, the airplane entered critical flying angles; the adverse meteorological situation complicated aircraft control; and the crew died."

Both the senior cosmonauts and Kamanin seem to have objected vigorously to attributing the accident to pilot error; they even sent a letter to Central Committee Secretary Ustinov on the issue. On the other side, many of the Air Force members investigating the accident were evidently reluctant to admit that there were defects in the UTI-MiG-15 aircraft.

Almost twenty years later, the files for the crash were reopened, and a number of researchers carried out a detailed investigation using computer modeling to determine the causes of the crash. The new study found that the accident did not occur because of pilot error or from a mid-air collision. There were a number of cumulative causes. Ground equipment was evidently faulty at the time of the accident and thus was unable to track the UTI-MiG-15 in flight. In addition, Gagarin and Seregin did not have accurate information regarding the altitude of the ceiling in that area. Other violations of safety regulations included the flight of two MiG-21s and a MiG-15 in the same area at the same time. As for Gagarin and Seregin, after receiving their last instruction to fly home, they began a turn and descent to 700-1200 meters. At that time, they were flying between two layers of clouds and could not see the horizon. The other MiG-15 then passed Gagarin's plane at a distance of only 500 meters, although the pilot of the other craft did not notice Gagarin's aircraft. Soon after, Gagarin's plane entered a trailing vortex created by the second MiG and flew into a spin. Gagarin and Seregin managed to pull out of the spin after five full revolutions but only in thick cloud cover, which disoriented the pilots. They overestimated their altitude by 200-300 meters and exited the cloud cover assuming their altitude was much higher than the actual 400-600 meters above the ground. Their angle of attack at the time was seventy degrees. The pilots were unable to activate the emergency ejection system in the less

66 Kamanin "For Him Living Meant Flying," no. 9

67 N. Kamanin, "For Him Living Meant Flying" (English title) *Vozdushniy transport* 18-19 (1994) 12

than five seconds remaining and crashed into the ground. An extra two seconds or 250–300 meters altitude would have easily saved them."

Clearing the Soyuz

Gagarin's death was an unprecedented psychological blow to the Soviets, especially because it came at a time when the Soviet piloted space program was reaching a nadir of sorts—a situation that no one could have anticipated a few years before. From the days of consecutive victories in the early 1960s, the Soviets witnessed an almost unending series of setbacks, tragedies, and failures. Perhaps the only bright spot in the quagmire was the recent successful docking-in-Earth-orbit Soyuz flight in October 1967. Since then, tests had continued slowly on the parachute and landing systems of the 7K-OK vehicle in preparation for a repeat attempt of the original Soyuz I mission. There were, however, a number of landing failures that progressively delayed plans—malfunctions that in retrospect were critical in moving piloted Soyuz flights downrange at a time when NASA was beginning to finally recover from the Apollo I disaster. The State Commission for Soyuz, under Lt. General Kerim A. Kerimov, met on March 26, 1968, the day before Gagarin's death, to discuss immediate plans. Mishin and Chief Designer Fedor D. Tkachev of the Scientific-Research Institute of Automated Devices, which was responsible for parachute design, reported that the 7K-OK ship's primary parachute system was already cleared for flight while the reserve system would be ready by launch time, then set for April 9–14.⁶⁸

On April 10, exactly two weeks after Gagarin's death, several cosmonauts, including rookie Beregovoy, slated to command the Soyuz I repeat docking flight, flew to the Baykonur Cosmodrome accompanied by Air Force First Deputy Commander-in-Chief Marshal Sergey I. Rudenko. Many officials remained in Moscow, because of the investigation into the causes of Gagarin's death and also to celebrate April 12 or "Cosmonautics Day," the seventh anniversary of Gagarin's pioneering first flight. After arrival at Tyura-Tam, the State Commission set the two Soyuz launches for 14 and 15 April. Unlike the Kosmos-1861188 mission, this particular joint flight was to simulate an actual piloted flight as closely as possible. Consequently, the primary and backup crews training for the docking and EVA mission were sent to the Flight Control Center at Yevpatoriya to follow the flight on the ground and train in such a manner as to simulate their actions on a real mission. Both ships were also equipped with new infrared attitude control sensors to augment the chronically faulty ionic sensor system on the early Soyuz spacecraft."

The active 7K-OK vehicle, spacecraft no. 8, was launched from Tyura-Tam at 1300 hours Moscow Time on April 14, 1968. Initial orbital parameters were 210 by 239 kilometers at a 51.7-degree inclination. The Soviet press announced the mission as Kosmos-212. A day later, on April 15, engineers successfully launched the passive Soyuz spacecraft, vehicle no. 7, at 1234 hours Moscow Time, with only a two-second delay. The target vehicle, named Kosmos-213, entered an initial orbit of 205 by 291 kilometers at a 51.4-degree inclination. At the point of orbital insertion, the active spacecraft was only four kilometers away from the passive one, a remarkable achievement in precision. With great economy of propellant, Kosmos-212 approached Kosmos-213 and automatically docked at 1331 hours, just fifty-seven

68 S. Belotserkovskiy and A. Leonov. "Two Seconds Was All They Needed—Yu. Gagarin and V. Seregin's Final Flight" (English title). *Pravda*. March 23, 1988, p. 4. As remarkable as it may seem, an entire book has been dedicated to Gagarin's death and the new investigation in 1987–88. See S. M. Belotserkovskiy. *Gibel Gagarina fakty i domysly* (Moscow: Mashinostroyeniya, 1992).

69 Kamanin. "For Him, Living Meant Flying," no. 9.

70 Kamanin. "For Him, Living Meant Flying," no. 12.

minutes after the target spacecraft's launch. Ground controllers at Yevpatoriya were able to view the docking on their consoles via a live TV feed from both spacecraft. The two spacecraft remained connected for three hours and fifty minutes before continuing autonomous flight: each vehicle clocked up about five days in space. The major remaining objective of the flight was to verify the complete reentry procedure. Kosmos-212 successfully carried out the first guided reentry in the Soyuz program (with an aerodynamic efficiency ratio of 0.3) and landed near Karaganda in Kazakhstan on April 19. Winds were very high at the landing site, up to twenty-two to twenty-three meters per second, and although the descent apparatus landed safely, winds dragged the capsule about five kilometers from its landing spot, damaging the outside coating."

Kosmos-213 remained in orbit for another day and conducted some unusual scientific experiments. On board the spacecraft was an extensive scientific payload, including a new type of luminescent micrometeoroid detector, an ultraviolet photometer, and a radiation-sensing package. The photometer measured ultraviolet and visual spectrographic night sky brightness, while the *Luch-1* instrument measured cosmic ray positrons and electrons. In addition, a cryogenic superconducting magnet, first tested on the Kosmos-140 Soyuz precursor, was used to detect cosmic rays in conjunction with scintillation, gas discharge, and Cherenkov detectors. The spacecraft's descent apparatus landed on April 20 near Tselinograd after another guided reentry. All systems worked without fault, but once again the descent apparatus was dragged after touchdown by twenty-five-meter-per-second wind speeds. Rescuers had to wait for the dust storm to subside before they could recover the capsule."

The successful conclusion of two consecutive automated docking missions raised the question of moving on with piloted flights. One of the biggest factors were the results of ongoing ground testing of the redesigned parachute system. Throughout 1967-68, engineers carried out a series of approximately forty drop tests of mock-ups of the descent apparatus from Tu-16 aircraft to verify the parachutes and elements of its design. In addition, they also conducted six test drops from An-12 aircraft and carried out special "controlled" experiments using Mi-6 helicopters by introducing a maximum of eighteen-meter-per-second *horizontal* velocity during the drops. There were a number of major failures, especially in the operation of the reserve parachute." The cosmonauts training for the docking and EVA mission completed their full training program by the end of May 1968, after many delays related to updating the Soyuz simulators concurrently with the actual Soyuz spacecraft. By February, Kamanin had tentatively tapped Beregovoy to command the active vehicle, and Volynov, Khrunov, and Yeliseyev to fly the passive vehicle, although as with many other earlier crews, the process of crew selection was caught up in an almost pointless conflict between Kamanin and Mishin.⁷⁴

71 *ibid*

72 *ibid* Joel Powell 'Research From Soviet Satellites' *Spaceflight* 25 (January 1983) 33-34

73 Semenov ed *Raketno Kosmicheskaya Korporatsiya* p 183 The testing was a joint effort among TsKBEM the M. M. Gromov Flight Research Institute the Scientific Research Institute for Automated Devices (NII AU) the Zvezda Design Bureau (KB Zvezda) and the Iskra Design Bureau (KB Iskra) and was carried out at the Air Forces testing station at Feodosiya

74 The center of this disagreement was over Mishin's insistence that TsKBEM Department Deputy Chief K. P. Feoktistov, a civilian, be included as the crew commander of the first post-Soyuz 1 flight. Feoktistov himself eagerly supported this position and took great pains in 1967-68 to promote his candidacy despite his relatively poor health and reluctance to commit to parachute training. The issue culminated in March 1968 during several State Commission meetings when the Air Force, led by Marshal S. I. Rudenko and Col. General N. P. Kamanin, resisted Mishin, Feoktistov, and their highly placed supporters in the government, which included M. V. Keldysh (AN SSSR), G. N. Pashkov (VPK), G. A. Tyulin (MOM), K. A. Kerimov (MOM), and B. A. Stroganov (TsK Defense Industries Department). It was not until mid-June 1968 when Mishin finally withdrew Feoktistov's candidacy. See also Beregovoi 'Not to Be Forgotten' p. 299

It was not until May 6, 1968, that the Council of Ministers formally approved the above crews. An additional four cosmonauts—Nikolayev, Shonin, Kubasov, and Corbatko—would fly an exact repeat of the docking and EVA mission at a later date.

The debate over the next step after the Kosmos-212/213 missions was colored to a great degree by Central Committee Secretary Ustinov's pronouncement before the docking flight in early April 1968 that "irrespective of the results of the upcoming flights of two Soyuz spaceships, two more spacecraft should be prepared for an experimental flight."⁷⁵ After the success of the Kosmos-212/213 mission, Ustinov's decision was called into question by other space program officials, including Mishin and Kamanin, who were more confident of the Soyuz spaceship's safety. On April 21, the day after Kosmos-213's landing, the State Commission met in Moscow; Commission Chairman Kerimov and Chief Designer Mishin graciously allowed the cosmonauts' views to be aired on the issue. All four primary crew cosmonauts favored a piloted flight as the next step. Kerimov, Mishin, Chertok, and others thanked the cosmonauts for their work and seem to have been very pleased that they supported a piloted mission. At least tentatively, Kerimov and Mishin scheduled the flight for late June or early July 1968.

Those advocating another automated mission were a powerful lobby—that is, the leaders of the Soviet military-industrial complex—Ustinov, Afanasyev, Smirnov, and Dementyev—all of whom were clearly playing it safe after the Komarov tragedy. Their viewpoint had some basis because by early May, although all the major problems with the 7K-OK spacecraft had been eliminated, it still had two weak spots: the backup parachute and the emergency rescue system. Throughout the twenty-three drop tests after Soyuz 1, the backup parachute had evidently performed below par, while the rescue system malfunctioned more frequently. Kamanin wrote in his diary about the dilemma facing the managers of the Soviet space program:

... under the circumstances Korolev would have assumed responsibility and given a go-ahead for the flight. Cosmonauts and Air force specialists would have gone along with such a decision. But unfortunately, Mishin is not Korolev and he is hedging: "I am not going to propose a manned flight myself, but if the Central Committee tells me to, I will agree."⁷⁶

The climate had clearly changed after the Soyuz 1 disaster. Kerimov and Mishin were definitely more conservative with their decisions. No one, from Ustinov down to Mishin, was gutsy enough to recommend a decision for flight and risk losing their jobs over a hasty decision. The decision would have important implications and, in retrospect, was a critical juncture in the Soviet space program. By mid-1968, NASA had meticulously modified its Apollo Command and Service Module and was close to declaring the spacecraft ready for piloted flight. Every month was desperately important as the two countries were closing in on their final goals. For the Soviets, including another automated mission would add yet another two months before they saw a return to piloted flight. For many, apart from the issue of safety, there were also exogenous considerations.

On May 7, 1968, Mishin held a meeting at TsKBEM in Kaliningrad. The engineers concluded at the end of the meeting that with the exception of the backup parachute system, the 7K-OK spacecraft was completely ready for piloted flight. Mishin believed that the parachute system would be cleared for flight by the first half of August. Troubles with the backup parachute system, however, forced Mishin and his deputies to rethink their strategies for an early August

75. Kamanin, "For Him, Living Meant Flying," no. 12.

76. *Ibid.*, p. 12.

flight. The major problem with the backup parachute was that with three crewmembers in the descent apparatus (an excess of 1,300 kilograms), it had a tendency to rip off upon deployment. Parachute Chief Designer Tkachev and Mishin proposed instead to reduce to the crew of the passive vehicle to two men, by 150-200 kilograms, to declare the system safe for operation. In addition, perhaps to avoid any unnecessary risk. Mishin proposed that during the August flight, the cosmonauts would dock the two Soyuz ships and only depressurize the living compartment of the passive Soyuz. In the interest of time, most of the cosmonauts as well as Kamanin agreed, at least tentatively, to the deletion of the spacewalk, leaving the more complex EVA transfer to a subsequent Soyuz mission.⁷⁷

The uncertainty with the backup parachute system, combined with a general sense of conservatism, introduced a modicum of uncertainty throughout the month of May 1968 as different engineers proposed different variants of the flight. Some supported having one member transfer via EVA from one ship to the other, while others suggested merely having one cosmonaut from the passive ship carry out an EVA without transfer. Another controversial issue was the number of crewmembers on each ship: several different combinations were considered at the time, including one on the active ship and two on the passive one, one on the active ship and three on the passive one, and two on both ships.

The group supporting an early return to piloted flight expanded by mid-May 1968, with the addition of Chief Designers Voronin and Severin. Academy of Sciences President Keldysh dissented, however, clearly still influenced by Soyuz 1. He cautioned, "It seems to me that we are too hasty, and the question of technological launchings should still be discussed. I reserve my opinion on the selection of piloted flights without preliminary additional technological [that is, robotic] launchings."⁷⁸

The issue seemed to reach some kind of resolution on May 29 at a meeting of the Council of Chief Designers. Pressured by Ustinov, Keldysh, and Smirnov, Mishin proposed a compromise variant for the initial Soyuz piloted flight: a docking of two 7K-OK vehicles in Earth orbit with a single cosmonaut in the active vehicle. At least a dozen other chief designers supported Mishin, and the Air Force agreed to the new proposal.⁷⁹ "A second flight in September would have the full docking plus EVA mission with cosmonauts Khrunov and Yeliseyev performing the critical transfer spacewalk. With the support of Minister of General Machine Building Afanasyev, this plan seemed to be the most promising, but, within a few days, the imposing hand of the Communist Party's Central Committee intervened. In early June, Ustinov blocked the proposal, giving orders that regardless of what the chief designers believed, another automated docking flight of the Soyuz was required before a piloted flight. With that final blow, the Soviet space program lost two critical months.

On June 10, 1968, the Soyuz State Commission met to discuss a response to Ustinov's demands. Commission Chairman Kerimov approved a plan to launch a single automated Soyuz

77 N Kamanin 'For Him Living Meant Flying' (English title) *Vozdushniy transport* 15 (1994) 11. According to Mishin the crews for the two Soyuz spacecraft would be Beregovoy/Kubasov (Soyuz 2) and Yeliseyev/Khrunov (Soyuz 3). Kamanin did not agree to Mishin's crew proposals and continued to resist efforts to posit a civilian (Yeliseyev) as a crew commander.

78 *Ibid*

79 Among the chief designers and other officials present at this meeting were V. P. Barmin (Chief Designer KB OM), V. P. Glushko (Chief Designer KB Energomash), Maj. General A. G. Karas (Commander TsUKOS), M. V. Keldysh (President AN SSSR), K. A. Kerimov (Chief Third Chief Directorate MOM), V. I. Kuznetsov (Chief Designer NII PM), V. P. Mishin (Chief Designer TsKBEM), N. A. Pilyugin (Chief Designer NII AP), M. S. Ryazanskiy (Chief Designer NII Priborostroyeniya), G. I. Severin (Chief Designer KB Zvezda), F. D. Tkachev (Chief Designer NII AU), G. A. Tyulin (First Deputy Minister MOM), I. I. Utkin (Chief Designer NII IT), and G. I. Voronin (Chief Designer KB Nauka).

vehicle in July, carry out a joint docking flight between two Soyuz spacecraft with a single cosmonaut in the active vehicle in September, and finally a full-scale docking and EVA mission in November–December 1968. The Military-Industrial Commission formally approved this plan in late July 1968. Ustinov had one more demand: that the third flight include a transfer of two cosmonauts from one vehicle to the other. This meant that Mishin and his engineers would have to come up with a solution to the reserve parachute problem before the end of the year. Because they could not reduce the mass of the reentry capsule below 2.750 kilograms (a low limit for three cosmonauts), the engineers had to search for other options to reinforce the reserve parachute system.⁸⁰

The robot 7K-OK spacecraft no. 9, was launched into orbit at 1300 hours Moscow Time on August 28, 1968, more than a month behind schedule because of a variety of problems related to the vehicle's parachute system. The spacecraft, named Kosmos-238 by the Soviet press, entered an initial orbit of 199 by 219 kilometers at a 51.7-degree inclination. The vehicle was a passive variant of the Soyuz spacecraft. Little is known about the mission, although Western observers tracked at least one major orbital maneuver during its flight.⁸¹ The descent apparatus returned to Earth without any significant anomalies on September 1, after a flight lasting one hour short of four days. Ustinov was satisfied, and the path was finally clear for piloted Soyuz missions after a break of close to one and a half years. This last flight, Kosmos-238, was critical not only because it finally instilled sufficient confidence for resuming crewed operations, but also because of the widespread importance of the 7K-OK spacecraft. The viability of almost all Soviet piloted space projects of the period, including the L1, the L3, the Soyuz, and the military 7K-VI, depended very much on the success and health of the 7K-OK vehicle. As evidenced by later declassified materials, the 7K-VI military reconnaissance offshoot of the Soyuz was suffering some major birth pains at the very same time that Mishin and his associates were trying to bring the Soyuz spacecraft back into crewed operations.

The Soyuz-VI

Looking back at the history of Soviet piloted space programs in the 1960s, what is most surprising is the unprecedented amount of work that was invested into projects that never saw the light of day. What the public saw at the time was only the tip of a supremely diverse space program; many projects were canceled prior to reaching flight status. In some cases, programs emerged and disappeared within the same year, inexplicably changing the direction of the Soviet space effort for a few months. One such program was the Zvezda military spaceship project, which had emerged in 1966–67 at TsKBEM's Branch No. 3 at Kuybyshev under the leadership of First Deputy Chief Designer Kozlov. Consisting of a completely redesigned Soyuz spacecraft named the 7K-VI, the vehicle was to provide military cosmonauts experience in activities such as reconnaissance and combat prior to the advent of the large Almaz space station in the late 1960s. By late 1967, Kozlov's immediate boss, Chief Designer Mishin, was evidently having second thoughts. For reasons that are not completely clear, Mishin countered with a new military station proposal at the time—one that would supersede Kozlov's Zvezda and in fact serve as a direct competitor to Chelomey's ambitious Almaz space station project, which had already received full support.

The situation was complicated by the relationship between the central headquarters of TsKBEM and its Branch No. 3. Although the latter reported nominally to Mishin, the branch

80. Kamanin, "For Him, Living Meant Flying," no. 16; N. Kamanin, "For Him, Living Meant Flying" (English title), *Vozdushnyi transport* 17 (1994): 11.

81. Phillip Clark, *The Soviet Manned Space Program. An Illustrated History of the Men, the Missions, and the Spacecraft* (New York: Orron, 1988), pp. 48–49.

seems to have had some degree of autonomy with regard to its own programs. For example, in developing newer military photo-reconnaissance satellites such as Zenit-2M, Zenit-4M, and Yantar-2K, Kozlov's engineers for the most part worked without much interaction with Mishin's engineers. At the same time, Kozlov, as the organization's First Deputy Chief Designer, ultimately reported to Mishin on the progress of all his projects.

In October 1967, Mishin wrote a letter to Military-Industrial Commission Chairman Smirnov and Minister of General Machine Building Afanasyev to terminate Kozlov's 7K-VI program and use the freed-up resources to build an additional eight to ten Soyuz ships during the following year. Air Force Lt. General Kamanin, who clearly disliked Mishin both personally and professionally, wrote in his journal at the time:

Work on developing the [7K-VI] ship is in full swing and it promises to be much better than the Soyuz. This is apparently exactly the thing that is tormenting Mishin. He didn't have anything against 7K-VI as long as he counted on the fact that it would be an exact replica of the Soyuz, but when he saw that Kozlov had refrained from blindly copying Soyuz and was developing a principally new and significantly better ship, he abruptly changed his opinion of Kozlov and his ship.⁸²

Although recent accounts of the history of the 7K-VI portray Mishin as the "evil" figure in the attack against the vehicle, it is clear that he had the strong support of most of his leading deputies on the matter. Their criticism of Kozlov's spaceship centered on two factors—the use of radio-isotope generators and the use of a hatch in the heat shield—both of which they considered very weak design choices.

As an alternative to the 7K-VI, Mishin and his deputies instead proposed a new concept, the Orbital Research Station, better known simply as the *Soyuz-VI*, with the "VI" being the abbreviation in Russian for "military research." Within a few weeks of the new proposal, Kozlov capitulated to Mishin's new proposal, evidently because of intense pressure from Minister Afanasyev, and abandoned his coveted Zvezda project. In November 1967, Mishin and Kozlov signed a document titled "Basic Provisions for the Development of the Soyuz-VI Military-Research Space Complex," which officially testified to Kozlov's capitulation to Mishin on the matter." Kozlov's abrupt change of direction put the military in the difficult position of having to support a program whose chief designer was no longer interested in it. In this climate, many military officers, including Commander of the Central Directorate of Space Assets Lt. General Andrey G. Karas, who had invested much time and resources in Zvezda, consolidated their forces to put up a resistance against Mishin's new Soyuz-VI. The standoff came to a head on December 8, 1967, at a meeting on the premises of TsKBEM. Mishin was on vacation at the time, and Kerim A. Kerimov, the Chief of the Third Chief Directorate of the Ministry of General Machine Building, presided over the deliberations. All of the leading deputy chief designers at TsKBEM, including Bushuyev, Chertok, and Okhapkin, came out in favor of terminating Zvezda. Predictably, most of the military officers were against it, raising a particularly relevant question: "Why do we need a small Almaz if we're already building a big one?"⁸⁴

It seems that the Mishin faction had lined up its ducks in a row. By instructions from Minister of General Machine Building Afanasyev, on January 9, 1968, Kozlov signed an order

82 K. Lantratov. "Dmitriy Kozlov's 'Zvezda'" (English title). *Novosti kosmonautiki* 6 (March 10–23, 1997), 74–80. Translation by Bart Hendrickx.

83 Semenov, ed.. *Raketno-Kosmicheskaya Korporatsiya*. p. 210. Mishin met with Kozlov on October 12, 1967, to discuss the cancellation of the Zvezda project.

84. Lantratov. "Dmitriy Kozlov's 'Zvezda'", Kamanin. "A Coal Worth Working for," no. 48.

terminating all work on the Zvezda spacecraft to commence developmental work in support of Mishin's Soyuz-VI. The military did not give up. On January 27, Kamanin enlisted the support of six veteran cosmonauts and met with USSR First Deputy Minister of Defense Marshal Ivan I. Yakubovskiy, who promised to assist on the matter. The disagreement finally came to some kind of resolution on February 17, 1968, during a meeting of the Scientific-Technical Committee of the General Staff of the Ministry of Defense, the authoritative consultative body for all new military programs in the country. Chaired by Committee Chairman Col. General Nikolay N. Alekseyev, the meeting was called to discuss the joint proposal of Mishin and Kozlov to terminate Zvezda in favor of Soyuz-VI. Although all the attending high-ranking officers came out in favor of continuing with Zvezda, it was becoming increasingly difficult for them to offer support to the project when Kozlov himself had changed sides. In addition, the military's word on the issue may have been overruled by someone in the Communist Party's Central Committee. With little hope for victory, Alekseyev essentially dropped the matter, effectively closing the Zvezda program. Although Kozlov was shut out as a "prime contractor" in the piloted space program, he was able to use many of the basic systems from the Zvezda space complex to develop subsequent automated reconnaissance satellites in the Yantar ("Amber") series.⁸⁵

The new Soyuz-VI program was clearly a competitor of sorts to Chelomey's Almaz, and therein may lie the answer to how Mishin was able to gain support for his project in the face of such imposing resistance from the military. Central Committee Secretary Ustinov, the *de facto* head of the Soviet space program, was known as being extremely hostile to Chelomey's ambitions. By supporting Soyuz-VI, he may have been trying to sabotage Chelomey's Almaz.

The Soyuz-VI complex consisted of a small space station, named the orbital block (OB-VI) and a crew delivery spacecraft (7K-S), which was to be developed on the basis of the original 7K-OK Soyuz spacecraft. Augmenting the entire Soyuz-VI complex would be three other spacecraft: two Soyuz-type ships for short- and long-duration independent missions (7K-S-I and 7K-S-II, respectively) and a robot cargo ship (7K-G), which was also a modification of the basic Soyuz spacecraft.⁸⁶

Very little is known about the station proper of the Soyuz-VI complex: it was apparently very similar to the orbital block of the long-abandoned Soyuz-R project from the mid-1960s (that is, shaped like a cylinder about the size of a 7K-OK spacecraft). The OB-VI was to carry about 700 to 1,000 kilograms of scientific and military apparatus. Instead of radio-isotope generators to provide power as on the Zvezda, the OB-VI had solar panels. One of the requirements of the Soyuz-VI's design was that it allow cosmonauts to transfer from a ferry to the station via internal means. Thus, unlike the regular 7K-OK Soyuz vehicle, which had a system that prevented internal transfer, Mishin's engineers for the first time began work on a more flexible pin-cone system to allow through passage. Like much of the station, this system was also evidently based on the earlier Soyuz-R concept. The Soyuz-VI complex was to fly in an operational orbit of 250 by 270 kilometers at an inclination of 5.16 degrees. Piloted flights would last approximately thirty days." For a brief period, Mishin evidently considered the idea of testing advanced particle accelerators on the Soyuz-VI complex. In June 1968, representatives of TsKBEM met with famous Soviet physicist Andrey I. Budker, one of the founders of the Institute of Nuclear Physics, to discuss the issue. The idea was probably dropped soon after because of the limited capabilities of the Soyuz-VI.

85 Lantratov. "Dmitriy Kozlov's 'Zvezda' "

86 *Ibid* The production designations for these spacecraft were, the complete Soyuz-VI complex (11F730), the OB-VI (11F731), the 7K-S (11F732), the 7K-S-I (11F733), the 7K-S-II (11F734), and the 7K-C (11F735).

87 Semenov, ed. *Raketno-Kosmicheskaya Korporatsiya*, p. 210.

The 7K-S crew supply ship was an improved version of the basic 7K-OK Soyuz vehicle. Under Mishin's direction, engineers addressed all the weak points of the original Soyuz ship and tried to replace systems and eliminate shortcomings. The official design bureau history adds that:

. . . with the goal of improving the tactical-technical, technological, and operational characteristics in the ship's design and on-board systems, important changes were introduced, which affected the course of development and ultimately resulted in the creation of a new ship.⁸⁸

When work began on the Soyuz-VI in the second half of 1967, it was overseen by Deputy Chief Designers Bushuyev and Tsybin; both men were principally responsible for piloted space-ships at the organization. The USSR Ministry of Defense issued a new tactical-technical requirement for the Soyuz-VI complex in May 1968, which supplemented a similar document issued in support of the canceled Zvezda. A month later, on June 21, amid the intense preparations for piloted lunar flights. TsKBEM and its Branch No. 3, jointly issued the first version of the draft plan for the Soyuz-VI. Mishin subsequently approved the "theoretical drawings" of the 7K-S Soyuz spaceship on October 14, 1968.⁸⁹ As part of the general change in direction from Zvezda to Soyuz-VI, many of the cosmonauts training for the former were reassigned to the latter. The group was originally commanded by veteran Popovich, but upon his transfer to the lunar program, he was replaced by Major Aleksey A. Gubarev.⁹⁰

The project may have accelerated quickly, but it is clear that by 1968, Kozlov had lost much interest in the Soyuz-VI. His branch was intensively busy with the development of more important photo-reconnaissance satellites. Mishin, perhaps pragmatically, seems to have been more focused toward creating an improved version of the Soyuz, the 7K-S, than the actual OB-VI station itself. And without doubt, the target of all his energies was focused not on the Soyuz-VI station, but on the programs he had inherited from his late mentor Korolev—the Soyuz, the UR-500K-L1, and the NI-L3 projects. As the Moon seemed to loom close enough to reach, the year 1968 would have Mishin and his engineers set out on the penultimate lap of the race to the Moon by finishing up an extensive testing program for the N1-13 rocket complex, certainly the most intensive such effort to date in the history of the Soviet space program.

Preparing for the Landing

Through 1968, U.S. television and the press were full of rumor and hearsay on the impending introduction of a super-heavyweight Soviet launch vehicle comparable to the Saturn V. While some of this reporting was pure speculation, much of it was trickled down and leaked information from U.S. intelligence services, which were continuing to monitor activities at Tyura-Tam for clues to Soviet plans. During testimony in support of NASA's fiscal year 1969 authorizations to the House Committee on Science and Astronautics in February 1968, NASA

88 *Ibid* p 211

89 *Ibid*

90 The other cosmonauts in the Soyuz VI group established in early 1968 were V B Alekseyev M N Burdayev Yu N Clazkov L D Kizim A Ya Krarnarenko M I Lisun A Ya Petrushenko N S Porvatkin G V Sarafanov E N Stepanov and V D Zudov See Lantratov "Dmitriy Kozlov's Zvezda " Other sources suggest that three other cosmonauts—V A Grishchenko V I Gulyayev and D A Zaykin—were also training for Soyuz VI Note that Grishchenko and Gulyayev resigned from cosmonaut training on February 5 1968 and March 6 1968 respectively

Administrator James E. Webb told his distinguished audience: ". . . there are no signs that the Soviets are cutting back as we are. New test and launch facilities are steadily added . . . and a number of spaceflight systems more advanced than any heretofore used are nearing completion."⁹¹ Webb also forecast the introduction of a Soviet booster more powerful than the Saturn V. Five months later, George E. Mueller, the NASA Associate Administrator for Manned Space Flight, added fuel to the fire in a private memorandum distributed to Apollo contractor personnel in which he stated that the Soviets were developing a "large booster, larger by a factor of two, than our Saturn 5."⁹² In May 1968, one American journalist encapsulated the tone of these sporadic reports on the giant Soviet super-booster:

This booster, like the Loch Ness Monster or Soviet submarines seen off the East Coast when the American Navy's budget is under review, tends to be mentioned by witnesses who are considered unreliable or prejudiced. But students of Soviet space trends say there is direct evidence that the booster will appear when the Russians are ready to show it. This conviction is apparently based on evidence — reconnaissance photographs of rocket engine test stands or perhaps new launching pads.⁹³

As was customary, Soviet officials never once mentioned the N1 rocket, although through the first part of 1968, they continued to make repeated allusions to the possibility of Soviet cosmonauts flying and even landing on the Moon in the near future."

Behind the veil of secrecy, the N1 was indeed emerging in metal, but it was months behind the latest schedule. As stipulated by the February 1967 decree from the Central Committee and the Council of Ministers, the first test flight of the launch vehicle was set for the third quarter of the same year. Cosmonauts were to lift off in the N1-L3 complex in April 1968. Slowly, deadlines shifted month by month, until engineers lost another year engaged in a very broad ground testing program carried out at more than a dozen different locations.

Engineers built more than thirty-five full-scale experimental assemblies of the most intricate, heavily loaded elements of the rocket's frame, many of which were tested at the Central Scientific-Research Institute of Machine Building next door to TsKBEM in Kaliningrad. In addition, individual sections of the booster structure were verified for strength and stability at specially built test stands built in 1967 at the Experimental Machine Building Plant belonging to TsKBEM. The comprehensive ground testing included: work on precision and pressurization: testing in deep vacuum and in weightless conditions; work on the mechanical and pyrotechnical systems of separation and docking and on the pneumo-hydraulic systems of the rocket stages; work on the command instruments and measurement systems, power sources, armature, and life support systems of the L3 complex; testing in high temperatures and vacuum: static testing of the rocket stages (including work on the thermodynamic processes associated with fueling the stages, storage, and preparation for launch): and work on the booster at the launch position (including checking the thermodynamic processes of the propellant

91 NASA Science and Technology Division *Astronautics and Aeronautics* 1968 p 34

92 John Noble Wilford "NASA Aides Fear Soviet Space Gain" *New York Times* August 14 1968 p 11

93 Clark "Soviet Advances in Space Awaited" p 50

94 Perhaps the only hint by a Soviet official during 1968 on the existence of the N1 rocket was a statement by Academician L. I. Sedov on West German television on March 20 1968 "Special rockets are now available very large rockets which have been built exclusively for space research purposes. These rockets make it possible to consider practically many things of which formerly one could dream. Flights to the Moon and space flight to the planets are now quite feasible." See *Soviet Space Programs* 1966-70 p 369

systems of the ground complex, the system of docking the rocket to the launch complex, and the technological processes of preparing the launch complex and the rocket for launch)."

Among the many problems engineers encountered at the time was how to protect the bottom part of the rocket from the thermal and mechanical effects of the exhaust coming from the array of liquid-propellant engines. Specially developed materials were subsequently tested in various simulated conditions, although they would not be ready until the fifth launcher manufactured for launch, vehicle no. 7L.⁹⁶ Testing the booster's propellant tanks proved to be more difficult than anticipated. During some tests in 1967, the tanks were completely destroyed when internal pressure reached three atmospheres despite the fact that they were rated to handle over that limit during emergencies." Another problematic issue involved dynamic precision with regard to pulsation pressure in the rocket's tanks, which seemed to have thwarted work in the late spring of 1967. As late as July 1968, TskBEM Deputy Chief Designer Sergey O. Okhapkin, the man responsible for much of the work on the NI, reported that there was still much about the dynamic precision of the rocket's first three stages that was unresolved.

If earlier the development of the NI's engines threatened to be the major bottleneck in the program, by 1967-68, the Trud Design Bureau (formerly OKB-276) was finally able to report good progress. By September 1967, Trud, under the direction of its Chief Designer Kuznetsov, had completed the construction of two major engine static stands at Kuybyshev, the EU-28 and the EU-29, for ground tests of individual engines of the first and second stages of the NI in both nominal and adverse conditions. The testing at Trud was followed by a second series at the mammoth testing facilities of the famous Scientific-Research Institute for Chemical Machine Building (formerly NII-229), the premier rocket engine test facility in the Soviet Union, located at Zagorsk. Stands originally built for R-7-based boosters were redesigned to fire all of the NI's stages except, of course, the important first stage, which remained an unknown quantity and would have to be flown "green." The testing at Zagorsk began with "cold" firings of the NI stages, followed by:

- Firings on the EU-87 test stand of individual tests of the NK-15 first-stage engines
- Three firings on the EU-16 test stand of the Blok B (second) stage
- Four live firings on the EU-16 of the Blok V (third) stage
- Firings on the EU-15 test stand of the Blok G (fourth) stage
- Firings of the Blok D (fifth) stage⁹⁷

"Interdepartmental testing" of all the engines as separate units was carried out between September and December 1967, opening the way to the firing of complete prototypes of the second and third stages, which were completed by June and August 1968, respectively.⁹⁹

95 Semenov, ed. *Raketno-Kosmicheskaya Korporatsiya*, p. 255

96 R. Dolgopyatov, B. Dorofeyev, and S. Kryukov. "At the Readers' Request: The NI Project" (English title). *Aviatsiya i kosmonavtika* no. 9 (September 1992) 34-37

97 Kamanin. "A Goal Worth Working for." no. 46

98 Semenov, ed. *Raketno-Kosmicheskaya Korporatsiya*, p. 256-57; Boris Arkadyevich Dorofeyev. "History of the Development of the NI-L3 Moon Program," presented at the 10th International Symposium on the History of Astronautics and Aeronautics, Moscow State University, Moscow, Russia, June 20-27, 1995. The EU-16 firings were carried out on February 2, 1967, April 13, 1967, August 23, 1967, and November 25, 1970. The EU-15 firings were carried out on June 23, 1968, August 29, 1970, and December 15, 1973. EU-15 was the site of a major accident on June 15, 1968

99 Igor Afanasyev. "NI Absolutely Secret" (English title). *Krylya rodiny* no. 11 (November 1993): 4-5; Dolgopyatov, Dorofeyev, and Kryukov. "At the Readers' Request: The NI Project", Vad. Pikul. "The History of Technology: How We Conceded the Moon: A Look by One of the Participants of the NI Drama at the Reasons Behind It" (English title). *Izobretatel i ratsionalizator* no. 8 (August 1990) 20-21

Progress on the L3 lunar complex was much slower than that of the NI, partly because of continuing modifications to the design through 1968 as a result of ground testing and monetary restrictions. Engineers carried out three major ground firings of Blok D in 1967 in support of L3 operations: these were in addition to the two Earth-orbital launches of the acceleration stage as part of the circumlunar LI project. One of the major concerns regarding Blok D was its operation for powered descent initiation from lunar orbit. During discussions in January–February 1968, the engineers and Chief Designers expressed reservations that after finishing its part of the deorbit firing, the subsequent ejection of Blok D from the Lunar Ship (LK) lander could be dangerous because of a Blok D explosion upon impact on the lunar surface. Among the options explored were the possibility of increasing the propellant of the lander engine to raise the altitude of separation, or even re-igniting Blok D to move the stage further away from the lander. To be perfectly sure of Blok D operation during the entire landing phase, Mishin and his deputies tabled plans at the time to carry out a series of "rehearsal" tests in Earth orbit using the Proton booster. For this, the engineers proposed creating the LIE vehicle, which would consist of a simplified automated 7K-LI circumlunar vehicle, an experimental Blok D upper stage, and a special payload fairing for the complex. During its mission, the LIE would specifically test two major operations: lunar-orbit insertion and powered descent from lunar orbit, both crucial maneuvers on the landing flight."¹⁰⁰

During 1968, the engineers were still debating over the docking radar for the LK, choosing from two competitive variants. Igla and Kontakt. Despite the better performance characteristics of the former, for inexplicable reasons, the engineers chose the latter, designed by the Scientific-Research Institute of Precision Instruments under Chief Designer Mnatsakanyan, for the LK. It seems that the lander's *Planeta* radar was, however, based on Igla. Perhaps the most critical element of the LK, the Blok Ye main engine, was suffering severe delays in its development program at the time. Full-scale ground tests of the lander engine had been scheduled for 1966, then 1967, but the timelines were continually moved back. At a meeting in March 1968, Ivan I. Ivanov, the leading designer for the engine at the KB Yuzhnoye (formerly OKB-586), reported that the engine was displaying a specific impulse three seconds lower than needed during test runs—a serious problem that would affect the mass of the LK, which had already been reduced down to an absolute minimum.¹⁰¹

In the United States, NASA had plans to test the Apollo Command and Service Module and the Lunar Module in Earth orbit before declaring them safe for lunar operations. Not surprisingly, the Soviet Union had similar plans for their two analogous spacecraft, the Lunar Orbital Ship (LOK) and the LK. In 1967, Mishin had approved plans to design and build Earth-orbital versions of both vehicles, called the T1K and T2K, respectively. The two spacecraft would be equipped with fully functional life support systems to carry a single crewmember each. As was customary for the Soviets, the piloted flights would be preceded by joint automated flights of the T1K-T2K, also in Earth orbit. The T1K would be launched into orbit by the powerful UR-500K Proton booster, while the T2K would use a modified version of the Soyuz launch vehicle designated the 11A511L. Once in orbit, the T2K would simulate a descent to and an ascent from the lunar surface, followed by docking with the T1K. The two vehicles would then separate, with the descent apparatus of the T1K returning to Earth for recovery."¹⁰² Despite the uncertainty regarding the Blok Ye engine, TsKBEM engineers were optimistic in their

¹⁰⁰ Semenov ed. *Raketno-Kosmicheskaya Korporatsiya* p. 228

¹⁰¹ In December 1966 the first test of Blok I (LOK) was set for July 1967 and the first test of Blok Ye (LK) was set for August 1967

¹⁰² K. Lantratov "The Fall From Orbit of the Last Soviet Lunar Ship" (English title) *Novosti kosmonavтики* 25 (December 3–16, 1995) 32–36

schedules for the T1K and T2K missions in Earth orbit. In March 1968, Mishin was planning for the first TZK launch in October 1968, with the second and third models a month later. In August, Mishin discussed with Chief Designer Gay I. Severin of the Zvezda Design Bureau, the man responsible for all spacesuits in the Soviet space program, the possibility of using *Yastreb* EVA suits on the T1K and T2K for a possible spacewalk. The idea seems to have been dropped soon after because of the added complexity of such a mission.

Much of the testing on the LK and LOK was carried out at the TsKBEM plant or at the imaginatively titled Scientific-Research Institute for Chemical and Construction Machines at Sergeyev Posad. These tests included those for the separation of the LOK and the LK in nominal and emergency situations, the docking systems, and the separation of Blok D. The same institute was also the location of landing tests of the lunar lander mock-ups to refine the design of the LK. At least 200 drop tests of the descent framework were conducted, half of them with full-sized prototypes. Engineers devised different simulated lunar landscapes for a variety of situations and introduced various landing profiles. For example, three different parameters, including the horizontal velocity (zero to one and a half meters per second), the height of the fall (several meters), and the angle of contact with the surface (thirty degrees to negative values), were considered. Designers also experimented with craters of various dimensions, repeating tests over and over to eliminate random results. Engineers carried out pyrotechnical separation tests to verify the operation of liftoff from the Moon, a problem made more difficult by temperature deformations in the ascent stage and none in the descent portion.¹⁰³

Of the many potential hazards facing the LK during operations near the Moon, one of the most imposing was the influence of lunar gravitational anomalies. During the early robotic lunar probe missions in the mid-1960s, lunar satellites such as Luna 10, Luna 11, and Luna 12 deviated significantly from their expected trajectories around the Moon, raising the specter of such errors during piloted operations. To map out magnetic and mass anomalies on the lunar surface that could affect orbital vectors, engineers at the Lavochkin State Union Machine Building Plant under Chief Designer Babakin designed small lunar satellites designated the Ye-6LS to assist in mapping gravitational anomalies on the Moon. The first such spacecraft was launched on May 17, 1967, by a four-stage 8K78M booster (better known as the Molniya-M). Unfortunately, its Blok L translunar injection malfunctioned and was not able to impart sufficient velocity to the probe. As a failed deep space probe, the Soviet press referred to it by the nondescript name of *Kosmos-159*.¹⁰⁴ A second Ye-6LS probe failed to reach orbit on February 7, 1968, when the third-stage engine cut off prematurely at T+524.6 seconds because it ran out of propellant. Babakin was third time lucky, when vehicle no. 113 was launched successfully on April 7, 1968, and arrived at the Moon a few days later, officially named *Luna 14* in the Soviet press. Communications with the probe was carried out by the large TNA-400 dish at Simferopol in Crimea. Apart from successfully mapping gravitational anomalies, Luna 14 also carried motor

¹⁰³ V. Filin "At the Request of the Reader: The N1 L3 Project" (English title) *Aviatsiya i kosmonavtika* no. 2 (February 1992) 40-41. Semenov ed. *Raketno Kosmicheskaya Korporatsiya* p. 256. Note that the descent stage was not temperature controlled.

¹⁰⁴ "Calendar of Memorable Dates" (English title) *Novosti kosmonavtiki* 10 (May 5-18, 1997) 51-53. Timothy Varfolomeyev "Soviet Rocketry that Conquered Space: Part 6: The Improved Four Stage Launch Vehicle 1964-1972" *Spaceflight* 40 (May 1998) 181-84. Although *Kosmos 159* did not reach lunar orbit, it did attain a highly elliptical orbit with an apogee of 60,637 kilometers, the highest for any satellite in the *Kosmos* series. Western analysis of the *Kosmos 159* launch suggests that based on its launch time, it was launched directly away from the Moon, much like *Zond 4*. See Phillip S. Clark "Obscure Unmanned Soviet Satellite Missions" *The Journal of the British Interplanetary Society* 46 (October 1993) 371-80. More recent evidence suggests that *Kosmos 159* did indeed enter its originally planned orbit. See Timothy Varfolomeyev "Soviet Rocketry that Conquered Space: Part 5: The First Planetary Probe Attempts: 1960-1964" *Spaceflight* 40 (March 1998) 85-88.

drives for testing different materials, lubrications, and coating for the wheels of the future Ye-8 lunar rover.¹⁰⁵

The rover, for transporting cosmonauts from one lander to another on the Moon's surface, was Babakin's most important contribution to the Soviet lunar flotilla of the 1960s. In early 1967, Soviet space officials tabled a new proposal to build upon the Ye-8 rover: why not build a compact spacecraft capable of landing on the Moon, recovering a tiny portion of lunar soil, and then returning to Earth?¹⁰⁶ The idea was clearly motivated to a great extent as insurance against losing the race to the Moon. If all else failed—and Apollo was about to land on the Moon—then Babakin could dispatch one of these robots to recover soil before any American astronaut. It was a pragmatic public relations exercise, but one that obviously had important scientific payback. The proposal apparently originated from Babakin's design bureau, and it was the subject of "a brief but heated debate" before being approved for implementation.¹⁰⁷

As with the L3 program, the primary limitation for the soil return spacecraft was mass. Instead of developing a completely new vehicle, Babakin chose to model his sample returner on the Ye-8 rover by using its descent platform, the so-called KT stage. But instead of the lunar rover as a payload, the KT would carry a vehicle capable of scooping some soil, lifting off from the Moon, heading for Earth, and reentering into Earth's atmosphere for subsequent recovery. Babakin designated the spacecraft Ye-8-5 to distinguish it from its antecedent, the Ye-8 rover.

When beginning to design the Ye-8-5 vehicle, the engineers assumed that it would be necessary to correct the return trajectory of the capsule on its trip back to Earth—that is, it would require complicated optical and gyroscopic devices, command radio links, and a rocket engine, all exceeding the mass requirements for the spacecraft. A solution to the problem came from Dmitriy Ye. Okhotsimskiy, one of the star scientists at the Institute of Applied Mathematics of the Academy of Sciences: he had helped optimize the design of the first Soviet ICBM in the early 1950s and later worked on many early Soviet space projects. Okhotsimskiy's mathematical analysis showed that among the possible trajectories on the return flight from the Moon, there were a small class of passive flight trajectories that do not require correction and exist only on the "Moon-to-Earth" trip because of the strong influence of Earth's gravity. He found that with these passive trajectories, the landing point on Earth depends on the starting point on the Moon. This meant that the landing point had to be very exact, to within plus or minus ten kilometers of a specified point on the lunar surface. The study of lunar gravitation anomalies on Luna 10, Luna 11, Luna 12, and Luna 14 proved to be extremely useful for mathematical analyses of landing profiles from lunar orbit."¹⁰⁸

Babakin's engineers fought long and hard with the mass constraints. The launch vehicle for the Ye-8-5 was the same as that for the Ye-8, a four-stage Proton booster that could put a mass

105. N. G. Babakin, A. N. Banketov, and V. N. Smorkalov, *G. N. Babakin zhizn i deyatelnost* (Moscow: Adamant, 1996), pp. 54–55; Lardier, *L'Astronautique Soviétique*, pp. 182, 267. The TNA-400 was designed by OKB MEI under Chief Designer A. F. Bogomolov. Luna 14 also carried scientific instruments, including one for measuring charged particles from the Sun. See Kenneth Catland, *Robot Explorers* (London: MacMillan, 1972), p. 140.

106. Note that K. Lantratov, "The 'Late' Lunar Soil" (English title), *Nouosli kosmonavtrkr* 15 (July 16–29, 1994): 41–43, states that the sample return effort began in 1968, not 1967.

107. Yu. A. Mozzhorin, et al., eds., *Dorogi v kosmos. I* (Moscow: MAI, 1992), p. 163.

108. B. V. Rauschenbach, "Soviet Program of the Moon Surface Research," presented at the 45th Congress of the International Astronautical Federation, IAA-94-IAA 2.2.626, Jerusalem, Israel, October 9–14, 1994. There were additional limitations on the Ye-8-5 lunar probe. With a passive trajectory, the predicted landing point on Earth was too wide for effective search. This required transmission of the actual post-takeoff trajectory from the Moon, which meant that the return ship needed to carry complex radio-technical equipment. Okhotsimskiy bypassed this problem by proposing the use of radio equipment working in the meter range instead of the standard decimeter range, thus reducing the mass of the communications instrumentation. These transmissions would also be augmented by ground observations to measure angular velocity of the returning ship from a distance of 150,000 kilometers from Earth.

of only 5.550 kilograms on a translunar trajectory from Earth orbit. This would include both the KT descent stage and the actual scooper with its returning spacecraft. Despite a widespread and intensive effort to reduce the mass of the Ye-8-5 sample returner. Babakin was able to produce a vehicle with a mass of only 5.880 kilograms. With the project in jeopardy, Babakin convinced both Chelomey and Mishin to optimize the capabilities of the Proton and the Blok D stage, respectively, to allow the rocket to carry the increased mass. Chelomey and Mishin evidently were able to fulfill Babakin's requirements by reworking several systems and reducing reserve propellant.¹⁰⁹

The Earth-to-Moon trip for the Ye-8-5 sample returner was identical to that of the Ye-8 rover. A nominal flight for the Ye-8-5 would begin with its launch into a low-Earth orbit by the Proton. About seventy minutes after launch, Blok D would fire a second time to insert the payload on a trajectory toward the Moon. After two mid-course corrections, the Ye-8-5 would fly into a 120-kilometer-high lunar orbit four days and seven hours after launch. In lunar orbit, the ship would conduct two further corrections: the first to reduce perilune down to twenty kilometers over the landing point and the second to straighten out the plane of approach. After seven days and sixteen hours in space, the Ye-8-5 would fire its I1D417 engine to initiate powered descent from lunar orbit, landing on the lunar surface on its KT descent stage within six minutes.

The KT stage for the sample collector was identical to the one on the lunar rover except for the addition of a 0.9-meter-long remote arm with a drill appendage, stored in an upright position. After landing on the Moon, the arm would be rotated down to the target area. Electric motors, tested on Luna 14, would allow the arm to sweep over a 100-degree arc, while the drill itself could be swiveled in elevation. The latter consisted of a hollow rotary/percussion bit to drive into the surface. The Ye-8-5 ascent stage consisted of three spherical tanks for nitric acid and unsymmetrical dimethyl hydrazine for the ascent stage engines, which was composed of the S5.61 with a thrust of 1.92 tons placed in the center and four outbound verniers attached to the tanks. A pressurized cylinder above the central tank contained control, communications, and power equipment including gyroscopes and accelerometers. Four antennae were placed orthogonally on the horizontal plane on the outside of the cylinder. The central component of the ascent stage was a small thirty-nine-kilogram spherical capsule with a diameter of fifty centimeters placed at the top of the cylinder. Internally, in the upper portion, the capsule carried parachutes and descent antennas. The middle part had a receptacle for the sample, and the lower part had batteries and transmitting equipment that produced a displaced center of gravity toward the bottom where the ablative heat shield was the thickest. Once the remote arm had collected the soil, the arm would raise the drill and insert the soil into the small capsule at the top of the craft, pressurize it, and then seal it. The capsule as a whole was attached to the rest of the ascent stage via straps.¹¹⁰

After one day and two hours on the lunar surface, the ascent stage would lift off from the Moon and enter a direct trajectory toward Earth. There would be no mid-course corrections on the return trip, and its ultimate destination would depend on the precision of the trans-Earth injection burn. After a flight lasting eleven days and six hours, the small capsule would land on Soviet territory.

Preparations for both the Ye-8 and the Ye-8-5 accelerated through 1968. During the middle of the year, the lunar rover was subjected to ground simulations at a specially constructed lunar landscape near Simferopol in Crimea. At least five firing tests of the KT lander stage took place in late 1968 at Zagorsk, one of which was less than successful because of a premature engine cutoff.¹¹¹

109. Babakin, Banketov, and Smorkalov, *G N Babakin*, p. 54

110. Andrew Wilson, *Solar System Log* (London: Jane's Publishing Co., 1987), pp. 61-62

111. O. A. Sokolov, "The Race to the Moon: A Look from Baikonur," presented at the 45th International Astronautical Congress, IAA-94-2.1.610.

Babakin's Ye-8-5 sample scooper may not have been an integral part of the NI-L3 lunar landing program, but it added to the burden of the Soviet lunar effort of the period. The repeated additions and modifications to the NI-L3 plan in 1965–67 also complicated mission design. Even after the ink was dry on a final draft plan for a particular element of the L3 complex, months later, engineers would propose modifications based on new anticipated needs. This not only made it impossible to manufacture flight models of the spacecraft, but also added layer after layer of complexity to the NI-L3 mission. By 1968, the following components were part of the entire program:

- Ye-6LS (two robot probes to map lunar gravitational anomalies)
- Ye-8LS (two robot lunar satellites to photograph the lunar surface)
- TIK-T2K (automated and piloted flights of the LOK and LK in Earth orbit)
- LI E (automated test of the Blok D stage in Earth orbit);
- NI-LI (two lunar orbital LI flights as test payloads for early NI launches)
- Ye-8 (two lunar rovers to serve as transport for cosmonauts);
- NI-L3 (one NI launch with the backup LK)
- NI-L3 (one NI launch with two cosmonauts to land on the Moon)

This was in addition to the huge effort expended on the separate LI circumlunar project. For a launch profile that was to originally include a single launch to the Moon, the Soviet program to land cosmonauts on the Moon now included a multitude of weak links that could seriously disrupt the schedule. Perhaps one of the few confidence boosters for Soviet space engineers at the time was the majestic sight at Tyura-Tam of the first NI rocket as it was wheeled out to its launch pad.

The NI Arrives . . . and Leaves

During late 1967, the Soviets could not have ignored the hoopla surrounding a significant milestone in the U.S. space program. On November 9, 1967, the first Saturn V booster lifted off from Launch Complex 39 at the John F. Kennedy Space Center at Cape Kennedy, Florida. *Apollo 4*, as it was called, was a magnificently successful mission, vindicating the so-called "all-up" philosophy, coming on the heels of what one observer called "the most exhaustive ground-test program in aerospace history."¹¹² Coincidentally or not, the Soviet government issued a new decree five days after the Apollo 4 launch—one that amended the unrealistic targets laid down in the important February 1967 resolution on landing Soviet cosmonauts on the Moon. The new decision, adopted on November 14, called for the initiation of flight testing of the NI booster in the third quarter of 1968, almost a year behind the Saturn V. A date for a landing was apparently not specified: the authors of the decree merely stated that it would take place "in a period ensuring the preeminence of the Soviet Union in the exploration of space"—that is, before the Americans."¹¹³ Mishin recalled decades later that "by then, it was already clear that the dates set by these directives were unrealistic. They were not backed up by funds, or production capacities, or resources."¹¹⁴ According to the chief designer, spending on

112. Roger E. Bilstein, *Stages to Saturn. A Technological History of the Apollo/Saturn Launch Vehicles* (Washington, DC: NASA SP-4206, 1996), pp. 347–48.

113. Mikhail Rudenko, "Space Bulletin: Lunar Attraction: Historical Chronicles First Publication" (English title), *Vozdushnyi transport* 28 (1993): 10; V. P. Mishin, "Why Didn't We Fly to the Moon?" (English title), *Znaniye: tekhnika. seriya kosmonavtika. astronomiya* no. 12 (December, 1990): 3–43.

114. Mishin, "Why Didn't We Fly to the Moon?"

the N1-L3 at its peak in 1967-68 amounted to about \$1.5 billion. compared to Apollo's nearly \$3 billion at its peak in 1966-67.¹¹⁵

When the Saturn V blasted off from Cape Kennedy, half a world away in the Kazakhstan desert at Tyura-Tam. Soviet engineers were putting the finishing touches on the first N1 mock-up. The supervisory body over the entire N1-L3 program, the so-called Council for the Problems of Mastering the Moon, met on October 9, 1967, to discuss these preparations as well as the overall status of the Soviet lunar landing program. Mishin reported that the first N1 flight model would only be able to lift seventy-six tons, while a slight modification of the second stage would allow the attainment of the nominal ninety-five tons required for a lunar landing for a single cosmonaut. More improvements in the first and second stages, including raising the thrust of the NK-15 engines from 154 to 170 tons, would provide a payload capability of 105 tons, sufficient to carry two instead of one cosmonaut down to the surface. Such a plan had been discussed among the senior staff in mid-1967, apparently prompted by continuing grave concerns over the safety of having a single cosmonaut on the surface of the Moon. Academy of Sciences President Keldysh was one of the strongest supporters of the two-cosmonaut plan, making the somewhat implausible proposal at the October 1967 meeting that the council should seriously consider landing two cosmonauts on the Moon on the very first launch of the N1. If that was impossible, then the mission should try and land a lone cosmonaut." Keldysh's voice was not the only one touting this absurd idea. Communist Party General Secretary Brezhnev was rumored to have said: "We should prepare for a manned mission to the Moon straight after the first successful launch of the N1, without waiting for it to be finally developed." Mishin understandably reasoned that it would be absolutely impossible to land two cosmonauts on the Moon on the first or second N1.

Brezhnev's ludicrous demands underline to a great degree the incredible gap between the people building the spacecraft and those who controlled the purse strings. If there were expectations that the creation of the Ministry of General Machine Building in 1965 would put an end to the institutional chaos in the space program, they were never fulfilled. The managerial chaos was underlined at an important meeting after the Apollo 4 mission. On January 23, 1968. Minister Afanasyev hosted a large conference with the senior staff at TSKBEM, including Mishin, Bushuyev, Chertok, Okhapkin, and Tregub, at which the primary subject of discussion was the N1-L3. Afanasyev pulled no punches and bluntly blamed Mishin for all the troubles in the Soviet space program. Going down the litany of delays and failures in the program, Afanasyev spared no words in criticizing the performance of TSKBEM and Mishin in particular. While the poor results of the N1 program could not be attributable to the incompetence of one man. Afanasyev had good reason to single out Mishin. In the two years since he had assumed the post of chief designer of the design bureau, there had been nothing but failure. Mishin was also stubborn and ill-tempered, and he constantly alienated those around him, from his deputies to the other chief designers. Of the original five chief designers who were alive, only Pilyugin and Ryazanskiy had "normal" relationships with Mishin. The three others had some form of complaints against what they considered his rude behavior and poor leadership qualities.

¹¹⁵ The figure of \$1.5 billion is extrapolated from 'The Moon Programme That Faltered' *Spaceflight* 33 (January 1991) 2-3 in which Mishin gives a figure of 'half a billion' rubles. The conversion rate used was \$3 = 1 ruble which was the *unofficial* rate at the time. The figure for Apollo is taken from Janevan Nimmen and Leonard C. Bruno with Robert L. Rosholt *NASA Historical Data Book Volume I NASA Resources 1958-1968* (Washington DC NASA SP 4012 1988) p. 148. The precise figures for 1966 and 1967 were \$2.9713 billion and \$2.8779 billion respectively.

¹¹⁶ Kamanin, "A Goal Worth Working for" no. 47

¹¹⁷ *What Stars Are We Flying to?* (English title) Moscow Teleradiokompaniya Ostankino Television First Program Network Moscow April 9 1992 0825 CMT

Despite the rising complaints against Mishin, he was not dismissed. Some believed that Ustinov kept him on as the "fall guy" to take the blame for a program that was all but doomed to fail. The chief designer may have also had powerful supporters in key positions, one of them being Politburo member Andrey P. Kirilenko.

At the meeting in January 1968, Mishin clearly articulated some of the inherent managerial problems at TsKBEM. In some ways, his two basic points were more substantive than Afanasyev's introductory tirade. The chief designer strongly believed that his design bureau was overburdened with extraneous tasks, which prevented it from concentrating on such space projects as the NI-L3. Primary among these was the solid-propellant RT-2 ICBM project, which swallowed a lion's share of the design bureau's resources in the late 1960s. Mishin also complained about having to work on subsystems, such as launch escape towers and spacecraft landing systems, simply because subcontractors were unable to do so. His second point was aimed at the organization of the Soviet space program, and in particular Afanasyev's Ministry of General Machine Building. He bluntly accused the ministry of not controlling the completion of items that were subcontracted out by TsKBEM—that is, not helping in having subcontractors meet deadlines, a job that was increasingly falling on already taxed engineers at the design bureau.

Mishin's deputies also spoke. Chertok and Bushuyev both admitted that it was TsKBEM's own fault that they were so overloaded with projects. They mentioned the 7K-L1 circumlunar program in particular, inherited from the Korolev days, as one that was a needless burden. The hasty and often personality-driven decisions of 1964–65 were finally having the negative consequences many had feared. In the end, as with many other meetings, nothing changed. Afanasyev refused to disrupt military programs, such as the RT-2 ICBM effort, in favor of "civilian" projects, such as the NI-L3. The missile project stayed at TsKBEM. Relations between the design bureau and its subcontractors remained just as chaotic. The engineers at TsKBEM shrugged their shoulders and went back to work."

Through the tumultuous events of the lunar program in the late 1960s, there was one curious politically motivated episode that threatened to derail the NI-L3 program as late as 1967. On November 17, 1967, the Central Committee and the USSR Council of Ministers issued decree no. 1070-363, which assigned General Designer Vladimir N. Chelomey to design and develop the UR-700 heavy-lift booster and the LK-700 lunar spacecraft to land two Soviet cosmonauts on the surface of the Moon by 1972 or 1973.¹¹⁹ To any observer with even cursory familiarity with the history of the Soviet piloted lunar program, this decision remains one of the most inexplicable—one that even the most intricate machinations of political intrigue fail to explain. How could the Soviet government commit to a second lunar landing program at a time when millions had been expended on the NI-L3? How did the UR-700 program reemerge after an official interdepartmental commission had already passed it over in favor of the NI-L3? According to Sergey N. Khrushchev, the former Soviet leader's son, the action was partly motivated by the astonishing delays in the NI-L3 program. He hints that the idea belonged to Minister of General Machine Building Afanasyev, who was increasingly at odds with his boss Ustinov over support to Chelomey's organization.¹²⁰ Cool in his promotion of the late Korolev's dreams, Afanasyev began to shift his allegiance to Chelomey's programs with the formidable backing of new USSR Minister of Defense Andrey A. Crechko. The UR-700 may have had other supporters,

¹¹⁸ There is a detailed account of this meeting in Chertok. *Rakety i lyudi goryachiye dni kholodnoy uoyny* pp. 479–87.

¹¹⁹ A second decree (no. 472) was issued by the Ministry of General Machine Building on November 28, 1967.

¹²⁰ Sergey Khrushchev *Nikita Khrushchev krizisy i rakety. vzglyad iznutri*. tom 2 (Moscow: Novosti, 1994), p. 524.

specifically Chief Designer Glushko and Air Force Col. General Kamanin, both of whom were vocal and vociferous opponents of Mishin.¹²¹

The new order tasked Chelomey to produce a draft plan for the UR-700 and the LK-700 within a one-year period. According to Khrushchev, Chelomey was very reluctant to take on the order, and he did not believe that any program at this late stage could be competitive with Apollo. Perhaps expecting another accident to delay Apollo, Chelomey sank his teeth into reviving the UR-700 proposal, tasking the development of the booster to his Branch No. 1 at Fili under his First Deputy Viktor N. Bugayskiy. Having already worked on the project for several years, Chelomey and Bugayskiy were able to produce the draft plan for the LK-700 lunar landing ship as early as September 30, 1968. Engineers finished the draft plan for the gigantic UR-700 rocket on November 15, just two days before the stipulated deadline." They may have worked on time to produce the results desired by Afanasyev, but the second coming of the UR-700 slowly sank into oblivion. The Americans were racing ahead with Apollo, there was already a huge commitment to the NI-L3, and Chelomey himself had little interest in forcing through this last-minute gasp. Perhaps understandably, Mishin's faction was less than pleased with the entire debacle. According to one of Bugayskiy's deputies:

[W]e received the order for the 200 ton rocket and began working. And suddenly the specialists from Korolev's Design Bureau were writing a memo to the Minister of General Machine Building S. A. Afanasyev. Soon they "killed" our 200 ton rocket, and Korolev's people were left without any competitors.¹²³

Chelomey's engineers never built their gargantuan booster: "All the work on the UR-700 was limited to the design and the mock-ups of certain sections of the rocket."¹²⁴ Like so many of Chelomey's dreams, the UR-700 never left Earth. By early 1969, Chelomey had abandoned work on his alternative lunar landing project.

As for the NI, components for the first batch of rockets were produced initially in February 1967 at the Progress Plant at Kuybyshev. After production, the parts were then transported to Tyura-Tam, where they were assembled at the giant assembly-testing building. The first group included two mock-ups for ground testing and fourteen models for flight testing. Later operational batches would be manufactured based on the results of the first set of launches. The first NI mock-up, vehicle no. IM1, was designed and built to allow engineers to refine the dynamic characteristics of all the ground assemblies and the rocket itself and was not meant for flight. They used the mock-up, a complete engineering model with a nose section, to carry out integrated final ground testing of the NI-L3 complex as well as to perform procedures for prelaunch preparations. The results of these tests would clear the way for releasing the first flight article, NI vehicle no. 3L, for launch. Just two weeks after the Saturn V launch, on November 25, 1967, the IM1 was moved on rail tracks from the assembly-testing building to the first completed launch pad at site 110P.¹²⁵ At the pad, giant cranes raised the booster to a vertical

¹²¹ In a diary entry on August 31, 1974, Kamanin recalls that he and Glushko, in 1967, proposed the cancellation of the NI-L3 program, presumably in favor of the UR-700 project. See N. Kamanin, "I Feel Sorry for Our Guys" (English title), *Vozdushniy transport* 15 (1993): 12.

¹²² Khrushchev, *Nikita Khrushchev*, tom 2, p. 524.

¹²³ Dmitriy Khrapovitskiy, "Absolutely Unclassified: The Ground Waves of Space Politics" (English title), *Soyuz* 15 (April 1990): 15.

¹²⁴ Ibid.

¹²⁵ V. A. Lebedev, "The NI-L3 Programme," *Spaceflight* 34 (September 1992): 288-90; Afanasyev, "NI Absolutely Secret." Note that there were originally three mock-ups of the NI: IM1, IM2, and IM3. The IM3 eventually became the first flight article, 3L.

position. It seems that the magnificent view of the graceful rocket lifted spirits considerably. U.S. spy satellites were also watching. In a classified report at the time, the CIA reported:

[O]n several occasions since December 1967. (the NI) has been erected on the pad while on other occasions the pad has been empty, suggesting the Soviets are testing the erection and checkout facilities of the system. The vehicle has not been flown but there is no evidence that the program is experiencing major difficulties."

On December 1, the Moon council met once again under Afanasyev's tutelage. Almost all the luminaries of the Soviet space program, including Minister of Aviation Industries Petr V. Dementyev. Commander-in-Chief of Strategic Missile Forces Marshal Nikolay I. Krylov. Tyulin. Kerimov, Mishin, Barmin. Kamanin, and many other chief designers, were present. The reports were fairly positive. Save for a few items on the service tower and some systems adjustments, the first launch pad was prepared for an actual launch. The IMI mock-up had been placed on the pad, while all its operational parameters were measured during three complete cycles, after which the booster was transported back to the assembly-testing building. The plan was to take the rocket out again to the pad to fuel it completely three times. Ground workers would then train for thirty days to master all operations in preparation for the first flight model of the NI. The flight article, rocket no. 3L, would then be moved to the pad and prepared for launch in the first half of March 1968, although all finishing work on the launch pad would not be completed until March 30. There apparently had been problems with the mock-up, for it was returned to the assembly-testing building on December 12, 1967, and moved back out once again in January. The official history of TsKBEM notes that the work highlighted the requirement for better technical documentation."

As workers labored to prepare the first NI flight model, focus shifted to the L3 complex. On January 15, 1968, the Moon council met to specifically discuss piloted lunar operations, both in lunar orbit and on the lunar surface. Apart from Mishin, Chief Designer Severin responsible for spacesuits and Deputy Minister of Health Avetik I. Burnazyan reported on the health safety measures for lunar surface operations. The news was not good. Severin, for example, told his audience that he would need two more years to clear his Krechet-94 suit for operations on lunar landing missions. One of Mishin's demands for the suit was that it be sufficiently robust for up to five kilometers of movement on the lunar surface and allow EVA operations for up to seventy-two hours, perhaps to enable the cosmonaut to survive decompression in the lander. Like most other chief designers, Severin's primary problem seems to have been the severe mass limits on the suit. At the time, the suit had a mass of approximately ninety kilograms. A large conference on the Krechet-94 and Orlan suits for the lunar mission was held on March 19, 1968, at Severin's Zvezda plant at Tomilino. Severin apparently had confidence in meeting Mishin's requests, reporting that the Krechet-94 would ensure EVA life support for six hours of work on the lunar surface, while the Orlan would provide two and a half hours, sufficient for the spacewalks in Earth or lunar orbit from one ship to another. Because the replenishment of oxygen and water would be possible from the LK or from the Ye-8 lunar rover on the surface of the Moon, the total operational time for the Krechet-94 would be as high as fifty-two hours.¹²⁸

126. U S. Central Intelligence Agency. "National Intelligence Estimate 11-1-69. The Soviet Space Program." Washington, DC, June 19, 1969. p. 14. as declassified in 1997 by the CIA Historical Review Program

127. Semenov, ed. . Raketno-Kosmicheskaya Korporatsiya. p. 573: Kamanin, "A Coal Worth Working for." no. 47: Kamanin. "A Coal Worth Working for." no. 49: Afanasyev. "NI: Absolutely Secret": Afanasyev, "Unknown Spacecraft "

128. Kamanin. "A Coal Worth Working for." no. 48: Kamanin. "A Coal Worth Working for." no. 49.

Presumably because of the results of the IMI tests. Mishin was unable to meet the March 1968 deadline for launch, informally delaying the attempt to May. Military units evidently did not completely master all operations related to the work of the huge emergency rescue system on top of the NI. To add to the problems, work was disrupted on the booster in April by the death of two men during ground tests.¹²⁹ Oxygen systems on the support tower were also incomplete for a launch. At a meeting on April 22, Mishin targeted May 5 for another full-scale testing of the flightworthy NI-L1 on the pad. The first launch article finally arrived at its pad on May 7, 1968. The launch was set for late May, despite concerns over the state of the booster engines, which were in less than perfect condition and only barely within the specified limits for testing.

The original payload for booster no. 3L had apparently been a 7K-LIE spacecraft equipped to test firings of the Blok D stage. At some point in 1968, the spacecraft was replaced by a dedicated circumlunar spacecraft re-equipped for flight in lunar orbit. In an example of the cross-pollination among the various lunar programs, this variant, known as the 7K-LIS, seems to have been left over from the short-lived plan to have the 7K-L1 dock in Earth orbit with a Soyuz spacecraft prior to its circumlunar mission. The spacecraft was equipped with the Engine Orientation Complex (known as the "DOK") from the L3's Lunar Orbital Ship. The complex, having a mass of around 800 kilograms, was installed at the forward end of the 7K-LIS on its prominent support cone to carry out attitude control. Because there was no need for docking on the NI's launch, the engine complex did not have the active node of the Kontakt docking system. The DOK was manufactured by a new entrant to the Soviet space program, the Arsenal Machine Building Plant based in Leningrad, whose design bureau was headed by Chief Designer Petr A. Tyurin.¹³⁰ The first complete 7K-LIS vehicle was assembled in March 1968, in time for the planned NI launch in two months.

The launch was not to be. At some point during the prelaunch testing, technicians discovered cracks in the first stage. Blok A, which had evidently formed when the rocket was mated to its payload.¹³¹ In such a condition, there was only one option: bring the booster back to the assembly-testing building and repair the cracks. The restoration took much longer than expected, introducing what would prove to be a fatal delay in the NI-L3 problem. Days turned to weeks, which eventually turned to months. It was not just the cracks on the NI, but also cumulative delays in the delivery of reliable equipment for ground operations, which was a significant factor in pushing back the deadline. In August, Mishin met with Ustinov and reported that subcontractors were continuing to break deadlines, that many electrical systems at the launch site did not meet specifications, and that there were many failures during ground testing. There was also a severe shortage of military personnel at Tyura-Tam for NI operations. Afanasyev and Mishin were looking at a best chance for launch in late 1968, yet *another* year behind schedule. The hopes of the Soviet Union in reaching the Moon before the Americans hopelessly sank into an intractable quagmire. By this time, NASA had already flown a second Saturn V booster and launched the first automated Lunar Module into Earth orbit.

¹²⁹ Military workers for the NI were part of the Sixth Scientific Testing and Experimental Directorate at Tyura Tam. See Jacques Villain, ed. *Barkonour la porte des étoiles* (Paris: Armand Colin, 1994), p. 73.

¹³⁰ That the original payload for booster no. 3L was a 7K-LIE is noted in Semenov, ed. *Raketno Kosmicheskaya Korporatsiya*, p. 573. The manufacture of the DOK DKP for the 7K-LIS was probably the first venture for the Arsenal Machine Building Plant in the Soviet space program. Later, in 1969-70, the organization took on 'design escorting' for the US naval reconnaissance satellite system originally developed by TsKBM under General Designer V. N. Chelomey. See M. Tarasenko, 'The Scientific Program of the KB Arsenal' (English title) *Novosti kosmonavtiki* 6 (March 11-24, 1996), 47-48; Dmitriy Litovkin, 'Space Projects of Arsenal' (English title) *Krasnaya zvezda*, January 13, 1996.

¹³¹ Afanasyev, 'NI Absolutely Secret'

Unlike the N1, the Saturn V used a high-performance cryogenic upper stage fueled by liquid hydrogen and liquid oxygen. Throughout 1968, as the race slowly slipped through their hands, many Soviet designers clearly realized that although the N1 had arrived as a real quantity on the launch pad at Tyura-Tam, it had much room for improvement, specifically in its use of propellants. An increased payload would allow engineers to amend one of the weakest elements of the N 1-13 plan and increase the crew size from two to three. The late Korolev had persistently tried to create a liquid hydrogen engine development program in the early 1960s, and the effort was finally producing results by 1967–68 with the establishment of a modest production base as well as the first static tests of actual engines.

The model with the best prospects, which began static tests in 1967, was the I1D56 engine with a thrust of seven and a half tons, a creation of the Design Bureau of Chemical Machine Building under Chief Designer Isayev based in Kaliningrad. Two other engines, the I1D54 and I1D57, built by the Saturn Design Bureau under Chief Designer Lyulka, were also approaching the ground testing stage by 1968. A fourth engine, a derivative of the N1's NK-15V motor, was the most powerful of the lot: it was a 200-ton-thrust engine proposed by N1 engine architect Chief Designer Kuznetsov. This engine was, however, far behind in its development curve than the others. Possible applications of the Kuznetsov engine on future variants of the N1 were discussed only in January 1968. Each of the four engines had a specific application in a modernized N1:

- The NK-15V would replace the current engines in Blok B (stage II).
- The I1D54 would replace the current engines in Blok V (stage III).
- The I1D57 in the new Blok S would replace the current Blok G (stage IV).
- The I1D56 in the new Blok R would replace the current Blok D (stage V).¹³²

Perhaps it was the success of the Saturn V or perhaps it was Isayev and Lyulka's progress in developing the engines, but the Soviet liquid hydrogen–liquid oxygen rocket engine program seems to have interested a most unlikely party at this time. After years of vociferously opposing such engine applications in space rocket boosters, in early 1967, Chief Designer Glushko suddenly emerged with an idea for a 200- to 250-ton liquid hydrogen–liquid oxygen engine. The idea was evidently discussed at a ministerial level in January 1968, but by this time, Mishin was not interested in Glushko's reconciliatory gesture.

Proposals for the four engines from Isayev, Lyulka, and Kuznetsov allowed Mishin to table realistic modifications of the N1 in 1967–68. In May 1968, the chief designer had one of his aides prepare a letter to Minister Afanasyev proposing three modifications of the N1—designated the N1F-V2, the N1F-V3, and the N1F-V4—each distinguished by the particular liquid hydrogen stage it used. The N1F-V2 would use a new second stage, the N1F-V3 would use a new third stage, and so on." In August 1968, an "expert commission" consisting of

132. Semenov, ed. *Raketno-Kosmicheskaya Korporatsiya*, p. 262

133. The aide was V. K. Bezverbiy. TsKBEM engineers had begun work on modernized variants of the N1 prior to Korolev's death. Korolev had signed a "technical account" on November 9, 1965, that described four primary versions of the N1: the N1U (a variant with better mass characteristics and more reliable engines), the N1F (a model with improved engines on the first and second stages), and the N1M (two radically improved versions with new engines on all three stages). Each of these would also have subvariants, depending on their use of high-performance liquid hydrogen–liquid oxygen engines on the second or third, or both, stages. Their designations included the letter "V" to denote the Russian word for hydrogen ("vodorod") and a number to denote the stage application. These subvariants were the N1U-V3, the N1F-V3, the N1M-V3 (two different versions), the N1F-V2/V3, and the N1M-V2/V3. Lifting capability stretched from ninety-five tons on the N1U to 230 tons on the N1M-V-2/V3. See B. V. Raushenbakh, ed., *S. P. Korolev i ego delo. suet i teni v istorii kosmonavтики izbrannyye trudy i dokumenty* (Moscow, Nauka, 1998), pp. 632–33.

representatives from various other organizations examined the NIF-V3 and NIF-V4 concepts, evidently giving a positive recommendation to both. The latter version, the NIF-V4, was discussed at the Central Committee level the same month, although a formal decision on development was not forthcoming at the time. In their pursuit of high-performance engines, TSKBEM engineers considered many other proposals, including redesigning the Blok D fifth stage for liquid hydrogen, uprating the current first- and second-stage engines for higher thrust and reusability, upper stage nuclear rocket engines, and even combined liquid-lair-compressed engines working on liquid hydrogen for the first stage of the NI.¹³⁴

As the preparations for the first NI launch at last began to pick up, space officials finally addressed a most critical, but often-postponed issue: a training program for cosmonauts for the L3 lunar landing program. In contrast to NASA astronauts who had been involved in lunar operations training for several years already, the Soviets were typically behind on the curve. Air Force Aide Kamanin had agreed on an initial list of six men on September 2, 1966, to prepare for the lunar landing.¹³⁵ Unfortunately for the cosmonauts, they did not do much training; by the end of 1967, there were still no L3 simulators available at the Cosmonaut Training Center. Kamanin claims in his journals that much of this delay in the delivery of simulators had to do with TSKBEM's continuous redesign of the L3 complex, which made it impossible for the prime contractor of the simulators, the Specialized Experimental Design Bureau at the M. M. Gromov Flight-Research Institute, to produce them. Another obstacle was what Kamanin calls the "ideology" of the L3 complex. In the fall of 1966, official documents specified that unlike previous Soviet piloted spacecraft, the L3 would afford cosmonauts a significant degree of control over the course of a mission.¹³⁶ In a year, Mishin's engineers had backed away from this requirement, falling back on Korolev's old adage about having them serve only as passengers. Thus, from the point of view of TSKBEM, L3 cosmonauts could manage with a compressed training program. In their view, civilian engineers from the design bureau would be the best candidates for lunar landing flights.

The issue of L3 simulators and the cosmonaut training program finally came to a head in December 1967 during several meetings between Air Force and TSKBEM representatives. The former were particularly surprised to find that Mishin had canceled contracts for two simulators: a turbo-flier and a V-10 helicopter with LK controls. Mishin's unilateral actions seem to have seriously raised the wrath of many officials, who were increasingly tiring of the chief designer's somewhat abrasive ways. Eventually by December 15, two deputy chief designers at TSKBEM, Tregub and Tsybin, agreed in principle to a new list of twenty cosmonauts, consisting of ten civilian engineers and ten military officers under Air Force command. TSKBEM and Air Force officials also came to a preliminary agreement on a list of simulators needed for the landing.¹³⁷

¹³⁴ The last concept is mentioned in Semenov ed. *Raketno-Kosmicheskaya Korporatsiya* p. 279

¹³⁵ The men were Yu. A. Gagarin, V. V. Corbatko, Ye. V. Khrunov, A. A. Leonov, A. C. Nikolayev, and V. A. Shatalov. See N. Kamanin, "A Coal Worth Working for" (English title), *Vozdushnyi transport* 45 (1993) 8-9

¹³⁶ Kamanin, "A Coal Worth Working for" no. 47

¹³⁷ The civilians were K. P. Feoktistov, C. M. Crechko, V. N. Kubasov, O. C. Makarov, V. P. Nikitskiy, V. I. Sevastyanov, N. N. Rukavishnikov, V. N. Volkov, V. I. Yazdovskiy, and A. S. Yeliseyev. The military officers were V. F. Bykovskiy, A. V. Filipchenko, V. V. Corbatko, Ye. V. Khrunov, A. P. Kuklin, A. A. Leonov, A. C. Nikolayev, G. S. Shonin, V. A. Voloshin, and B. V. Volynov. By December 26, Nikitskiy and Voloshin had been replaced by V. Ye. Bugrov and P. I. Klimuk, respectively, although the latter two did not effectively join the group until February 1968. See Kamanin, "A Coal Worth Working for" no. 48. Note that TSKBEM had evidently established its own group of cosmonauts for the L3 program earlier on August 18, 1967. These six cosmonauts were S. N. Anokhin, V. Ye. Bugrov, C. A. Dolgopolov, V. P. Nikitskiy, V. I. Patsayev, and V. A. Yazdovskiy. See I. A. Marinin and S. Kh. Shamsutdinov, "Soviet Programs for Lunar Flights."

The eighteen-member L3 group, commanded by the ubiquitous Aleksey A. Leonov, finally began preliminary training in January 1968, later joined by two others the following month. On March 13, Air Force Commander-in-Chief Marshal Konstantin A. Vershinin signed off on a two-and-a-half-year-long training program for these men. At the time, the first L3 missions in Earth orbit were set for late 1968. The first lunar landing, under normal circumstances, was expected in the 1970-71 period, although most designers desperately still clung to the hope of carrying out the mission by late 1969. The shift to 1970-71 was evidence of a marked but subtle feeling among most Soviet space officials that it would be all but impossible for NASA to fulfill Kennedy's goal of landing an American on the Moon before the end of the decade. This belief was not without validity. By March 1968, NASA had still to recover from the Apollo 1 tragedy and was months away from flying a piloted Apollo spacecraft in Earth orbit, let alone in lunar orbit. Many Soviet officials believed that it would take a miracle to successfully carry out a sequential series of completely successful piloted Apollo missions in the perhaps fourteen months leading to a first landing. In many ways, the Soviets were viewing American capabilities through the prism of their own record. Failures were simply an accepted part of testing systems in space for the Soviets. In a diary entry in March 1968, Kamanin wrote:

It took us three extra years to build the N1 and the L3, which let the United States take the lead. The Americans have already carried out the first test flight of a lunar spacecraft, and in 1969 they plan to perform five manned flights under the Apollo program. It is worth noting that there are bottlenecks in the American program—I mean the use of liquid hydrogen as fuel for the second and third stages of the Saturn V and of pure oxygen inside the Apollo. So far hydrogen has been successfully "working" for the United States, but it may throw them back as was the case with oxygen which let them down, causing the death of three astronauts in January of last year."

But the Soviets did not count on the fact that Apollo was one of the most thoroughly ground-tested programs in the history of the U.S. space program. They could not and did not anticipate that Apollo would fail to fail.

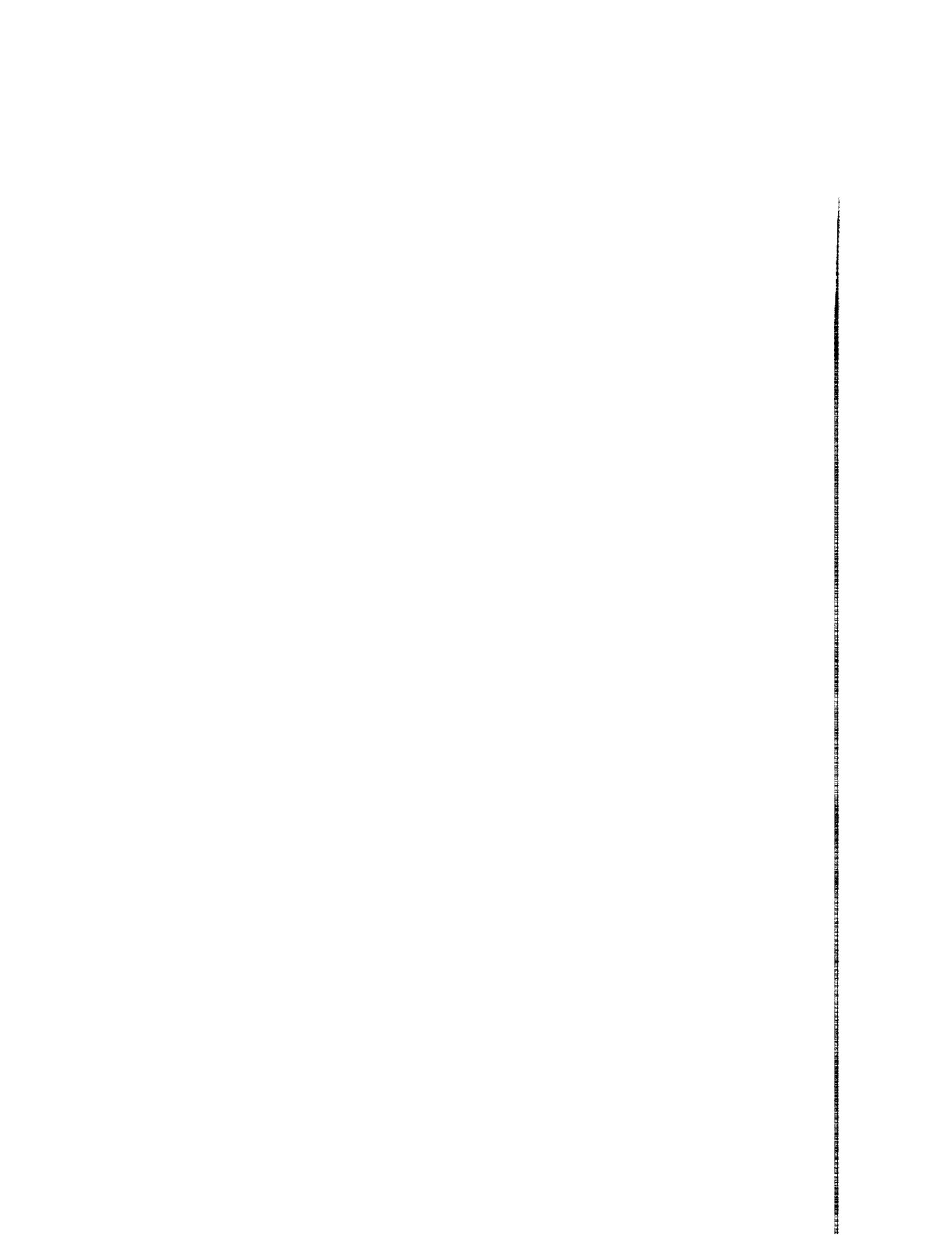



CHAPTER FIFTEEN FINAL LAP TO THE MOON

Through the ten years after Sputnik, two powerful nations engaged in a competition whose underpinnings had as much to do with ideology as it did with strategic power. Space was, of course, only one component of this race, and some would argue less important in its immediate ramifications than the ideological and often bloody confrontations played out all across the world. But when John F. Kennedy's singular pronouncement in 1961 changed the tenor of the space race from one of the grander conquest of space to the less encompassing and more specific reach for the Moon, the meaning of space also changed. For a brief period in the 1960s, for most people, space exploration did not immediately bring to mind images of communications satellites, weather pictures, interplanetary probes, or even military fortifications. It was the Moon that caught the eye—the Moon, always mystical in nature, but now imbued with earthly concerns and earthly rivalries. For many, he who would reach the Moon first would not lay claim to the Moon, but rather Earth itself. As such, the last gasp to the finish line from September 1968 to July 1969 was as remarkable as anything ever seen before in the history of space exploration.

Return to Flight

As the summer gave way to the fall in 1968, the record of the Soviet piloted circumlunar program was dismal. Original plans were to carry out four automated lunar flights before flying cosmonauts around the Moon. In the four attempts since late 1967, there had been three complete failures and one partial success, the deep space mission of Zond 4 in March 1968. To add insult to injury, another L1 spacecraft had been destroyed during ground preparations for a launch in July 1968, delaying flight plans by several months. The first of the three remaining 7K-L1 spacecraft arrived at the Baykonur Cosmodrome to inaugurate a new series of attempts beginning with the lunar launch window in September 1968. The pace and results of ground preparations would determine the possibility of launching L1 missions in the October, November, and December windows.

L1 State Commission Chairman Tyulin, accompanied by Kamanin and a number of L1 cosmonauts, including Bykovskiy and Popovich, arrived at Tyura-Tam on September 10, 1968, for the launch, set for just after midnight on September 15. Kamanin appointed Bykovskiy, one of the leading contenders to command the first lunar mission, to be in charge of controlling preparations for the new launch. As the most experienced Soviet cosmonaut, he had recently, on July 11, been appointed commander of the cosmonaut detachment.¹ On the morning of

¹ The "real" designation of the cosmonaut detachment was military unit no. 26266. See Sergey A. Voevodin, *VSA053* October 23, 1994, an electronic newsletter available at NASA History Office, NASA Headquarters, Washington, DC, file on cosmonauts.

September 13, there were reports from representatives of the search-and-rescue services for the L1 spacecraft. Resources were evidently very limited at the backup site in the Indian Ocean, primarily as a result of financial constraints; the State Planning Organ, responsible for budget appropriations, had recently cut monies for the service by half. If the spacecraft splashed down in the Indian Ocean, it would be during night time on September 21, making the recovery even more difficult with the limited resources at hand, especially because the L1 descent apparatus had no light beacon. Later in the day, the L1 State Commission met at a new three-story building at site 81 near the Proton launching pad. Deputy Chief Designers Trufanov and Shabarov, responsible for the booster and spacecraft, respectively, confirmed that all was ready for a successful circumlunar flight.¹

The 7K-L1 spacecraft no. 9 carried a most interesting assortment of biological payloads to allow doctors to prepare for a piloted circumlunar mission. The central component of the payload was a set of two Steppe tortoises (*Testudo horsfieldi* Gray), each with a mass of 0.34-0.4 kilograms. As part of the experiment, there were two other tortoises in the control group and four more that were left untouched. Soviet doctors picked tortoises over other animals because they did not need complex systems for "security" and also "the method of fixing them on board spacecraft [could] be stringent." The two flight tortoises were placed in the spacecraft on September 2, at which time their food supply was terminated. Physicians would study the deprivation of food until the recovery of the spaceship, to study the pathomorphological and histochemical changes in the animals over the course of several weeks. Apart from tortoises, spacecraft no. 9 also carried hundreds of *drosophila* eggs of the Domodedovo-32 line, air-dried cells of wheat, barley, pea, pine, carrot, and tomatoes, a flowering plant of *Tradescantia paludosa*, three different strains of chlorella, and a culture of lysogenic bacteria.⁴

The launch was perfect. The Proton booster lifted off just 0.07 seconds late, at 0042 hours, 10.77 seconds Moscow Time on September 15, 1968. With the Moon suspended squarely above the pad, the rocket gained speed as it sped into the night sky. At an altitude of 160 kilometers, the third stage switched off as planned, letting the booster coast up. After an agonizing 251-second interval, Blok D switched on as planned and fired for a nominal 108 seconds to insert the stack into a perfect Earth orbit of 191 by 219 kilometers. After a circuit around Earth, about sixty-seven minutes after launch, Blok D fired successfully a second time to impart sufficient velocity to its payload to send it toward the Moon. After the translunar-injection maneuver, the Soviet press finally announced the launch, designating the mission Zond 5. It was the first time in the circumlunar program that a spacecraft had been successfully sent toward the Moon.

While the initial results from the flight were encouraging, as it progressed, there were some malfunctions that threatened to destroy any hope of a complete success. During the outbound flight to the Moon, ground controllers at the main flight control center at Yevpatoriya discovered that the 100K stellar attitude control sensor had failed. Later diagnosis showed that the failure was a result of a contamination of the sensor's optical surface from residue released by

2 N Kamanin "A Coal Worth Working for" (English title) *Vozdushniy transport* 50 (1993) 10-11

3 N A Gaidamakin G P Parfenov V G Petrukhin V V Antinov P P Saksonov and A V Smirnova "Pathomorphological and Histochemical Changes in the Organs of Tortoises Carried on Board the Spacecraft Zond 5" (English title) *Kosmicheskiye issledovaniya* 7 (November-December 1969) 93 1-39

4 O G Cazenko V V Antipov and C P Parfenov "Results of Biological Investigations Undertaken on the Zond 5 Zond 6 and Zond 7 Stations" (English title) *Kosmicheskiye issledovaniya* 9 (July-August 1971) 601-09 The payload was evidently carried in a 150 kilogram cone and also included instruments for the study of radiation primary cosmic rays the composition of the solar atmosphere and photometry of several stars See Christian Lardier *L'Astronautique Soviétique* (Paris Armand Colin 1992) p 161

the heat given off from the interior coating. With one sensor malfunctioning, positioning the vehicle for mid-course corrections became a difficult proposition. Upon hearing news of the failure. Chief Designer Mishin and State Commission Chairman Tyulin flew to Yevpatoriya from the Baykonur Cosmodrome to direct compensatory measures, joining a group of cosmonauts. Including Bykovskiy and Popovich, who were already at the center. On the morning of September 17, controllers were able to use the less accurate solar and Earth orientation sensors to maneuver the spacecraft successfully to carry out the first mid-course correction, sufficient to make the vehicle circle the Moon and head directly toward the Earth. At the time of the firing, at 0611 hours Moscow Time, Zond 5 was at a distance of 325,000 kilometers from Earth.⁵

The spacecraft circled around the far side of the Moon at a distance of 1,960 kilometers from the surface and was flung onto a return trajectory toward Earth. Special cameras took high-quality photographs of Earth from a distance of 90,000 kilometers, which were, in fact, the first complete pictures of Earth from the Moon, three months before Apollo astronauts returned with similar photographs. On the night of September 19–20, the British astronomical observatory at Jodrell Bank monitored transmissions from Zond 5 and picked up a Russian voice calling out instrument values from the spacecraft.⁶ At the time, observers believed that the voice was prerecorded, but more than likely, cosmonauts, including Popovich at Yevpatoriya, were playing the role of a real crew by transmitting their reports via the spacecraft.

Zond 5's journey back was a difficult and challenging ordeal for ground controllers. To the alarm of the flight control team, the 101K Earth sensor also failed at the time. The problem was later traced back to incorrect procedures during the spacecraft's preparation at the technical complex. There was evidently an error in the operational documentation that caused the sensor to fall out of coordination with the mechanical operation of the spacecraft's main omnidirectional antenna. To make matters worse, the three-axis stabilization platform spuriously switched off the guided reentry system. With all these failures, there was little hope that the spacecraft could carry out a guided reentry onto Soviet territory because that would require a highly precise attitude during the firing of the main engine. Engineers instead focused on bringing the vehicle back on a ballistic trajectory into the Indian Ocean using the remaining 99K solar sensor in conjunction with the smaller attitude control thrusters. Over the course of twenty hours, controllers at Yevpatoriya fed a series of singular commands to "swing" the ship from one side to the other, so that the resulting thrusts of the two engines would fire in the direction of Earth. After alternately turning on the small thrusters on each side of the vehicle, the ship gathered enough velocity and hit a tiny thin corridor in Earth's atmosphere for a ballistic reentry into the Indian Ocean.⁷

Tensions were high at both control centers, the primary one at Yevpatoriya and the supporting one located at the Ministry of General Machine Building's Coordination-Computation Center at TsNII Mash, next door to Mishin's design bureau. A number of high-level officials, including Georgiy N. Pashkov, a Deputy Chairman of the Military-Industrial Commission, and Maj. General Andrey G. Karas, the Commander of the Central Directorate of Space Assets, were present for the reentry at the center. Air Force representative Kamanin, who was also present, summarized the possible fate of Zond 5 as controllers watched their terminals:

5. Kamanin, "A Goal Worth Working for". Yu. P. Semenov, ed. *Raketno-Kosmicheskaya Korporatsiya "Energiya" imeni S. P. Koroleva* (Korolev. RKK *Energiya* named after S. P. Korolev. 1996). pp. 243–44. V. P. Glushko, ed., *Kosmonavtrka entsiklopediya* (Moscow: Sovetskaya entsiklopediya, 1985). p. 130.

6. Kenneth Gatland, *Robot Explorers* (London: MacMillan, 1972). p. 141. Some reports also suggest that a second mid-course correction was effected on the return trip. See Glushko, ed., *Kosmonavtrka entsiklopediya*. p. 130.

7. Semenov, ed., *Raketno-Kosmicheskaya Korporatsiya*. pp. 244, 354. Note that there were two 99K solar sensors on the ship. One of them had failed to turn on, leaving a single solar sensor available for use.

The spacecraft, according to estimates, should enter the atmosphere at an angle of 5–6 degrees to the local horizon. Even minus one degree in the reentry angle would mean that Earth's atmosphere would fail to "catch" the spacecraft. Even one degree would increase the g-load by 10–16 units *above* the estimated 30–40 units, and a greater angle would be dangerous not only for the crew, but may also destroy the spacecraft. In other words, the spacecraft should fly over 800,000 kilometers *along* the Earth-Moon-Earth route at a speed of 11 kilometers per second and hit the zone ("funnel") of safe entry 13 kilometers in *diameter*. Such high precision can be compared only to that of *hitting* a one-kopek coin from a 600 meter distance."

To the credit of the resourceful ground controllers at Yevpatoriya, the ship slipped perfectly through its intended corridor into Earth's atmosphere. Within three minutes of the splash-down at 1908 hours Moscow Time on September 21, the commander of the search-and-rescue service, Air Force Maj. General Kutasin, reported that Zond 5 had landed 105 kilometers from the nearest Soviet ship in the Indian Ocean.⁸ The first flight of a spacecraft to the Moon and back had lasted six days, eighteen hours, and twenty-four minutes.

The rescue of the Zond 5 descent apparatus was complicated not only by the nighttime conditions but by the presence of some uninvited guests. U.S. Navy vessels were in the area at the time, evidently to observe the recovery process and to collect information on the Zond spacecraft. The lingering U.S. ships caused undue anxiety back at Yevpatoriya, especially for "flight director" Pavel A. Agadzhanov, the chief of the Chief Operations and Control Group, who did not want to compromise the secrecy of the landing. It took the *Borovichi*, an Academy of Sciences ship equipped with radio direction finders and powerful searchlights, several hours to find the capsule in the rough seas. Rescuers then lifted the 2,046-kilogram capsule onto the ship's deck and covered it with a large tarpaulin. The American ships left within minutes of having observed the recovery.⁹ After recovery, an oceanography ship, the *Vasilii Golovin*, carried the spacecraft to Bombay on October 3, where it was packed into a container to hide its appearance. Officials drove the capsule to the airport, from where it was flown directly to Moscow on an An-12 aircraft. Through it all, the tortoises survived their ordeal, despite enduring a rough sea landing. The descent apparatus, including the animals, arrived in Moscow on October 7; four days later, doctors were able to finally begin their medical analysis.¹⁰

8 Kamanin 'A Goal Worth Working for' p. 10. Others present at the Coordination Computation Center included K. P. Feoktistov (Department Deputy Chief TsKBEM) and A. G. Mrykin (First Deputy Director TsNIIMash).

9 The exact location of the landing was 32°38' S by 65°33' E.

10 B. A. Pokrovskiy *Kosmos nachinayetsya na zemlye* (Moscow Patriot, 1996) pp. 283–84. Curiously the CIA in its report on the recovery of Zond 5 stated: "The spacecraft splashed down late on 21 September after completing a seven day flight around the Moon. Soviet recovery ships were unable to locate the vehicle for some ten hours and it was another three hours—mid morning—before they recovered it. A U.S. destroyer observed this first Soviet water recovery at close range." See Peter Pesavento "Two Weeks That Killed the Soviet Dream" *New Scientist* (December 18, 1993) 29–32.

11 *Soviet Space Programs 1966–70: Goals and Purposes, Organization, Resources, Facilities and Hardware, Manned and Unmanned Flight Programs, Bioastronautics, Civil and Military Applications, Projections of Future Plans, Attitudes Toward International Cooperation and Space Law*, prepared for the Committee on Aeronautical and Space Sciences, U.S. Senate 92d Cong. 1st sess. (Washington, DC: U.S. Government Printing Office, December 1971) p. 242.

12 Gaidamakin *et al.* "Pathomorphological and Histochemical Changes." According to their analysis: "The effects of space flight in conjunction with starvation produced changes mainly of atrophy type in the organs of the animals." In addition: "Starvation at the space center (of tortoises of a control group) led to less pronounced atrophy of the tissue. Comparison of the changes which occurred in the test and control animals indicates that the main structural changes in the tortoises were caused by starvation and to a lesser degree by the action of the flight factors."

The Zond 5 mission, despite its attendant flaws, was the first unequivocal success in the L1 program. It allowed Tyulin and Mishin to seriously plan on flying a crew on a circumlunar mission in January 1969, contingent upon two more successful L1 flights. By the time Zond 5 splashed down in the Indian Ocean, there were three lunar launch windows left before 1969—in October, November, and December. Based on the pace of preparations, Mishin hoped to fly L1 spacecraft no. 12 in November and spacecraft no. 13 in December. The ship and cosmonauts for a piloted flight would be ready in January. Such a schedule would still fulfill the original mandate of flying four robotic spacecraft before a crewed attempt.

Crews for the piloted mission had nearly completed their training program by this time, with a final spurt during the Zond 5 flight, when some of the L1 cosmonauts trained at Feodosiya. On September 27, Kamanin and Mishin agreed to three final crews for the first circumlunar mission. With any luck, one of these crews would make history as the first humans to fly from Earth to the Moon. The crews were:

- Crew 1: Aleksey A. Leonov and Oleg G. Makarov
- Crew 2: Valeriy F. Bykovskiy and Nikolay N. Rukavishnikov
- Crew 3: Pavel R. Popovich and Vitaliy I. Sevastyanov

All three crews were judged to be equally prepared for the flight, although it seems that Kamanin had favored the Bykovskiy crew as the primary candidates for the first outbound mission. As with all other Soviet piloted missions, a final decision on the issue was expected at the State Commission meetings prior to launch. Each of the three crews also had a single understudy—Anatoliy P. Kuklin, Petr I. Klimuk, and Valeriy A. Voloshin, respectively. The three backup cosmonauts were trained and ready to step into either the commander's or flight engineer's position in case a primary crewmember was indisposed."

The nine men training for a circumlunar mission were not the only cosmonauts preparing for spaceflight in the fall of 1968. By August 1968, trainees Beregovoy, Volynov, and Shatalov had completed training for the first piloted Soyuz mission since the Soyuz 1 tragedy more than a year before. In the autumn of 1968, Ivan I. Utkin, the chair of the subcommission investigating the accident, finally declared the Soyuz landing system completely ready for piloted flight.¹⁴ Less by plan than by coincidence, Chief Designer Mishin set the "return to flight" Soyuz mission in time for the fifty-first anniversary of the Great October Revolution. The flight plan was for one cosmonaut in an active Soyuz to link up with a passive automated Soyuz. The two ships would remain docked for a few hours before separating and carrying out independent missions. The conservative rendezvous and docking flight would then open the way for the long-delayed EVA transfer attempt. There was one major difference on this mission from the previous "rehearsal" docking missions of Kosmos-186/188 and Kosmos-2121/213; in this case, engineers decided to launch the passive instead of the active vehicle first. The older profile was clearly more suited for simulating operations in lunar orbit when the active LOK would await the passive LK after it had lifted off from the Moon. The Soviets themselves have never revealed the reasons for this unusual switch. Perhaps it was dictated by engineering concerns over checking the operation of the *Igla* rendezvous radar system before committing to a piloted mission. Less likely, but certainly possible, it may have been TsKBEM's attempt at rehearsing an Earth-orbit rendezvous for a lunar landing mission in case the NI was not deemed safe for carrying cosmonauts into orbit. Such a prospect was, in fact, given serious consideration throughout 1968–69.

¹³ Kamanin. "A Goal Worth Working for" On September 24, three days before the final decision, Kamanin was leaning toward the following crews: A. A. Leonov/A. F. Voronov, V. F. Bykovskiy/N. N. Rukavishnikov, and P. R. Popovich/O. G. Makarov. Obviously, this crew composition was modified by September 27.

¹⁴ Semenov, ed., *Raketno-Kosmicheskaya Korporatsiya*, p. 183



This meeting of the State Commission occurred prior to the Soyuz 3 mission in October 1968. Sitting at left are Commission Chairman Kerim Kerimov and Chief Designer Vasily Mishin. Standing next to Mishin is Air Force Aide Nikolay Kamanin. Standing next to Kamanin from left to right are cosmonauts Georgiy Beregovoy (primary) Vladimir Shatalov and Boris Volynov. Sitting on the extreme right is Marshal Sergey Rudenko, a Deputy Commander-in-Chief of the Soviet Air Force. (copyright Christian Lardier)

The Soviet political leadership was particularly anxious to resume space missions after the long gap, particularly because of NASA's well-publicized launch of Apollo 7 on October 11, 1968. It was the first crewed U.S. spaceflight since the Apollo 1 fire in January 1967. A few days after the Apollo 7 launch, Mishin met with Communist Party General Secretary Brezhnev to brief him on the state of various projects at TsKBEM, including the N1-L3, Soyuz, and RT-2 ICBM programs. Mishin also spoke to Minister of General Machine Building Afanasyev by telephone after arriving at the launch site. The two Soyuz missions were set for mid-October 1968, but there were numerous malfunctions during prelaunch testing, which prompted Afanasyev to order Mishin to delay the launches. On October 23, the day after the Apollo 7 crew's splash-down, the State Commission for Soyuz met at the Baykonur Cosmodrome to discuss preparations for the Soviet launches. Kamanin presented cosmonaut Beregovoy as the primary candidate, with Shatalov and Volynov as his backups. There seems to have been some serious doubt as to Beregovoy's qualifications for the flight. He had failed his prelaunch examination, receiving a "2" ("bad") out of a possible "5" ("excellent"). Instead of flying his backup Shatalov, Air Force officials organized a second examination, in which Beregovoy managed to get "4" ("good")." All three men—Beregovoy, Shatalov, and Volynov—had trained for the Voskhod 3 flight in 1966, whose cancellation had been one of Mishin's first actions after his official appointment as chief designer. Another issue at the meeting was what to call the first automated 7K-OK vehicle in the press—that is, whether to give it a nondescript "Kosmos" designation to hide its true mission or to bestow it with the Soyuz moniker. Commission

15 | Izvekova and Afanasyev. "How From a Failure Was Forged the Next Victory" (English title) *Noustr kosmonautiki* 23124 (1998) 64-66

CHALLENGE TO APOLLO

members agreed to call the spacecraft Soyuz 2, but to announce it only after the launch of Beregovoy with Soyuz 3.

The 7K-OK spacecraft no. 11 lifted off successfully from site 1 at the Baykonur Cosmodrome at noon on October 25, 1968. The initial orbital parameters were 185 by 224 kilometers at a 51.7-degree inclination. All systems aboard the automated Soyuz spaceship seemed to be working without fault, but conservatism crept into the proceedings. Chief Designer Mnatsakanyan of the Moscow-based Scientific-Research Institute for Precision Instruments recalls that on the night of the first launch, thirteen members from the Chief Operations and Control Group at Yevpatoriya sent a telegram to him at the Tyura-Tam control center to drop the idea of docking on the mission and simply try a two-part rendezvous—first to thirty kilometers and then down to 100–200 meters. The abrupt change in plans was evidently motivated by a lack of confidence in the Igla radar system, whose chief architect was Mnatsakanyan. By his own account, the chief designer had no one to consult, and he unilaterally decided to reject their recommendation, taking full responsibility for the decision."

The following day at 1134 hours Moscow Time, as the target vehicle passed over the launch site, the 7K-OK spacecraft no. 10 lifted off with Colonel Georgiy T. Beregovoy aboard. It was the first-ever piloted launch from site 31, the second launch complex at the Baykonur Cosmodrome built for launch vehicles derived from the old R-7 ICBM. At forty-seven years old, Beregovoy was the oldest person to venture into space at the time. His initial orbital parameters were 205 by 225 kilometers also at a 51.7-degree inclination. Soon after the launch, the Soviet press announced Beregovoy's mission as *Soyuz 3* and the target as *Soyuz 2*.

On Soyuz 3's first orbit, ground controllers switched the Igla rendezvous system into operation, bringing the vehicle to a distance of only 200 meters from the Soyuz 2 target after at least two orbital corrections. At that point, as external TV cameras beamed down images to Earth, test pilot Beregovoy took over manual control to bring his spacecraft in for a docking. As he closed into a range of forty to fifty meters, his spaceship automatically banked 180 degrees from the target despite his best attempts to compensate for the guidance system." After the sudden failure, the two ships moved apart while several senior officials, including Minister Afanasyev, Academician Keldysh, Col. General Kamanin, Space Assets Commander Maj. General Karas, and Chief Designer Mishin, flew to Yevpatoriya from the launch site. There was evidently some controversy on whether the docking failure was the result of an Igla system failure. Mnatsakanyan insisted that his system worked flawlessly and that:

the cosmonaut had been confused by the light beacons [on the target spacecraft], and thereby [had maneuvered his spacecraft in such a way] that a certain angle had been formed between the antennas of the [two] ships, causing the [active] ship to "turn away" to one side."

Later analysis confirmed Mnatsakanyan's hunch and clearly pointed to pilot error as the primary reason for the failure. Once the Igla system had brought Soyuz 3 to within 200 meters of Soyuz 2, Beregovoy took over manual control. At that point, the two ships were still not aligned perfectly. However, instead of gingerly stabilizing his ship along a direct axis to the target, Beregovoy used a stronger firing to put his spacecraft into a completely incorrect orientation relative to the target. The passive Soyuz 2's radar system, sensing the improper deviation, automatically turned its nose away from Soyuz 3 to prevent an incorrect docking.

16. Yu. A. Mozzhorin, et al., eds., *Dorogi v kosmos II* (Moscow, MAI, 1992), p. 35
17. Semenov, ed., *Raketno-Kosmicheskaya Korporatsiya*, p. 190.
18. Mozzhorin, *Dorogi v kosmos II*, p. 35.

Beregovoy, not sensing the real problem, completed a fly-around, and then tried to approach the target a second time. The same thing happened again. In the process, he practically exhausted all the propellant remaining for orientation. Because there was barely enough propellant remaining for reentry only, any further docking attempts had to be called off."

After the initial rendezvous. Beregovoy retreated from Soyuz 2, and throughout the remainder of the day, the ships drifted 565 kilometers apart. At the end of his work day, on Soyuz 3's fifth orbit, the cosmonaut moved into the spheroid living compartment at the forward end of the ship and began his sleep period."

On October 27, after waking up, Beregovoy exercised for about twenty-five minutes before beginning his day's activities. Perhaps taking a cue from the recent live transmissions from the Apollo 7 spaceship, the State Commission allowed Beregovoy to "host" a TV performance later that day that was beamed down to Soviet television, providing the public their first view of the interior of the Soyuz spaceship. Viewers saw the cosmonaut wearing a woolen training suit and a white helmet with earphones as he spoke of the comfort afforded by the new spaceship. The following morning, the automated Soyuz 2 spacecraft separated into its component parts, and despite a malfunctioning astro-orientation sensor, the descent apparatus carried out a successful guided reentry, landing at 1056 hours Moscow Time near the target region in Kazakhstan. The parachute system worked without fault. On October 28, Beregovoy devoted his time to a modest suite of scientific and Earth observation experiments. He carried out:

observations of the stellar sky, the earth, and other heavenly bodies: detected the storm centers of typhoons and cyclones on the earth's surface: made reports to earth on fires in forests and jungles. studied the brightness of the earth's surface; photographed its cloud cover and snow cover: and photographed its *horizon* in daylight and twilight."

This last experiment involved taking photographs using photometrically marked black-and-white film with orange-colored light filters."

After midday, Beregovoy performed a second TV transmission for public benefit, pointing out instrumentation within the vehicle. One orbital maneuver the same day on the thirty-sixth orbit changed his orbit to 199 by 244 kilometers. His fourth working day began on October 29 at 0345 hours Moscow Time, and it culminated with his third public TV broadcast, during which he gave viewers a look through the portholes in the Soyuz. There were evidently no anomalies during the flight, and the cosmonaut worked without interruption on his experimental observations. He maintained a good appetite throughout the mission and did not display any sign of disorientation, although he later admitted that it took him about twelve hours to get fully used to the weightless state.

Soyuz-3's reentry program was the source of great anxiety at the control centers, not the least because it was the first piloted return to Earth since Komarov's tragic death. After an initial aborted attempt, Beregovoy fired his main engine for 145 seconds over the Atlantic

19 Izvekoy and Afanasyev "How From a Failure Was Forged the Next Victory" As a comparison during the twenty minutes of the automatic portion of the rendezvous Soyuz 3 used only thirty kilograms of propellant. In the ensuing two minutes Beregovoy used up forty kilograms after which there were only eight to ten kilograms remaining sufficient for only one reentry attempt

20 Evgeny Riabchikov *Russians in Space* (Moscow: Novosti Press Publishing House, 1971) p. 244. Peter Smolders *Soviets in Space* (New York: Taplinger Publishing Co., 1973) p. 163.

21 Riabchikov *Russians in Space* p. 245

22 G. V. Rozenberg and A. B. Sandomirsky "Altitude Variation of the Scattering Coefficient from Spaceship Soyuz 3 Measurements and Aerosol Stratification" in K. Ya. Kondratyev, M. J. Rycroft, and C. Sagan, eds. *Cospar Space Research XI, Volume I* (Berlin: Akademie Verlag, 1971) pp. 633-38.

Ocean to brake from orbit on the morning of October 30. Flying over Africa and then the Caspian Sea, the descent apparatus successfully carried out a guided reentry landing at 1025 hours Moscow Time near Karaganda in Kazakhstan. Luckily for Beregovoy, a blizzard at the landing area had passed by morning time, and the cosmonaut landed safely on a snow-covered steppe, welcomed by a bewildered local boy on a donkey." During a three-day, twenty-two-hour, fifty-minute, forty-five-second mission. Beregovoy had circled the Earth sixty-four times. While his flight may not have been completely successful, the Soyuz 2/3 mission was a significant boost to the confidence of engineers working on the program. Almost every single automated system aboard the Soyuz 3 spacecraft, including the Igla rendezvous system, the life support systems, the main engine, the attitude control sensors, and the parachute landing system, worked flawlessly. Beregovoy's postflight report on October 31 to the State Commission was illuminating. He recalled that payload fairing jettisoning was "unpleasant." Once in orbit, there were problems with the viewports: the right viewport was fogged up from the exterior, and there was dust between the glasses of the viewports. In general, Beregovoy reported that there was a lot of dust in the descent apparatus. Most critically, he reported that the manual control during the approach to Soyuz 2 was "too sensitive," implying that the "human automation" dynamics had room for improvement. When asked later by the press whether his age had made it difficult for him to be chosen for the mission. Beregovoy replied that his height (180 centimeters) had been more of a problem than anything else."

Crew-rating the Soyuz spacecraft was critically important for the future of the Soviet space program, but for immediate purposes, the focus was on the Moon—in particular, the L1 circumlunar program. Delays in the preparation of the next flight-ready L1 vehicle had forced Mishin to skip the October 13–15 lunar launch window, thus shifting the launch into November. With rumors on the possibility of an Apollo lunar-orbital mission circulating in the Western press, Soviet public spokespersons suddenly found themselves in a difficult position. As a result, throughout October and November, Soviet officials expressed often contradictory positions on their policy on the "race to the Moon." On October 14, Academician Sedov, representing the Soviet Union at the 19th Congress of the International Astronautical Federation in New York, in a clear obfuscation of the truth, stated that "the question of sending astronauts to the Moon at this time is not an item on our agenda. The exploration of the Moon is possible, but is not a priority." Then, as if to contradict himself, he added that "the program for the exploration of the Moon depends upon the success [of the Zond] experiments. Since the experiments may have various results, it is not possible at this time to be positive about lunar landings."

The press conference for the Soyuz 3 mission, held on November 5, was also an interesting exercise in public relations. Despite hesitance on talking about lunar plans, Academician Keldysh was forced by the numerous questions from journalists to finally concede that the Soyuz spacecraft was not designed for a flight around the Moon. He strongly implied that the Soviets were not planning a piloted flight around the Moon in the near future. It was the first step on the slow and painful road for the Soviets in their cover-up of the piloted lunar programs. After years of vociferously voicing opinions in favor of crewed lunar operations, Soviet spokespersons were all of a sudden caught in a web of confusion, having to emphasize that they were not interested in the Moon while confirming as such, often in the very same sentence. Keldysh, for example, added at the Soyuz 3 press conference that before cosmonauts

23 Riabchikov. *Russians in Space*, pp. 243–44; Smolders. *Soviets in Space*, pp. 165–66.

24 Reginald Turnill. *The Observer's Book of Manned Spaceflight* (London: Frederick Warne & Co. 1975).

p 132

25. "Russian Denies Moon Race Is On." *New York Times* October 15, 1968. p. 48

26 *Ibid*

actually carried out a lunar landing, a complete mission from liftoff to lunar landing and return to Earth would be carried out automatically. The Soyuz 3 mission itself was the subject of a lie: when a journalist asked Beregovoy why he had not docked with the Soyuz 2 spaceship, the cosmonaut replied calmly, "That was not on the program." No doubt, he was only saying what his "handlers" had asked him to say. As if to confirm that the Soviets were finally backing away from any public association with the Moon, Academician Sedov emphatically announced during a visit to the University of Tennessee Space Institute on November 7 that the "U.S.S.R. would not conduct manned lunar operations within the following six months."

Apollo Versus Zond

In this penultimate lap toward the Moon, the tenor of the competition between the Soviet Union and the United States dramatically changed in the late fall of 1968 with the fast pace of events in the Apollo program. U.S. space officials had been carefully watching Soviet accomplishments throughout the year for hints of their ambitions toward the Moon. Circumlunar missions had been raised in classified CIA briefs as early as April 1967, and it was no surprise to U.S. observers when Zond 5 successfully carried out its flight exactly as predicted. The CIA, in a top-secret "National Intelligence Estimate" on the Soviet space program dating from April 1968, claimed that the Soviets might attempt a piloted circumlunar mission by "the last half of 1968."²⁷ One senior NASA astronaut, Frank Borman, recalls that in early August, news of the Soviet deadline of late 1968 had trickled down from the CIA to NASA, prompting NASA officials to establish a more ambitious timetable for Apollo.²⁸ In the alphabetical sequence of Apollo missions, the "C" mission (Apollo 7) in Earth orbit was to be followed by the "D" mission (Apollo 8), the first flight of the combined Command and Service Module with the Lunar Module, also in Earth orbit. The "E" mission (Apollo 9) would then be a Lunar Module test in high-Earth orbit.

In early August 1968, George M. Low, the Deputy Director of NASA's Manned Spacecraft Center in Houston, ordered his staff to work on a plan to eliminate the "E" mission in favor of the much more ambitious "C-prime" flight—one in which an Apollo Command and Service Module launched on a Saturn V would go directly to lunar orbit. It was a decision laden with risks. It would only be the third launch of the Saturn V booster, and the risks of a lunar-orbital mission would be exponentially more than one in Earth orbit. But based on their analysis, Low and Air Force General Samuel C. Phillips, Apollo program manager at NASA Headquarters, were willing to commit. As NASA historian Roger D. Launius accurately observed in retrospect:

The advantages of this could be important, both in technical and scientific knowledge gained as well as in a public demonstration of what the United States could achieve. So far Apollo had been all promise: now the delivery was about to begin.'

27 "Soyuz 3 Moon Trip Called Unlikely" *New York Times* November 6 1968 p 44 Soviet Space Programs 1966-70 p 370

28 NASA Science and Technology Division *Astronautics and Aeronautics* 1968 *Chronology of Science Technology and Policy* (Washington DC NASA Special Publication (SP) 4010 1969) p 267

29 U.S. Central Intelligence Agency "National Intelligence Estimate 11-1-67 The Soviet Space Program" Washington DC April 4 1968 p 2 as declassified in 1997 by the CIA Historical Review Program

30 Frank Borman and R. J. Sterling *Countdown An Autobiography* (New York William Morrow 1988) p 189

31 Roger Launius *NASA A History of the U.S. Civil Space Program* (Malabar FL Krieger Publishing Co 1994) pp 89-90

By mid-August, the Manned Spacecraft Center received clearance from NASA Headquarters on the new plan; a final decision was still contingent upon the success of the initial piloted Apollo mission in Earth orbit, then slated for October 1968. If Apollo 7 was an unequivocal success, NASA would move ahead to the lunar-orbital Apollo 8 in December."

On October 11, 1968, NASA launched Apollo 7 into Earth orbit with three astronauts. After a highly successful eleven-day flight, the crew splashed down safely in the Pacific Ocean. NASA management's case for lunar orbit in December was further bolstered by the outstanding achievement of Zond 5, which had successfully circled the Moon and splashed down in the Indian Ocean. There was little doubt among independent observers that the Soviets were targeting the Moon for a piloted circumlunar flight, possibly for their lunar launch window, also in December 1968. On November 11, Phillips composed a final memorandum on launching Apollo 8 to lunar orbit, and Acting NASA Administrator Thomas O. Paine announced it publicly a day later."

By early November, the Soviets were still planning two more automated L1 missions, one in mid-November and one in early December, to be followed by a piloted launch in January. The question begs itself: Once the Apollo 8 announcement was made public by NASA, did Soviet officials consider skipping one of the precursor flights and moving the piloted launch to December? The Soviets had a significant advantage. To have the best lighting conditions for potential lunar landing sites for future missions, NASA officials had set the Apollo 8 launch window for December 21, 1968. Because of differences in trajectories, the circumlunar launch window for a Soviet launch from central Asia would be earlier in the month, around December 8-10. Thus, launching cosmonauts to the Moon in December would guarantee a first-place finish at a time when the rivalry between the two space programs was approaching a climactic finish. But contrary to a plethora of speculation in the West, there was, in fact, no real plan for a December 1968 piloted launch to preempt Apollo 8.³⁴

Cosmonauts, chief designers, and military officials arrived at Tyura-Tam in early November to direct the preparations for the launch of the 7K-L1 spacecraft no. 12. The launch went off without incident at 2211 hours, 31 seconds Moscow Time on November 10, 1968. Within sixty-seven minutes of the launch, the Blok D upper stage successfully fired to boost the spacecraft, named Zond 6 by the Soviet press, toward the Moon. As soon as the spacecraft was on its way to the Moon, controllers discovered that an antenna boom had not deployed, effectively preventing operation of the stellar attitude control sensor mounted on the boom. Despite the problem, ground controllers managed to command the vehicle to perform its first mid-course correction at a distance of 246,000 kilometers from Earth on the morning of November 12 using a backup stellar attitude control sensor that used the Sun and Sirius as fixed points. Flying what seemed to be a perfect flight, Zond 6 flew around the far side of the Moon two days later at a closest distance of 2,420 kilometers.

A camera on the spacecraft took high-resolution black-and-white photographs of the Moon from distances of 11,000 and 3,300 kilometers. The first session was intended for filming the lighted surface of the Moon for measuring its photometric characteristics and determining its amount

³² For a discussion of the switch to "C prime" see also William David Compton *Where No Man Has Gone Before: A History of Lunar Exploration Missions* (Washington DC: NASA SP 4214, 1989) pp 132-33. Donald K. Deke, Slayton with Michael Cassutt, *Deke! U.S. Manned Space: From Mercury to the Shuttle* (New York: Forge, 1994) pp 213-16.

³³ This memorandum of General Samuel is reproduced in full as "Reading No. 15: NASA Decides to Make a Circumlunar Apollo Flight" in Launius, NASA, *A History of the U.S. Civil Space Program* pp 207-10.

³⁴ Col. General N. P. Kamanin's diaries confirm as such. On November 9, 1968, he wrote "We have two more test launches to complete the program of preparing a piloted flight around the Moon." These two test launches were planned for mid-November and early December 1968. Later on November 10, 1968, Kamanin wrote that "our flight around the Moon with a crew on board is scheduled for the first half of 1969." See N. Kamanin, "I Feel Sorry for Our Guys" (English title) *Vozdushnyi transport* 12 (1993): 11.

and form. The closer shots enabled large-scale photography for photometric measurements and the mapping of hidden portions of the Moon. The camera used panchromatic film and had a focal length of 400 millimeters; it produced frame sizes of thirteen by eighteen centimeters. Stereo imaging was made possible by the angles of some of the images. The photographs covered areas of the Moon both visible from Earth and on the far side. Apart from the camera, Zond 6 also carried a photo-emulsion detector to record the paths of cosmic rays, as well as another device to measure micrometeoroid impacts." The spacecraft also carried biological specimens, although the Soviets have never provided any details. These possibly included tortoises, *Drosophila*, *Tradescantia* plants, bulbs of the *Allium* series, dried wheat germs, various strains of chlorella, *B. coli*, and other samples. Explicit mention was only made of air-dried cells of wheat, barley, peas, pine, carrots, and tomatoes."

After the spacecraft circled the Moon, controllers had to refine the trajectory of Zond 6 sufficiently to allow it to perform a guided reentry into Earth's atmosphere and land on Soviet territory instead of the Indian Ocean. The first correction was successfully accomplished on the morning of November 16 at a distance of 236,000 kilometers from Earth. It looked as if everything was on track for a perfect mission until sometime the same day when ground controllers detected a disastrous problem: the air pressure within the descent apparatus had dropped from a normal level of 760 mm Hg down to 380 mm, indicating a compromise of the spacecraft's integrity. There was also an associated drop in temperature within the hydrogen peroxide tanks for reentry attitude control. Despite the partial depressurization, later found to be the result of a faulty rubber gasket, the critical systems on the ship remained operational, and the controllers were able to carry out the third and final mid-course correction, just eight and a half hours prior to reentry at a distance of 120,000 kilometers from Earth on the morning of November 17. Zond 6 separated into its two component modules prior to reentry, and at 1658 hours Moscow Time the same day, the descent apparatus entered its tiny entry corridor into Earth's atmosphere at a velocity of 11.2 kilometers per second. Passing through its 9,000-kilometer-long reentry corridor, it skipped out of the atmosphere, having reduced velocity down to 7.6 kilometers per second, and began a second reentry that further lowered velocity to only 200 meters per second. Throughout the reentry, engines on the descent apparatus automatically fired to vary roll control so as to change lift force and reduce g-loads. Unlike its predecessor, the Zond 6 descent apparatus was subjected to a maximum of four to seven g's.³⁵ The complex reentry was a remarkable demonstration of the precision of the L1 reentry profile.

The guided reentry may have been successful, but the depressurization problem was a failure difficult to ignore. During part of the descent, pressure in the descent apparatus reduced further down to only twenty-five millimeters, certainly killing any biological payloads on board. No doubt, a crew within the ship would have experienced the same fate. The near-total depressurization caused the gamma-ray altimeter of the descent apparatus to issue a false command to release the single parachute system, whose container was also depressurized, at an altitude

35 Glushko ed *Kosmonautika entsiklopediya* p 130 *Soviet Space Programs 1966-70* p 243 Note that more recent Russian accounts state that the lunar photography was carried out at distances of 8,000 and 2,600 kilometers. See Semenov ed *Raketno Kosmicheskaya Korporatsiya* p 245 The pictures had a resolution of fifty lines per millimeter

36 One Soviet source implies at several points that the biological payloads for Zond 6 were almost but not completely identical to Zond 5. See Gazenko, Antipov, and Parfenov, "Results of Biological Investigations."

37 Semenov ed *Raketno Kosmicheskaya Korporatsiya* p 245

38 Glushko ed *Kosmonautika entsiklopediya* p 130 G. V. Petrovich ed *The Soviet Encyclopaedia of Space Flight* (Moscow: Mir Publishers, 1969) pp 513-14 I. B. Afanasyev "Unknown Spacecraft (From the History of the Soviet Space Program)" (English title) *Nouye v zhizni Nouye tekhniki Seriya kosmonautika astronomyya* no. 12 (December 1991) 1-64

of 5,300 meters above the ground instead of much later. Without a parachute, the ship simply plummeted down to the ground and smashed into pieces. Remarkably, the impact occurred only sixteen kilometers from the Proton launch pad at the Baykonur Cosmodrome, where Zond 6 had lifted off just six days and nineteen hours previously."

What lay ahead for rescuers was yet another situation fraught with danger. The crushed descent apparatus clearly had a lot of valuable materials, including the in-flight data recorder as well as exposed film from the Zond 6 camera, which possibly could have survived the crash. On the other hand, the capsule contained ten kilograms of TNT, whose condition was unknown and which would pose a threat to any recovery operation. Groups from TsKBEM and the Scientific-Research Institute for Automated Devices arrived at the site on the day of the crash, followed by Deputy Chief Designer Bushuyev the following day, November 18. The plan was to extract all available recoverables from the broken chassis of the spacecraft with manual tools, but without striking any blows to the ship. It was a long, step-by-step, and arduous process, but rescuers eventually dismantled the explosive system and handed it over to an Air Force team, which later blew it up in a nearby steppe. For their demanding work, Chief Designer Mishin personally ordered commendations for all rescuers. A cursory inspection of the remains of the descent apparatus showed that the parachute system had indeed been jettisoned; moreover, the main undeployed antenna boom had remained attached to the capsule through reentry instead of being automatically discarded prior to entry into the atmosphere, although this did not affect the success of its guided reentry. Among the items recovered intact from the wreckage was the exposed film from the Zond 6 camera. Beautiful pictures of both Earth and the Moon were later published in the journals, serving to confirm Soviet assertions that everything about the flight had been successful. While all the biological specimens had been killed, Soviet scientists were able to glean information from some of the seedlings on board."

Following the Zond 6 crash, Mishin postponed any plans for a piloted LI mission in the near future: the dreams of Soviet engineers and scientists of circling the Moon prior to the United States also went up in smoke. It was the final and ignominious end of three years of intensive work—work plagued by unprecedented delays and failures. It was not a pretty picture for the Soviets in November 1968. Given the results of Zond 6, an automated launch would have to be skipped for the December launch window. The next available window was in January 1969. If and only if that mission was completely successful, officials could hope for a piloted circumlunar mission for the next window, perhaps in March or April 1969. Kamanin wrote in his diary on November 26, 1968:

I have to admit that we are haunted by U.S. intentions to send three astronauts on board Apollo 8 around the Moon in December. Three of our unpiloted LI spacecraft have returned to Earth at the second cosmic velocity, two of them having flown around the Moon. We know everything about the Earth-Moon-Earth route, but we still don't think it is possible to send people on that route."

39. Semenov, ed. *Raketno-Kosmicheskaya Korporatsiya*, p. 245; Afanasyev. "Unknown Spacecraft." The parachute system was evidently discarded at the time that the "frontal shield" for the descent apparatus was jettisoned. See Major I. Kuznetsov. "The Flight That Did Not Occur" (English title). *Aviatsiya i kosmonautika* no. 8 (August 1990) 44–45. In the final conclusion on the Zond 6 failures TsKBEM engineers believed that two problems—the drop in temperature in the hydrogen peroxide tank to minus five degrees Centigrade and the capsule depressurization—were related events. After the temperature drop on the night of November 14, engineers had attempted to heat the tank by facing it toward the Sun. The excess heat evidently affected the weak seal of the main hatch and led to slow decompression.

40. Semenov, ed. *Raketno-Kosmicheskaya Korporatsiya*, p. 246; Cazenko, Antipov, and Parfenov. "Results of Biological Investigations."

41. Kamanin, "I Feel Sorry for Our Guys," no. 12.

Ironically, it was the same day that the Soviet press for the first time explicitly connected the Zond circumlunar flights to a *piloted* space project. A journalist wrote in *Soviet News*. "[The] space station Zond 6, like Zond 4 and Zond 5, was launched in order to improve the automatic functioning of manned spaceship which will be sent to the Moon."⁴² It was a particularly curious time for such an admission, especially because the LI program was at its nadir then, with little prospect of a piloted mission in the near future.

The Impending launch of Apollo 8 on December 21 raised the ante of the space race to a dramatic level, especially in the public forum. Many mainstream Western publications reported that the Soviets were planning to go ahead with a piloted circumlunar launch on December 8.⁴¹ Early in December, the popular magazine *Newsweek* quoted "U.S. sources" claiming that the Soviets would "default because of unspecified technical problems with their Zond spaceship."⁴⁴ A week later, the same magazine asserted that:

*Intelligence sources confirm that the Soviet Union was ready but unable to send a manned mission to the moon earlier this month when the launch window was open. Unspecified technical difficulties developed in the Zond spacecraft. In the past week, the Soviet space tracking and recovery ships in the Indian Ocean have dispersed or returned to port*⁴⁵

These rumors contributed to a veritable cottage industry of stories that the Soviets had prepared a booster and that cosmonauts had been ready on the launch pad going through a count-down, which had been canceled at the last moment. The evidence, however, suggests that there was no such attempt, nor were there plans for such a launch, at least on the part of senior officials and designers. The cosmonauts training for the LI, however, apparently had other ideas.

Civilian cosmonaut Sevastyanov, an engineer on one of the three crews training for the circumlunar mission, recalls that the LI group of six cosmonauts wrote a letter directly to the Politburo asking for permission to fly to the Moon in December. They argued that despite all the failures on Zond 5 and Zond 6, the presence of a crew aboard the ship would make a flight more safe. Their proposed mission would begin with a launch on December 9, with sufficient time to beat Apollo 8. According to Sevastyanov, despite the absence of permission from higher officials, the cosmonauts flew to Tyura-Tam during the first days of December and were there for more than a week. The Proton booster and the 7K-LI spacecraft no. 13 were ready in the assembly-testing building, apparently the same articles that had been planned for a robotic flight in December before the Zond 6 failure. With zero support from most space officials, the cosmonauts never received permission to fly.⁴⁶ Given the inordinate levels of confusing information concerning Soviet space history, Sevastyanov's account is probably purely apocryphal. As evidenced by

42 Phillip S. Clark. "Topics Connected With the Soviet Manned Lunar Programme." *Journal of the British Interplanetary Society* 40 (May 1987): 235-39. See also Donald C. Winston. "Soviets Admit Zond 6 Manned Capability." *Aviation Week & Space Technology*, December 2, 1968, pp. 18-19. A prominent article in the official Soviet government newspaper *Izvestiya* also highlighted the possibility of a Soviet piloted circumlunar mission as a result of the "success" of Zond 6. See "Russians Cite Readiness for Manned Lunar Flights," *New York Times*, November 26, 1968, p. 4.

43 See, for example, "Radiating Confidence," *Aviation Week & Space Technology*, December 2, 1968, p. 15.

44 "Soviet Moon Shot Postponed?," *Newsweek* (December 16, 1968): 24.

45 "Soviet Moon Shot That Fizzled," *Newsweek* (December 30, 1968) 11. See also "Cosmos 260 Launched," *New York Times*, December 18, 1968, p. 35.

46 I. A. Marinin and S. Kh. Sharnsutdinov. "Soviet Programs for Lunar Flights" (English title), *Zemlya i use-lennaya* no. 4 (July-August 1993) 62-69; S. Sharnsutdinov and I. Marinin, "Flights Which Never Happened: The Lunar Program" (English title), *Aviatsiya i kosmonautika* no. 2 (February 1993) 30-31.

Kamanin's personal journals, the cosmonaut overseer was not even at Tyura-Tam on December 8. Instead spending the day at the Cosmonaut Training Center in Moscow overseeing minor bureaucratic issues unrelated to the lunar program." True or not. Sevastyanov's story adds to the mythology of the Soviet space program, growing ever more richer and imaginative year by year.

As the Apollo 8 launch grew closer. Soviet spokespersons for the space program began their efforts to neutralize what was threatening to become a public relations disaster. In a propaganda offensive that would last a year. Soviet officials engaged in a complete about-turn, backing away from their insistent statements of years before. Veteran cosmonaut Titov, on a trip to Bulgaria, told journalists the day before the Apollo 8 launch. "it is not important to mankind who will reach the Moon first and when he will reach it—in 1969 or 1970."⁴⁸ But matter it did. When Apollo 8 lifted from Cape Kennedy on December 21, 1968. the eyes of world were upon the three astronauts. Colonel Frank Borman, Captain James A. Lovell, Jr., and Lt. Colonel William A. Anders, who were embarking on a journey as important as any in history—to leave the bonds of Earth and head out into deep space. For many Soviets, it was a bittersweet day. Kamanin wrote in his diary:

*The flight of Apollo 8 to the Moon is an event of worldwide and historic proportions. This is a time for festivities for everyone in the world. But for us, the holiday is darkened with the realization of lost opportunities and with sadness that today the men flying to the Moon are not named Valeriy Bykouskiy. Pavel Popovich, nor Aleksey Leonov, but rather Frank Borman, James Lovell, and William Anders.*⁴⁹

The Apollo 8 Command Module splashed down in the Pacific Ocean on December 27, 1968, after a mission successful beyond the best of hopes, during which the crew had circled the Moon ten times. After years of uncertainty and a lack of self-confidence, the United States had convincingly taken a dramatic lead over its only competitor. The time for payback had arrived for both countries. For the United States, it was payback for excellent management, high levels of funding, and a state-level commitment; for the Soviet Union, it was precisely the opposite. In their meager responses to Apollo 8, Soviet spokespersons weakly defended their positions. Academician Sedov, still referred to as the "father of the Sputnik," told Italian journalists a day after the Apollo 8 splashdown that the Soviets had not been competing in a race to orbit or land on the Moon. Referring to Apollo 8, he added:

*There does not exist at present a similar project in our program. In the near future we will not send a man around the moon. We start from the principle that certain problems can be resolved with the use of automatic soundings. I believe that in the next 10 years vehicles without men on board will be the first source of knowledge for the examination of celestial bodies less near to us. To this end we are perfecting our techniques.*⁵⁰

Automation was a big theme in Soviet public statements throughout 1969. The topic was prominent at a meeting of the Military-industrial Commission on December 30, 1968, to discuss

47 N. Kamanin, "For Him. Living Meant Flying" (English title). *Vozdushniy transport* 18-19 (1994): 12 Even more damaging for the Sevastyanov story. Kamanin on December 5-6 had spent the days off at his dacha resting and "clearing paths of snow -

48. *Soviet Space Programs, 1966-70*, p. 371

49. Lev Kamanin. "From the Earth to the Moon and Back" (English title). *Poisk* 12 (July 1989) 7-8 See also Abe Dane. "The Moon Mission That Wasn't." *Popular Mechanics* (March 1990). 38-39.

50 "Soviet Space Aide Denies Moon Race," *Washington Post*, December 29, 1968, p. A4.

a response to Apollo 8. Grasping at straws, commission members decided to move ahead with one possible glimmer of light at the time: the Ye-8-5 robot spacecraft capable of recovering soil samples from the surface of the Moon. Kamanin had a cynical view of the exercise, writing:

They cannot possibly get into their heads the very simple thought that it is impossible to answer the piloted flight of Apollo 8 with a flight of an automatic machine . . . any automatic machine cannot possibly be a satisfactory answer. Only landing people on the Moon and successfully recovering them on Earth would serve as an answer to the triumph of Apollo 8. But we are not ready for an expedition to the Moon, in the best case we will be ready for such a flight in about 2-3 years."

As with many other lunar projects at the time, there was much still unknown about the Ye-8-5; engineers at Chief Designer Babakin's design bureau had not even built a complete model of the spaceship by the end of the year. Regardless, the Central Committee and the USSR Council of Ministers issued a new decree, no. 19-10, on January 8, 1969, titled "On the Work Plans for Research of the Moon, Venus, and Mars by Automatic Stations."⁵¹ The decree evidently called for the acceleration of various automated programs, including the Ye-8-5 robot. It was the first clear response to Apollo 8, and it established a new direction in Soviet space policy that would remain entrenched for many years to come. Handed their biggest defeat yet, officials now went about neutralizing the effects of the Apollo victory by claiming that the Soviet Union had never intended to reach the Moon. It was clearly much easier to change history when the details of that history were originally obscured or hidden beyond recognition.

Transfer in Orbit

When the Soviets were finally ready to carry out their long-delayed docking and EVA Soyuz mission, it was already an anachronism. Originally, Korolev had conceived such flights as means to master rendezvous, docking, EVA, long-duration missions, and other complex operations in Earth orbit to provide expertise for future piloted lunar excursions. It would serve in much the same capacity as Gemini did for Apollo in the U.S. space program. To extend the analogy, by the time the Soviets were ready to fly *their* Gemini, the United States was already flying Apollo. In fact, much of the technology used on the Soyuz was different from that on the L3. For example, cosmonauts would use the *Yastreb* EVA suits on Soyuz unlike the *Orlan* and *Krechet-94* on the L3. The Soyuz used the Igla rendezvous radar system, while the L3 used Kontakt. The actual docking contraptions were completely different, and the launch vehicles had no common elements. Still, it was an important step in moving slowly to piloted lunar operations by providing crucial experience to ground controllers, cosmonauts, and designers in performing complex operations in Earth orbit.

Rumors about the mission were bolstered in November 1968 when Mishin, under cover as the anonymous "Chief Designer," spoke to Soviet journalists about the assembly of two Soyuz spacecraft in orbit.⁵² Preparations for the missions culminated in a meeting at Tyura-Tam of the Soyuz State Commission on January 11, 1969. Kamanin presented the two primary and two backup crews to the commission for final approval.⁵⁴ Like no other crew before, the four

51 N Kamanin "I Feel Sorry for Our Guys" (English title) *Vozdushnyi transport* 13 (1993) 8-9

52 *Ibid*

53 Donald C. Winston "Soyuz Series Aims for Orbital Platform" *Aviation Week & Space Technology* November 18 1968 pp 121-23

54 Kamanin "I Feel Sorry for Our Guys" no 13

members of the primary crew, all rookies, each had distinctive backgrounds, breaking tradition with earlier Soviet cosmonauts. The commander of the active spacecraft was Vladimir Aleksandrovich Shatalov, the first of a new generation of Soviet cosmonauts to fly into space. Born in Petropavlovsk in Kazakhstan on December 8, 1927, he had graduated with distinction from the Red Banner Air Force Academy with honors in 1956. When training to become a test pilot in the early 1960s, Shatalov applied for admission into the ranks of cosmonauts at a time when the Air Force was expanding its pool base from young, inexperienced pilots to accomplished engineering-test pilots with graduate degrees. It seems that Shatalov had been the top ranked in the group of fifteen military officers selected in January 1963. The light-haired and powerfully built man had plenty of experience preparing for space missions. He would have flown on one of the later Voskhod missions in 1966 had the program not been canceled. He had also served as ground communicator for the Voskhod, Voskhod 2, and Soyuz 1 flights.⁵⁵

The passive vehicle crew consisted of Volynov, Yeliseyev, and Khrunov. Commander Volynov had served as a backup crewmember for a number of Vostok, Voskhod, and Soyuz missions, and might have commanded Voskhod 3, had it not been canceled only two weeks prior to liftoff. He would also have the honor of being the first Russian Jew to fly into space, a distinction that would posit him in many difficult situations in the future. Both Volynov and Khrunov had joined the cosmonaut detachment in 1960 as part of the famous "Gagarin group," although both had to wait almost nine years for their first chance to fly in space. The self-effacing Khrunov, like Volynov, had also served in important backup positions, including for cosmonaut Leonov during his historic first spacewalk on Voskhod 2 in 1965. The final member of the crew, Yeliseyev, was the first of the new civilian group from TsKBEM, whose candidacy had been pushed so hard by Korolev and then Mishin. On this mission, Khrunov and Yeliseyev would carry out the actual EVA transfer from one Soyuz to another—the mission they had been trained to perform in 1967 on Komarov's ill-fated flight.

On January 13, 1969, Shatalov boarded his ship for the first Soyuz launch, which was set for 1300 hours Moscow Time. Given the fact that Shatalov's home telephone number also ended in "13" and that he was slated to be the thirteenth Soviet cosmonaut, many were a

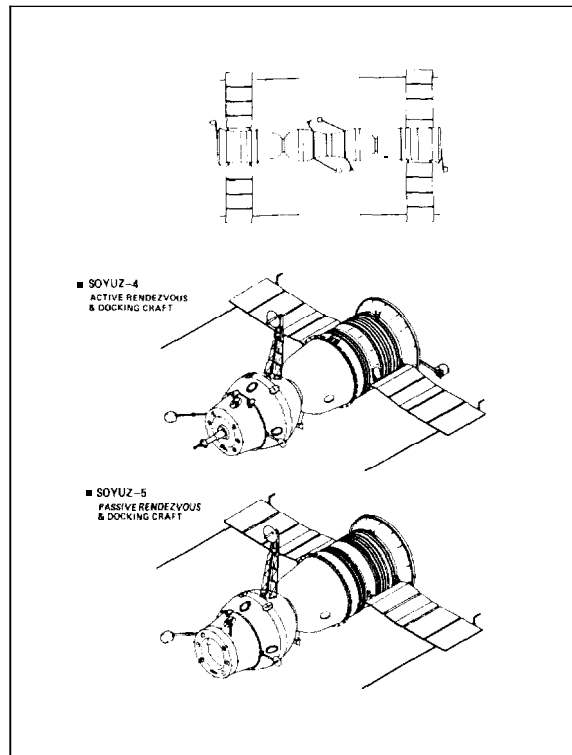

Soviet cosmonauts performed the first docking of two piloted spacecraft in orbit during the Soyuz 4/5 mission in January 1969 (copyright R. F. Gibbons)

⁵⁵ Rex Hall, "Soviet Air Force Cosmonauts," in Michael Cassutt, ed., *Who's Who in Space: The International Space Year Edition* (New York: Macmillan, 1992), p. 261

little apprehensive about the launch. Fortunately for the superstitious, nine minutes prior to liftoff, the countdown abruptly stopped.⁵⁶ There was evidently a failure in a hydraulic system on Blok A of the booster; the State Commission postponed the launch to the following day." It was another freezing day on January 14 when launch operations began for a second launch attempt at pad 31. Witnesses recall the entire launch area being covered with a thick layer of snow. This time, there were no problems. Lt. Colonel Vladimir A. Shatalov, forty-one years old at the time, lifted off at 1032 hours Moscow Time on January 14 in his Soyuz spaceship, vehicle no. 12. The initial orbital parameters of the ship, named *Soyuz 4*, were 173 by 225.3 kilometers with a 51.72-degree inclination. During his initial hours in orbit, Shatalov manually fired the main Soyuz engine on the fifth orbit, about six hours after launch, to change parameters to 207 by 237 kilometers, sharpening his approach trajectory in wait for the target vehicle. He also hosted a television session, which was broadcast to Moscow TV, clearly showing two extra but empty seats in his spaceship, thus arousing speculation that there would be a linkup of some kind in the following days."

The next day, January 15, the 7K-OK spaceship no. 13 lifted off precisely on time at 1005 hours Moscow Time with its three-cosmonaut crew of thirty-four-year-old Lt. Colonel Boris V. Volynov (Commander), thirty-four-year-old civilian Aleksey S. Yeliseyev (Flight Engineer), and thirty-five-year-old Lt. Colonel Yevgeniy V. Khrunov (Research Engineer). The initial orbital parameters of the now-named *Soyuz 5* were 198.7 by 230.2 kilometers at a 51.69-degree inclination. As soon as Soyuz 5 was in orbit, both spacecraft immediately began their program of approach toward each other. In contrast to the original plans for the mission, which envisioned a docking on the very first orbit of the passive ship, the maneuvers were carried out in a much leisurely pace over the period of a day. Volynov on Soyuz 5 fired his main engine on his fifth orbit to change the orbit to 211 by 253 kilometers, thus moving closer to Shatalov's chosen orbit. After a second maneuver by Shatalov on the morning of January 16 on his thirty-second orbit, ground controllers switched on the Igla system at 1037 hours Moscow Time. Through the next half hour, the radar system brought the two vehicles to a distance of only 100 meters. Shatalov later vividly described the program from then on:

At this point, I went over to manual control, and Boris Volynov did the same. The problem was to make sure that the docking units of both spacecraft were properly oriented toward each other. Throughout this time I was manually controlling the appropriate thrusters. With the control stick on the left-hand side I regulated the craft's linear velocity — slowing it down or speeding it up — and damped out the lateral velocity. When we were over the shores of Africa — some seven or eight thousand kilometers from the borders of the Soviet Union — we approached to within (forty meters) of each other and started to hover. At this range, Boris Volynov and I performed several maneuvers.⁵⁷

As he closed in on Soyuz 5, there were some problems, including erroneous signals from the docking control and contact lights, that were apparently related to the spurious activation of the control and diagnostics system on Soyuz 4. At a ginger twenty-five centimeters per second, the two spacecraft hard-docked at 1120 hours to Volynov's exclamation of "Welcome!"⁵⁸

56 M. F. Rebrov *Kosmicheskaya katastrofa. Russkiye sensatsii* (Moscow: Izdat. 1993) pp. 41–42.

57 The launch problem may have occurred because of ground operator error. K. P. Feoktistov recalls that there were "Incorrect actions of ground control" in inputting settings. See *Russian Space History Sale 6516* (New York: Sotheby's, 1993) description for Lot 57.

58 Smolders *Soviets in Space* p. 170.

59 Riabchikov *Russians in Space* p. 256. With his right hand, Shatalov exercised roll control.

60 *Ibid.* p. 257. Smolders *Soviets in Space* pp. 171–172. *Russian Space History*, Lot 57.

One cosmonaut on the passive ship was rumored to have been much more excited. Unconfirmed reports suggest that at the moment of docking, when the pin was inserted in the cone of Soyuz 5, one of the crewmembers on the latter ship shouted out "We're being raped! We're being raped!" While initial TV broadcasts of the segment carried the exclamations intact, all later replays omitted the offending words.⁶¹

After docking, it seems that the two vehicles had suffered excessive rotations because of the problems with the diagnostics system but settled down sufficiently for the cosmonauts to begin preparing for the crew transfer. Somewhat overextending its claims, the Soviet press dramatically announced that the link up of Soyuz 4 and Soyuz 5, a combined mass of 12,924 kilograms, as "the world's first experimental space station."⁶² The complex did, however, have a common power system during the docked duration by means of a plug-and-sockets system on the docking nodes. On the thirty-fifth orbit of Soyuz 4, Khrunov and Yeliseyev began their preparations for their transfer EVA by entering the living compartment of Soyuz



Soyuz 4 Commander Vladimir Shatalov displays how Soyuz 4 and Soyuz 5 docked in Earth orbit in January 1969. It was the first time that two piloted spacecraft docked to each other in space (files of Peter Corin)

5 and unstowing two Yastreb suits from a side cupboard. Commander Volynov assisted them during the procedure, which proved to be relatively difficult with three men in the cramped confines of the module. Each suit had a self-contained backpack attached to one of their legs instead of their waists, as was the case on the earlier Yastreb versions for the abandoned Soyuz 1/2 mission. Both cosmonauts were, however, tethered safely to the spacecraft via umbilicals, which carried lines for communications and health telemetry. In a ceremonial move, Soyuz 5, launched a day after Soyuz 4, had carried into orbit a bunch of mail addressed to Shatalov, as well as a number of newspaper articles on the Soyuz 4 launch. The letters were not only from his family, but also from Minister Afanasyev, Chief Designer Mishin, State Commission Chairman Kerimov, Col. General Kamanin, and others. During the transfer, Khrunov and Yeliseyev were to carry the mail and media materials, presumably in their pockets, in addition to a camera."

After the suits were tested and pressurized, Volynov bid the two cosmonauts goodbye and retreated back into the descent apparatus and shut the intermediary hatch between the two modules before commanding the living compartment to depressurize. Khrunov then opened up the outer hatch of the living compartment on Soyuz 4's thirty-fifth orbit and poked his head out cautiously. After Volynov's final permission to egress, Khrunov moved his body out of the spacecraft, briefly getting entangled in his safety cord. The combined complex was over South America at the time. Khrunov recalled later.

I emerged from the spacecraft without difficulty, and looked around. I was amazed by the marvelous, magnificent spectacle of two spacecraft linked together high above the earth. I could make out every tiny detail on their surfaces. They glittered brilliantly as

61 James E. Oberg *Red Star in Orbit* (New York: Random House, 1981) pp. 98-99

62 Petrovich *The Soviet Encyclopaedia of Space Flight* p. 388

63 Riabchikov *Russians in Space* p. 258 Smolders *Soviets in Space* p. 172

they reflected the sunlight. Right in front of my eyes was *Soyuz-4*, looking *very* much like an aircraft. The big, long spacecraft was like a fuselage, and the solar panels were like *wings*.⁶⁴

Yeliseyev followed after Khrunov, letting the latter lead in EVA activities. Khrunov crawled toward the docking unit of Soyuz 5 and removed a TV camera from a support and turned off its power supply. Before exiting the spacecraft, Yeliseyev had forgotten to fasten a still-photo camera to his suit. The instrument floated out into space, depriving the Soviets of high-quality photographs of the historic event. Among their modest activities during the excursion, the two men also "made observations of the Earth's horizon. [and] checked the operation of the attitude-control jets." Khrunov, followed by Yeliseyev, then moved over to the living compartment of Soyuz 4, opened its hatch, and crawled in. They were received by a welcome note from Shatalov, who was at the time in the spaceship's descent apparatus. After the pressurization of the living compartment, the hatches between the two modules were opened, and Shatalov embraced his comrades, treating them to a toast of black currant juice instead of the customary vodka, which was prohibited aboard the spacecraft. The entire episode had lasted one hour, although the two cosmonauts had been out of the spacecraft for thirty-seven minutes.

Wasting little time, the two commanders, Shatalov and Volynov, began immediately to prepare for undocking. At 1554 hours, just four hours and thirty-four minutes after docking, the two spacecraft separated and went on their own ways. Soyuz 4 now with three cosmonauts and Soyuz 5 with one. They had been joined together for three orbits. In continuing their independent missions, the crews carried out a number of scientific experiments, which included the use of a new stellar-navigation sextant, the operation of the RSS-1 spectrograph for geophysical studies, and the testing of instrumentation for medical and biological experiments. Earth observational experiments included observing and photographing terrestrial cloud cover, storm formations, snow and ice cover, and various geological structures. One set of activities included astronomical investigations, such as observing the astral sky during both day and night, photographing the night sky in a direction opposite the Sun, and studying the initial stages of the development of comet tails. The RSS-1, on Soyuz 5, was used for a spectrophotometry experiment on Earth's twilight aureole over a spectral range of 400-650 nanometers on the second and fifteenth orbits from a mean altitude of 240 kilometers. Khrunov also carried out experiments related to the passage of radio waves through the ionosphere. Finally, both Soyuz 4 and Soyuz 5 carried special targets on the exterior for measurements of tritium and helium-3. Each target consisted of a package of fourteen plates made from one sheet of aluminum.⁶⁶

Soyuz 4 was the first to return from orbit. On January 17, Shatalov, Yeliseyev, and Khrunov carried out a guided reentry, landing at 0953 hours Moscow Time, forty kilometers northwest of the town of Karaganda in Kazakhstan. The mission had lasted two days, twenty-three hours, twenty minutes, and 47 seconds. Volynov, now alone, had a much more difficult time, facing perhaps the most dramatic and dangerous reentry in the history of the Soviet space program. During the early morning of January 18, in preparation for his reentry around midday, Volynov reported that all systems were fine aboard the ship. At 1020 hours, he passed over the Gulf of

64 Rrabchikov *Russians in Space* p 259

65 *Ibid* pp 259-60

66 I A Alimova V O Nardenov B S Boltenkov and V N Cartmanov 'Measurement of Tritium and Helium 3 in Aluminum Targets' (English title) *Kosmicheskiye issledovaniya* 9 (January-February 1971) 149-51
K Ya Kondratyev A A Buznikov B V Vinogradov V N Volkov V V Corbatko and O I Smotky 'Spectrophotometry of the Earth From Manned Spacecraft' in Kondratyev Rycroft and Sagan eds *Cospar Volume 1* pp 619-32 Smolders *Soviets in Space* p 175 Lardier *L'Astronautique Soviétique* pp 187-88 G S Narmanov ed *Ot kosmicheskikh korably k orbitalnym stantsiyam* (Moscow Mashinostroyeniye 1971) pp 65-66

Guinea near Africa before firing the 55.35 engine for the predetermined period. Six seconds after the termination of retrofire, Volynov heard the pyrocartridges triggering to separate the three major modules of the spacecraft: the living compartment, the descent apparatus, and the instrument-aggregate compartment. As he looked through the viewport, he noticed something deadly wrong: he could clearly see the antennas attached to the solar arrays on the cylindrical instrument-aggregate compartment, meaning that the section, also known as the service module, had not separated from the descent apparatus. While similar failures had occurred on early Vostok and Voskhod flights, it posed a much greater threat on Soyuz because of the relatively huge size of the module. Volynov immediately reported in code to ground controllers about his predicament. Most simply believed that Volynov had little chance to live.⁶⁷

The descent apparatus tumbled in somersaults as it remained attached to the three-ton service module and began its long journey through the atmosphere. Turning over and over, with the thermal shield unexposed to the heat because it was still covered by the service module, the heat began to affect unprotected portions of the descent apparatus. Smoke began to appear within the capsule as the light heat insulation began to burn. Normally, during a reentry, hydrogen peroxide jets would fire during this period to guide the capsule to provide lift and reduce thermal and gravitational stresses. In this case, Volynov noticed that his instrument panel indicated that the valves for the thrusters were open, but there had been no firings. All the propellant had been used up at the initiation of retrofire, when the computer had tried in vain to correct the spaceship's incorrect attitude.

Volynov recalls that he was sure that only a few minutes separated him from death. The normally unflappable cosmonaut considered saying goodbye to his relatives, but instead decided to hurriedly save all the recorded materials on the docking procedure by ripping the important pages from the log book, rolling them up tightly, and sticking them into the middle of the book. Then, amid the cauldron around him, he calmly began to speak into a tape recorder, describing all the details of his experience to assist in identifying the reasons for the failure. Through it all, there were terrifying moments. Once, there was a sharp clap, indicating that the propellant tanks of the service module had blown apart with such force that the crew hatch was forced inwards and then upwards like the bottom of a tin can. Plummeting through a ballistic trajectory, he realized that the service module had finally disintegrated and he had survived. His relief soon turned to anxiety when the parachute system triggered at an altitude of ten kilometers. The straps on the main parachute began to twist, preventing them from unfurling properly. For the second time in minutes, he was convinced of his end. Remarkably, the braids of the parachute began to untwist slowly: by the time that the descent apparatus landed with its soft-landing engines, it was sufficient to ensure Volynov's safety, although the landing was so hard that the roots of his teeth in his upper jaw were broken off. It was only the specially built shock-absorbing seat that saved him from broken bones and more serious injuries.⁶⁸

The Soyuz 5 descent apparatus landed 600 kilometers from its originally intended landing site, 200 kilometers southwest of Kustanay. TASS only announced that "the flight took place successfully, a unique experiment was conducted, and the vehicle touched down in the designated area." Volynov landed at 1108 hours Moscow Time on January 18, after a three-day, fifty-four-minute, fifteen-second mission. In their investigation of the Soyuz 5 reentry, TsKBEM engineers found that the connection locks between the descent apparatus and the instrument-aggregate compartment had failed to release. The two modules finally separated from each other when the intermediary transfer compartment, carrying hydrogen peroxide tanks for the attitude control thrusters, exploded. Despite the dangerous situations, the designers were

67 Mikhail Rebrov "A Difficult Re Entry From Orbit" (English title) *Krasnaya zvezda* April 27 1996 p 5

68 *Ibid*

extremely pleased with the performance of the descent apparatus, which had withstood temperatures and stresses far above nominal during the reentry and specifically ensured the safety of the crew in a sudden switch from a guided to a ballistic reentry. The mission also confirmed the correctness in using an advanced titanium frame for the descent apparatus, as well as the propitiousness of countless design and statistical tests to ensure the stability of the capsule with any angle of attack.⁶⁹

In spite of the near catastrophe at the end of the flight, the Soyuz 4/5 mission was a landmark flight in the Soviet space program. It was not only the first docking of two piloted spacecraft in space and the first transfer of a crew in orbit from one spacecraft to another, but also the first completely successful piloted space mission in the post-Korolev era. While the mission had been accomplished nearly two years late, the complexity of the flight indicated a certain maturity in Soviet space operations from the almost primitive Voskhod missions during Korolev's last years. Still, compared to the U.S. space program, it was a poor match. NASA astronauts had accomplished the first docking in space as early as March 1966 on Gemini VIII. Even the Soviets themselves had already accomplished automated docking twice in orbit. But after the humiliating defeat of Apollo 8, the Soviet leadership was willing to take anything remotely successful as a godsend. What was at best an interesting and moderately complex operation in Earth orbit was made out to be the most dramatic step in the exploration of space. At the subsequent press conference for the Soyuz 415 cosmonauts, the Soviets made much of the fact that the docked complex had been the world's first "experimental orbital station." In one of the few interesting moments of the presentation, cosmonaut Khrunov let out that "in the design of our spacesuits certain aspects of Leonov's suit were taken into consideration. Our experiences on this flight may well contribute to the designs of a moon suit."⁷⁰

There was a bizarre postscript to the Soyuz 415 mission. On January 22, a number of famous cosmonauts, including Nikolayev, Tereshkova, Leonov, and Beregovoy, were being driven to the Kremlin for an awards reception in the back of a Zil limousine. As they entered the gates of the Kremlin, a man in a hat and dark glasses stepped from the shadows with a gun in each hand and began firing at the limousine with the cosmonauts. He managed to fatally wound the driver. Leonov remembers:

I looked down and saw two bullet holes on each side of my coat where the bullets passed through. A fifth bullet passed so close to my face I could feel it go by. This man was shooting at me, thinking that I was Brezhnev. He was angry because he had been conscripted into the army. When it was over, Brezhnev took me aside and told me "Those bullets were not meant for you, Aleksei. They were meant for me, and for that I apologize."⁷¹

The man, a young army lieutenant named Ilyin, was apprehended and later spent twenty years in a special prison.

Dazed and Confused

More than any other U.S. space achievement of the 1960s, the flight of Apollo 8 froze the Soviet space industry into a kind of collective shock. Nothing the Soviet Union was capable of doing in December 1968 could have been neutralized the worldwide accolades for the impressive achievement of Borman, Lovell, and Anders. If the Communist Party was only too eager to

69 Semenov, ed., *Raketno-Kosmicheskaya Korporatsiya*, p. 184

70 Smolders, *Soviets in Space*, p. 176.

71 Thomas O'Toole, "The Man Who Didn't Walk on the Moon," *New York Times Magazine*, July 17, 1994, pp. 26-29

use space achievements as a means to sell the virtues of socialism in the early 1960s, now Soviet officials were almost embarrassed by it. In this backdrop, senior Soviet space officials convened in January 1969 to discuss not only an adequate response to the U.S. space program, but also to talk in general about the larger direction of their entire piloted space effort.

The first meeting, presided over by Minister of General Machine Building Sergey A. Afanasyev, was held on January 10 amid the cold snowy weather at Tyura-Tam, just a few days prior to the Soyuz 4/5 launches. Among those present were all the members of the Council of Chief Designers involved in lunar programs, as well as deputy chief designers and department heads from many design bureaus and institutes." Afanasyev was aghast. He asked the distinguished assemblage, perhaps, rhetorically. "How can we get out of this mess?!" The primary questions at hand were:

- How should the success of Apollo 8 be neutralized in the short term?
- What should be done with the L1 circumlunar program now that its importance had been all but neutralized by Apollo 8?
- How should the L3 landing project proceed, and was there any way the USSR could beat an American landing?
- How should the N1 be modified to improve its capabilities for the future of the Soviet space program?"

On the first point, the Party and government had just passed a resolution accelerating the Ye-8-5 sample returner project. In a compensatory measure to allay public opinion, many senior Soviet government officials were shifting their thinking to automation. Kamanin emphasized as such in his diary entry for January 20, 1969, lamenting that.

in the Academy of Sciences and in the industry there is a very strong mood for the use of robots and against the *active* development of piloted flights. This aspiration is supported by the Central Committee, the [Military-Industrial Commission], and the [Strategic] Missile Forces.⁷⁴

Boris A. Stroganov, one of Serbin's deputies in the innards of the Central Committee's Defense Department, proposed that all parties should assist the Lavochkin design bureau to quickly accomplish its task of completing a sample return mission before an Apollo landing. If Soviet officials publicly touted the value of automated lunar exploration, then privately most knew that it was a poor substitute at best. The majority of participants at the meeting vocally supported piloted exploration. In fact, Afanasyev asked the attending chief designers whether a thirty-day-long Soyuz mission could be mounted in the near future to boost Soviet claims as a leading space power.

On the issue of the circumlunar L1 project, opinions were divided. Some, such as Babakin, Ryazanskiy, and Chertok, supported moving on to piloted missions regardless of the success of Apollo 8, while others, such as Mishin's deputies Kozlov and Kryukov, argued for only further automated launches. Yuriy A. Mozzhorin, the powerful Director of TsNIIMash (formerly NII-88), openly voiced a means to "save" the L1 program. Because the Soviet Union had declared that it had a space program as accomplished as the American one, simply continuing

⁷² Among those present were S. A. Afanasyev (MOM), G. N. Babakin (CSMZ Lavochkin), V. K. Bezverbiy (TSKBEM), B. Ye. Chertok (TSKBEM), G. I. Degtyarenko (TSKBEM), B. A. Dorofeyev (TSKBEM), V. P. Finogeyev (NII AP), A. G. Iosifyan (VNII EM), D. I. Kozlov (TSKBEM Kuybyshev Branch), S. S. Kryukov (TSKBEM), V. P. Mishin (TSKBEM), A. S. Mnatsakanyan (NII TP), Yu. A. Mozzhorin (TsNIIMash), S. O. Okhapkin (TSKBEM), N. A. Pilyugin (NII AP), M. S. Ryazanskiy (NII Priborostroyeniya) and B. A. Stroganov (TsK KPSS Defense Industries Department).

⁷³ Interview Peter Gorin by the author November 18, 1997.

⁷⁴ Kamanin 'I Feel Sorry for Our Guys' no. 13.

the L1 program would not do. Instead, he suggested giving the project a "scientific flavor," as if to suggest that the Soviet Union had higher goals than simply competition. It was in fact exactly such a tack that official Soviet spokespersons took in the coming months as the USSR half-heartedly continued the circumlunar project in its automated variant. Plans for piloted missions were indefinitely postponed in March 1969, while the remaining 7K-L1 spacecraft were prepared for use only in robotic mode.

As for the N1-L3 program, some, such as Chertok and Mishin's principal aide for new projects, Vitaliy K. Bezverbiy, admitted openly for the first time what was privately beyond debate for over a year: that the Soviet Union could no longer overtake the United States in a landing of humans on the Moon. There was, however, overwhelming support for reconfiguring the N1-L3 program so as to use two launch vehicles to assemble a lunar complex in Earth orbit, instead of the one planned for several years. Participants considered two separate options: one using the current variants of the N1 and one using advanced and updated versions. The first option, supported by Kryukov, Mozzhorin, Pilyugin, and Ryazanskiy, among others, was motivated primarily by the poor performance characteristics of the first four flight models of the N1, vehicle nos. 3L, 4L, 5L, and 6L; none of them were capable of lifting the ninety-five tons required for a bare-bones L3 lunar mission. Thus, two launches would ensure that all the components of the L3 complex would reach orbit. It must have been particularly demoralizing to hear Chief Designer Pilyugin state that engineers were not sure they could make the ninety-five-ton mass limit for the L3 complex, *even if* the N1 could lift such a payload into Earth orbit. His Deputy Vladlen P. Finogeyev reminded everyone that because the L3 design had been redrafted three times in the last few years, there was not even an LOK or an LK spaceship in any shape or form existing anywhere.

The second option—using updated N1s—was attractive because it would enable engineers to expand the landing crew size from one cosmonaut to two—a crucial issue that factored into the discourse on the safety of cosmonauts on the Moon. Among the variants considered at the time were the N1F-V3 and N1F-V4, with liquid hydrogen stages in the third and fourth stages, respectively. The most favored option seems to have been the use of the two N1F-V4s to launch a huge lunar complex into Earth orbit, called the L5, which would allow four to five cosmonauts to spend up to two months on the surface of the Moon. In the end, nothing was decided. It seems to have been a meeting to air the "dirty laundry," a catharsis of sorts. Perhaps the most pointed comments were from TsKBEM Deputy Chief Designer Chertok who, during his speech, very accurately observed that the Soviet space program had less resources than the U.S. program and yet was spending its money with even less rationality. It was a dead-on observation on the poverty, not only of money, but also of management, in the Soviet space program in the 1960s.⁷⁵

Major consultative meetings of the Council of Chief Designers were set for late January 1969, and in preparation, Mishin met with many leading officials through the month to discuss various aspects of the piloted lunar program. On January 24, he examined both the current N1-L3 effort as well as possible modernized variants. One of the issues at hand was the possibility of eliminating the testing of the TIK, TZK, and L1E Earth orbital test beds to reduce the amount of work. In addition, once again, there was some discussion on the complicated LK plus LK (backup lander) plus Ye-8 (rover) profile planned for the L3. He also drew up preliminary documents on inviting other organizations—namely the S. A. Lavochkin State Union Machine Building Plant—to manufacture the payload block for the proposed N1F-V3 rocket.⁷⁶ Problems with the LOK and the LK had also cropped up. Both spacecraft were still overweight, the former by five kilograms. As an example of the lengths to which the Soviets worked on "shaving

75. Gorin Interview, November 18, 1997.

76. The payload block of the N1F-V3 consisted of Blok G, Blok D, the transfer fairing, and Blok I

off" mass from the lander, engineers proposed eliminating an eighteen-kilogram visor and a sighting instrument from the LK.

The following day, January 25, Mishin met with Chief Designer Pilyugin of the Scientific-Research Institute of Automation and Instrument Building, one of Korolev's old associates from the 1940s who now presided over the development of most control and guidance systems for Soviet spacecraft. The meeting was important because, for the first time, there was serious discussion of using Mars to neutralize the success of Apollo. The two chief designers discussed a three-step Mars exploration program:

- Mars 73—a robotic vehicle to Mars for sample return (on the NI)
- Mars 75—a piloted satellite of Mars (on the NIF-V3)
- Mars 77—a piloted landing on Mars using an NI with nuclear rocket engines

In the meantime, Pilyugin suggested continuing the current NI-L3 program, but in a two-launch scheme, both with and without the Ye-8 rovers. He suggested that to reduce extraneous work, Soviet designers should focus on creating a single modernized version of the NI, the NIF-V3. Perhaps prompted by the discussion with Pilyugin, Mishin brought up the issue of Mars at an internal meeting on January 26, at which he considered the possibility of inviting the Ministry of Medium Machine Building to develop nuclear power sources for Martian spacecraft.

These discussions culminated in widely attended and important meetings of the Council of Chief Designers on January 26 and 27, 1969. Apart from the usual chief designers and their deputies, a number of important scientists from the Academy of Sciences and representatives from the military were also present.⁷⁷ Academician Keldysh set the meeting off with the admonition that there was no hope of carrying out the NI-L3 program as it then stood. Instead, he believed that designers should focus on improving the capabilities of the NI with liquid hydrogen upper stages and carrying out the three-step Mars exploration program, with missions in 1973, 1975, and 1977-80. Although most at the meeting agreed that Mars should be the next goal for the Soviet space program, there was little support to completely abandon the Moon. For the Mars expedition, most of the attendees supported the creation of the updated NI booster, the NIF-V3, which would have a new third stage equipped with Chief Designer Lyulka's 11D54 liquid hydrogen-liquid oxygen engine. One attendee, Viktor I. Shcheulov, an officer in the Strategic Missile Forces, cautioned that liquid hydrogen stages would not be ready for use until 1971 at the earliest.

Shcheulov made one of the more prophetic statements at the meeting. He believed that the creation of Earth-orbital space stations would smooth the effect of recent U.S. successes in space. TskBEM had, for many years, explored various conceptions of space stations, one of them being a huge complex in orbit called the Multirole Space Base-Station (better known simply as the "MKBS"), which would allow for the replacement of crews on board, thus establishing a permanent piloted presence in space. The space station option, while not as attractive as Mars, was slowly beginning to emerge at the time as a possible alternative long-range goal for the Soviet space program. In January 1969, with the recent success of Apollo 8 in mind, there was, however, more of an interest in the Moon and Mars, and this clearly influenced the formation of a post-1968 space policy for the Soviets. At a meeting on January 29 for his senior staff at the design bureau, Mishin brought up the issue of the Moon, Mars, and Earth-orbital stations.⁷⁸ Most of the designers agreed on a two-prong long-range program:

⁷⁷ Among those present were K. D. Bushuyev (TskBEM), A. C. Iosifyan (VNII EM), M. V. Keldysh (AN SSSR), M. S. Khitrik (NII AP), G. P. Melnikov (NII 4), V. P. Mishin (TskBEM), A. S. Mnatsakanyan (NII TP), Yu. A. Mozzhorin (TsNII Mash), G. N. Pashkov (VPK), M. S. Ryazanskiy (NII Priborostroyeniya), C. I. Severin (KB Zvezda), V. I. Shcheulov (TsUKOS), and G. I. Voronin (KB Nauka).

⁷⁸ Among those present were V. K. Bezverbiy, B. Ye. Chertok, K. P. Feoktistov, V. P. Iegostayev, S. O. Okhapkin, V. N. Pravetskiy, I. I. Raykov, and Ye. F. Ryazanov. All were from TskBEM.

- The development of the MKBS in Earth orbit, whose design would be based on old designs for the Heavy Interplanetary Ship dating from the Korolev days
- The use of the MKBS to mount a Mars expedition

Much of the discussion was focused on the development of closed-cycle life support systems to ensure survival over a period of two to three years in space, as well as nuclear-electric power sources for such advanced missions.⁷⁹ The MKBS would also be used for defense goals.

The general consensus from the meetings was that the Soviet Union should continue work intensively on the NI-L3 program, now as part of a dual-launch Earth-orbit rendezvous lunar-orbit rendezvous profile, but at the same time begin planning for the coup *de grace*—a progressively sophisticated Mars landing program over the next decade, which promised to bring the prestige of the Soviet space program out of its current doldrums. The Mars program would use components of the large Earth-orbital station, the MKBS, which would also be dedicated to defense purposes. The somewhat diffuse and perhaps hasty response to the success of Apollo 8 was not confined to the restricted corridors of the Soviet space establishment. Academician Keldysh, in a statement to Moscow Radio on January 24, hinted at the uncertain prospects for the future of the Soviet space program. Putting a bright face on the recent Soyuz 4/5 success, he spoke clearly about new directions: the establishment of permanent orbital stations and the accomplishment of interplanetary flights. Speaking of the Zond spacecraft and its capability to carry cosmonauts around the Moon, he added that such a flight should not be expected in the next two or three weeks. In closing, he said simply that piloted lunar operations "depends somewhat on our further considerations as to what we shall do with automatic apparatus and with manned ones."⁸⁰

The NI in Flight

It is ironic that at precisely the time when the Soviets were having second thoughts about the Moon, a number of their lunar projects approached the flight testing stage, making 1969 one of the busiest years for lunar-related space launches in the history of the Soviet space program. The armada was inaugurated by a launch during January that punctuated the intensive high-level discussions on the Moon program. Prompted by TsNIIMash Director Mozhgorin's suggestion to continue robotic LI launches with a "scientific" tenor, it seems that Minister Afanasyev had sanctioned further launches in the beleaguered program, beginning with one in January 1969. Ironically, a number of the LI cosmonauts, including Bykovskiy, were on hand at Tyura-Tam to view the launch, no doubt fully aware that their chances of ever flying around the Moon had abruptly dropped dramatically.

The 7K-L1 vehicle, spacecraft no. 13, was the same article that was to have been launched in early December on a robotic circumnavigation of the Moon, but was stood down because of the catastrophic crash of Zond 6.⁸¹ The Proton booster lifted off successfully at 04:14 hours, 36 seconds Moscow Time on January 20, 1969. After first-stage cutoff, the second stage began firing, but at T+501 seconds, the booster began to fall. After several minutes, controllers reported to State Commission Chairman Tyulin at the command center at site 2 that search-and-rescue services had detected the LI spacecraft, saved by the emergency rescue system, southeast of Irkutsk near the border with Mongolia. It took about four hours for analysts to produce a preliminary accident

⁷⁹ The Soyuz Moscow Machine Building Plant (formerly OKB 300) headed by Chief Designer S. K. Tumanskiy had developed nuclear power sources capable of producing ten kilowatts by 1969. He expected to create more powerful units—at fifty kilowatts by 1970 and up to 2,500 kilowatts by 1975.

⁸⁰ *Soviet Space Programs 1966-70*, p. 372.

⁸¹ Interestingly, in early January 1969 a cable network on spacecraft no. 13 had been severed. Engineers opted to replace part of the network with parts from the already flown spacecraft no. 7, which had been launched in April 1968 and recovered after a launch failure.

report. One of the four engines of the second stage had shut down abruptly, twenty-five seconds prior to the planned cutoff point. At this point, the third stage could have easily fired to compensate and inserted the payload into orbit, but a diagnostics computer on the booster, as soon as it had detected the engine failure, aborted the mission and fired the emergency rescue system for the L1 spacecraft.⁸² Thus was lost 100 million rubles and another chance to fly to the Moon." It was the fourth launch failure in the circumlunar program out of only nine launch attempts, illustrating that one of the weakest links in the project was the UR-500K Proton booster, designed and built by a branch of Chelomey's design bureau.

With that inauspicious beginning, engineers moved on to more ambitious prospects. In February 1969, both Babakin's first Ye-8 lunar rover and Mishin's first N1 rocket were ready for liftoff. In fact, in what was certainly not a coincidence, their launches were timed a day apart. The specially made 7K-LIS lunar spacecraft would arrive in lunar orbit and attempt to photograph the Ye-8 rover on the surface. Since the original May 1968 launch date, engineers had spent months mired in a frustrating delay. Although the first flight-rated N1 vehicle, booster no. 3L, was completely ready for launch and the basic construction of the first launch pad had been finished by the end of 1967, problems with many pad-booster interface systems forced launch date postponements for weeks and then months.⁸⁴ On September 18, 1968, Afanasyev had presided over a meeting of the State Commission for the N1 at Tyura-Tam at site 112 near the N1 pads. Approximately 100 chief designers, deputies, Strategic Missile Forces and Air Force officers, and government officials were present during the five-hour meeting. The participants noted that three different deadlines stipulated by Central Committee decrees had not been met. At the time, the IMI mock-up was on the completed pad at site 110P with a functional payload undergoing fueling tests to allow service teams to train and gain experience for actual launches. Kamanin, who attended the meeting, recalled, "There have been lots of drawbacks, improper quality of work and plain bungling—in particular there was an accident with a bulldozer cutting the main power supply of the launch pad."⁸⁵ At the meeting, Afanasyev scheduled the first launch for late November 1968 and the second one for February 1969.

82 Kamanin 'I Feel Sorry for Our Guys' no. 13

83 Although Russian sources suggest that this launch was an attempt at a circumlunar flight the launch date for the mission would seem to indicate that it may have been a deep space mission much like Zond 4. Richard Flagg's analysis of L1 launch windows during 1968-70 suggests that Zond circumlunar launches were only attempted when trajectories could be flown that were close to coplanar with the Moon's orbit to minimize the effects of the Moon's gravity. If a 7K L1 craft approached the Moon from a transfer orbit with a large angle relative to the Moon's orbital plane then the force of lunar gravity would have changed the plane of the orbit, deflecting the craft from the required return trajectory. In such a situation the 7K L1 spacecraft's main engine would not have been powerful enough to effect mid course corrections to return the vehicle on an Earth bound trajectory. An additional scientific requirement was for the far side of the Moon to be illuminated during the mission to carry out surface photography. In examining the launch windows of the 7K L1 Flagg observed that there were no circumlunar launch windows that satisfied these criteria from January 1969 to July 1969. However lunar age, declination, phase, and opening angle were close to permitting a 7K L1 launch during January 7-9, 1969 although those parameters were definitely outside those as defined by the successful Zond flights. See *Soviet Space Programs 1981-87*, Space Science Applications, Military Space Programs Administration, Resource Burden, and Master Log of *Spaceflights*, prepared for the Committee on Commerce, Science, and Transportation, U.S. Senate, 101st Congress, 1st sess. (Washington, DC: U.S. Government Printing Office, April 1989), pp. 384-386. Curiously on January 3-4, 1969 news of a Soviet launch failure that was apparently detected by NORAD was 'leaked' to the Western press. The failure was said to have occurred because of a second stage malfunction. See Gatland, *Robot Explorers*, p. 144.

84 Boris Arkadyevich Dorofeyev "History of the Development of the N1 L3 Moon Program" presented at the 10th International Symposium on the History of Astronautics and Aeronautics, Moscow State University, Moscow, Russia, June 20-27, 1995.

85 Kamanin 'A Coal Worth Working for' There was a complete fueling exercise involving the N1 stack in October 1968 that lasted ten days. See Maj Gen Valery Aleksandrovich Menshikov 'The Toilers of the Cosmodrome: The Test Personnel of Baykonur' (English title) *Aviatsiya i kosmonautika* no. 1 (January 1993), 39-41. The flight version of the N1 booster 3L was moved to the pad in November 1968 but it was replaced briefly by the IMI again.

Engineers were unable to remedy the interface problems until December 1968, forcing another two- to three-month delay. A few days before the Soyuz 4/5 missions, on January 9, 1969, amid discussions about a post-Apollo 8 strategy, Afanasyev convened another meeting of the NI State Commission. It was unusual for a minister to head a State Commission, and Afanasyev's appointment to the position underlines the importance with which space program head Ustinov viewed the NI rocket program. After hearing a number of reports, Afanasyev set the launch date for the first NI as February 18, 1969, within the launch window for a lunar-orbital flight. The proceedings were interrupted by an alarming report from Baykonur Cosmodrome Commander Maj. General Aleksandr A. Kurushin, who refused to agree to a launch of the rocket because of many "deficiencies" in both the ground equipment and the rocket itself. After pressure from most of the members of the State Commission, including Afanasyev and Mishin, as well as Party Central Committee representative Stroganov, Kurushin backed down and promised to have these "deficiencies" removed by the slated launch date." Needless to say, Kurushin's initial outburst did little to instill confidence in a success.

The final prelaunch cycle for the first NI launch began in mid-January 1969. The twenty-eight-day program involved 2,300 people from dozens of different organizations and fifty tank wagons for liquid oxygen fueling of the rocket." The majority of the site workers were Army conscripts, who, as one participant recalls, had come from backgrounds unrelated to the space program:

The test officers at the time were principally 35-40 years old, without higher education and came from all over. Tankers and artillerymen, pilots and sailors, combat engineers and chemists—in short, it would be easier to list who was not there—were encountered among them.⁸⁶

The men completed their job on time. On February 3, booster no. 3L was slowly moved from the assembly-testing building to the launch pad on a special crawler-transporter. At the pad itself, the giant booster was lifted to a vertical position and held up by a sixteen-meter support ring with forty-eight explosive bolts at the base of the first stage. The mass of the booster and its L3S payload was exactly 2,772,103 kilograms. By the time of its first launch, models off the first-stage engines for the rocket had accumulated over 100,000 seconds of test operating time on the ground.⁸⁹

86 Kamanin 'I Feel Sorry for Our Guys' no 13

87 J Villain 'A Brief History of Baykonur' presented at the 45th Congress of the International Astronautical Federation IAA 94 IAA 2 I 614 Jerusalem Israel October 9-14 1994

88 Menshikov 'The Toilers of the Cosmodrome' p 40

89 The L3S designation was confusingly applied to the payload for the first two NIs which consisted of Blok G Blok D and the 7K LIS lunar orbiter



The first NI rocket being brought to the pad for launch in February 1969 (files of Asif Siddiqi)

The assault on the Moon in February 1969 began with the launch of the first Ye-8 lunar rover. A Proton booster lifted off successfully at 0948 hours Moscow Time on February 19 with its payload. Ye-8 vehicle no. 201 and its translunar-injection Blok D stage. As Babakin's engineers watched the rising rocket, just over fifty-one seconds after launch, the payload abruptly fell apart, and the booster eventually exploded. The debris from the accident, including portions of the lunar rover, fell fifteen kilometers from the launch site. A later investigation found that the source of the problem had been a new payload fairing designed and built specifically for the rover payload. Aerodynamic vibrations during passage through maximum dynamic pressure tore the shroud off at its weakest tension points. The debris tore into the lower stages of the rocket, resulting in a massive explosion at Tt54 seconds. Despite an intensive search of the debris area, engineers were unable to find the Polonium-210 radioactive isotope in the rover payload designed for heating the spacecraft on the Moon. Unconfirmed rumor has it that soldiers at Tyura-Tam discovered the isotope package and used it to heat their barracks during the bitter winter of 1968-69.⁹⁰ With two failures out of two Proton launch attempts in the year, space officials turned their attention to the long-awaited first launch of the NI rocket.

The launch was originally set for February 20, but it was delayed to the afternoon of February 21 because of poor weather conditions at the launch site." Boris A. Dorofeyev, Mishin's deputy for testing the NI, directed all the launch preparations: he would perform the same on-site technical direction carried out by the late Leonid A. Voskresenskiy back in the 1940s and 1950s. Before the launch, a senior engineer ceremoniously broke a bottle of champagne on the main body of the NI's launch transporter." It was a clear and cold day at the Baykonur Cosmodrome, and prelaunch operations proceeded without delays. Almost four years late, the most powerful rocket ever built by humans fired its engines precisely on time at 1218 hours, 7 seconds Moscow Time on February 21, 1969. The thirty first-stage engines generated a total of approximately 4,590 tons of thrust, and within thirteen seconds, the NI soared off the pad and headed out into the skies with its L3S payload. Deputy Chief Designer Chertok vividly described the launch of this monster:



This photograph was taken moments before the launch of [the first NI, booster no. 3L, in February 1969. (copyright Quest)

90. Konstantin Lantratov, "Anniversaries: 25 Years From Lunokhod-1" (English title), *Nauosti kosmonavtiki* 24 (November 19-December 2, 1995): 70-79; O. A. Sokolov, "The Race to the Moon: A Look from Baykonur," presented at the 45th Congress of the International Astronautical Federation, IAA-94-2.1.610; N. G. Babakin, A. N. Banketov, and V. N. Smorkalov, *Ch N Babakin rhizn i deyatelnost* (Moscow: Adamant, 1996), p. 57; Kamanin, "I Feel Sorry for Our Guys," no. 13; I. Lisov, "Launch and Flight of the 'Mars-96' Station" (English title), *Novosti kosmonavtiki* 22-23 (October 21-November 17, 1996): 48.

91. Igor Afanasyev, "NI: Absolutely Secret" (English title), *Kryla rodiny* no. 9 (September 1993), 13-16.

92. Vad. Pikul, "The History of Technology: How We Conceded the Moon: A Look by One of the Participants of the NI Drama at the Reasons Behind It" (English title), *Izobretatel i ratsionalizator* no. 8 (August 1990), 20-21.

Even if you have attended our Soyuz launches dozens of times, you can't help being excited. But the image of an N1 launch is quite incomparable. All the surrounding area shakes, there is a storm of fire, and a person would have to be insensitive and immoral to be able to remain calm at such moments. You really want to help the rocket: "Go on, go up, take off."⁹³

And go it did, despite the fact that between three and ten seconds of ignition, the Engine Operation Control (KORD) system erroneously shut down two first-stage engines. All seemed well until T+70 seconds, when the KORD system abruptly shut down *all* the engines of the first stage, well before planned engine cutoff. This let the behemoth fly upward to an altitude of twenty-seven kilometers and then gradually descend on a trajectory that led to impact about fifty kilometers from the launch site. The emergency rescue system was activated after engine cutoff, and the descent apparatus of the 7K-L1S spacecraft landed without incident thirty-two to thirty-five kilometers from the pad area.⁹⁴

Because it was the first launch attempt of a booster whose first stage had not been tested on the ground, engineers were not unduly discouraged by the failure, although the timing of the loss, as NASA was gearing to land on the Moon, perhaps lent a disheartening tenor to the recovery operation. Military-Industrial Commission Chairman Sernimov was apparently satisfied with the performance of the rocket, and Mishin himself reassured his engineers that "this is normal for a first launch."⁹⁵ Official historians of Mishin's design bureau were more specific:

Despite the accident, this launch confirmed the correctness of the selected dynamic scheme, the dynamics of the launch, the control processes of the

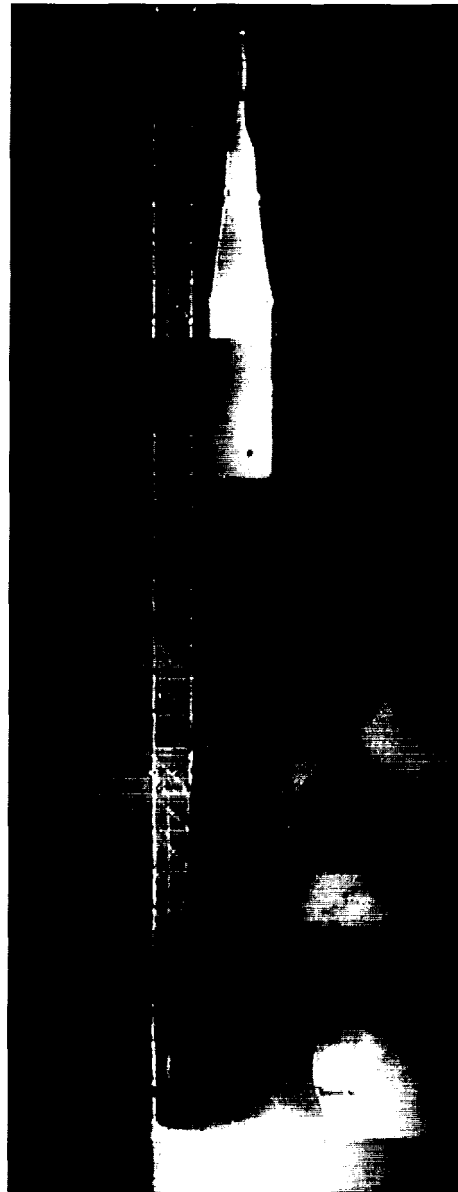

These movie stills pieced together show the launch of the first N1 Moon rocket in February 1969 (copyright VideoCosmos Co., via Don Pealer/Quest)

93. Sergey Leskov. "How We Didn't Get to the Moon" (English title). *Izvestiya*, August 18, 1989, p. 3

94. Marinin and Sharnsutdinov. "Soviet Programs for Lunar Flights". Kamanin. "I Feel Sorry for Our Guys," no. 13

95. M. Rebrov. "But Things Were Like That—Top Secret: The Painful Fortune of the N1 Project" (English title). *Krasnaya Zvezda*, January 13, 1990, p. 4; Pikul, "The History of Technology."

[booster] with the aid of coordinated engine thrusts, and allowed the receipt of experimental data on the loads on the [booster] and its precision, the influence of acoustical loads on the rocket and the launch system and [on its] operational characteristics in realistic conditions."

It was clear after the launch that during the forty-first second of flight, one of the thirty engines of the first stage had failed and ignited others around it. As designers gathered after the launch, Mishin seemed to believe that the failure was probably caused by a malfunction in the turbogenerators, which provided electric current for the booster. First Deputy Chief Designer of the All-Union Scientific-Research Institute for Electro-Mechanics Nikolay N. Sheremetyevskiy recalls that Mishin squarely laid the blame on him before leaving the launch site. Later analysis of telemetry proved that Mishin was wrong. In fact, when the turbogenerators were recovered from the debris, both units were still in operating condition."

Senior NI engineers were able to report on the results of a preliminary investigation on the causes of the failure by March 11, 1969. The critical KORD system had clearly failed to meet the required standards for flight operation. As designers reported, the KORD system had not passed acoustical testing: an analysis of the reliability of the system had shown that KORD could not react to all possible conditions. As reconstructed from telemetry and an analysis of debris, 0.37 seconds prior to engine ignition, the KORD system shut down engine no. 12, and then by its logic, the opposite engine no. 24, although both were functioning without problem. Thus, by the time the rocket lifted off from the pad, twenty-eight of the thirty engines were firing: the remaining engines compensated fully for the absence of the two shutdown units and kept the booster aimed perfectly on a nominal trajectory. At T+5.5 seconds, excessive vibrations in the gas generator of engine no. 12 caused a line connected to a gas-pressure sending unit behind the turbine to rupture. The engine was beset by a second problem at T+23.3 seconds when, after the throttling down of thrust to reduce loads during maximum dynamic pressure, a two-millimeter-diameter pipe for measuring the fuel pressure in front of the engine's gas generator punctured. Consequently, "acid" gas with a temperature of 340 degrees Centigrade began mixing with the propellant, forming an extremely flammable solution. Eventually, at T+54.5 seconds, a fire broke out in the tail section of the first stage. Ground telemetry clearly showed a sharp rise in temperature at that point in engine nos. 3, 21, 22, 23, and 24. At T+68.67 seconds, the fire burned through the cable insulation, thus causing a short circuit in the 1,000-hertz direct-current and alternate-current circuits of the KORD system, which issued a command to shut down all the remaining twenty-eight engines of the first stage.⁹⁸

96. Semenov, ed. *Raketno-Kosmicheskaya Korporatsiya*, p. 257.

97. Yu. A. Mozhorin, et al., eds., *Dorogi v kosmos I* (Moscow: MAI, 1992), p. 195.

98. Afanasyev, "NI Absolutely Secret". Jeffrey M. Lenorovitz. "Trud Offering Liquid-Fueled Engines From NI Moon Rocket Program." *Aviation Week & Space Technology*, March 30, 1992, pp. 21-22. An excerpt from the official accident investigation of the 3L launch is included in R. Dolgopyatov, B. Dorofeyev, and S. Kryukov, "At the Readers' Request: The NI Project" (English title), *Aviatsiya i kosmonautika* no. 9 (September 1992): 34-37. There are conflicting versions of the accident. One commonly quoted scenario is that at T+66 seconds, "the elevated vibrations caused by acoustical loads ruptured a line that feeds oxidizer to the gas generator of one of the (engines); the leaking liquid oxygen started a fire in the aft section." See Afanasyev, "Unknown Spacecraft." The "elevated vibrations" arose because at T+65-66 seconds, the first-stage engines "throttled back to full power, but much stronger than expected causing strong vibration[s]. The oxidiser pipeline of one engine broke spilling liquid oxygen. The KORD control system was unable to shut the engine down quick enough and a fire broke out." See V. A. Lebedev, "The NI-L3 Programme." *Spaceflight 34* (September 1992), 288-90; I. A. Marinin and S. Kh. Shamsutdinov, "Soviet Programs for Piloted Flight to the Moon" (English title), *Zemlya i vselennaya* no. 5 (September-October 1993), 77-85. The official history of the Korolev design bureau states that there was a failure in engine no. 2 because of high-frequency oscillations in its gas generator. As a result, a pressure carbine punctured, allowing the propellants to cause a fire in the tail end of the rocket. The fire disrupted the operation of the on-board cable network of the KORD system, which issued a command at T+68.7 seconds to shut off all the engines. See Semenov, ed., *Raketno-Kosmicheskaya Korporatsiya*, p. 257.

Overall, it was clear that the main problem for the booster was the lack of integrated ground testing for the first stage. In addition, there had been inadequate testing of the first-stage engines because of the absence of vibration stands. The space industry's leading research and development institution, TsNIIMash, recommended the introduction of a burn-monitoring system on the engines and stages prior to assembly as part of a flight model, but these recommendations were apparently rejected because of the lack of time and resources—a familiar reasoning offered throughout the 1960s." Mishin and Kuznetsov introduced some cosmetic changes to the following flight models of the NI, including the deletion of the pressure sending unit and its pipe behind the turbine. The KORD system's main network was moved from the aft compartment into the intertank section. Additional improvements included adding new ventilation openings below the fuel pipeline covers to allow external air into the inside compartment.¹⁰⁰ Booster no. 4L was moved out of the queue of flights to allow for the cosmetic modifications as well as more substantive ones to improve lifting capacity. The next NI launch would instead use booster no. 5L.

To the Finish Line

In March and May 1969, NASA performed two highly successful Apollo missions. Apollo 9 and Apollo 10, respectively, bringing the United States ever so closer to landing astronauts on the surface of the Moon. On Apollo 9, astronauts had thoroughly tested the Lunar Module in complex rendezvous and docking operations in Earth orbit. Such activities were repeated in lunar orbit on Apollo 10. In the Soviet canon, such missions would have been out of the question in 1969 because none of its lunar spacecraft were flightworthy: Chief Designer Yangel's engineers static-fired the important Blok Ye engine of the Soviet lunar lander for the first time only in February 1969." Through the dampening enthusiasm, an increasingly small group of cosmonauts continued to train for lunar landings at both the Yu. A. Gagarin Cosmonaut Training Center or at the M. M. Gromov Flight-Research Institute, both located near Moscow. On March 28, 1969, veteran cosmonaut Bykovskiy was appointed the chief of the lunar department of the cosmonaut detachment."¹⁰¹ By June 18, this department included only eight men out of the original group of approximately twenty-five from early 1968 who had trained for lunar landing missions. The eight included three Air Force officers training to land on the Moon—Valeriy F. Bykovskiy, Yevgeniy V. Khrunov, and Aleksey A. Leonov—and five others training to remain in lunar orbit during surface operations—Oleg G. Makarov, Viktor I. Patsayev, Nikolay N. Rukavishnikov, Anatoliy F. Voronov, and Aleksey S. Yeliseyev.¹⁰³

The training was most challenging for the three preparing to land on the Moon. A dynamic simulator, built on the basis of an Mi-9 helicopter (itself modified from the Mi-8), allowed the cosmonauts to train for the actual landing phases. Having finished helicopter school, the trainees flew the helicopters to simulate worst-case scenarios for landing. Leonov recalls: "I

99 Rebrov "But Things Were Like That " The article does not explicitly mention TsNIIMash but rather "the head institute " which was usually a euphemism for TsNIIMash

100 Afanasyev "NI Absolutely Secret" Alexander Yasinsky "The NI Rocket Programme " *Spaceflight* 35 (July 1993) 228-29 Marinin and Shamsutdinov "Soviet Programs for Piloted Flight to the Moon "

101 V Pappo Korystin V Platonov and V Pashchenko *Dneprovskiy raketno kosmicheskii tsentr* (Dnepropetrovsk PO YuMZ/KBYu 1994) p 77 The tests were conducted at the giant testing facilities at Zagorsk belonging to NII KhimMash

102 Voevodin *VSA053* The cosmonaut detachment as a whole was split up into different departments including orbital space stations (headed by G S Shonin) spaceships (P R Popovich) air space systems (G S Titov) and candidate cosmonauts (P I Belyayev)

103 Kamanin "I Feel Sorry for Our Guys " no 13

made nine very difficult landings in that helicopter with the engines cut. Normally pilots don't do such landings because they usually end in a catastrophe, but we did it. We cosmonauts and pilots perfected the art."¹⁰⁴ They also took training courses at the M. M. Gromov Flight-Research Institute to master the ability to choose a landing site in the shortest time with minimal propellant reserves, while evaluating vertical velocity, to enable a survivable landing on the ground. After TsKBEM engineers had completed their preliminary landing simulations of the LK at the testing station at Zagorsk, the cosmonauts were invited to participate in landing trials on fake lunar landscape in specially built landing simulators at the Kiev Institute of Civil Aviation Engineers.

The training eventually had cosmonauts wearing the Krechet-94 lunar suit in simulated lunar gravity. One of the fears among engineers was the possibility of the cosmonaut falling over on the surface and being unable to get up in the low gravity in the cumbersome lunar suit. To circumvent this problem, engineers came up with an ingenious solution consisting of a large

hula-hoop-type ring that would be attached to the waist of the spacesuit before disembarking on the lunar surface. The larger part of the hoop was at the back side so as not to interfere with arm movements. The cosmonauts participated in sessions in special aircraft that simulated one-sixth gravity during which they "fell down" on their backs and simply rolled over and lifted themselves up. Another concern was depressurization after launch from the Moon. In a grueling exercise carried out in 1968, an Air Force captain dressed in a cumbersome pressure suit spent twelve torturous hours in an LOK cabin placed in a pressure chamber.¹⁰⁵

The cosmonauts may have been engaged in intensive training to land on the Moon, but if the barometer of public statements from Soviet officials was any indication, the USSR was very confused about its next destination. Academician Blagonravov, the venerated doyen of Soviet space spokespersons, intimated in a statement reported by TASS on March 14, 1969, that there was still much work to be done before a Soviet lunar landing. Yet less than a month later on April 9, recently flown cosmonaut Shatalov told the Hungarian press that the Soviet Union would need "six, seven, and perhaps more months" of preparations before a landing on the Moon. He added with confidence that "who makes the better preparations will get to the Moon first, and it is our wish to do so." L3 trainee Leonov was also unequivocal in his belief in the power of Soviet science:



Cosmonaut Aleksey Leonov appears here in training for lunar landing approaches using a specially equipped helicopter. This photo dates from around 1969 (NASA photo)

104. "The Russian Right Stuff: The Dark Side of the Moon," NOVA television show. #1808. WCBH-TV. Boston, February 27, 1991. The M. M. Gromov Flight-Research Institute had put in a request for an Mi-4 helicopter to train for lunar landings as early as March 8, 1965. See N. P. Kamanin, *Skytry kosmos kniga vtoraya. 1964-1966gg* (Moscow: Infotekst IF, 1997), p. 210.

105. Lardier, *L'Astronautique Soviétique*, p. 176. Afanasyev, "Unknown Spacecraft": Kuznetsov, "The Flight That Did Not Occur": S. Leskov, *Kak my ne sletali na lunu* (Moscow: Panorama, 1991), p. 12; V. M. Filin, *Vospominaniya o lunnom korablye* (Moscow: Kultura, 1992), pp. 60-61. The Air Force captain was Zhon Gridunov.

106. *Soviet Space Programs, 1966-70*, p. 372.

The Soviet Union is also making preparations for a manned flight to the Moon, like the Apollo program of the United States. The Soviet Union will be able to send men to the Moon this year or in 1970. We are confident that pieces of rocks picked from the surface of the Moon by Soviet cosmonauts will be put on display in the Soviet pavilion during the Japan World Exposition in Osaka in 1970.¹⁰⁷

Leonov's somewhat misplaced confidence was astonishing because it came quite possibly at the utmost nadir of the Soviet space program in the 1960s. Removed from actual decision making within the Soviet space program, the cosmonauts were in general prone to more dramatic and often outlandish statements than older officials at conferences. However, even the cosmonauts must have surely known that there would be no Soviet cosmonaut on the Moon in 1969 or indeed in 1970.

The mainstream of Soviet public pronouncements was, however, turning to Earth-orbital space stations as the "mother lode" of future operations. Following the intensive high-level discussions in January 1969, the Soviets persistently began to emphasize two major directions: automated lunar exploration and permanent space stations in Earth orbit à la Tsiolkovskiy. Statements from academicians, anonymous chief designers, cosmonauts, and official radio commentators proliferated into the new Soviet propaganda offensive even before an American had set foot on the Moon. A third option, piloted Martian missions, would be emphasized in the future as the technology became available. These statements were the first in a long series in 1969 to bombard the Western media with the idea that the Soviet space program was neither politically motivated (which is why the "race to the Moon" was unimportant) nor narrow (which was why Earth-orbital stations were being planned). These pronouncements were hard to counter because real Soviet intentions had always been cloaked in mystery. But the Soviets themselves were fully aware of this obfuscation of truth. Air Force Aide Kamanin wrote in his diary during the Apollo 10 mission of the "unrestrained lying" by Soviet officials on the issue of Soviet intentions with respect to the Moon. He added bitterly, "We have come to the end to drink the bitter chalice of our failure and be witnesses to the distinguished triumph of the U.S.A. in the conquest of the Moon."¹⁰⁸

For Soviet government and Communist Party leaders, the impending humiliation was a hard pill to swallow. In early April 1969, Communist Party General Secretary Brezhnev invited Vasilii P. Mishin to report on the work of the Soviet piloted space program during his three-and-a-half-year tenure as chief designer of the leading Soviet space enterprise. Mishin painstakingly explained the root reasons for the poor showing of the Soviet program in comparison to Apollo—all symptoms evident to any high-level space official in the Soviet Union. There was the institutional disarray in the organization of the space industry. Although there were many multi-profile design bureaus, there were severe shortages of subcontractor institutions. The production plants were badly organized with poor quality control, and each plant handled too many different production lines and was not specialized enough. Most tellingly perhaps, Mishin also touched on ideological reasons; he emoted on the lack of material incentives among workers in fulfilling plant orders of experimental models of articles.

Among the four major points discussed at the meeting was an agreement to limit the L1 circumlunar project to only further automated flights, thus unequivocally terminating any hopes of cosmonauts flying around the Moon in the near future. As far as the NI-L3 program,

107 *Ibid* p 374

108 For several statements from the period, see *ibid* pp 373-75

109 Kamanin "I Feel Sorry for Our Guys" no 13

110 Gorin interview November 18 1997

Mishin could only report that a piloted landing would be preceded by a complete robotic mission, including landing and takeoff from the Moon. Future NI missions would include the docking of spaceships in Earth orbit using liquid hydrogen stages, such as Blok S, before embarking on the voyage to the Moon. Repeating a mantra that had been uttered dozens of times by both Korolev and Mishin, the latter asked for more funding to pursue liquid hydrogen research, which, despite the best efforts of many, had enjoyed only lukewarm support from the government. Mishin's two final proposals to Brezhnev involved the creation of new generations of space weapons for ballistic missile defense using the NI as a launch vehicle, and advanced flights to the Moon, Mars, Venus, and the outer planets. All of these were in the future. As far as the race to the Moon was concerned, there would be little to show from the Soviet side in 1969.

One of the more common stories proliferating in the Western media during the summer of 1969 was that the Soviets would do something spectacular before the first Apollo landing mission, Apollo 11. After the unqualified success of Apollo 10 in May 1969, NASA was looking at a lunar landing flight in July, with the ideal launch date being July 16. The question was: Could the Soviets do something to preempt the climax of the greatest American adventure of the 1960s? Nothing that the Soviets had accomplished in 1968 or 1969 had indicated that they had even a modicum of capability to attempt a full-scale lunar landing. Evidence now suggests that in June 1969, Chief Designer Mishin's most optimistic timetable for a first Soviet lunar landing was "by the end of 1970."¹¹¹ Wernher von Braun claimed in early June that it was still possible for the USSR to reach the Moon before the United States if the Apollo 11 mission was delayed, and he strongly believed that the Soviets would undertake piloted lunar flight in the "latter part of 1969" using a giant booster." The CIA clearly had less confidence in Soviet capabilities than von Braun. In a top-secret "National Intelligence Estimate" issued a month before the launch of Apollo 11, the CIA predicted that "we estimate that a [Soviet]manned lunar landing is not likely to occur before 1972 although late 1971 cannot be ruled out."¹¹² But von Braun also referred to the most widely discussed scenario: that in the few remaining weeks leading up to the launch of Apollo 11, a robotic spacecraft would scoop up some soil and bring it back to Earth.

Prompted by Apollo 8, the Soviet Communist Party and government had decreed in January 1969 to accelerate their robotic lunar exploration program. Chief Designer Babakin's engineers had done an outstanding job of producing at least five flight models of the Ye-8-5 sample return spacecraft by the summer of 1969 in sufficient time to beat Apollo 11. Apart from the fact that the Ye-8 class series of heavy lunar probes had not been tested in space even once, the engineers had to address another possible problematic issue: the poor performance of the UR-500K Proton booster. By the end of April 1969, four consecutive launches of the rocket had failed to deposit their payloads into Earth orbit, let alone into deep space.¹¹⁴ Of the total thirteen launches of the three-stage UR-500K variant (most with a fourth stage), seven had been unequivocal failures. In this context, the State Commission for the LI circumlunar program met on May 29, 1969, to address "the Proton factor." While none of the failures pointed to errors in design, they did not exonerate quality control procedures during manufacturing. Designers Chelomey, Glushko, and Konopatov promised State Commission Chairman Tyulin that the next booster would not fail, but confidence was at a high premium at that point.¹¹⁵ Perfect operation of the Proton booster

111. Kamanin, "I Feel Sorry for Our Guys," no. 13. Kamanin mentions this in his diary entry for June 19, 1969.

112. NASA Science and Technology Division, Astronautics and Aeronautics. 1969. *Chronology of Science, Technology, and Policy* (Washington, DC: NASA SP-4014, 1970), p. 170.

113. U. S. Central Intelligence Agency. "National Intelligence Estimate 11-1-69 The Soviet Space Program." Washington, DC, June 19, 1969, p. 20, as declassified in 1997 by the CIA Historical Review Program.

114. Of the four launches, one carried a 7K-L1 (in January), one carried a Ye-8 lunar rover (in February), and two carried M-69 Mars probes (in March and April).

115. Kamanin, "I Feel Sorry for Our Guys," no. 13.

was particularly critical at the time, not because of its use in the now-dying piloted circumlunar program, but because the Proton was to launch the Ye-8-5 lunar scooper to the Moon.

The confluence of activity in both the Soviet and U.S. space programs during the summer of 1969 was unprecedented. Babakin's lunar scooper had two chances to fly to the Moon, in the June and July lunar launch windows. At the same time, Mishin was almost ready to bring the second flight model of the N1 rocket to the launch pad. If the attempt was successful, the rocket would send the 7K-L1S spacecraft on an ambitious fully automated lunar-orbital flight, followed by the vessel's return to Earth. NASA would, of course, launch perhaps the most important mission in the history of American efforts to explore space. The race was now in its final lap.

Ye-8-5 spacecraft no. 402 was launched from Tyura-Tam on June 14, 1969, to reclaim some glory for the Soviet space program. If all went well, a sample of lunar soil would be back on Soviet territory in a little more than eleven days. Unfortunately, the spate of Proton failures did not abate. After the third stage had completed firing, the fourth Blok D stage was to fire to insert the payload into Earth orbit. Because of a disruption of an on-board circuit, the control system failed, preventing the Blok D engine from firing. The payload instead traced an arc that deposited it into the Pacific Ocean.¹¹⁶ The odds were decreasing day by day now. Babakin still had four more scoopers left, and one could be launched in the second week of July 1969 for a repeat attempt. After five straight launch failures of the Proton, engineers and officials could be forgiven for harboring a pessimistic attitude on the chances of success.

The focus of the race to the Moon now shifted to the N1 rocket. By early April, based on the pace of preparations, Mishin had set May 30 as the date for transporting the next flight-ready N1, booster no. 5L, from the assembly-testing building to the launch pad. The launch would be during the lunar launch window in June, on June 13-15, 1969. The preparations for the launch were far more speedy than usual. One participant recalls:

The first launch of the N1 (article 31) aroused dual feelings among those contributing to the events: on the one side [Central Committee] Secretary D. F. Ustinov demanded acceleration of the launch of the "fifth — article 5L." The commotion at the plant rose extraordinarily. The issuing of the complete equipment and nodes for the assembly of the N1 managed to be on the current schedule, the fulfillment of which was overseen personally by the Deputy Minister of Defense of the country. On the other side, people from a multitude of commissions proposed some highly practical [modifications]. . . . However, the events unfolded so fast that many of the conceived measures for the 51 rocket simply physically did not have the time to be "spread out."¹¹⁷

The inevitable delays in the schedule meant that Mishin rescheduled the launch of the rocket from the June launch window to the one in July, just three weeks before Apollo 11. It would be a truly extraordinary few weeks in July, with plans for the launch of the second N1, the second Ye-8-5 lunar scooper, and, of course, Apollo 11.

The launch of N1 booster no. 5L was set for the night of July 3, 1969. The day before, there were rumors from unofficial sources in Moscow that something spectacular was imminent, but all these reports predicted a sample return mission on or about July 10.¹¹⁸ Given the level of activity at the Baykonur Cosmodrome, it is testament to the power of the Soviet shroud

¹¹⁶ *Ibid.* K. Lantratov "The Late Lunar Soil" (English title) *Novosti kosmonautiki* 15 (July 16-29 1994) 41-43; Sokolov "The Race to the Moon."

¹¹⁷ Mikhail Rudenko "Four Steps From the Moon" (English title) *Moskovskaya pravda* July 19 1994 p. 10. The quote is from Vadim Piku.

¹¹⁸ *Soviet Space Programs 1966-70* p. 374. NASA Science and Technology Division, *Astronautics and Aeronautics 1969* p. 195.

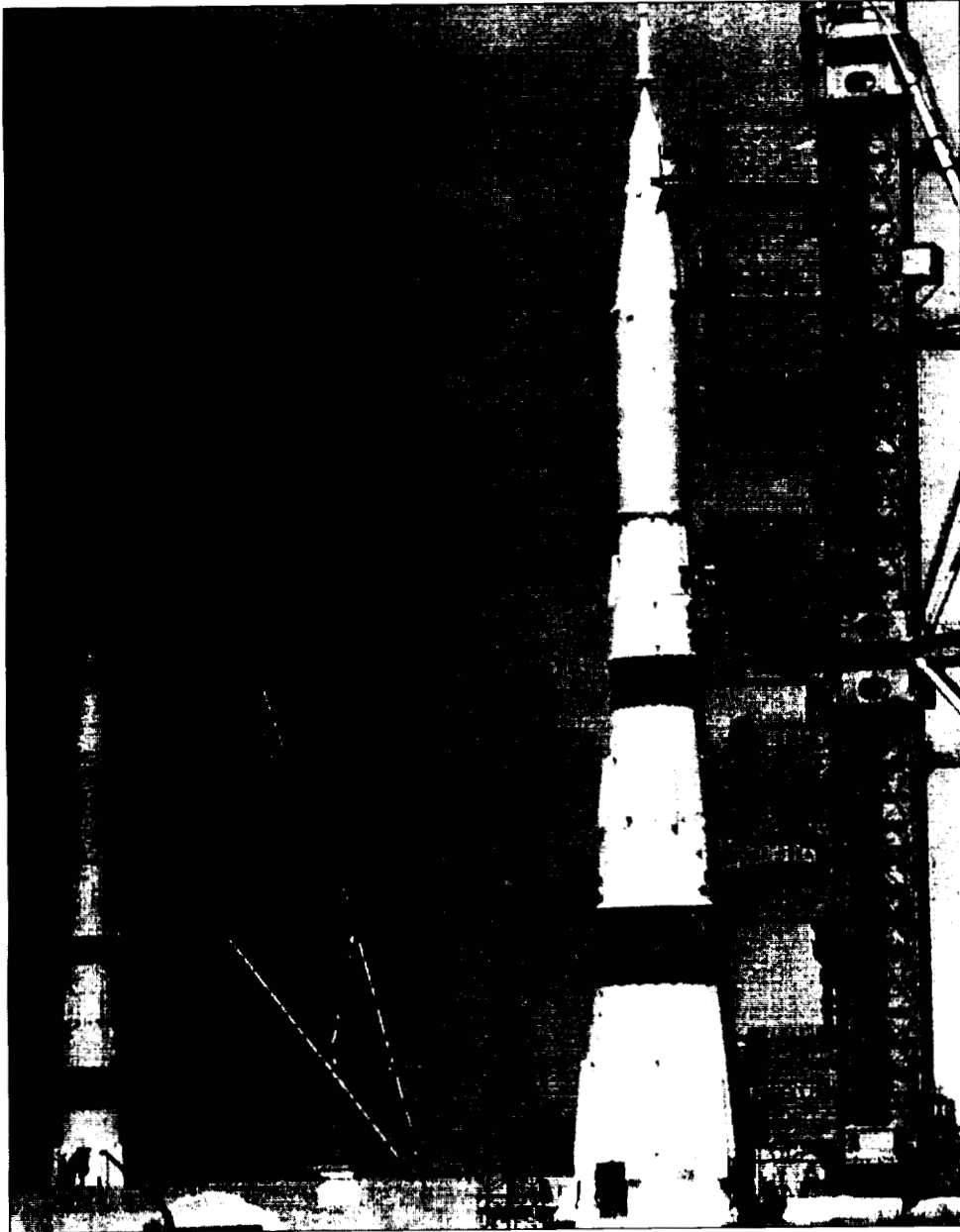

Two N1 Moon rockets appear on the pads at Tyura Tam in early July 1969. In the foreground is booster number 5L with a functional payload for a lunar orbiting mission. In the background is the IM1 ground test mock-up of the N1 for rehearsing parallel launch operations. (files of Asif Siddiqi)

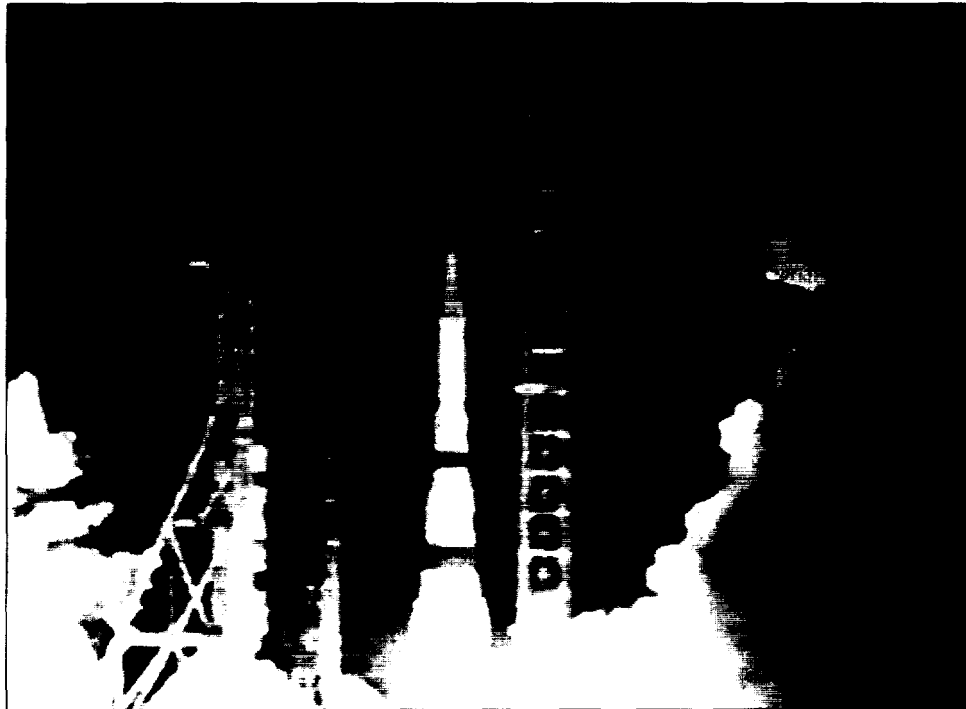

This is the spectacular night launch of the second N1 booster in July 1969. Within seconds the rocket collapsed back onto the pad, destroying the entire pad area in a massive explosion (copyright VideoCosmos Co via Don Pealer/Quest)

the Baykonur Cosmodrome, it is testament to the power of the Soviet shroud of secrecy that, without exception, there was not a single leak to the Western media on any impending launch of a giant booster from Soviet central Asia. The hubbub at Tyura-Tam was unlike anything seen in recent memory. Ministers, deputy ministers, chief designers, senior military officers, and cosmonauts had all flown in for the launch—a final gasp for the sinking hopes of the Soviet reach for the Moon. Valeriy A. Menshikov, then a young lieutenant in the Strategic Missile Forces, who was duty officer at site 112 near the N1 pads, later provided one of the best personal accounts of that fateful night:

There were hundreds of vehicles on the roads with soldiers, officers and civilians. They bore combat banners, documents and various materiel. The dust and heat, the roar of the automobile engines, the human chaos, the congestion and traffic jams, the hoarse shouts of the traffic control personnel—all of this was reminiscent of frames from movies of the first months of the [Second World] war. The only thing missing were German dive bombers.¹⁹

As night fell, Menshikov ordered the launch site group to assemble and then led them away from the rocket to a bunker close to the N1 pad at site 110P to await the launch. Like most observers, lunar cosmonauts Leonov, Makarov, and Rukavishnikov witnessed the launch from a distance of six to seven kilometers. Prelaunch operations began at 0600 hours Moscow Time on

119 Menshikov "The Toilers of the Cosmodrome" p. 40

the morning of July 3 and continued through the day. By 1540 hours, personnel had begun fueling the first three stages, a procedure that was completed within one hour and fifty minutes. Fueling of the L3S payload block began in the early evening at 1900 hours. There were evidently no serious anomalies during the ensuing countdown as the clock ticked closer to midnight.

The N1 ignited to life at exactly 2318 hours, 32 seconds Moscow Time on July 3 (it was after midnight on July 4 at Tyura-Tam). Menshikov remembers the experience vividly:

We were all looking in the direction of the launch, where the hundred-meter pyramid of the rocket was being readied to be hurled into space. Ignition, the flash of flame from the engines, and the rocket slowly rose on a column of flame. And suddenly, at the place where it had just been, a bright fireball. Not one of us understood anything at first. A terrible purple-black mushroom cloud, so familiar from the pictures from the textbook on weapons of mass destruction. The steppe began to rock and the air began to shake, and all of the soldiers and officers froze."

Rukavishnikov's remembrance is almost surreal: he could see the booster double over in an explosion on the pad, but there was no sound. Those few seconds of "deathly silence" lasted an eternity until the full roar of the launch and the ensuing explosion reached the viewing stands." The young Lieutenant Menshikov adds:

Only in the trench did I understand the sense of the expression "your heart in your mouth." Something quite improbable was being created all around—the steppe was trembling like a vibration test jig, thundering, rumbling, whistling, gnashing—all mixed together in some terrible, seemingly unending cacophony. The trench proved to be so shallow and unreliable that one wanted to burrow into the sand so as not to hear this nightmare . . . the thick wave from the explosion passed over us, sweeping away and leveling everything. Behind it came hot metal raining down from above. Pieces of the rocket were thrown ten kilometers away, and large windows were shattered in structures 40 kilometers away. A 400 kilogram spherical tank landed on the roof of the installation and testing wing, seven kilometers from the launch pad."

By some estimates, the strength of the explosion was close to 250 tons of TNT—not a nuclear explosion, but certainly the most powerful explosion ever in the history of rocketry. The booster had lifted off to a height of 200 meters before falling over and exploding on the launch pad itself, about twenty-three seconds after launch. The emergency rescue system fired in the nick of time, at T+14.5 seconds, to shoot the descent apparatus of the payload two kilometers from the pad, thus saving it from destruction. Remarkably, no doubt because of the stringent safety precautions, there were no fatalities or injuries, although the physical devastation was phenomenal. When the first teams arrived near the pad in the early-morning hours of July 4, there was only carnage left behind:

We arrived at the fueling station and were horrified—the windows and doors were smashed out, the iron entrance gate was askew, the equipment was scattered about

120 *Ibid*

121 Rudenko. "Four Steps From the Moon," p 10

122 Menshikov. "The Toilers of the Cosmodrome," p 40

with the light of dawn and was turned to stone—the steppe was literally strewn with dead animals and birds. Where so many of them came from and how they appeared in such quantities at the station I still do not understand."

By 0800 hours the morning of July 4, Minister of General Machine Building Afanasyev had convened a meeting of the State Commission and began the long process of determining the reasons behind the disaster by looking at films of the launch and analyzing telemetry. Afanasyev also telephoned Brezhnev and Kosygin, the latter of whom was particularly dissatisfied with the results. Perhaps most sobering of all was Chief Designer Barmin's assessment on the destruction of the launch area. The right launch pad at site 11OP was completely destroyed: the explosive force also displaced the 145-meter-tall service tower from its rails and destroyed all the special ground equipment of the launch installation, including a lightning arrester. The top two and a half floors of the five-story underground pad support structure had collapsed.¹²³ The left launch pad at site 11OL had remained unscathed. A second N1 had in fact been mounted at the pad during the failed launch presumably to rehearse dual launches planned for later in the lunar program. Barmin believed that restoration of the destroyed complex would be faster and cheaper than building a completely new one.

To pursue an investigation of the accident, Afanasyev created a commission headed by Chief Designer Mishin; this commission consisted of seven subcommissions for particular areas of the N1 rocket.¹²⁴ The stress of the previous few months of relentless work seem to have taken their toll on the fifty-two-year-old Mishin; at a meeting three days after the disaster, he suffered serious heart trouble, although he was apparently back at work very soon after. Beginning on July 4 and continuing through the waning weeks of July, the commission focused on malfunctions in the KORD engine control system. It was immediately clear after the accident that at least five engines had been turned off within one second of ignition. According to early data, KORD turned off all engines save one, engine no. 18, about ten seconds into the mission. Engineers also detected early on a short circuit in an oxygen line in the area of two other engines, nos. 8 and 9. But the question remained: Why had KORD shut the engines down in the first place? By July 11, a researcher from the P. I. Baranov Central Institute of Aviation Motor Building was able to report that perhaps a foreign object had entered an NK-15 engine's oxygen pump, causing a cascade of failures. By the time of Mishin's visit to Kuybyshev on July 16 for

¹²³ *Ibid.*, p. 40. A U.S. CORONA photo-reconnaissance satellite photographed the aftereffects of the pad explosion by early August 1969. One such picture, taken on CORONA mission 1107 during pass 169 on August 3, 1969, has been published. See the back cover of *quest* 4(2) (Summer 1995). CORONA information was probably the primary basis for a description of the N1 launch failure in a top-secret CIA document from March 1970. See U.S. Central Intelligence Agency, "National Intelligence Estimate 111-69 The Soviet Space Program," Washington, D.C., March 26, 1970, p. 1, as declassified in 1997 by the CIA Historical Review Program. News of the disaster eventually leaked out into the open media. The first revelations emerged on November 17, 1969, simultaneously in Great Britain and the United States. See Stuart Auerbach, "Soviet Moon Rocket Exploded in Test," *Washington Post*, November 18, 1969, p. A1; "Soviets Suffer Setbacks in Space," *Aviation Week & Space Technology*, November 17, 1969, pp. 26-27; "Disaster at Tyuratam," *Time*, November 28, 1969, p. 27. Curtousiy, the February 1969 launch attempt was never detected by Western intelligence, although they apparently did expect a launch in early 1969. See "Countdown for Biggest Rocket Yet," *Newsweek*, February 24, 1969, p. 28; Donald C. Winston, "Soviet Space May Include Large Booster Test," *Aviation Week & Space Technology*, March 10, 1969, pp. 132-33.

¹²⁴ Rudenko, "Four Steps From the Moon." Note that another source says that "all six underground levels of the launch structure were destroyed by the explosion." See Barmin and Shamsutdinov, "Soviet Programs for Piloted Flight to the Moon."

¹²⁵ The subcommissions were headed by N. D. Kuznetsov (engines), G. I. Degtyarenko (temperatures and loads), A. G. Iosifyan (electrical supply), V. P. Finogeyev (guidance and control systems), Ye. V. Shabarov (launch escape system), B. A. Dorofeyev (specialty unknown), and Kupavin and Dorofeyev (KORD).

discussions with engine Chief Designer Kuznetsov as well as his own First Deputy Kozlov, there were four likely reasons for the accident out of a possible seven at the beginning of the investigation.

The search for the causes of the disaster would continue on for many months. but the damage inflicted not only on hardware but also on the spirits of Soviet engineers on the night of July 3, 1969, was irreparable. Kamanin wrote in his diary the day after the accident:

Yesterday the second attempt to launch the NI rocket into space was undertaken. I was convinced that the rocket would not fly, but somewhere in the depth of my soul there glimmered some hope for success. We are desperate for a success, especially now, when the Americans intend in a few days to land people on the Moon, and when the American astronaut Frank Borman is our guest. But all such hopes were dispelled by the powerful explosion of the rocket five seconds after the "launch" command. . . on its first time, the rocket flew 23 kilometers, and did not cause harm to the launch platform and launch site. This time it fell two kilometers [sic] from the pad and caused huge damage to the launch site. This failure has put us back another one to one and a half years.¹²⁶

Soviet Ambassador to the United States Anatoly Dobrynin had indeed invited Apollo 8 astronaut Colonel Frank Borman for a nine-day visit to the USSR. Although Borman and his family were not considered official guests of the Soviet government, it was the first visit of an American astronaut to the country. On the night of July 4, 1969, Borman was present at the U.S. embassy's reception to celebrate Independence Day. The timing could not have been worse for the Soviets. Instead of being feted by reporters on a new success in space, Soviet cosmonauts were on hand. less than twenty-four hours after the catastrophe at Tyura-Tam, glum and reticent. When asked about the possibility of a Soviet lunar scooper timed to fly before Apollo 11, Beregovoy, Feoktistov, and Titov declined to confirm or deny the rumors..! The following day, Borman visited the Gagarin Cosmonaut Training Center, where he was received by the newly appointed Commander-in-Chief of the Soviet Air Force Marshal Pavel S. Kutakhov and Col. General Nikolay P. Kamanin. "The many cosmonauts attending the function could only watch in damaged pride as the NASA astronaut gave an impressive slide show of his recent flight to the Moon.

Through their despair, the Soviets had one final gasp left: a flight of the Ye-8-5 sample return spacecraft during the July launch window. If it succeeded, the mission would vindicate their recent abrupt emphasis on automation versus piloted flight. Even more dramatic would be a success for the scooper if Apollo 11 failed. Such a scenario, no doubt given consideration during those desperate weeks in early July, would have, in one fell swoop, eliminated all the failures, explosions, and delays of the year so far.

Chief Designer Babakin's engineers prepared his spacecraft, Ye-8-5 vehicle no. 401, for launch at the same time that workers were scouring the remains of the NI at Tyura-Tam. There were problems with the mass of the spacecraft right up until the final days before launch. Engineers calculated that the ascent stage of the robot, called the RYe-85, had a mass of 5133.3 kilograms instead of the allotted 512 kilograms. After much soul searching, Babakin ordered the deletion of one of two 1.28-kilogram radio transmitters on the ship, leaving the primary one with no backup. It was a gutsy move, underlining the risks inherent in the mission in general. The launch itself was a blessing. After five straight failures of the Proton launch vehicle, the rocket lifted off on time at 0554 hours, 41 seconds Moscow Time on July 13, 1969: precious payload was deposited on a perfect trajectory heading for the Moon. The Soviet press, announcing the

126 Kamanin, "I Feel Sorry for Our Guys," no. 13

127 James F. Clarity, "Top Soviet Aides Observe the 4th " *New York Times* July 5, 1969

128. Riabchikov, *Russians in Space*, pp. 265-66

mission as Luna 15, merely stated that the spacecraft would study circumlunar space, the Moon's gravitational field, and the chemical composition of lunar rocks, and would carry out surface photography.¹²⁹

The world's eyes and ears, however, were not on the Soviet spacecraft, but on the three American men who set off for the Moon on July 16, just three days after the launch of Luna 15. For a brief moment, Apollo 11 astronauts Neil A. Armstrong, Michael Collins, and Edwin E. Aldrin, Jr., represented not only NASA and not just simply the United States, but, in the justifiably hyperbolic language of the day, all humanity itself. But there was also a more earthly aspect of the mission, too: they carried the baton on the last lap of the "space race," inaugurated by the Soviet Sputnik twelve years previously. This more political dimension had gradually receded from the foreground as it seemed that the Soviets had, for reasons unclear, relinquished their claim to answer President Kennedy's challenge. For Soviet space engineers, however, the "space race" as a living artifact was far more imposing in 1969 than to their counterparts across the ocean. Their last hopes were pinned on Luna 15 much more than anyone would care to admit at the time.

The responsibility of directing the Luna 15 mission fell on the shoulders of First Deputy Minister of General Machine Building Georgiy A. Tyulin, the fifty-four-year-old retired artillery general whose career in the missile and space industry had now spanned more than twenty-five years. Tyulin, as chair of Luna 15's State Commission, ran into trouble with the spacecraft after only one day of flight. Controllers detected unusually high temperatures in the propellant tanks of the S5.61 engine, which would be used for takeoff from the lunar surface after the collection of the lunar sample. With the specter of a possible explosion of the entire engine complex en route to the Moon, Tyulin assembled all the senior program engineers, including Chief Designer Babakm. After a quick analysis, some participants proposed a seat-of-the-pants method of turning the spacecraft in such a way as to keep the suspect tank in the Sun's shadow at all times. Despite some acrimonious exchanges and stiff resistance from engineers, Tyulin sided with trying the unorthodox procedure: telemetry later showed that the tank temperature stabilized at acceptable levels.¹³⁰

Luna 15 fired its main engine to enter lunar orbit at 1300 hours Moscow Time on July 17. Engineers planned two major orbital corrections prior to landing on the Moon. The first (KIII) on July 18 was to bring the spacecraft's perigee to sixteen plus or minus four kilometers altitude. If the altitude was too high, then there would be insufficient propellant to brake the ship down to the surface, and if it was too low, then there would not be enough time to slow the vehicle down for a survivable landing. The second correction (KIV) on July 19 would determine the longitude of the ascending node to posit the ship over the precise landing corridor. The State Commission did not, however, anticipate the ruggedness of the lunar surface, and the altimeter showed wildly varying readings for the projected landing area. Controllers instead spent three to four days carefully analyzing incoming data. Over twenty to twenty-two communications sessions per day, engineers laid the groundwork for carrying out corrections, built a support system of coordinates, established thrust orientation vectors, and carried out trajectory measurements over consecutive orbits. Two carefully prepared maneuvers were carried out at 1608 hours on July 19 and at 1716 hours on July 20, the latter putting the spacecraft into the planned 110- by sixteen-kilometer orbit at a retrograde Inclination of 127 degrees.¹³¹

129 *Soviet Space Programs 1966-70* pp 196 Babakin Banketov and Smorkalov *Ç N Babakin* p 64

130 Babakin Banketov and Smorkalov *Ç N Babakin* pp 60-62

131 *Ibid* pp 62-63 Lantratov "The Late Lunar Soil" The orbit after the first correction was 221 by ninety five kilometers



Some members of the State Commission for the Luna sample return spacecraft are shown in a photo from 1970 at Simferopol. Sitting in the foreground from left to right are Commission Chairman Georgiy Tyulin, Chief Designer Georgiy Babakin and Minister of General Machine Building Sergey Afanasyev. The tall figure standing at the back on the right is Yuriy Koptev, the current director of the Russian Space Agency who was an engineer at the Lauchkin design bureau at the time. Sitting in the second row at left is Academician Boris Petrov, one of the principal international spokespersons for the Soviet space program. (copyright Asif Siddiqi)

The Western press closely followed the mission of Luna 15. Kenneth Gatland, a respected British journalist who hosted the Apollo 11 broadcasts for British television, recalled:

Even as the Apollo 11 programme was on the air, and we sat before the cameras discussing how Neil Armstrong and Edwin Aldrin would land, the Russian robot was maneuvering in orbit. There was even the suggestion from one scientist that Russia might be preparing to set down on the Moon a mooncraft capable of rescuing the Americans if, by some accident, they were stranded on the Moon! To the delight of the TV producers, the drama was kept up until the last.¹³²

Even NASA, busy as it was with Apollo 11, managed to join in the drama of the race. The Apollo 11 crewmembers were kept apprised of the progress of Luna 15. There was also some concern that Luna 15's orbit might, in an unlikely situation, interfere with that of Apollo 11.

¹³² Gatland, *Robot Explorers*, p. 145

Astronaut Borman played a critical role in passing on detailed orbital information on Luna 15 from the Academy of Sciences to the White House, which evidently laid to rest any fears the Apollo flight control might have had back in Houston."

To Western observers, the closeness of the race in lunar orbit was without precedent. A little less than six hours after Luna 15's second and final orbital correction, the Apollo 11 Lunar Module began its voyage toward the lunar surface. After a thrill-laden descent, the two astronauts, Armstrong and Aldrin, safely put down the ungainly looking lander onto the lunar surface at 2017 hours CMT on July 20. In Moscow, it was 2317 hours, close to midnight. Luna 15, meanwhile, was still in orbit, as controllers pored over their data. Originally, their plan was to put down the robot less than two hours after Apollo 11. The delays in mapping out a correct trajectory for Luna 15, however, took their toll. Unsure of the terrain below, Tyulin delayed the landing a full eighteen hours, awaiting a final and unanimous affirmative from his engineers. During this no doubt demoralizing period, Neil A. Armstrong exited the Lunar Module and set foot on the surface of the Moon.

As a mesmerized world watched the ghostly images of human beings walking on another celestial body, Luna 15 became a footnote to history. Tyulin's State Commission finally commanded the robot to fire its descent engine at 1847 hours Moscow Time on July 21, a little more than two hours prior to the planned liftoff of Armstrong and Aldrin from the Moon. It was the spacecraft's fifty-second orbit around the Moon. Controllers impatiently followed the signals from Luna 15 as it descended swiftly to the lunar surface. Landing would be six minutes after the beginning of powered descent. To the collective shock of all those present, transmissions abruptly ceased four minutes after deorbit, at an altimeter reading of three kilometers." Later analysis showed that the spacecraft had unexpectedly hit the side of a mountain at a velocity of 480 kilometers per hour. The impact point was at 12° N, 60° E in Mare Crisium. The Soviet news agency TASS characteristically announced that Luna 15's research program had been completed and the spacecraft had "reached" the Moon in the "preset" area.¹³⁵ There was one small irony to the whole mission. Even if there had not been a critical eighteen-hour delay in attempting a landing, and even if Luna 15 had landed, collected a soil sample, and safely returned to Earth, its small return capsule would have touched down on Soviet territory two hours and four minutes after the splashdown of Apollo 11. "The race had, in fact, been over before it had begun.

Armstrong and Aldrin, meanwhile, lifted off successfully, and with crewmember Collins, headed back to Earth, splashing down safely in the Pacific Ocean on July 24, 1969, concluding one of the most dramatic voyages of exploration in the history of humankind. Outside the USSR, Soviet officials were unusually magnanimous in their praise of this incredible feat, but within the country, to their own citizens, they were less than generous. By the end of the 1960s, official Soviet doctrine had showed a marked positive evaluation and reportage of American space achievements, but Apollo 11, given its paramount importance as a defining moment of the space race, was an anomaly. Many within the space industry, including TsNIIMash Director Mozhorin, were themselves responsible for deemphasizing the importance of Apollo 11, perhaps partly to hide their own shortcomings. In the glasnost days of reevaluating the black holes of Soviet history, one Soviet journalist wrote with undisguised vitriol:

133 Slayton and Cassutt, *Dekel*, p. 240; *Soviet Space Programs 1966-70*, p. 196

134 Babakin, Banketov, and Smorkalov. *G. N. Babakin*, pp. 63-64; Lantratov, "The 'Late' Lunar Soil "

135 *Soviet Space Programs 1966-70* p. 197; Rebrov, "But Things Were Like That "

136 Lantratov, "The 'Late' Lunar Soil "

The task of Mozzhorin's group consisted of misinforming the public and concealing from the people the blunders and the real state of our affairs in space. But the deception became obvious when, on July 21, 1969 . . . Neil Armstrong became the first earthling to set foot on the surface of the Moon and planted the American flag. Our deceitful propaganda, supervised then by M. A. Suslov (now one of Moscow's boulevards has been named after him), was forced to show this historical event on our television screens during a volleyball match between two local teams.¹³⁷

The news itself was not accompanied by any TV footage, merely a dry news report. Actual video of the landing was evidently restricted to a select group within the Soviet Union, including the chief designers.

With the final and ignominious end to the "race to the Moon," the uncertainty of the numerous pronouncements of the last eight months disappeared, replaced by two clear and consistent themes: the Soviet objective to explore the Moon by automated means and the longstanding goal of establishing piloted orbital space stations in Earth orbit. Implicit, of course, in both these themes was the claim that the Soviet Union had never planned to send humans to the Moon because its program had always been geared more toward scientifically productive rather than politically motivated objectives. Academician Blagonravov claimed on Moscow Radio on July 21 that the only advantage of sending cosmonauts to the Moon was to provide freer choice in picking up Moon rocks. He emphasized that the space programs of the two superpowers had moved at about the same pace but along parallel paths.¹³⁸ Even if he knew of the existence of the N1-13 program, he would have been committing treason against the state had he stated that the Soviet Union had indeed tried to race the Americans to the Moon. Later in the month, in another statement, he added that Soyuz spacecraft would be converted into "modules of orbital space laboratories designed for research in lengthy flight."¹³⁹

Salvaging the wreckage of the Soviet piloted space program was not an easy task. Discussions in early 1969 had given focus to three possible future tracks:

- A piloted Mars mission
- Improved lunar landing missions
- Earth-orbital space stations

Publicly, Soviet spokespersons focused only on the third item. Academician Sedov, for example, on a visit to Japan in late August 1969, claimed that a new type of "spacecraft" would be used to put a large space station into Earth orbit. There was, he said, no necessity in sending humans to the Moon because automated lunar probes could return soil back to Earth.¹⁴⁰ The decision to move ahead with space stations was, however, fraught with much more internal acrimony than Sedov's statement would suggest. The three major possibilities available to the Soviets in the post-Apollo 11 climate raised not only the hope of restoring prestige to a rudderless Soviet space program, but also gave rise to yet more acrimony among the major players in the industry. The lessons of losing the Moon race had, it seems, not been learned very well.

¹³⁷ German Nazarov "You Cannot Paper Space With Rubles How to Save Billions" (English title) *Molodaya gvardiya* no. 4 (April 1990) 192-207

¹³⁸ *Soviet Space Programs 1966-70* p. 375

¹³⁹ NASA Science and Technology Division, *Astronautics and Aeronautics 1969* p. 256

¹⁴⁰ *Soviet Space Programs 1966-70* p. 376. Disingenuously, Sedov added that a soft landing had not been a goal for Luna 15; the spacecraft had been "sent to study the Moon from lunar orbit."

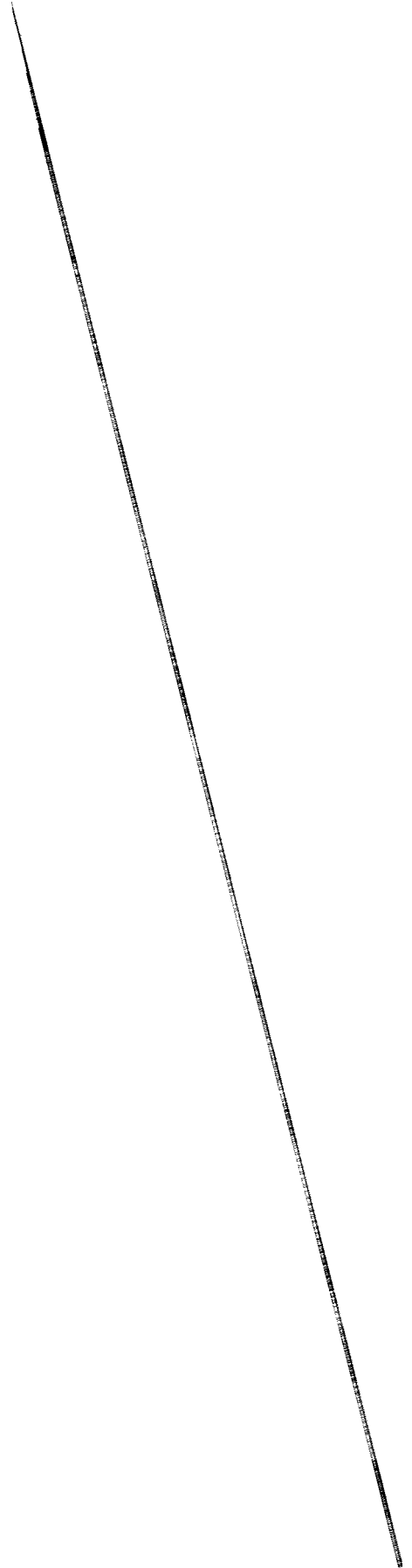



CHAPTER SIXTEEN

OPTIONS

Conventional wisdom would suggest that after such a fatal blow as the triumphant landing of American astronauts on the Moon, the Soviet Union would simply fall back into a period of conservatism, characterized more by self-appraisal rather than any further grand gestures at competition. But Soviet officials, from the highest arbiter of the Soviet space program, Dmitriy F. Ustinov, down to the lowest engineers, differed in one key respect to their American counterparts. For the Soviets, the race to the Moon might have been over, but the less specific "space race" was not. Ironically, it was, in fact, the American space program that entered an uncertain period of soul searching as it sought to define a direction in the post-Apollo frontier—a direction that for the first time was not determined exclusively by Cold War competition with the Soviet Union. The Soviets, on the other hand, continued to propose, define, and implement newer programs, which harked back to political imperatives of the Kennedy-Khrushchev era. If the Americans had beaten the Soviets to the Moon, then the Soviets would beat them to Mars. If the Americans were going to build a space station in Earth orbit, then the Soviets would build one sooner. While Soviet motivations in late 1969 were a little more complex than such simplistic rhetoric, by and large, the Soviet space program did not abandon the space race in 1969. In fact, its piloted lunar programs continued to serve as a major force in policy. years after Neil A. Armstrong stepped on the Moon in July 1969.

Rummaging Through the Wreckage

Much of the activity in the Soviet program during the latter part of 1969 resulted more from inertia rather than any new goals. As policy planners gradually sought to establish clear directions for the overall effort, space vehicles intended for flight earlier in the decade were finally ready for launch. With little to lose after Apollo 11, Ustinov, Smirnov, and Afanasyev allowed some token launches in the piloted lunar program, which on superficial examination seem to make little sense. The first such mission was a circumlunar flight of the 7K-L1 spacecraft in the late summer of 1969. Although the piloted component of the circumlunar program had been officially suspended in March 1969, Chief Designer Mishin continued flights of the trouble-prone spacecraft in the hope of flying crews on board at some uncertain time in the future. Carrying out a simple automated circumlunar mission less than a month after Apollo 11 might indicate a disregard for public perceptions of the Soviet space program, but the timing of the launch was apparently more of a coincidence than anything else. The Soviets did, however, go to great lengths to play down news of the mission.

As with previous L1 launches, cosmonauts were present at the Baykonur Cosmodrome, although this time they were involved to a greater degree in flight operations. Leonov and

Makarov trained to acquire skills of "controlling the [descent apparatus] as operators" in preparation for a piloted flight. The 7K-L1 spacecraft, vehicle no. 11, had been the last model manufactured for automated flight and contained mannequins. The ship was, however, redesigned for piloted flight with powered control panels and blocks removed from the switches. The spacecraft lifted off from the Baykonur Cosmodrome at 0248 hours, 6 seconds Moscow Time on August 8, 1969, and successfully headed toward the Moon an hour later. Called *Zond 7* by the Soviet press, the ship, like its predecessors, carried a menagerie of living specimens, including four Steppe male tortoises, which were part of a group of thirty tortoises selected for a biological study.¹ The spacecraft was said to have been equipped with improved instrumentation, although few details were provided. After a mid-course correction at a distance of 250,000 kilometers from Earth on August 9, the ship circled the far side of the Moon at a range of 1,200 kilometers two days later. The only anomaly on the flight was a communications problem—the main parabolic antenna failed to unfurl because of a jam in the securing cables—although this did not prevent the accomplishment of any of the main flight objectives.²

For the first time on a Zond mission, the on-board camera took color photographs. The first session took place on August 8 when the camera took pictures of Earth at a distance of 70,000 kilometers, clearly showing a large part of the globe, including Asia, Africa, and the Middle East. Three days later on August 11, there were two further sessions. The first ten-minute run was at a distance of 10,000 kilometers when the ship was closing in on the Moon: it covered the western side of the Ocean of Storms and nearby heavily cratered areas. An hour later, the spacecraft took a further series of photographs showing far side features from a range of 2,000 kilometers. Several of these spectacular shots were reminiscent of those taken by Apollo astronauts, with Earth majestically setting over the Moon's horizon. Although the Moon generally tends to look gray, scientists hoped that color photos from different angles might reveal differences in its microstructure. Apart from photography, the spacecraft also performed "measurements of the physical characteristics of circumlunar space as well as technical experiments for developing motion controlling systems with the onboard [computer], astro-orientation systems, deep space communications apparatus, and other onboard systems."³

The Zond 7 spacecraft flew back to Earth without incident, once again flying over the South Pole and then moving north over the Indian Ocean. It entered the correct corridor on August 14, lost velocity, skipped out, and then reentered again for a perfect, aerodynamically controlled reentry onto Soviet territory. Parachutes deployed at an altitude of seven and a half kilometers and soft-landing engines fired a meter above the ground for a faultless touchdown south of Kustanay in Kazakhstan, just fifty kilometers from the intended target point. The mission had lasted six days, eighteen hours, and twenty-five minutes. Two years later, TsKBEM finally accomplished a fully successful 7K-L1 circumlunar mission. It was, of course, too late for

1 Yu P Semenov ed *Raketno Kosmicheskaya Korporatsiya 'Energiya' imeni S P Koroleva* (Korolev RKK Energiya named after S P Korolev 1996) p 246

2 O C Gzenko V V Antipov and G P Parfenov 'Results of Biological Investigations Undertaken on the Zond 5 Zond 6 and Zond 7 Stations' (English title) *Kosmicheskiye issledovaniya* 9 (July-August 1971) 601-09 Other specimens included air dried cells of wheat barley peas pines carrots tomatoes mustard bulbs of common onion one strain of single celled chlorella algae and a culture of lysogenic bacteria

3 V P Glushko ed *Kosmonautika entsiklopediya* (Moscow Sovetskaya entsiklopediya 1985) p 130 Semenov ed *Raketno Kosmicheskaya Korporatsiya* p 246

4 Glushko ed *Kosmonautika entsiklopediya* p 130 Soviet Space Programs 1966-70 Goals and Purposes Organization Resources Facilities and Hardware Manned and Unmanned Flight Programs Bioastronautics Civil and Military Applications Projections of Future Plans Attitudes Toward International Cooperation and Space Law prepared for the Committee on Aeronautical and Space Sciences U S Senate 92d Cong 1st sess (Washington DC U S Government Printing Office December 1971) p 244 Kenneth Gatland *Robot Explorers* (London MacMillan 1972) p 150

politicians to extract any mileage from the resounding success of Zond 7, coming as it did less than a month after the American lunar landing. But the conclusion of the mission did raise the possibility of moving ahead to piloted missions on the L1 spacecraft. At a meeting of the L1 State Commission on September 19, 1969, the members discussed such an option. The Air Force Commander-in-Chief's Aide for Space Col. General Kamanin recalled that "the success of Zond-7 . . . gave some encouragement to Mishin, Tyulin, and Afanasyev who were gradually recovering from the shock caused by the failure of the N1 and the brilliant Apollo missions." The State Commission tentatively decided to make use of the three remaining 7K-L1 spacecraft still left on the ground. The first would be launched in early December 1969 on an automated flight followed by the second in April 1970, perhaps carrying the first Soviet cosmonauts around the Moon. While Mishin and State Commission Chairman Tyulin may have wished for such, the forces against piloted L1 missions were too overwhelming. There was little to be gained politically from a piloted L1 mission at this point. Both Brezhnev and Ustinov had more or less decided on the program's termination in the spring of 1969, and the plans to launch a crew in April 1970 eventually died a quiet death. By the end of 1969, the piloted portion of the UR-500K-L1 project was irrevocably over, and while Mishin had plans to fly the remaining unflown vehicles, these were redirected toward primarily technological goals.

The dilemma facing Soviet space planners in the direct aftermath of the Apollo landing was how to respond in the immediate months. What kind of a piloted mission could be mounted in the waning months of 1969 that would not underline the weak position of the USSR in comparison to the United States in the exploration of space? In the landmark January 1969 meetings after Apollo 8, Minister of General Machine Building Afanasyev had suggested a thirty-day Soyuz mission in Earth orbit. A month later, Soyuz State Commission Chairman Maj. General Kerimov emerged with a more modest seven-day Earth-orbital flight of two cosmonauts in a Soyuz ship. Space program chief Ustinov wanted more, telling the commission that a seven-day mission was too "thinnish" and that "it should be thick."⁶ Kamanin, on February 11, underlined the confusion in how to proceed with the Soyuz program, writing in his diary:

We have reached a fully absurd [situation]. there is not one man in this country who would be able to say what the next flight into space will be. *Ustinov* does not know this. *Keldysh*, *Smirnov*, and *Mishin* do not know this—generally no one *knows!* All my attempts to obtain *from* the state the composition of plans for *piloted* space flights lead nowhere: there are no such plans, and it is most unlikely that there will be.⁷

Originally, prior to the Soyuz 4/5 docking-and-EVA mission in January 1969, Mishin had had plans to fly repeat Earth-orbital flights of the 7K-OK Soyuz spacecraft, but equipped with the Kontakt rendezvous radar system earmarked for the lunar version of the Soyuz instead of the less advanced *Igla*. While Kontakt was not ready for flight at the time, the Soyuz 4/5 repeat mission plans offered an answer on how to formulate a response to Apollo. By late February, Mishin's idea was to launch three 7K-OK Soyuz spaceships into Earth orbit, two of which would dock automatically with each other, while the third would hover at 300 to 400 meters range by means of manual control and take photographs of the experiment.⁸ Although a poor

5 N. Kamanin "I Feel Sorry for Our Cuiys" (English title) *Vozdushniy transport* 14 (1993) 11

6 N. Kamanin "I Feel Sorry for Our Cuiys" (English title) *Vozdushniy transport* 13 (1993) 8-9

7 *Ibid*

8 Dmitriy Payson "Eternal Soyuz—Today Marks the 25th Anniversary of the First Docking in Orbit" (English title) *Nezavisimaya gazeta* January 15 1994 p. 6 Christian Lardier *L'Astronautique Soviétique* (Paris Armand Colin 1992) p. 188

match for a lunar mission, such a flight would not only demonstrate the capacity of the Soviet space program to perform complex operations in space, but also provide a long overdue public relations extravaganza from the potentially spectacular photographs. On a purely technical level, the flight would also allow engineers to perfect rendezvous and docking operations and control multiple vehicles in orbit in preparation for future space station missions.

By April 1, 1969, Mishin had a short-range plan for the 7K-OK Soyuz program:

Missions	Dates
Soyuz 6, 7, and 8	Triple flight in August 1969
Soyuz 9 and 10	Docking flight in October 1969
Soyuz 11 and 12	Docking flight in February 1970

Apart from rendezvous and docking, the triple joint mission would have other important elements. A special unit named the *Vulkan* ("Volcano") was installed on Soyuz 6 (spacecraft no. 14) to allow its crew to carry out a complex series of welding operations in conditions of microgravity and vacuum. The Ye. O. Paton Institute for Electro-Welding based at Kiev had developed the unit on a contract handed out during the Korolev era. Cosmonaut Fartushniy, a scientist from the institute, had been slated to fly the Vulkan unit into space, but by April, he had been moved from Soyuz 6 to Soyuz 11, evidently because of mass constraints when the crew size was reduced from three to two.⁹ Additional instrumentation on Soyuz 6 included the Svinets apparatus, a military experiment for detecting and identifying the plumes from ICBM launches. The triple ship experiment would have a record seven cosmonauts flying in space simultaneously, most of whom had been training in various capacities on the piloted circum-lunar and landing projects during the previous two years.¹⁰ The two final docking missions—Soyuz 9/Soyuz 10 and Soyuz 11/Soyuz 12—would include at least one very long-duration mission to reclaim the absolute endurance record for a space mission, held for almost four years by NASA's Gemini VII mission. These four missions would also use the long-delayed Kontakt rendezvous system.¹¹

Mishin discussed these plans with Ustinov during a meeting on June 7, 1969, but the possibility of carrying out the triple Soyuz mission quickly gained a new urgency after the second catastrophic blow to the Soviet space program in eight months, the Apollo 11 landing. Once the inevitable delays crept into the ambitious Soyuz plan, Soviet space program leaders began to get cold feet. In late September, less than two weeks before the projected launches, Chief Designer Mishin met again with Ustinov to discuss preparations for the triple mission. Mishin noted in his personal office notes that "there is a fear in taking decisions."¹² Ustinov forbade Mishin to begin propellant loading of the boosters and spaceships, despite the latter's protest to adhere to the original program. Ustinov told Mishin that the final decision to proceed with

⁹ Fartushniy was to have flown in the third seat on Soyuz 6. See Rex Hall, "Soviet Civilian Cosmonauts" in Michael Cassutt, ed., *Who's Who in Space: The International Space Year Edition* (New York: Macmillan, 1992), pp. 290-91.

¹⁰ On April 7, 1969, the planned crews for the three ships were G. S. Shonin/V. N. Kubasov (Soyuz 6), A. V. Filipchenko/V. N. Volkov/V. V. Corbatko (Soyuz 7), and A. C. Nikolayev/V. I. Sevastyanov (Soyuz 8). The backup crewmembers were A. P. Kuklin, C. M. Crechko, and P. I. Kolodin. The crews began training for the missions on April 10, 1969.

¹¹ The crews for the last four missions were (on April 7, 1969) Ye. V. Khrunov/A. S. Yeliseyev (Soyuz 9), A. P. Kuklin/C. M. Crechko (Soyuz 10), V. A. Shatalov/V. G. Fartushniy (Soyuz 11), and G. S. Shonin/V. A. Yazdovskiy/V. I. Patsayev (Soyuz 12).

¹² Interview, Peter Gorin by the author, November 18, 1997.

the launches would be discussed at the Politburo level, an unusual state of events for a space launch. It is quite likely that Soviet leaders such as Brezhnev and Kosygin were extremely sensitive to the possibility of a catastrophic failure in the Soviet space program so soon after Apollo 11; such a mission would also once again raise the question of the direction of the Soviet space program. How were officials to answer to the obvious comparisons with Apollo?

On September 29, Mishin spoke with Ustinov, Smirnov, and Afanasyev. The chief designer had already received permission to begin fueling the first Soyuz, spacecraft no. 14, but was still awaiting approval to move ahead with prelaunch preparations for vehicle nos. 15 and 16. The Politburo met a day later and finally granted permission to carry out the triple flight. The mission would be touted as a major step in the creation of Earth-orbital stations, the "true calling" of the Soviet space program. The activity leading up to the launches was further intensified by major changes in the crew complement of the three Soyuz vehicles. Originally, the third Soyuz—the active vehicle during the docking exercise—would have been crewed by cosmonauts Nikolayev and Sevastyanov. Colonel Nikolayev, the veteran from the Vostok days, would also serve as the overall commander of all seven cosmonauts in space. Unfortunately for him, he had performed poorly during a preparatory exam in late July 1969.¹³ Perhaps expecting an improvement in his abilities, planners continued to maintain the original crew complements until September 17, when Mishin and Kamanin agreed to replace the Nikolayev-Sevastyanov crew with a new two-cosmonaut crew fresh off their own recent spaceflights: Shatalov and Yeliseyev. Shatalov, of course, had the distinction of being the only Soviet cosmonaut who had actually carried out a docking in space, and his inclusion in the crew for the third Soyuz was probably a boon to confidence. A final decision on the crew replacement was taken in early October, after all the primary and backup cosmonauts for the three ships had arrived at the Baykonur Cosmodrome.¹⁴

Apart from the uniqueness of having three Soyuz ships in orbit at the same time, the joint flight would also mark a significant expansion of Soviet communications capabilities. Transmissions were normally limited to flight over the Soviet landmass or with a small flotilla of modest seafaring vessels under the control of the Department of Naval Expeditionary Work under the Academy of Sciences since 1967. That same year, the Soviets began the construction of the first of a new generation of vastly improved tracking ships. The first of these, with a displacement of 17,850 tons, was the Kosmonaut Vladimir Komarov, a Poltava-class dry cargo vessel that was converted to its new role at Leningrad in 1967. The 121-strong crew and 118-member science team were three and seven times larger, respectively, than predecessors such as the *Dolinsk*. The prominent features of the Kosmonaut Vladimir Komarov were the unusual hull sponsons and the massive plastic radomes, which enclosed huge antenna arrays for tracking and communications. For the Soyuz program, the ship would serve as one node of a communications bridge, from the Soyuz spacecraft, to the Kosmonaut Vladimir Komarov, to Molniya-1 satellites in Earth orbit, to the NIP-16 Flight Control Center at Yevpatoriya. The ship's first active role during a piloted mission had been on the Soyuz 4/5 docking flight, although it had provided support during the circumlunar Zond 5 mission when it had been stationed at Havana.

13 Gordon Hooper and Bert Vis. "Meeting the Space Explorers Vitali Sevastyanov" *Spaceflight News* (January 1991) 34-36

14 I. Marinin "Russia: The Extraordinary Incidents of the 'Vulkans'" (English title) *Novosti kosmonavtiki* 17 (August 12-15 1996) 22-25. Nikolayev and Sevastyanov, meanwhile, were consigned to serving as backups for the mission. The backups were A. G. Nikolayev/G. M. Grechko (Soyuz 6), A. G. Nikolayev/G. M. Grechko/P. I. Kolodin (Soyuz 7) and A. G. Nikolayev/V. I. Sevastyanov (Soyuz 8). Note that the original backup crews were different and included at various points as crew commander both A. P. Kuklin (who was dropped because of health problems in July 1969) and Ye. V. Khrunov (who was penalized in July 1969 for being involved in a hit and run automobile accident during which he had not come to the aid of the victims).

As the *Kosmonaut* Vladimir Komarov entered duty in August 1967, even larger vessels were on the drawing board—ones capable of controlling both Earth-orbital and deep space missions." All of these served to significantly expand communications-link times for piloted missions.

The architect behind much of the radio-tracking and communications equipment on these ships was Chief Designer Mikhail S. Ryazanskiy of the Scientific-Research Institute for Radio Instrument Building (formerly NII-885). One of the original members of Korolev's old Council of Chief Designers from the 1940s, he also had a very interesting career. Obsessed with building radios since he was a child, in the late 1920s, Ryazanskiy became a radio technician and a leading member of the Young Communist League at Nizhny Novgorod (or Gorkiy). It was there that he came under the suspicion of the Soviet secret police, having been accused of destroying important equipment. Incriminating evidence that his grandfather had been a priest, an "unacceptable" heritage for any Communist Party member at the time, bolstered the absurd charges. With the support of many of his coworkers, a possible death sentence was commuted to one month's hard labor. Rising through the ranks, Ryazanskiy eventually made important contributions to the Soviet wartime effort in radio and radar technology before joining the Moscow-based NII-885 as a chief designer in 1946 after the A-4 recovery operations in Germany." Along with Korolev, Glushko, Pilyugin, Barmin, and Kuznetsov, Ryazanskiy completed the original Council of Chief Designers.

Ryazanskiy's career as a chief designer was briefly interrupted in January 1951 when he was appointed the chief engineer of NII-88—a position superior to Korolev at the time. The turned tables do not seem to have disrupted their own personal relationships. Ryazanskiy was promoted out of the missile design business to an administrative position in 1952 as chief of the Seventh Chief Directorate of the Ministry of Armaments under Ustinov, but in less than two years, he returned to his chief designer spot at NII-885, saying that "administrative work is not for me." Back at the institute, life was not easy for Ryazanskiy. Secret police mastermind Lavrentiy P. Beriya had a particularly strong dislike for the chief designer because of his father's



Chief Designer Ryazanskiy was one of the ^{SIX} original members of the Council of Chief Designers. His organization, originally called NII-885, was responsible for all radio-control guidance systems for Soviet ballistic missiles and spacecraft

(files of Peter Gorin)

15 B. A. Pokrovskiy, *Kosmos nachinayetsya na zemlye* (Moscow: Patriot, 1996), pp. 347–48; *Soviet Space Programs: 1976–80 Supporting Vehicles and Launch Vehicles. Political Goals and Purposes. International Cooperation in Space Administration. Resource Burden. Future Outlook*, prepared for the Committee on Commerce, Science, and Transportation, U.S. Senate, 97th Congress, 2d sess. (Washington, DC: US Government Printing Office, December 1982), p. 127. During the Soyuz 45 mission, the *Kosmonaut Vladimir Komarov* had served in conjunction with two other old vessels, the *Morzhovets* and the *Nevel*. See G. S. Narimanov, ed., *Ot kosmicheskikh korablye - k orbitalnym stantsiyam* (Moscow: Mashinostroyeniye, 1971), p. 57.

16 Col. M. Rebrov, "The Whiteness of Martian Seas . . . Pages From the Life of the Chief Designer of Radio Control Devices" (English title), *Krasnaya zvezda*, March 11, 1989, p. 4.

17 *Ibid*

political leanings in the 1930s. Several people from NII-885 were, in fact, arrested in 1952–53 by Beriya's henchmen, while Ryazanskiy himself was charged with withholding evidence. His fate and possibly his life were saved by the deaths of Stalin and Beriya in 1953. Later, Ryazanskiy was instrumental in choosing the site of the Baykonur Cosmodrome, an action that would prompt Korolev to often grumble: "Mikhail is to blame for everything. He chose this Cod-forsaken hole. . . ."¹⁸ The final ignominy Ryazanskiy had to face was in 1961, when all the original members of the Council of Chief Designers received their second Hero of Socialist Labor award—all except Ryazanskiy. As rumor had it, Ryazanskiy had been witness to one of Brezhnev's drinking binges around 1960. When the latter had offered the chief designer a cognac, Ryazanskiy disgustingly refused his offer. Brezhnev remembered this event when the awards were handed out for Gagarin's flight. Ryazanskiy's name was crossed off of the list and substituted with that of Brezhnev. At the time of the triple Soyuz mission, Ryazanskiy was sixty years old.

Troika

The first IIA511 booster with its Soyuz payload was moved to the pad at site 31 at Tyura-Tam on the morning of October 8 to begin its prelaunch processes. It would be an intensely active period for ground personnel: over a period of three consecutive days, Strategic Missile Forces troops would launch three different Soyuz stacks into orbit. Each spacecraft would remain in orbit for five days, all three overlapping for the middle three days. News about an impending Soviet space spectacular evidently leaked out of Moscow, with some press reports, on October 9, predicting the launch of three Soyuz spaceships that might be used for "building an orbital station."¹⁹

7K-OK spacecraft no. 14 lifted off on time at 1410 hours Moscow Time on October 11, 1969, with two rookie cosmonauts Lt. Colonel Georgiy S. Shonin (the commander) and civilian Valeriy N. Kubasov (the flight engineer), both thirty-four years old at the time. The spacecraft, named *Soyuz 6*, which was not equipped with a docking probe but did carry the small Vulkan apparatus in its living compartment, entered an initial orbit of 186.2 by 222.8 kilometers inclined at 5.168 degrees. It had been almost ten months since the last Soviet piloted mission. Among the objectives announced by the Soviet media were perfecting spacecraft control systems, testing navigational devices, carrying out Earth resources photography, investigating atmospheric phenomena, performing biomedical research, and experimenting with welding in vacuum and weightlessness.²⁰ It seems that the cosmonauts did not do much during their first day in orbit apart from a main engine firing on the fourth orbit at 2008 hours to change orbital parameters. Some minor activity on the fourteenth orbit involved Shonin carrying out navigational exercises using the astro-orientation system and automatic stellar sensor. Kubasov, meanwhile, tried out a new sextant, the SMK-4, whose measurements were compared with computations on the ground to verify the accuracy of the instrument. Kubasov later took photographs of the low-lying Caspian Sea coast and the Volga delta, forests in Central Russia, and cloud formations.²¹

Mounting rumors of more Soyuz launches were confirmed the following day, when 7K-OK spacecraft no. 15 lifted off from site 1 at Tyura-Tam at 1345 hours with not two, but three rookie

18. *Ibid*

19. *Soviet Space Programs, 1966–70*, p. 377

20. G. I. Petrov, ed., *Conquest of Outer Space in the USSR, 1967–70* (New Delhi: Amerind Publishing Co., 1973), pp. 117–18.

21. Peter Smolders, *Soviets in Space* (New York: Taplinger Publishing Co., 1973), p. 179

cosmonauts. The ship, named *Soyuz 7*, entered an initial orbit of 207.4 by 225.9 kilometers at a 51.68-degree inclination to the equator. Aboard were Lt. Colonel Anatoliy V. Filipchenko (the commander), civilian Vladislav N. Volkov (the flight engineer), and Lt. Colonel Viktor V. Gorbatko (the research engineer). Filipchenko was forty-one at the time, while Volkov was thirty-three and Gorbatko was thirty-four. TASS announced the goals of the mission as including maneuvering in orbit, navigational investigations jointly with *Soyuz 6* in group flight." and scientific research consisting of the observation of celestial bodies and Earth's horizon, the determination of the actual brightness of stars, and measurements of illumination by the Sun." Naturally, there was no mention that the ship was equipped with a passive docking mechanism, nor that the spacecraft was to dock with a third *Soyuz*.

Preparations for the launch of 7K-OK spacecraft no. 16 had begun immediately after the launch of *Soyuz 6* from the pad at site 31. Within two hours of launch, the new booster-payload stack was moved to the pad to begin its prelaunch operations. Once the two cosmonauts were settled into the descent apparatus of the spacecraft, Commander Shatalov ran into a minor problem while tightening the wheel on the hatch lock between the two *Soyuz* modules when one of its three spokes cracked under excess pressure. The crew reluctantly reported the problem to ground control, who advised that as long as pressure integrity was maintained, the problem would not hinder a timely launch." Thus, within twenty-four hours of the launch of *Soyuz 7*. Strategic Missile Forces personnel launched the third *Soyuz* spacecraft in three days. The launch was at 1319 hours Moscow Time on October 13, 1969. Veteran cosmonauts Colonel Vladimir A. Shatalov (the commander), who was forty-one, and civilian Aleksey S. Yeliseyev (the flight engineer), who was thirty-five, entered an initial orbit of 204.5 by 223.7 kilometers at a 51.68-degree inclination. TASS announced that the new ship, named *Soyuz 8*, would carry out complex scientific observations with *Soyuz 6* and *Soyuz 7*, including group flight and the even more general "joint orbital maneuvering to solve a number of problems connected with manned space flights."²⁴ TASS also reported that Shatalov would be in overall command of the three ships. Both he and Yeliseyev had the distinction of holding the record for the shortest turnaround for space missions, having flown in space less than ten months earlier.

Initially, after *Soyuz 8* entered orbit, the three spacecraft carried out independent flight focused on their own experiments program, although several orbital corrections by all three ships on October 13 and 14 seemed to have been preliminary maneuvers to allow for the eventual intersection of their orbits. In general, the experiments program in orbit was divided up. The *Soyuz 6* crew carried out biomedical research (such as inner ear tests) and Earth photography. The *Soyuz 7* crew performed photography of Earth and stellar objects in differing spectral bands. The *Soyuz 8* crew focused on research on the polarization of sunlight reflected by the atmosphere. Biomedical experiments included using "functional probes" and individual and group psychological tests to assess working capacity in orbit. Earth photography focused on the development of cyclones and the movement of storm fronts. The *Soyuz 7* cosmonauts, in particular, conducted detailed remote-sensing exercises, including the study of geological areas to detect reserves of mineral raw materials. *Soyuz 8* Flight Engineer Yeliseyev, like his compatriot Kubasov on *Soyuz 6*, also used a new SMK-4 sextant to determine orbital elements independently of help from ground stations. One major experiment involved the determination of reflective properties of forests, deserts, and other areas of Earth's surface. The crews remained in regular contact with each other and for the first time jointly used the Molniya-1 satellite

22 Petrov *Conquest of Outer Space* p 123

23 M F Rebrov *Kosmicheskiye katastrofy Russkiye sensatsii* (Moscow Izdat, 1993) pp 43-44

24 Petrov *Conquest of Outer Space* p 129



Here are the seven cosmonauts of the Soyuz 6/7/8 mission. Sitting from left to right are Valeriy Kubasov, Georgiy Shonin, Vladimir Shatalov, and Aleksey Yeliseyev. Standing from left to right are Viktor Gorbatko, Anatoliy Filipchenko, and Vladislav Volkov. (files of Peter Gorin)

system and the *Kosmonaut Vladimir Komarov*.²⁵ A military component of the Soyuz 6 mission was the *Fakel* ("Torch") experiment for visually detecting the launch plumes of ballistic missiles from orbit.²⁶ Evidently using the *Svinets* apparatus, Shonin later reported that he could clearly see special light projectors on ground targets and that the measurement of background illumination was not difficult. On three occasions on October 12, R-16 ICBMs were launched from Tyura-Tam while Soyuz 6 passed over the launch range. All the launches were at night, limiting the applicability of the experiment. It is unlikely that the *Svinets* instrument would have been capable of detecting launches during daytime.

25. Older ships, such as the *Bezhtsa*, *Borovichr*, *Dolinsk*, *Kegostrov*, *Morrhovets*, *Nevel*, and *Ristna*, were also used for communications. See Evgeny Riabchikov, *Russians in Space* (Moscow: Novosti Press Publishing House, 1971), p. 273. For the general experiments program, see Smolders, *Soviets in Space*, pp. 181, 184; Riabchikov, *Russians in Space*, pp. 273-74; Kenneth Gatland, *Manned Spacecraft* (New York: Macmillan, 1976), pp. 143-45; Lardier, *L'Astronautique Soviétique*, p. 188; Narimanov, *Ot kosmicheskikh korably*, p. 72.

26. "In Memory of Cosmonaut C. S. Shonin" (English title), *Novosti kosmonautiki* 7 (March 24-April 6, 1997): 25-27.

By October 14, the three spacecraft were in a common orbit of roughly 200 by 225 kilometers at a 51.7-degree inclination. As planned, the Soyuz 7 and Soyuz 8 spacecraft approached each other to within a distance of 500 meters, while Soyuz 6 watched nearby. Docking between Soyuz 7 and Soyuz 8 had been planned to be semi-automatic, with the Igla system bringing the two ships to a distance of 100 meters of each other, after which Shatalov would take over manual control. As backup cosmonaut Sevastyanov recalled later, the ships did not come closer than 500 meters of each other:

There was a mistake during the preliminary stage of the docking and the [Igla] radio system didn't work [on Soyuz 8]—it didn't give the information on where the second spacecraft was. They tried to use an optical channel, but at that time they didn't have a special laser device for measuring the distance, and they had no possibility to measure the distance between the two spacecraft."

The "optical channels" were evidently bright light signals on the ships used at range distances of 1,500 meters and 500 meters. In two attempts to close in on Soyuz 7 manually from those distances, an increasingly stressed Shatalov on Soyuz 8 found it too difficult to measure the relative distance to the passive spacecraft while the ships were in Earth's shadow. The cosmonauts' frustrations were exacerbated by on-board indicators showing that the Igla system was completely operational. Recent reports indicate that one or more of the ships may also have been inserted into the wrong orbit, further complicating matters.²⁸ Because of the malfunctioning Igla system, the Soyuz 8 cosmonauts were unable to move close enough to Soyuz 7 to transfer to manual control and dock. As a last desperate move, ground control decided to try and maintain station-keeping between the two ships using only ballistics data transmitted from the ground. The docking attempt was rescheduled for the following day, October 15. Unfortunately, without the use of the Igla system, the cosmonauts were unable to bring the ships closer than 1,700 meters. The third ship, Soyuz 6, which did not carry the Igla system, was unable to independently complete any close approaches to the other two spacecraft.

That the mission was a complete mess was underlined in a U.S. intelligence report, which was declassified in 1997. The CIA wrote:

The five rendezvous attempts made during the mission were all unsuccessful for several different reasons. The first failed because the automatic rendezvous system [that is, Igla] would not indicate radar lock-on between Soyuz 7 and 8. Two orbits later the first manual rendezvous attempt was made but it was broken off after Soyuz 8 used more than the authorized amount of attitude-control propellant. A second manual attempt, made the next day, failed because Soyuz 8 did not properly control its lateral velocity relative to Soyuz 7. The attempt by Soyuz 6 to carry out a cosmonaut-controlled rendezvous with the other two spacecraft failed because of insufficient time to correct for a three kilometer out-of-plane separation between it and the other vehicles. The final manual attempt at rendezvous and docking between Soyuz 7 and 8 was poorly timed and the vehicles could not establish the correct interval and relative velocity between them required for a docking operation before they entered the earth's shadow.."

27 Hooper and Vis "Meeting the Space Explorers Vitali Sevastyanov" p 36

28 "In Memory of Cosmonaut G S Shonin "

29 U.S. Central Intelligence Agency "National Intelligence Estimate 11-171 The Soviet Space Program " Washington DC July 1 1971 p 29 as declassified in 1997 by the CIA Historical Review Program

According to official Soviet data, during three days of jointly coordinated flight, the ships completed thirty-one orbital maneuvers. Using Soyuz 7 as a target vehicle, Soyuz 6 and Soyuz 8 completed three and four close rendezvous, respectively. On two occasions, the approaches were simultaneous—that is, all three vehicles were in very close proximity for a total of four hours and twenty-four minutes of "co-orbiting." Soyuz 7 and Soyuz 8, meanwhile, spent as much as thirty-four hours and nineteen minutes "co-orbiting" with each other." During these rendezvous exercises:

The crews made observations of the other spaceships, took photographs, and used movie cameras to determine the visibility of objects at various distances. They also investigated the possibility of exchanging information by means of light indexes and visual optical devices.³¹

The exchanging of information was probably related to military experiments. A former CIA official later recounted that:

The cosmonauts experimented with methods of communicating with each other and used light sources that could not be monitored by normal electronic intelligence listening devices. They also conducted experiments to determine the visibility of objects at various distances from their spaceships, which among other things is the type of information used by military planners for designing equipment for photographing and inspecting hostile satellites."

No pictures taken during the mission have ever been published by the Soviet or Russian press in the thirty years since the mission. With the disappointments of the several failures behind them, Chief Designer Mishin had the unfortunate task of telephoning both Brezhnev and Ustinov to inform them of the situation.

It was on October 16 that cosmonauts Shonin and Kubasov on Soyuz 6 prepared for one of the main goals of the entire experiment, the welding exercise with the Vulkan unit. The instrument itself was a squat green cylinder resembling "a round refrigerator" with a mass of about fifty kilograms, installed in the living compartment of Soyuz 6. The object consisted of two sections, one of which contained various instruments and power sources, measuring and converter devices, and communications and automation equipment in a pressurized nitrogen atmosphere. The other section contained the welding devices. Scientists at the Paton Institute had painstakingly designed the unit based on extensive tests in vacuum chambers and on parabolic weightless flights in aircraft. On their seventy-seventh orbit, the Soyuz-6 cosmonauts shut the hatch between the descent apparatus and the living compartment and depressurized the latter module. Flight Engineer Kubasov, using remote-control switches, then turned on the welding unit, initiating three different methods. The system first performed a low-pressure compressed arc welding. This was followed by an attempt at electron beam welding. The final method was arc welding using a consumable electrode. The actual welding was performed using an electron gun with samples of titanium, aluminum alloys, and stainless steel. All the welding was automated, and the only major role of the crew was to turn on the system and recover the samples. Kubasov was, however, able to follow the work of the unit with a special

30 Lardier, *L'Astronautique Soviétique*, p. 188

31 Riabchikov, *Russians in Space*, p. 273

32 Peter N. James, *Soviet Conquest From Space* (New Rochelle, NY: Arlington House Publishers, 1974), p. 116.

indicator panel in the descent apparatus, while data were also directly transmitted to ground stations." Academician Paton later glowingly reported that:

The experiment in welding in orbit had opened a new page in the exploration of space. An engineering procedure involving the heating and melting of metal has been performed in space for the first time. The age of space metallurgy has dawned.³⁴

While much was made of the fact that welding would be a requisite for future orbital assembly operations in space, the Vulkan experiment was, in fact, a near catastrophe for the Soyuz 6 crew. Soviet authorities revealed twenty-one years later that "the welding experiment which was supposed to be carried out on one of the ships, ended unsuccessfully. They almost burned a hole in the ship." "During one of the three methods tested, possibly the low-pressure compressed arc, the Vulkan unit evidently incorrectly aimed a beam and melted the internal wall of the living compartment. The cosmonauts were apparently unaware of the danger during the experiment, and they only discovered the damage once the living compartment was repressurized to recover the samples of the experiment."

Soyuz 6 returned to Earth almost as soon as the Vulkan exercise was over. The two cosmonauts landed at 1252 hours Moscow Time on October 16, 1969, in the frozen and barren steppes of Kazakhstan. 180 kilometers northwest of the town of Karaganda. Their mission had lasted four days, twenty-two hours, forty-two minutes, and forty-seven seconds. It was chilly cold with a powerful wind at the landing site, and despite landing twenty kilometers from the intended landing point, rescue services were able to reach the cosmonauts relatively quickly.

The Soyuz 7 and Soyuz 8 cosmonauts continued their missions in Earth orbit. The remainder of the mission was uneventful except for a malfunction on Soyuz 7 on October 17. One of three cosmonauts accidentally activated the automatic landing system display in the descent apparatus. The unit was supposed to turn on automatically at an altitude of eleven kilometers after reentry for use during the parachute descent. Because the display was to be used on the last leg of the mission, there was no provision to turn it off in orbit. Some ground controllers were concerned that if the display remained continuously turned on for more than a day, there might be a possibility of failure during descent." With little to do to rectify the situation, the crew continued to orbit Earth with the system left active. The Soyuz 7 and Soyuz 8 crews carried out the perfunctory medical experiments and Earth photography exercises during the remainder of their missions before preparing to return to Earth. Soyuz 7 cosmonauts Volkov and Gorbatko, in particular, carried out complex spectrophotometry and photography of the twilight aureole of Earth, its clouds, and its underlying surface using the handheld RSS2 spectrograph. The experiment was carried out on the spacecraft's eighty-seventh orbit over northeast Africa from an altitude of 218 kilometers. An earlier session on October 13 over the Arabian penin-

33 *Soviet Space Programs 1966-70* p 237 Lardier *L'Astronautique Soviétique* p 188 Gatland *Manned Spacecraft* p 143 Riabchikov *Russians in Space* p 274 Narimanov *Ot kosmicheskikh korably* p 73

34 Riabchikov *Russians in Space* pp 274-75

35 German Nazarov "You Cannot Paper Space With Rubles How to Save Billions" (English title) *Molodaya gvardiya* no 4 (April 1990) 192-207

36 The inference that it was the low pressure compressed arc that caused the problem is based on the premise that the Soviets at the time touted the success of the other two methods but refrained from doing so for the compressed arc test See Gatland *Manned Spacecraft* pp 143-45 for positive evaluations of arc welding and see *Soviet Space Programs 1966-70* p 237 for the same for electron beam welding See also 'In Memory of Cosmonaut G. S. Shonin'

37 I. N. Kamanin 'Removing the Cosmetic Retouching: N. Kamanin—From His Journal Entries for 1970' (English title) *Sovetskaya kultura* July 14 1990 p 15

sula was coordinated with ground observatories and two specially equipped Li-2 scientific aircraft flying at altitudes of 2.7 kilometers.³⁸

The three-cosmonaut Soyuz 7 crew returned to Earth without incident, landing safely 155 kilometers northwest of Karaganda at 1226 hours Moscow Time on October 17, 1969, almost exactly a day after Soyuz 6. Their mission had lasted four days, twenty-two hours, forty minutes, and twenty-three seconds. The weather was worse this time, with stinging cold winds of snow and sleet as well as low visibility. Soyuz 8 crewmembers Shatalov and Yeliseyev settled down a day later at 1210 hours Moscow Time on October 18, 145 kilometers north of Karaganda in a raging blizzard. The last crew had completed a mission lasting four days, twenty-two hours, fifty minutes, and forty-nine seconds. The triple Soyuz flight was over.

As much as the flight bewildered Western observers with its meandering nature and lack of docking, Soviet spokespersons went on the offensive after all three ships had touched down. They had had little to celebrate during the year, and the modest achievements of Soyuz 6, Soyuz 7, and Soyuz 8 would have to do. The cosmonauts' return to Moscow was made into a celebratory event of national proportions. As bands played and salutary guns fired, Communist Party and government leaders and thousands of Muscovites welcomed the seven men. At the ceremonial reception at the Kremlin Palace of Congresses, all the cosmonauts were awarded, like their predecessors, the title "Hero of the Soviet Union."³⁹ This occurred, despite the obvious failure to achieve the primary goal of the mission—the docking between Soyuz 7 and Soyuz 8—which was, of course, not announced as such. All Soviet press reports of the time clearly put forward the notion that docking had not been planned for the flight. As for the failure, the cosmonauts were exonerated of any wrongdoing during the mission. A thorough investigation that took three months proved that the failure in the Igla system had been caused by errors in ground preparations. When the Scientific-Research Institute for Precision Instruments had tested Igla on the ground for pressurization, engineers had used a 95-percent helium mixture. Investigators later discovered that this particular mixture harmed the radio components and thermostats of the flight units. After two more instruments from the same institute had failed in orbit by the end of 1969, engineers changed the mixture to either inert gases or a 5-percent helium solution.⁴⁰

The postflight period for the triple Soyuz mission was particularly important because of the insistent and precise nature of Soviet statements on orbital stations. It finally seemed that the apparent confusion of the earlier part of the year on future prospects for the Soviet space program was finally over. Academician Sedov, the man who had made the infamous announcement on the launch of a Soviet satellite during the International Geophysical Year in 1955, told reporters in Peru in late October 1969 that the Soviet Union had never announced that it would send men to the Moon." Fortunately for Sedov, no one bothered to read to him his pronouncements on the topic from earlier in the decade. Perhaps the most important public policy statement by a top Soviet figure emerged amid the celebrations for the Soyuz 6/7/8 mission. In a speech on October 22 at the Kremlin Palace of Congresses that retrospectively proved to be as important for the Soviet space program as Kennedy's speech in 1961 was for the United States, First Secretary of the Central Committee of the Communist Party Leonid I. Brezhnev made no bones about the "true direction" for the future Soviet cosmonaut:

38 K Ya Kondratyev, A. A Buznikov, B. V Vinogradov, V. N Volkov, V. V Corbatko, and O I. Snotky, "Spectrophotometry of the Earth From Manned Spacecraft," in K Ya Kondratyev, M J. Rycroft, and C Sagan, eds., *Cospar Space Research XI Volume 1* (Berlin: Akademie-Verlag, 1971), pp 619-32.

39. Riabchikov, *Russians in Space*, p 276.

40. Yu. A. Mozzhorin, *et al.*, eds., *Dorogi v kosmos: II* (Moscow: MAI, 1992), pp. 35-36.

41 *Soviet Space Programs, 1966-70*, p. 378.

Our country has an extensive space program, drawn up for many years. We are going our own way: we are moving consistently and purposefully. *Soviet cosmonautics is solving problems of increasing complexity. . . . Our way to the conquest of space is the way of solving vital, fundamental tasks, basic problems of science and technology. . . . Our science has approached the creation of long-term orbital stations and laboratories as the decisive means to an extensive conquest of space. Soviet science regards the creation of orbital stations with changeable crews as the main road for man into space. They can become cosmodromes in space, launching platforms for flights to other planets. Major scientific laboratories can be created for the study of space technology, biology, medicine, geophysics, astronomy, and astrophysics.*⁴²

He added a second thread—that of a Soviet space program working purely for improving the welfare of Soviet citizens: "Space for the good of people, space for the good of science, space for the good of the national economy. Such in brief, is the substance of the Soviet space program—its philosophical credo." The implication was clear: while Americans were chasing the Moon with Apollo, an empty, politically motivated enterprise, Soviet cosmonauts were doing their all for the advancement of science and ultimately for the benefit of humankind. From the moment Brezhnev finished his speech, it was clear to most participants in the Soviet space program that the age of the space station had begun—an era that ultimately led to the Mir space station.

At a postflight press conference for the Soyuz 6/7/8 mission on November 4, Academy of Sciences President Keldysh stressed that Soviet efforts in space would focus on the creation of the first permanent orbital space station. The timeframe would "certainly be within ten years, and [probably] less than five years . . . literally in the nearest future." On October 24, Keldysh told the Swedish press that "we no longer have any scheduled plans for manned lunar flights." Commentators through the end of the year also repeatedly stressed the importance of cost in future planning, suggesting that automatic exploration of the Moon was far cheaper than piloted exploration. The suggestion was that the high cost of space exploration had forced a redirection in the overall effort.⁴³ All this worked to neutralize the success of Apollo. In one of the more bold pronouncements of the period, The New York *Times* claimed in a page-one story in late 1969 that.

according to some observers in Washington and some American scientists, the Russians may never *have* had a high-priority goal and timetable for a lunar landing in the same sense as the Apollo project's commitment to land men on the Moon in this decade."

42 This excerpt from his speech is a slightly modified version of that published in *ibid* p 378. Some corrections have been added based on the excerpts in James F. Clarity 'Brezhnev Says Soviet is Following the Main Road in Space' *New York Times* October 23 1969 p 20

43 Riabchikov *Russians in Space* p 278

44 Bernard Cwertzman 'Soviet Expert Predicts Space Station in 5 Years' *New York Times* November 5 1969 p 16 There was an amusing exchange at the press conference that was not reported in the West. Upon being asked by a U.S. reporter whether the Soviets were preparing to send a man to the Moon, Keldysh replied confusingly "I think the Moon has to be sent to the man." The audience burst into laughter, but it took Keldysh a long time to realize why the audience was laughing. It was only when Shatalov prompted him that the academician tried to correct himself, but he did it so clumsily that there was more laughter. See Kamanin 'I Feel Sorry for Our Guys' no 14

45 John Noble Wilford 'Soviet Apparently Drops Plan to Put Men on Moon' *New York Times* October 26 1969 pp 1-11

46 See for example Bernard Cwertzman 'Soviet Curbs Space Work for Economy' *New York Times* December 31 1969

47 Wilford 'Soviet Apparently Drops Plan to Put Men on Moon' p 1

From an outside perspective, the direction of the Soviet space program seemed simple. While the Soviets may have been looking to compete with Apollo in the early 1960s, they abandoned that goal early, perhaps around 1964-65, and had then focused only on the development of an Earth-orbital space station. For almost twenty years, this would indeed be the dominant paradigm in understanding Soviet motives during the 1960s and 1970s.⁴⁸

If Westerners proved to be easier to convince of Soviet intentions, the USSR's own citizens proved less gullible. A Moscow-based journalist, recalling the Brezhnev speech, wrote with sarcasm in 1990:

Orbital stations at that time did not represent an end itself, but a political response. Following the spectacular lunar landing by Neil Armstrong and Edwin Aldrin in July 1969, Brezhnev was obliged to come up with an alternative space project to save face, as *well* as the badly tarnished myth of Soviet superiority in space. He was told about an alternative. Brezhnev mentioned the U.S. success in reaching the moon and said that "we are following a different course, which is consistent and purposeful." Designers, cosmonauts, and thousands of other people probably laughed up their sleeves, knowing full well that the General Secretary was *lying*.⁴⁹



USSR Academy of Sciences President Mstislav Keldysh's scientific managerial and advisory contributions to the Soviet space program were matched by only a few individuals during the Soviet era. Keldysh also had the distinction of being one of the few high ranking individuals in the space program whose identity was public knowledge (files of Peter Gorin)

Brezhnev's pronouncements notwithstanding, in reassessing the trajectory of the Soviet piloted space program in 1969, a few questions come to mind. Did the Soviets really abandon their piloted lunar program in 1969? In other words, was the space station option put forward as a substitute or a complement to the lunar program? Why space stations? As with most policy issues in the Soviet space program, the answers to these questions are not simple, nor can they be isolated from the myriad of programs and proposals dating from the Korolev era.

The Space Station Arrives

By the late spring of 1969, Soviet space officials had already decided on three options available for a suitable response to Apollo, prompted by the stunning success of Apollo 8 in December 1968. These options were a piloted mission to Mars, the modification of the NI-L3

48. See, for example, Nicholas Daniloff, *The Kremlin and the Cosmos* (New York: Alfred A. Knopf, 1972), pp. 153, 164; William H. Schauer, *The Politics of Space: A Comparison of the Soviet and American Space Programs* (New York: Holmes and Meier, 1976), pp. 164-78.

49. Leonard Nikishin, "Inside the Moon Race," *Moscow News*, April 11, 1990, p. 15.

program for extended visits to the Moon, and the creation of Earth-orbital stations. Although Brezhnev's speech served to move the third option into the forefront, the Soviet space establishment did not give up the other two options in late 1969. In fact, if funding was any indication, money for the N I-L3 piloted lunar program reached a peak in appropriations for 1970, about \$1.8 billion, a year after Apollo 11.⁵⁰ While there was certainly a state commitment for the lunar landing program well past 1969, as well as a modicum of interest in the Mars project, the space station program seems to have offered the quickest return. Ustinov, Smirnov, and Afanasyev needed something big, perhaps as early as 1970. Neither the N I-L3 nor any proposed Mars expedition would be ready by then. Space stations were seen as an acceptable alternative.

As with most Soviet space projects of the period, there was another external factor. The U.S. Department of Defense had forged ahead with the Manned Orbiting Laboratory for the latter part of the 1960s, but that program had been canceled in May 1969. On the civilian side, NASA had been studying space station options almost since its birth in 1958, and in 1965 these studies evolved into the Apollo Applications Program—a project that would make maximal use of Apollo hardware to build a modest space station in Earth's orbit. In July 1969, NASA selected a final design for the project, a "dry workshop" based on an upper stage of the Saturn V booster. A month later, the space agency "definitized" a contract with McDonnell Douglas to build the station, renamed Skylab in February 1970." The station was expected to be ready for launch by mid-1972. Afraid of losing another race in space, Ustinov did not want to react with too little too late."

In some ways, the space station option was one hoisted upon Soviet space engineers. Many in the upper echelons of the Soviet space industry, having invested almost ten years on the N I-L3 lunar program, were reluctant to see it consigned to second place behind some hastily put together space station program. TsKBEM Deputy Department Chief and veteran cosmonaut Feoktistov hinted later at the discord brewing within the design bureau.

In the 1960s it was clear to us engineers that the most important development for manned flights would be the creation of orbital space stations, but the administration was against it. Mishin, the Design Bureau Chief, was totally opposed to this. He thought that it was important to carry on with the Moon program. Everything else was nonsense and not worth doing."

The debate over the space station versus the Moon program split the design bureau into opposing factions, and in a few years, this small fracture in unity would ultimately lead to cataclysmic consequences. But even as early as 1969, the "pro space station" group had powerful supporters in highly placed positions and managed to pull the right strings. Feoktistov later described how his faction managed to influence the content of Brezhnev's famous October 1969 speech:

50 V P Mishin 'Why Didn't We Fly to the Moon?' (English title) *Znaniye tekhnike seriya kosmonavti ka astronomiya* no 12 (December 1990) 3-43 The amount in Soviet currency, according to Mishin was 600 million rubles. The total appropriations for the N I-L3 program up to January 1 1971 was 2.9 billion rubles or roughly \$8.7 billion.

51 Linda Neuman Ezell NASA *Historical Data Book Volume III Programs and Projects 1969-1978* (Washington DC NASA Special Publication (SP) 4012 1988) pp 98-100 Roger D Launius NASA *A History of the U.S. Civil Space Program* (Malabar FL Krieger Publishing Co 1994) pp 97-98

52 The Skylab option as a rationale for the Soviet space station program is mentioned in Semenov ed *Raketno Kosmicheskaya Korporatsiya* p 264

53 'The Russian Right Stuff' *The Dark Side of the Moon* NOVA television show #1808 WGBH TV Boston February 27 1991

We didn't know how to get the bosses to change their minds, but some well-wishers in the Party Central Committee cunningly inserted a passage into *Brezhnev's* speech saying that orbital stations promised the right way forward.⁵⁴

While the identity of the "well-wishers" remain undisclosed, one of them was probably Dmitriy F. Ustinov, who, unhappy about the results of the lunar program, apparently wanted some immediate results from an aimless space program." He also had his own reputation to protect. As the secretary of the Central Committee for Defense Industries and Space, he was directly responsible for the Soviet space program. When his boss Brezhnev announced the space station as the "main road into space," it cemented the pro space station faction's position. The NI-L3 program would, of course, continue, as would work on a Mars project, but results from the new option were expected in 1970 or 1971.

Since the early 1960s, the late Korolev had tasked engineers at his design bureau to explore the possibility of designing what was generically called the Heavy Orbital Station (TOS). Reportedly nicknamed *Zvezda*, work on the proposal continued throughout the 1960s with neither official sanction nor much financial support.⁵⁶ Diverted by more pressing programs such as Soyuz and eventually the NI-L3 effort, it seems that Korolev had viewed the idea as one left for fruition during the 1970s.

A special subdivision of the Korolev design bureau studied several different variants of the TOS during the 1960s, from relatively small designs to giant space stations. One small space station design consisted of three floors: the living quarters, a controlling compartment, and an airlock chamber. One end of the station had a multiple docking adapter for four visiting Soyuz-type spacecraft. In this variant, the TOS was six meters in length, just under three meters in diameter, and cylindrical in shape, with the floors akin to "slices" along the longitudinal axis. A mock-up of the station was built in assembly shop no. 444 at the Experimental Machine Building Plant at Kaliningrad, the very same site where workers assembled Soyuz ships.⁵⁷ Another similar conception, also apparently built, had four floors. The floors were for lockers and "cupboards," for a crew compartment with a kitchen and toilets, for a laboratory and a control post, and for a multiple docking unit for five visiting spacecraft. The docking unit would also serve as an airlock adapter for performing EVAs.⁵⁸ By 1969, as space stations began to assume a more crucial role in the future of the Soviet space program, a group at TsKBEM began work on a much more ambitious version of the TOS, a 100-ton behemoth to be launched into Earth orbit by the NI rocket. The station proper was a cylinder twenty meters long and six meters in diameter. Four Soyuz spacecraft could dock at a special multiple docking section at one end of the station, each node angled at thirty degrees to the main axis of the vehicle, giving the entire station the look of an arrow with feathers." None of the TOS conceptions went beyond exploratory studies. As one Soviet space historian later recalled. "Korolev assumed that he would be able to realize [the] notion of a manned station, but he was so overloaded with other work, he wasn't able to do it."

54. Ibid.

55. Kamanin suggests that it was Ustinov, Smirnov, and Keldysh who were instrumental in "putting these words into [Brezhnev's] mouth." See Kamanin, "I Feel Sorry for Our Guys," no. 14.

56. The designation *Zvezda* is from Yaroslav Golovanov, *Korolev fakty i mify* (Moscow: Nauka, 1994), p. 768.

57. V. M. Petrakov, "Soviet Orbital Stations," *Journal of the British Interplanetary Society* 47 (September 1994): 363-72.

58. C. Wachtel, "The Chief Designers of the Soviet Space Program," *Journal of the British Interplanetary Society* 38 (December 1985): 561-63.

59. Semenov, ed., *Raketno-Kosmicheskaya Korporatsiya*, p. 278.

60. I. B. Afanasyev, "Unknown Spacecraft (From the History of the Soviet Space Program)" (English title), *Nouoye v zhizni: Nauke, tekhnike. Seriya kosmonavtika, astronomiya* no. 12 (December 1991): 1-64.

The 100-ton variant of the TOS, dating from 1969, may have been a part of a much larger conceptual design that had slowly evolved at TsKBEM throughout the late 1960s. Around 1965, Korolev had approved exploratory studies of an integrated large modular space station in Earth orbit, very much similar to the ideas of Tsiolkovskiy and Oberth from the early part of the century. Designated the Multirole Space Base-Station (MKBS), it would be part of the larger Multirole Orbital Complex (MOK). Korolev had evidently entrusted this early work on the MOK to First Deputy Mishin, who continued to pursue the topic once he had become chief designer after Korolev's death." Work on the MKBS involved not only the main design bureau, but also TsKBEM's branch at Kuybyshev under First Deputy Chief Designer Kozlov. Discussions during the post-Apollo 8 period had focused on the MOKIMKBS as a possible vehicle for responding to the success of Apollo. Some officials at the time suggested integrating defense goals into the effort, perhaps to elicit some interest from the Ministry of Defense to fund the endeavor. In early August 1969, soon after the Apollo 11 mission, Ustinov had expressly ordered Mishin to accelerate work on the MKBS.

While the MOKIMKBS was an attractive long-term option, it suffered from the same limitations in time as piloted Mars missions and an expanded lunar landing project: the earliest possible flight would not be until the mid-1970s at best. Keeping the MOKIMKBS as a future proposition, Ustinov instead turned his attention to existing hardware to bring his space station idea to a realistic conclusion. At the end of 1969, the Soviets had two modest space station programs in progress, although neither had any actual hardware to fly in space. Both were primarily military in nature, and they were products of two different design bureaus. The smaller of the two was TsKBEM's Soyuz-VI station, consisting of the OB-VI block, which was about the size of a Soyuz spacecraft, and a ferry vehicle, the 7K-S, a variant of the basic 7K-OK Soyuz modified for internal crew transfer into the OB-VI block. Under Deputy Chief Designer Okhapkin's control, the design bureau had already issued the complete design documentation for facilitating a program of experimental work on the station." Early plans to launch the Soyuz-VI in 1969, however, proved to be too optimistic. Given Mishin's lukewarm support for creating the OB-VI, it was not surprising that delivery dates for flight-ready articles had been pushed back into 1970. Mishin was much more supportive of the 7K-S Soyuz ferry, arguing at many meetings in 1969 that the Ministry of Defense increase funding support for the project. Touted as an improved and more reliable version of the trouble-prone Soyuz, he believed that it was important that the 7K-S be introduced into service as quickly as possible.

Going through the list of options, Ustinov was not particularly enthused by the Soyuz-VI as an appropriate response to Apollo. What the Soviet image needed was something more substantial, something more "thick." And Ustinov found his "thick" solution not in Mishin's hands, but in the empire of General Designer Vladimir N. Chelomey. Since about 1966, Chelomey's TsKBM had been engaged in the development of the Almaz space station complex, aiming provisionally to launch the first completed product into orbit by the 100th birthday of V. I. Lenin on April 22, 1970." For the most part, progress on the project had been steady. By late 1969, work on the actual hull of the station and certain service systems was on schedule, although there were major delays in some of the internal instrumentation. As of 1970, Chelomey's engineers had built the hulls of eight test stand units and two flightworthy vehicles. At the same time, ground testing of the control system, solar panels, and some of the

61 The MKBS and the MOK were mentioned at a meeting in late 1965 to discuss changes in the 1966-70 five year plan for space exploration. See V. Denisov, "The Last Lesson" (English title) *Aviatsiya i kosmonautika* no. 12 (December 1991) 40-43. Korolev prepared notes on a tactical-technical requirement for the MKBS on September 30, 1963.

62 Semenov ed. *Raketno Kosmicheskaya Korporatsiya* p. 211.

63 Lardier *L'Astronautique Soviétique* p. 189.

station's other components was under way.⁶⁴ A small group of cosmonauts had been training for the Almaz program from as early as December 1967, and by 1969, four crews had been formed for the first flights to the station, headed by veteran commanders Belyayev, Popovich, Volynov, and Gorbatko.⁶⁵ Even more impressive, taking a page from Mishin's book, Chelomey had dozens of civilian engineers from his organization screened for cosmonaut training. Three of those passed tests and began further training in 1969 in anticipation of the formal selection process by the State Interdepartmental Commission, the body with the final word on selecting cosmonauts in the Soviet Union.⁶⁶

The Almaz option was ideal for Ustinov's push to get a space station into orbit as soon as possible—ideal except for two major problems. First, there was the lag in developing and testing the Almaz's "auxiliary" systems, such as control and guidance systems, power supplies, and so forth. There were conflicts with the military in sharing instrumentation on the station, which also contributed to delays in configuring and delivering on-board systems. Chelomey was trying his best, but he expected the problems with the systems to put a wrench in the works and delay a launch to early 1972 or late 1971 at best.⁶⁷ Second, Ustinov despised Chelomey. Having opposed Chelomey's plans at critical junctures throughout the 1960s, it would put Ustinov in an awkward position if, of all people, it was Chelomey who would chalk up a victory for the Soviet space program.

In late 1969, Ustinov began wholeheartedly supporting an unthinkable, but typically brilliant solution: why not have Mishin's design bureau use one of the almost-finished Almaz units, complete it with instrumentation from the Soyuz, and then launch it into space, all within one year?⁶⁸ There is still some confusion on the source of this idea. Some attribute it to Ustinov and some to a group of Mishin's subordinates at his design bureau. One common story is that three leading deputy chief designers at TsKBEM—Bushuyev, Chertok, and Okhapkin—in alliance with three important department chiefs—Feoktistov, Kryukov, and Raushenbakh—approached Ustinov with a proposal to use elements of the Almaz orbital station re-equipped with the auxiliary systems that had already been tested in orbit on the Soyuz spacecraft. In addition, they would build a delivery vehicle, a modified Soyuz named the 7K-T, specifically to serve as a ferry to and from the station. According to Bushuyev and the others, a preliminary analysis had evidently showed that the idea was not only feasible but could be fulfilled in the shortest time.⁶⁹ According to one source, Mishin, who wanted to maintain the NI-L3 lunar program as the primary focus of his organization, was bypassed in these initial discussions in late 1969, being on holiday at Kislovodsk at the time. Possibly, this was not a coincidence, and Mishin's deputies may have taken advantage of the chief designer's absence to solidify the

64. Afanasyev. "Unknown Spacecraft": Vladimir Polyachenko. "The 'Pep' of Almaz" (English title). *Krylya rodiny* no. 1 (January 1992): 18–19.

65. Polyachenko. "The 'Pep' of Almaz." Another source suggests that there were three commanders in 1969: P. R. Popovich, V. D. Shcheglov, and O. A. Yakovlev. See E-mail correspondence, Sergey Voevodin to the author, January 30, 1997.

66. The three candidates from TsKBEM were A. A. Grechanik, V. G. Makrushin, and D. A. Yuyukov. See Nina Chugunova. "Chelomey's Cosmonauts: Why There Are No Crews From NPO Mashinostroyeniya in Outer Space" (English title). *Ogonek* 4–5 (January 1993): 24–29.

67. Petrakov. "Soviet Orbital Stations": Chugunova. "Chelomey's Cosmonauts". Semenov ed. *Raketno-Kosmicheskaya Korporatsiya*, p. 264.

68. Dmitriy Payson. "Without the 'Secret' Stamp: 'Salyut' and Star Wars" (English title). *Rossiyskiye vesti*, November 21, 1992, p. 4.

69. Semenov ed. *Raketno-Kosmicheskaya Korporatsiya*, p. 264. In one source, the idea for using the Almaz as a basis for the new station is attributed to Mishin himself, but given later events, this is extremely unlikely. See S. A. Zhiltsov, ed. *Gosudarstvennyy kosmicheskyy nauchno-proizvodstvennyy tsentr imeni M. V. Khrunicheva* (Moscow: RUSSLIT, 1997), p. 74.

"pro space station" contingent within the design bureau. Ustinov was clearly supportive of the idea, not the least because it would be a big blow to Chelomey's indefatigable ambitions. As the ball started rolling on the idea, Chelomey was acutely aware that it was Ustinov who was the main sponsor to this latest blow against his empire.⁷⁰ At a meeting of TsKBEM senior staff on January 3, 1970, Ustinov offered his complete backing and ordered the preparation of a formal Communist Party and government decree on the matter."

It may have been a brilliant idea for Ustinov, but implementing the concept proved to be a little more difficult. Ustinov did not want to deal directly with Chelomey's central organization, and thus he invited a subsidiary of Chelomey's design bureau, his Fili Branch, to the preliminary discussions with Mishin. This cooperation between two unlikely partners was, in fact, stipulated in Ustinov's initial order to Mishin to:

- Have the space station ready in a year to a year and a half
- Make maximal use of ready instrumentation from the Soyuz spacecraft
- Arrange with the chief of TsKBEM's Fili Branch, Viktor N. Bugayskiy, concerning the participation of that branch in the new program⁷²

TsKBEM's Fili Branch had a long and distinguished history in the Soviet aviation, rocketry, and space industries. In the 1950s, it had been an independent design bureau (OKB-23), headed by the famous Chief Designer Myasishchev, and had built some of the most famous long-range bombers for the Soviet Air Force. Among its more ambitious, albeit unrealized, achievements was the conceptualization of one of the Soviet Union's first spaceplanes, the M-48, as well as an intercontinental cruise missile, the Buran. After it was subordinated to Chelomey's design bureau in 1960 as Branch No. 1, the organization slowly shifted its design focus to ICBMs and space launch vehicles. Under Chelomey's general leadership, the branch created the UR-200 ICBM (later canceled), the UR-100 ICBM, and the UR-500 (Proton) launch vehicle." All of these rockets were manufactured at the massive M. V. Khrunichev Machine Building Plant, collocated with the Fili Branch in Moscow.

Detailed discussions on the cooperation between TsKBEM and TsKBEM's Fili Branch took place in January 1970 at Bakovskiy near Moscow, where Mishin was on holiday at the time. Ustinov evidently presided over the negotiations, which were attended not only by Mishin and Bugayskiy, but also the director of the Khrunichev Plant, Mikhail I. Ryzhikh. It was then that "basic questions were solved about the joint work of the three organizations in the development and creation of the orbital station."⁷⁴ There were also exchange visits among the three entities. On January 4, Mishin visited the Khrunichev Plant, while the following day Bugayskiy and Ryzhikh returned the favor by visiting Mishin's design bureau at Kaliningrad. Ustinov completely excluded Chelomey from the negotiations, despite the fact his First Deputy, Bugayskiy, was an essential participant in the talks. The discussions culminated with a decree (no. 105-41) of the Central Committee and the USSR Council of Ministers dated February 9.

70 See Chugunova "Chelomey's Cosmonauts" for Chelomey's reaction upon hearing of the idea and his suspicions of Ustinov

71 The preparation of the decree was entrusted to A. I. Tsarev (VPK), K. A. Kerimov (MOM) and K. D. Bushuyev (TsKBEM)

72 Petrakov, "Soviet Orbital Stations"

73 Zhiltsov ed. *Gosudarstvennyy kosmicheskii* pp. 56-65. By 1970 it had already begun the development of two modifications of the UR-100 ICBM designated the UR-100M and the UR-100K. Note that the UR-500 Proton had begun development as an ICBM with orbital weapons delivery system

74 Petrakov "Soviet Orbital Stations"

1970, which called for the development of a new space station complex, the DOS-7K.⁷⁵ "DOS" stood for "Long-Duration Orbital Station" and represented the station proper, while the 7K denoted the Soyuz ferry vehicle. In later years, it would publicly be known first as *Salyut* and later as *Mir*. Apart from formally approving the project, the decree also stipulated the transfer of an already manufactured hull of Chelomey's Almaz station to the hands of Mishin's engineers. The latter, in cooperation with people under Bugayskiy and Ryzhikh, would reequip the Almaz to create the DOS vehicle."

By the time that the Soviet leadership issued a formal decree on the DOS, the leaders of the relevant organizations had already shuffled their priorities to bring a high priority to the program. By late December 1969, Bugayskiy's Fili Branch had established a group of "lead designers" for the orbital station project headed by Vladimir V. Pallo, which included veterans of the group that had designed the Proton booster." At Mishin's design bureau, the senior staff had proposed the appointment of thirty-four-year-old Yuriy P. Semenov as the "lead designer" of the DOS-7K complex, a position that gave him direct design control over the project. Semenov had served in the same capacity since May 1967 for the LI circumlunar project, a remarkable distinction for such a young man. A clearly competent engineer, it was rumored that his rapid rise was owed in part to the fact that he was the son-in-law of Politburo member Andrey P. Kirilenko.⁷⁶ On February 4, Mishin handed out assignments on the DOS-7K project. As one would expect, most of the key assignments went to those who had proposed the project in the first place, including Bushuyev, Chertok, and Feoktistov.⁷⁷

In Soviet terms, the pace and acceleration of the project were remarkable. By December 31, 1969, literally in the course of a few days, TsKBEM engineers prepared a document, "Basic Provisions for an Orbital Station," which was the precise origin of the DOS-7K design. In February 1970, the design bureau's Department No. 241 issued the technical plan for the DOS, with which the leadership of TsKBEM's Fili Branch concurred. In early March, a group of engineers from TsKBEM, TsKBEM's Fili Branch, and the Khrunichev Plant met for the first time to discuss the project and agreed on the basic requirements and direction of work." The distribution of labor among the three enterprises laid the foundation for a cooperation that

⁷⁵ *Ibid.*, Semenov, ed., *Raketno-Kosmicheskaya Korporatsiya*, p. 267. Zhiltsov, ed., *Qosudarstvennyy kosmicheskoy*, p. 75

⁷⁶ A subsequent decree (no. 57ss) of the Mntstry of General Machine Building (MOM) dated February 16, 1970, also specified more details of each side's participation in the project. See Zhiltsov, ed., *Qosudarstvennyy kosmicheskoy*, p. 75.

⁷⁷ *Ibid.*: C. Amiryants, "Ivensen's 'Chayka'" (English title), *Aviatsiya i kosmonautika* no. 4 (April 1990) 36-38. Andrey Tarasov, "Space Science of the Future: Selection of Paths and Orbits" (English title), *Prauda*, May 17, 1990, p. 3.

⁷⁸ Semenov's official appointment as lead designer of the DOS-7K complex, dated January 20, 1970, has been reproduced in full in Semenov, ed., *Raketno-Kosmicheskaya Korporatsiya*, p. 265-66. For a biography of Semenov, see K. Lantratov, "Yu. P. Semenov (on 60 Years)" (English title), *Novosti kosmonautiki* 6 (April 9-22, 1995): 54-55. For the Kirilenko connection, see Roald Z. Sagdeev, *The Making of a Soviet Scientist: My Adventures in Nuclear Fusion and Space From Stalin to Star Wars* (New York: John Wiley & Sons, 1993), p. 180.

⁷⁹ The main assignments were: Yu. P. Semenov (lead designer for the DOS-7K complex), K. D. Bushuyev (chief of DOS-7K development), K. P. Feoktistov (deputy chief of DOS-7K development), P. V. Tsybin (lead designer for the 7K ferry ship), L. A. Corshkov (lead designer for the DOS orbital block), B. Ye. Chertok (chief of the guidance system), B. V. Raushenbakh (deputy chief of the guidance system), I. Ye. Yurasov (deputy chief of the guidance system), Ya. I. Tregub (chief of flight tests), V. I. Zelenshchikov (deputy chief of flight tests), and A. P. Abramov (chief of the ground complex, technical position, and fueling equipment).

⁸⁰ Semenov, ed., *Raketno-Kosmicheskaya Korporatsiya*, p. 266. Among those present were Ye. A. Bashkin, E. K. Demchenko, K. P. Feoktistov, L. A. Gorshkov, A. A. Nesterenko, and Yu. P. Semenov from TsKBEM, V. N. Bugayskiy, G. D. Dermichev, Ya. B. Nodelman, and V. V. Pallo from TsKBEM's Fili Branch, and B. G. Britkov, Ye. M. Kupryakov, M. P. Parfenov, and A. I. Tsimmerman from the Khrunchev Plant.

existed among the same three entities into the 1990s in the design, development, testing, and launch of the *Mir* space station and its various add-on modules. Never before had the Soviet space industry engaged in such a cooperative project that was primarily civilian in nature.

Mishin's TsKBEM worked on the overall design of the station, supplied almost all the complete systems, developed new systems for the station, ensured the launch and return of station crews, and had control over flights. It also manufactured the basic systems of the station and carried out preflight testing of the fully built station. Bugayskiy's TsKBM Fili Branch developed the layout of the station, carried out modeling, developed a small portion of the systems, issued the design documentation, supervised the manufacturing at the plant, and participated in the preparation of the station at the launch site. The Khrunichev Plant had already manufactured the pressure hull, manufactured new ones at its Building 160, and carried out the full assembly of the product "

As soon as the official government decree was issued, the leading architects for the DOS—Bushuyev, Feoktistov, and Semenov—developed a simplified initial concept for the station, which was then delivered to Bugayskiy's team. At the basic level, the designers introduced four major modifications to Chelomey's Almaz station to turn it into the DOS:

- A new transitional compartment with a passive docking node, which forced a redesign of the forward bulkhead
- A truncated airlock compartment at the rear of the station with deletion of the associated passive docking node
- A new aggregate compartment at the rear of the station with a much smaller diameter than the rest of the station, which would contain the main engines
- New large solar panels installed like wings on the transitional and aggregate compartments (the old Almaz panels would be deleted)"

These initial changes to the Almaz station design were incorporated into a special wooden mock-up of the station built to specifications at the Fili Branch. More difficult was the actual appropriation of the several complete Almaz models, which Chelomey naturally was reluctant to give up. In March 1970, DOS lead designer Semenov for the first time met with Chelomey at the latter's offices in Reutov. The meeting was long and did not go very well; the proud Chelomey evidently gave Semenov an earful. The younger man invoked the recently passed Central Committee and Council of Ministers decree, but Chelomey refused to give in. It was only after personal intervention by Minister of General Machine Building Afanasyev that the matter was resolved. Chelomey capitulated and handed over four already-built hulls of the Almaz station to Mishin's engineers." Ultimately, eight station hulls, associated equipment, and documentation were transferred to the DOS program. All of this was done via Chelomey's Fili Branch—that is, without going through the general designer. One of Chelomey's deputies recalled:

The TsKBM Branch was instructed to hand over all blueprints related to the TsKBEM project. Chelomey's Deputy at the Branch implemented the order, having made the diazo-type copies of our drawings, and he had not even wiped out our signatures from the developed drawings related to the DOS . . . which he handed over.⁸⁴

81 *Ibid* p 268 Zhiltsov ed *Cosudarstvennyy kosmicheskii* p 74

82 Zhiltsov ed *Cosudarstvennyy kosmicheskii* p 75 Petrakov "Soviet Orbital Stations "

83 Semenov ed *Raketno-Kosmicheskaya Korporatsiya* p 267 Another source says that the MOM order dating from February 16 1970 stipulated that six Almaz stations were to be turned over from Chelomey to Mishin. See K. Lantratov 'Dmitriy Kozlov's Zvezda ' (English title) *Novosti kosmonavтики* 6 (March 10–23 1997) 74–80

84 Polyachenko 'The Pep of Almaz ' p 19

The convoluted story behind the genesis of the DOS could have been the brainchild of an author intent on confusing readers, a maze of abrupt turns, shifting alliances, and ultimately betrayal. No one could have possibly predicted such an outcome. Chelomey was ordered to hand over all his Almaz materials to Mishin, while at the same time, one of Chelomey's own branches was ordered to cooperate with Mishin on the project. And all this happened when both Chelomey and Mishin opposed the idea. For Chelomey, this was a blow of proportions comparable to the immediate post-Khrushchev period when the bottom fell out of so many of his programs. After that near catastrophe, he saw one after another of his piloted space projects disappear. Although he had a fairly strong automated space program, he staked all his hopes to claim some of the glory of the piloted space effort on Almaz. But his Almaz was near death. He was consoled by the fact that Ustinov was not singularly powerful enough to completely kill the military Almaz. Although it would be delayed, perhaps as much as two or three years, Ministry of Defense support ensured that eventually Chelomey would see his coveted Almaz fly in space.

Bugayskiy was put in an awkward position. He had had a distinguished career working as a deputy to renowned Soviet aircraft designer Sergey V. Ilyushin at OKB-240, where he led work on the famous Il-2 during World War II. He joined Chelomey's design bureau in 1960 to direct the plant production of the P-5 naval missile. The two men evidently had "excellent relations" with each other: while Chelomey had the creative vision, Bugayskiy knew how to work at the plant level, converting that vision into reality." When, in 1960, Chelomey inherited the Fili Branch, he put Bugayskiy in charge. Throughout the 1960s, Bugayskiy was officially Chelomey's First Deputy, and thus ultimately responsible to him and no one else. But torn between Ustinov's whims and Chelomey's rank, he became a consistent supporter of the DOS despite heavy criticism from his boss. Chelomey was unable to dismiss Bugayskiy. With the help of the Ministry of Defense, Chelomey did manage to pass through an order limiting the number of employees at the Fili Branch who could work on the DOS. Opinions within the branch were divided—some supporting Chelomey, others Bugayskiy." It was a remarkably discordant management situation. For his part, Chief Designer Mishin had been adamantly opposed to the DOS decision, believing it to be a diversion from the NI-L3 program. Writing twenty years later, his opinions apparently had not changed:

The decision made no sense to me [and it still makes no sense to me now], inasmuch as the work on the Almaz orbital station was being done at the same time that work was being done on [the DOS]. . . . It would have been wiser to combine the efforts of both OKBs to develop a unified orbital station and to entrust that work to . . . Chelomey's firm, which

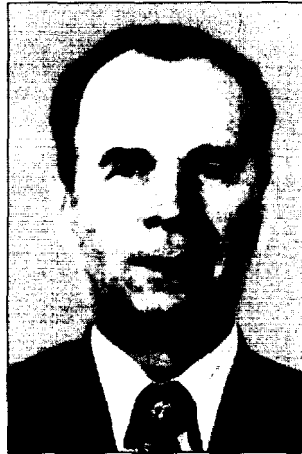

Viktor Bugayskiy was the chief of the Chelomey design bureau's Branch NO 1 at Fili in Moscow. A veteran of the Ilyushin design bureau, Bugayskiy was primarily responsible for the serial production of Chelomey's many ballistic missiles and spacecraft. He was one of the principal architects of the first Salyut space station in 1970-71 (files of Peter Gorin)

85 Telephone interview Sergey Nikitich Khrushchev by the author October 10 1996 V M Petrakov 'From the History of Development and Creation of Carrier Rockets in the USSR' (English title) in Trudy XXup cht eniy posuyashchennykh rarrabotke nauchnogo nasladenrya i razvitiyu idey K E Tsiolkovskogo (Moscow RAN 1994) p 170

86 Petrakov "Soviet Orbital Stations "

had long been working on that area. *Such* a decision would have relieved the burden being carried by our OKB substantially and would *have* given us the opportunity to concentrate our efforts on the work on the *NI-L3* program."

He added:

The decision could not help but complicate our relations *with* V N. Chelomey, which were already strained because of the transfer to us (while Sergey Pavlovich [*Korolev*] was still alive) of subsequent work on the circumlunar *flight*.⁸⁷

It was one of those rare instances when Chelomey and Mishin actually agreed on something, but their combined might could not stop the newest space station program. The manufacture of the first DOS flight article began at the Khrunichev Plant in February 1970, the first in a line of space vehicles that would ultimately lead to the Mir space station.

Eighteen Days

The Almaz was not the only casualty of the DOS decision. Concurrent with the decision to proceed with the DOS, on February 9, 1970, all work on the Soyuz-VI small military orbital station was terminated. Given the capabilities of the DOS, Ustinov believed that there was no rational need to have two space station programs at TsKBEM. The cancellation of Soyuz-VI was opposed by certain individuals in the military who had been patiently waiting for more than five years for a military version of the Soyuz, seeing each program neutralized one after the other. There was one bright spot in the otherwise dismal state of piloted military programs: while Minister Afanasyev canceled work on the OB-VI station portion of Soyuz-VI, he allowed work to continue on the 7K-S transport ship of the complex because he considered it "promising and having many improved characteristics compared to the [basic] 7K-OK [Soyuz]."⁸⁸ The 7K-S, with improved avionics, communications, safety, and capability characteristics over the basic Soyuz, would serve as the basis for autonomous military research Soyuz spacecraft in the 7K-S-I and 7K-S-II variants. A third version would serve as a ferry spacecraft to future DOS stations in Earth orbit. Mishin's interest in pursuing the 7K-S variant meant that funding for it was increased significantly by mid-1970, although progress was evidently slow because of a lack of facilities at the design bureau's plant. A first piloted flight was not expected until 1972-73.

The first DOS mission was scheduled for early 1971 at best. To fill the gap between piloted flights, Mishin had plans to conduct two Soyuz missions during 1970, each comprising two 7K-OK spacecraft that would dock with each other using the lunar Kontakt rendezvous radar system. One of these missions would also include a twenty-day long-duration flight of two cosmonauts in Earth orbit. By late December 1969, it was clear that the Kontakt system would not be ready for the 100th birthday of Lenin in April 1970, the target date for the first docking mission. Instead, Mishin formulated a plan to launch a single 7K-OK, spacecraft no. 17, with two cosmonauts on the twenty-day flight in April 1970.⁹⁰ In January 1970, the Military-Industrial Commission issued a formal decree for an eighteen-day flight, with the length of

87 Mishin "Why Didn't We Fly to the Moon?"

88 *Ibid*

89 Lantratov "Dmitriy Kozlov's Zvezda"; Semenov ed. *Raketo Kosmicheskaya Korporatsiya* p 211
The cosmonaut group for the Soyuz-VI program finally disbanded in August 1970

90 There were apparently at least three other options to celebrate the April 1970 deadline including one using the 7K OK to dock with an Almaz Orbital Piloted Station (OPS) and another using the 7K S to dock with an Almaz OPS

duration determined by the safety reserves aboard the relatively cramped Soyuz spaceship. Such a flight would break the fourteen-day record set by the two Gemini VII astronauts almost five years earlier. This eighteen-day flight would then be followed by the Kontakt docking mission, perhaps as early as August 1970.

Six cosmonauts had begun training for the long-duration mission by November 1969, including primary contenders Nikolayev and Sevastyanov, who had lost their chance to fly on Soyuz 8 earlier in the year because of poor preflight preparations.⁹¹ Insufficient training of the crew was also evidently a factor in postponing the new mission from early April to late May 1970. Apart from the purely physiological goals of monitoring the effects of prolonged microgravity, the two cosmonauts were also to reperform some of the rendezvous maneuvers tried in vain during the triple-Soyuz flight in late 1969. Their Soyuz ship would carry a new computer, named the Spacecraft Analogical Machine, to allow rendezvous in orbit with an imaginary target." The computer was capable of locating targets at a range of thirty to fifty kilometers and of providing input on subsequent maneuvers. Throughout early 1970, the cosmonauts training for the flight performed extensive full-length flight simulations at the Gagarin Cosmonaut Training Center at Zvezdnyy gorodok to prepare for the mission. These were carried out to establish a "proper balance between reserve capacity of the air regenerative system and the metabolic processes of the crew." Simulations included complete eighteen-day missions with ground crews matching the exact schedule planned for the mission. The cosmonauts used new state-of-the-art biomedical monitoring equipment as well as improved waste disposal systems.

On May 20, 1970, the Soviet Strategic Missile Forces launched a Zenit-4 reconnaissance satellite into orbit from site 31 at Tyura-Tam. Named Kosmos-345 by the Soviet press, the satellite was launched from the same pad that was set aside for use for the long-duration flight. Because of extremely high winds at the launch site, up to and above twenty meters per second, there was some damage when the plumes from the rocket exhaust singed the launch trusses and cables of the pad structure. Pad personnel assured the Soyuz State Commission that repairs would be finished prior to the planned launch on May 31. Subsequent problems during ground testing of the 7K-OK vehicle at Tyura-Tam put that target date in question. During the integrated testing of the ship, engineers detected intermittent currents in its electrical system, measuring as much as sixty volts, instead of the nominal thirty-eight volts. Unusually, most of the members of the twenty-person State Commission had not arrived at the Baykonur Cosmodrome by this time. Air Force Aide Kamanin noted in his diary on May 22: "The attitude toward the preparations for the prolonged space flight, beginning with the highest leaders and ending with the rank-and-file workers, is mostly nonchalant."⁹⁴

There was somewhat of a minor crisis on the evening of May 25, when Kamanin discovered primary crew Commander Nikolayev smoking a cigarette in direct violation of orders not to do so at the Baykonur Cosmodrome. Later, Sevastyanov also admitted that he had also been smoking contrary to medical orders. Kamanin was aghast, especially given that Nikolayev had been caught doing the same thing the previous December and had promised to quit smoking. The general noted with frustration that:

If I had learned of this a month ago, I would have been against allowing Nikolayev and Sevastyanov to fly, but now, when there are only a few days left until the launch, and

91. The other cosmonauts in training by April 1970 were A. V. Filipchenko, G. M. Crechko, V. C. Lazarev, and V. I. Yazdovskiy.

92. Hooper and Vis, "Meeting the Space Explorers Vitali Sevastyanov"

93. "Big Booster Paces Soviet Manned Flights." Aviation Week & Space Technology, July 6, 1970, p. 18

94. Kamanin, "Removing the Cosmetic Retouching."

*Nikolayev's crew has already been confirmed in fact as the primary crew in the Party's Central Committee and the government. it is impossible to raise the matter of replacing the cosmonauts with their backups*⁹⁵

In the meantime. Minister of General Machine Building Afanasyev telephoned Mishin at Tyura-Tam that the Politburo had just discussed the impending flight. They had recommended that the press communiques regarding the mission be low key, without all the pomp associated with past Soyuz missions.

On the evening of May 31, the complete State Commission met to formally approve the launch date and time of the launch, set for exactly midnight local time on June 1. At a subsequent press conference. Nikolayev and Sevastyanov were forbidden to talk about the main feature of the flight, its record-breaking length, and instead uttered the usual generalities. There seems to have been some tension between factions in the State Commission over the issue of length, a latent conflict that did not abate through the following weeks. Some, like Kamanin. were adamant that the length be limited to eighteen days, while others, like Mishin, were hoping for a possible extension to twenty days. On the afternoon of launch day. Kamanin tried to preempt any conflicts on the issue by explicitly forbidding either cosmonaut from asking for an extension of the flight over eighteen days once they were in space. Kamanin's concern was that any extension would severely strain the capabilities of the old Soyuz spacecraft and perhaps put the lives of the crew in jeopardy.

Throughout the day. Strategic Missile Forces personnel carried out all prelaunch procedures on time. The cosmonauts arrived at the pad a little over two hours prior to launch. Without further ado, the Soyuz spaceship lifted off precisely on time at 2200 hours Moscow Time on June 1, 1970, with forty-year-old Colonel Andrian G. Nikolayev as the commander and thirty-four-year-old civilian Vitaliy I. Sevastyanov as the flight engineer. The spaceship, named Soyuz 9, entered an initial orbit of 208 by 220.6 kilometers at a 51.7-degree inclination. For Nikolayev, it was his second spaceflight, having flown in space eight years before in 1962 as the pilot of Vostok 3. Sevastyanov was the fourth civilian engineer from TSKBEM to fly in space. NASA astronaut Neil A. Armstrong, the first human to set foot on the Moon, was on an official visit to the Soviet Union at the time. On the night of the launch, at the Cosmonaut Training Center near Moscow, he was clearly surprised when his host, cosmonaut Maj. General Beregovoy, turned on the TV to view film of the Soyuz 9 launch. Beregovoy reportedly told Armstrong. "This is in your honor."

On their first day in space, the Soyuz 9 crew carried out two orbital maneuvers—the first on the fourteenth orbit to 213 by 267 kilometers and the second on the seventeenth orbit to 247 by 266 kilometers—sufficient enough to prevent orbital decay without additional maneuvers." These maneuvers may have also been related to the mock rendezvous with an imaginary target. The two men began their extensive scientific experiments program by the end of their first orbit. Within the first three to four days in orbit, ground controllers were already finding out that they would have to plan future long-duration missions differently. For example, the cosmonauts reported that they required nearly fifty minutes to complete their set of physical exercises, whereas they managed to do them in a half-hour during preflight training.

On June 4, most of the members of the State Commission, including Chairman Kerimov. Minister Afanasyev, Chief Designer Mishin, and Commander of Space Assets Karas, left Tyura-Tam for Moscow. In charge at the control point at the launch site were Col. General Kamanin and TSKBEM Deputy Chief Designer Yakov I. Tregub. During the latter part of the day.

95 *Ibid*

96 Smolders *Soviets in Space* p 186 Riabchikov *Russians in Space* p 277

97 Petrov *Conquest of Outer Space* pp 171-73

there was some alarm when ground readings showed that because of intermittent operation of the solar arrays' automatic equipment, the storage buffer batteries were showing higher levels of charge than normal. On the forty-seventh orbit, Sevastyanov reported that although the solar arrays had been turned off, the current in the batteries was twenty-six amperes, clearly indicating a malfunction in the control switch for the panels. During the previous two days of flight, the crew had to turn off the solar arrays manually more than twelve times, close to the limit of fifteen times the operation could be repeated.⁹⁸ One reason for the excess power was beyond the control of the ground or the crew. On this flight, the duration of "nighttime" was only forty seconds instead of the dozens of minutes on earlier Soyuz missions. Because the orbit of the current mission was such that the ship's orbit was nearly parallel with the terminator, the solar arrays were generating a nearly continuous stream of electric current. To compensate, the flight control team ordered the crew to turn the ship around at a rate of a half degree per second to turn the arrays away from the Sun. The solar panel switching system began operating normally the following day, indicating that either Sevastyanov had reported incorrect readings the previous day or that it had been a "self-repairing" problem.

A week into the mission, already the longest Soviet space mission, all systems seemed to be nominal. The cosmonauts reported that they felt significantly better on the sixth day than on the first two to three days of the flight. There were again murmurs of talk about extending the flight to twenty days, but such prognostication proved too premature at this point. One of the few negative indicators of the crew's health was the reduced consumption of drinking water (one liter per day) and oxygen (seventeen liters per day), indicating some fatigue. On June 10, Nikolayev and Sevastyanov had their first day off, and they spent time playing a game of chess with Kamanin and veteran cosmonaut Corbatko on the ground. The players advanced their pieces twenty-five times over three orbits before agreeing to a draw.⁹⁹ The crew displayed the first real signs of fatigue and decrease in working efficiency on their twelfth day in orbit. Kamanin wrote in his diary that:

Nikolayev and Sevastyanov look somewhat puffy, and listlessness and irritability can be sensed in their actions. After talking things over with the cosmonauts, we decided to shorten significantly for the subsequent days of the flight the volume of experiments and to increase the rest periods."

The activities of the Soyuz 9 crew in space were fairly intensive for such a relatively small spacecraft, with working days lasting on average between fourteen and sixteen hours. Both exercised twice a day in the living compartment with an expansion device that required an exertion tension of ten kilograms. On occasion, they wore a special suit named *Pinguin* ("Penguin") to simulate some of the effects of Earth's gravity. They assessed their condition before and after each exercise regime, recording arterial pressure, pulse, respiration, and contrast sensitivity of their eyes. The average daily calorific content for each cosmonaut was about 2,600 kilocalories. For the first time, a Soviet piloted spaceship carried a food heater, which allowed the crew not only to heat up their food, but also to get a fresh cup of coffee in the "morning." The men could not take baths in the ship, but they used wet and dry towels for rubdowns twice a day for personal hygiene. They were allowed a change of underwear once

⁹⁸ Kamanin. "Removing the Cosmetic Retouching." The limit of fifteen times was because every time the cosmonauts turned the switch off, hydrogen accumulated in the instrument compartment. With increasing amounts of hazardous hydrogen in the module, the controllers would have had to cut the flight short after eight days in space.

⁹⁹ *Ibid.*: Riabchikov. *Russians in Space*, p. 280

¹⁰⁰ Kamanin. "Removing the Cosmetic Retouching."

a week. On this first space mission lasting more than two weeks, the cosmonauts maintained only intermittent contact with their families. On the birthday of Nikolayev's daughter Elena, she came to the Flight Control Center with her mother, former cosmonaut Valentina V. Nikolayeva-Tereshkova, to talk to her father via both video and audio.¹⁰¹

The actual scientific experimentation consisted of fifty experiments in various categories. On their fourth day in space, the crew used a new stellar sensor to calculate the orbital parameters and geographical latitude of the point above which the ship was flying, relative to the position of a selected star above the horizon, Vega in the Lyra constellation. The cosmonauts carried out this experiment, complicated by the motion and drift of Soyuz 9, over a period of two complete orbits without any communications with the ground as they manually maintained attitude and measured drift of the ship's gyroscopes. Other navigational exercises involved the use of the SMK-6 sextant, used in combination with solar and stellar sensors and an optical device in the spacecraft. On their fourteenth day, the cosmonauts explored the possibility of checking orientation with less "popular" stars, such as Arcturus, Deneb, and others, in conjunction with ground reference points on Earth, including lakes and mountains in Africa and South America. All these experiments led to precise determination of orbital elements to refine future rendezvous exercises.¹⁰²

As usual, Earth photography comprised a large part of their work time and resulted in 1,000 pictures by the end of the mission. These included a special experiment on June 13 on Soyuz 9's 189th orbit. The crew investigated weather formations in the atmosphere and western portion of the Indian Ocean as part of an integrated exercise that included a Meteor-1 satellite at an altitude of 600 kilometers, the Soyuz 9 vehicle at 240 kilometers, and sounding balloons launched from the scientific research vessel Akademik Shirshov of the USSR Hydrometeorological Service located in the Indian Ocean. Less intensive observations included those of a large tropical storm in the Indian Ocean on their fifth day and forest fires in Africa near Lake Chad the day after. On the thirteenth day, the crew used both black-and-white and multispectral color film to identify different kinds of rock and soil on Earth, the moisture content of glaciers, the location of shoals of fish, and timber reserves. They studied aerosol particles in the atmosphere by observing twilight glow and carried out spectrographic measurements of the horizon to enhance definition of the horizon for navigational purposes. They also used the RSS-2 handheld spectrograph to make 200 spectrophotometric measurements of natural formations in different parts of the world. The same type of instrument had been used on Soyuz 7 the previous year. On day seventeen, they performed some brief photography of the Moon.¹⁰³

Biomedical tests comprised a major part of their activities. On their ninth day in space, they reported that they were collecting air samples of their breathing before and after exercise to study the ration of oxygen and carbon dioxide. On day thirteen, Sevastyanov carried out a test of his mental capabilities by performing a simulated set of commands that had been preprogrammed into the on-board computer. His results would be compared to his performance before the flight on the same test. Nonhuman studies included those related to the micro and macro genesis of plants, the division of chlorella cells, the propagation of bacterial cultures in liquid media, and the development of insects in weightlessness.

As they were winding down their experiments program, there were some minor problems. At the scheduled beginning of their communications session on June 15, ground controllers were unable to wake up the crew despite three minutes of increasingly frantic calls. Both men

¹⁰¹ Riabchikov *Russians in Space* p 280 Narimanov *Ot kosmicheskikh korably* pp 77-80 Smolders *Soviets in Space* p 192 *Soviet Space Programs 1966-70* p 238

¹⁰² Nartmanov *Ot kosmicheskikh korably* pp 81-83

¹⁰³ Riabchikov *Russians in Space* pp 280-81 *Soviet Space Programs 1966-70* p 239 K Y Kondratyev *et al* "Some Results of Spectrophotometry of Natural Formations From the Manned Spaceship Soyuz 9" (English title) *Kosmicheskiye issledovaniya* 10 (March-April 1972) 245-54

apologized for sleeping through their wake-up time, but Sevastyanov, groggy from having been woken up, inadvertently switched on the button for the automatic landing system display when attempting to switch on the cabin light. It was an exact repeat of the situation on Soyuz 7, when the system, designed to operate after reentry at an altitude of eleven kilometers, remained turned on in space through the rest of the mission. Later the same day, the crew altered their orbit a third time, by firing their engine on orbit number 208. The following day, there was further anxiety when one of the batteries of the telemetry system failed, dropping out telemetry for a number of important parameters on the ship's systems. Both Chief Designers Mishin and Ryazanskiy, the latter responsible for the offending component, assured the State Commission that this was not a threat to continued flight.

There was an expanded meeting of the State Commission on June 16, when Mishin casually asked ballistics experts what the orbital parameters would be on the twentieth day of flight, clearly implying that he was interested in extending the mission from the planned eighteen days. The issue over mission length, a common conflict during many Soviet piloted space missions of the era, spilt out in the open during lunch the same day, when Mishin and Kamanin went head to head against each other. According to Kamanin:

Mishin did not hold back and asked me, am I of a mind to fight? Knowing what he was driving at, I responded that, for the time being, I see no reasons for shortening the flight program. I did not begin to talk about the fact that members of the landing commission from the industry—[Chief Designers] Severin, Tkachev, and Darevskiy—had urgently requested that I not permit an increase in the duration of the Soyuz-9's flight beyond the [eighteen-day] program.¹⁰⁴

From Soyuz 9 Commander Nikolayev's reports, it was clear that while food rations could be extended to twenty days, it would be difficult at best, and probably not worth the risk. The issue was finally resolved at a meeting of the inner circle of the State Commission on June 16. Both State Commission Chairman Kerimov and Mishin were clearly under political pressure to extend the flight to twenty days. Mishin's suggestion for an extension was, however, not taken lightly by the other attendees. Five men came out against Mishin. In frustration, Mishin turned on Ministry of Health representative Yevgeniy I. Vorobyev, responsible for dietary needs, accusing him of not providing enough food for twenty days. The final decision was to perform the landing on June 19, after eighteen days. Kamanin noted in his diary: "V. P. Mishin and K. A. Kerimov, having promised the high command in Moscow that they would carry the flight out to 20 days, will now have to concur with our decision."¹⁰⁵

The last two days in orbit were relatively quiet for both the crew and ground controllers. On the morning of June 17, Kerimov, Mishin, and Kamanin congratulated the two cosmonauts on officially exceeding the record set by Gemini VII in 1965, thus reclaiming for the Soviet Union the absolute endurance record for a spaceflight. A day later, the State Commission approved a plan to land Soyuz 9 on its 287th orbit. In case of a possible ballistic reentry, the commission stationed a contingent of recovery forces, including amphibious craft, three

¹⁰⁴ Kamanin, "Removing the Cosmetic Retouching." The chief designers were C. I. Severin of KB Zvezda (for spacesuits), N. A. Lobanov of NII AU (for parachutes), and S. C. Darevskiy of SOKB LII (for ground simulators and avionics).

¹⁰⁵ *Ibid.* The other members of the inner circle were P. A. Agadzhanov (Deputy Chief of TsKIK and also Chief of GOGU), B. Ye. Chertok (Deputy Chief Designer of TsKBEM), N. P. Kamanin (Air Force Commander in Chief's Aide for Space), K. A. Kerimov (Chief of the Third Chief Directorate MOM), Ya. I. Tregub (Deputy Chief Designer of TsKBEM), and Ye. I. Vorobyev (Chief of the Third Directorate, Ministry of Health).

helicopters, five sea launchers, and fifteen fishing vessels, in the Aral Sea. Nikolayev and Sevastyanov's journey back to Earth began on the afternoon of June 19. At least 150 people, including Minister Afanasyev, were present at the Flight Control Center at Yevpatoriya to observe the proceedings. Air Defense Forces radars tracked the capsule from an altitude of eight-three kilometers all the way down to parachute deployment. The whole crowd at the center burst into applause upon hearing Nikolayev's radioed message on a safe landing. Because of the precision of the landing, two helicopters were able to film the descending capsule and landed almost simultaneously with the cosmonauts. The Soyuz 9 ship landed seventy-five kilometers west of Karaganda at 1459 hours Moscow Time after a flight lasting seventeen days, sixteen hours, fifty-eight minutes, and fifty-five seconds. For the first time in more than four years, the Soviet Union held the absolute record for the longest piloted spaceflight.

When ground crews reached the cosmonauts, they found that the cosmonauts were unable to get out of the ship themselves and had to carry them out. After much discussion and dissent on the issue, Military-Industrial Commission Chairman Smirnov finally decided to cancel the immediate flight of the crew to Moscow's Vnukovo Airport. Instead, the cosmonauts remained at Karaganda for a day and arrived in Moscow on June 20 at Chkalovskaya Airfield. The plan was to escort the cosmonauts to the Cosmonaut Training Center for a press conference, but once Kamanin entered the aircraft to talk to the crew, these plans were changed. He wrote in his journal:

When I entered the aircraft's cabin, *Sevastyanov* was sitting on the sofa, while *Nikoiayev* was at a small table. I knew they were having a hard time enduring the return to the ground, but I had not counted on seeing them in such a sorry state. Pale, puffy, apathetic, without the spark of vitality in their eyes—they gave the impression of completely emaciated, sick people.¹⁰⁶

The crew was eventually escorted off the plane by cosmonauts Shatalov and Yeliseyev, although both had said earlier that they could walk by themselves. In a weak voice, Nikolayev, the more debilitated of the two, gave a very brief speech about fulfilling their mission and being ready for another one. He and Sevastyanov were then put into cars and sent to the care of an Air Force medical support group at Zvezdnyy gorodok.

Over the period of the next few days, it was increasingly clear that part of the reason for the very poor shape of the Soyuz 9 crew was the slow spin of the spacecraft throughout the mission. The spinning also produced a weak field of artificial gravity, which affected the clarity of results of several experiments aboard the ship. Nikolayev and Sevastyanov spent several days in quarantine, not only to protect their weak bodies from infections, but also, as it turns out, because of the discovery of a mutation of two microbes not occurring on Earth that were found in their metabolic systems. For five days after their return, the microbes spread very rapidly but then died from the effects of gravity. During this period, the two cosmonauts were fed through a safe bio-interface system.¹⁰⁷ Briefing sessions were held during their confinement with engineers, physicians, and other scientists. One journalist wrote: "They were pale, and their faces furrowed with wrinkles. They tried to carry on a lively conversation and even make jokes; but they tired rapidly, and there were frequent lapses."¹⁰⁸ For the first four or five nights, they slept

106 *Ibid*

107 Cordon R Hooper. *The Soviet Cosmonaut Team Volume 2 Cosmonaut Biographies* (Lowestoft UK GRH Publications 1990) p 264 Thomas O Toole "Soviet Union Still Trails U.S. in Space" *Washington Post* June 17 1973. pp A1 A8

108 Riabchikov *Russians in Space* p 282

fitfully, and the feelings of "acceleration" did not disappear until five or six days after landing. All ill symptoms finally disappeared eleven to thirteen days after landing. The men were sent off on short postflight vacation soon after.

The poor state of Nikolayev and Sevastyanov prompted a spate of debate over the issue of long-duration spaceflight. At one large postflight meeting at the Cosmonaut Training Center, two opposing factions expressed their views. Some believed that subsequent space missions should not exceed eighteen days by more than one or two days, and if the crew returned well after that, future missions could be extended conservatively. Other doctors argued that much longer missions were possible, but only with preventative measures such as medicine and exercising.¹⁰⁹ The debate over this issue to a significant degree affected plans for both the Almaz and DOS missions, with Soviet space officials looking to artificial gravity for very long missions on the Multirole Base-Station. Regardless of the condition of the cosmonauts, the Soyuz 9 mission was a landmark success for the Soyuz space program, precisely because it was the first fully unqualified success since the Soyuz 4/5 mission more than a year before.

Still Aiming for the Moon

It has been customary for Western observers of the Soviet space program to assume that the Soyuz 9 mission was the turning point for those involved the program—a signpost indicating their progression from quitting their piloted lunar program to creating Earth-orbital stations. This impression, partly supported by many official Soviet statements, has not been borne out by recent revelations. Even after Apollo 8, Apollo 11, and Apollo 12, the Soviets continued their vigorous search for successes on the Moon. When, in January 1969, Soviet space officials decided to move ahead with three different thematic directions—Earth-orbital stations, expanded lunar landings, and missions to Mars—all three were pursued for several years. Thus, in many ways, the story of the race to the Moon does not end in 1969—at least not for the Soviets. From both political and propaganda perspectives, future advanced lunar landings of cosmonauts offered a means to restore lost faith in the Soviet space program.

Much of the success of future lunar landings depended, of course, on the fate of the N1 rocket. The program had already been delayed by at least four years, and its record had been marred by two untimely failures in 1969. The investigation into the second failure in July 1969, which had destroyed one of the two available N1 pads at Tyura-Tam, was long and tedious. It took a full year before a formal report was ready on the accident, and even then there were multiple opinions on the cause of the accident within the investigation commission headed by Mishin. The reconstruction of the most probable chain of events was an exercise in detective work. A quarter of a second prior to liftoff, a metallic object, probably a portion of a steel diaphragm of a pressure oscillation sensor, had entered an oxidizer pump and caused engine number 8 of the first stage to explode. This disrupted the work of the on-board cabling network and damaged engines and telemetry instrumentation in the vicinity. As the lower part of the first stage was engulfed in fire, at T+0.6 second, the KORD system (for engine operation control) issued a command to shut down engine nos. 7, 8, 19, and 20. At T+8.76 seconds, it shut down engine no. 21 and its opposing engine no. 9. By T+10.15 seconds, all engines were shut down, except for engine no. 18, which continued to fire. The rocket, meanwhile, lifted up to a height of about 200 meters, and then it began to fall back vertically toward the launch pad, having been unable to turn on its nominal course because of the disruption of the cable network. The only operational engine gradually turned the rocket around its axis and, after

¹⁰⁹ Yu. A. Mozzhorin, et al., eds. *Dorogi v kosmos. I* (Moscow: MAI, 1992), p. 64



This remarkable photo of an NI booster on the still-intact pad at Tyura-Tam was taken from a U.S. CORONA photo-reconnaissance satellite on June 4, 1970. The three stages of the rocket, probably booster no. 6L, are clearly visible as is the associated pad structure (copyright Charles P. Vick, KH-4B mission 1110-2, launched May 20, 1970. Frame A148)

a twenty-three-second flight, the booster fell almost broadside onto the launch pad and completely exploded. Earlier, at T+14.5 seconds, the emergency rescue system activated and shot off the descent apparatus of the 7K-L1S spacecraft."¹¹⁰

Mishin's commission had found in its investigation that during ground testing of the first stage's NK-15 engines, large metal objects (dozens of millimeters in diameter) had the propensity to get into the oxidizer pump, damaging the impellers and causing ignition and explosion of the pump. Small metal objects (chips, fillings, and so on) burning in the gas generator resulted in the destruction of the turbine vanes. Finally, nonmetallic objects (rubber, rags, and so on), which were fed into the inlet of the turbopump assembly, did not cause disruption of engine work. Booster 5L, which had exploded in July 1969, had been among the first batch of manufactured NIs, and thus it did not have filters for foreign objects installed in the inlets to the pumps. According to the program specifications, these filters were scheduled to be installed beginning with booster no. 8L—that is, on the fifth launch attempt of the NI.¹¹¹

Mishin met with both Minister Afanasyev and Central Committee Secretary Ustinov in August 1969, explaining that the NI-L3 complex would still remain the primary system for researching the Moon. At a later meeting with Ustinov in September, Mishin was told that there would be a decision on the fate of the NI-L3 complex only after the causes of the July failure

110. Igor Afanasyev. "NI: Absolutely Secret" (English title). *Krylya rodiny* no. 9 (September 1993). 13-16; Semenov, ed. *Raketno-Kosmicheskaya Korporatsiya*, p. 257. The official report on the accident of booster 5L, in describing the initial cascade of events, states "In the time interval between -0.2 second and t0.25 second, the following happened. (a) the rocket's airframe was subjected to pulsed loading; (b) there was a sharp rise in temperature in the vicinity of engine nos. 7, 8, and 9; (c) the telemetry equipment of engine nos. 8 and 9 failed." See R. Dolgopyatov, B. Dorofeyev, and S. Kryukov. "At the Readers' Request. The NI Project" (English title). *Aviatsiya i kosmonavtika* no. 9 (September 1992). 34-37.

111. Afanasyev, "NI: Absolutely Secret."

had been determined. The immediate plans after the July 1969 failure of booster 5L had been to perform full-scale one-way automated landings of the Lunar Ship (LK) on the Moon on N I boosters 6L, 7L, and 8L. As the investigation into the disaster took longer and longer, these plans had to be shelved.

The fate of the N I rocket itself seemed central to the future of the Soviet space program as a special governmental commission examined the program as a whole following the second accident. Coming at the nadir of the Soviet hopes in the "space race," the recommendations of the commission were positive in outlook: the commission believed that the N I would be able to support all planned Soviet space projects for the subsequent ten to fifteen years." In December 1969, after a review of the July catastrophe, the Commander-in-Chief of the Strategic Missile Forces, Marshal Nikolay I. Krylov, made his feelings known on the program. Traditionally an opponent of piloted space programs, Marshal Krylov wrote to Minister of General Machine Building Afanasyev that:

The resulting analysis of the two failed launches of the N1-L3 complex, and also statistics from launches of other complicated rocket-space complexes show that the existing methods of developing rocket-space complexes do not ensure a high level of reliability upon entry into [flight-testing]. The existing methods of ground work on [rocket-space complexes], for the most part, are analogous to the methods of developing military missiles, which, as a rule, are considerably simpler than [rocket-space complexes] of the N1-L3 type. At the same time, the processes of [flight-testing] of military missiles differ by some tens of articles (from 20 to 60) to bring them up to a high level of reliability. In carrying out the [flight-design testing] of heavy [rocket-space complexes] the possibility of extended flight work is not feasible because of the great expenses of the rocket-carriers. In view of this, expedient changes in the volume and character of the ground work on these complexes up to the moment of entry to [flight-testing] should be introduced. In our opinion, new methods of ground work on heavy [rocket-space complexes] should include the basis for multi-use operations and [creation of] a large stock of resources of the complete system and equipment: preliminary firing tests of engines and rocket blocks without subsequent sorting out with the goal of discovering production defects and expirations of their working lives should also be carried out.¹¹³

The recommendations of Krylov, all clearly worthy of attention, were apparently taken into consideration in future planning for the program. One of the major changes during the 1969-70 period was reworking the procedural system by which engines for the first three stages of the N I were selected for flight. The original method, known as KONRID, consisted of an efficiency control system in which a batch of six randomly selected engines were submitted for a flight article. Of these, two would be static tested on the ground. Depending on the results, the *remaining* four would then be consigned for the flight article. This meant that the actual engines used on the N I were never tested prior to installation on the booster. Because the KONRID system had proved inadequate in the face of multiple engine failures on the first two launches, in July 1970, the Trud Design Bureau, under Chief Designer Kuznetsov, began using the old NK-15, NK-15V, and NK-21 engines of the first, second, and third stages of the booster to develop a new updated set of three engines. According to the technical assignment issued by TsKBEM, these

112 Georgiy Stepanovich Vetrov, "Development of Heavy Launch Vehicles in the USSR," presented at the 10th International Symposium on the History of Astronautics and Aeronautics Moscow State University Moscow, Russia, June 20-27, 1995

113 Semenov ed. *Raketno Kosmicheskaya Korporatsiya* p. 257

new engines would be capable of multiple firings, have much longer service lives, be delivered without reassembly after acceptance tests, and be tested on the ground prior to flight. Until these new engines were ready for flight, expected in late 1972, TsKBEM would use the older Kuznetsov engines."¹¹⁴

Apart from the engines, many other systems were reworked from 1969 to 1971. These included:

- Increasing the reliability of the oxidizer pumps (by increasing clearances and reducing the loads on bearings)
- Improving the quality of the manufacturing and assembly of the turbopump assembly
- Installing filters in front of the engine pumps to eliminate the entry of foreign objects
- Introducing the Freon fire extinguisher system
- Adding thermal protection elements into the instrumentation and cable system located in the tail section of the first stage
- Introducing blocking commands in the emergency engine shutdown system during the first fifty seconds of flight¹¹⁵

Furthermore, all piping in the NI's pneumo-hydraulic systems were still of the older flange pipe joint type. After the failure in July 1969, when engineers checked the already-manufactured and -tested units of another NI booster, they found that many of the flange joints with fluorine plastic seals had leaked after long periods of storage. In July and August 1969, engineers decided to replace the flange joints with automated welded ones—an extensive redesign procedure that was performed by the Moscow-based NII TekhnoMash (formerly NITI-40) organization. Since 1970, all pipelines in Soviet launch vehicles have been joined during integration assembly by automated welding."¹¹⁶

The work on improving the characteristics of the recalcitrant booster was concurrent with continuing work on the L3 complex. Because of a continuous redesign process on the two

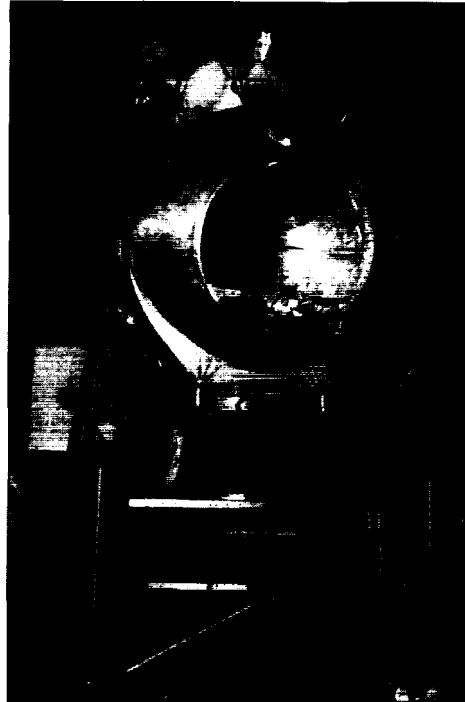

This ground model of the LK lunar lander is displayed at a museum in Kaliningrad (now Korolev) near Moscow. The four main landing legs are shown in retracted vertical position. The small spherical window at the upper center would have been used by the cosmonaut to observe the surface during landing. Sets of small attitude control engines can be seen near the top of the lander. (copyright Quest, via Luc van den Abeleen)

¹¹⁴ *Ibid* p 258 Dolgopyatov Dorofeyev and Kryukov "At the Readers Request The NI Project" Mozhzhorin et al eds *Dorogr v kosmos 1* p 129 Igor Afanasyev "NI Absolutely Secret" (English title) *Krylya rodiny* no 11 (November 1993) 4-5

¹¹⁵ Semenov ed *Raketno Kosmicheskaya Korporatsiya* p 258

¹¹⁶ Oleg E Ostrovsky and Valentin A Kazakov "Quality Provision for the Welded Joints of Pipelines for Space Rocket Complexes" *Space Bulletin* 2(2) (1995) 9-11 NITI 40 was headed by O Ye Ostrovskiy during the late 1960s

major components of the L3—the LK lander and the Lunar Orbital Ship (LOK)—neither component was ready for flight during 1969 and 1970. In the case of the LOK, sixteen ships had been originally ordered. Of these, by February 1970, seven had been manufactured, although only three were being ground-tested for future flight operations. As Mishin and his deputies stubbornly continued to pursue the old lunar landing plan, uncertainty in the mission profile continued to pervade the proceedings. In January 1970, six months after Apollo 11, engineers were still disagreeing about specifications of the Blok Ye engine for the LK lander. One of the major bottlenecks seemed to have been the components manufactured at the Arsenal Machine Building Plant in Leningrad. Engineers there faced many problems with tank production, thus missing deadlines for the delivery of the attitude control engines of the LK and the Engine Orientation Complex of the LOK. Consequently, there were changes in the powered descent profile of the lander, such as reducing the Blok D stage's deorbit operation time. In addition, they had still not adequately solved the question of mutual relationships among the LK, the LK_r (the reserve LK), and the Ye-8 rover. At a meeting of the TsKBEM leadership in May 1970, the prognosis was not good: although work on the NI was proceeding relatively well, work on the L3 was, by far, in the worst condition at the design bureau, behind in its schedules than many other unrelated projects. Funding for the NI-L3 program in 1970 was evidently short by about 60 million rubles.

As far as the lunar landing itself, Mishin had informed Minister Afanasyev of a provisional schedule of NI launches at a meeting in July 1970:

Date	Boosters	Missions	Engines
1970	6L, 7L	Automated lunar missions	Old engines
1971	8L, 9L, 10L	Automated lunar missions	Old engines
1972	11L, 12L, 13L	Piloted lunar-orbit missions	New engines
1973	14L, 15L, 16L	Two piloted lunar landings	New engines

The early automated flights would consist of robot variants of the LOK or LK or simply ballast, depending on what was available at the time. In the case of the LOK, the ships would carry special photographic equipment for imaging potential landing sites. Before an actual landing, it seems

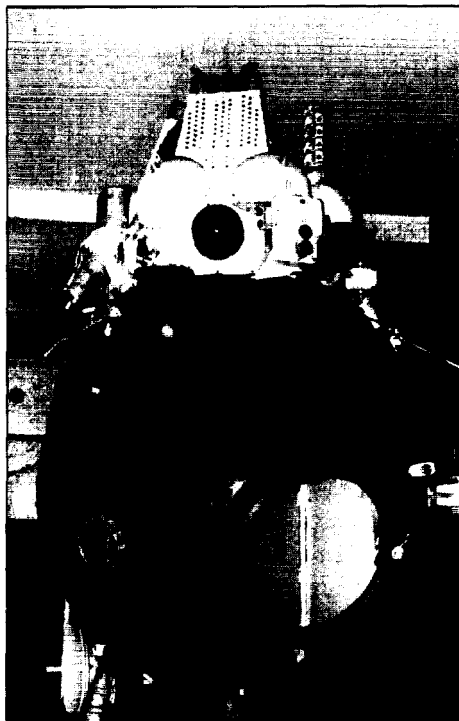

This is a close up of the spherical living compartment of a ground model of the LOK lunar orbiter on display at a museum. Note the slightly asymmetrical shape of the module significantly different from a standard Soyuz living compartment. The protrusion on the upper portion of the module is a porthole for a cosmonaut to directly observe rendezvous approaches with the LK lander. Attitude control thrusters similar to the ones on the LK are visible on the top left. The two small spherical protrusions on the top are propellant tanks for these engines. Curiously, the LOK living compartment seems to have been mounted on an L1 descent apparatus barely visible at the bottom of the photograph (copyright Quest, via Luc van den Abeleen)

that Mishin had planned a fully automated lunar landing and return flight. The veracity of these projections depended to a great extent not only on the fortunes of the NI but obviously on the flight rating of the L3 payload itself.

There was some good news in the L3 development program. Several vehicles were flown in 1970 that were directly part of the Soviet lunar exploration program. One of these was the 7K-LIE payload block, which consisted of a simplified 7K-LI circumlunar vehicle, an experimental Blok D stage, and the payload fairing. The Blok D stage, the primary payload, was equipped with supplementary sensors for transmitting more complete information on the internal processes of the stage during firings in Earth orbit. The stage had special transparent "portholes" through which the internal volume of the tanks was illuminated. During the maneuvers in Earth orbit, special cameras would photograph the movement of propellants.¹¹⁷ NASA had performed a very similar mission early on in the Apollo program during the mission of AS-203 in July 1966.¹¹⁸ The first launch attempt of the 7K-LIE, spacecraft no. 1, had been at 1200 hours Moscow Time on November 28, 1969, on top of a three-stage Proton booster. Because of a third-stage failure, the payload never reached orbit. U.S. intelligence assets clearly monitored the telemetry from the attempted launch as pieces of the suspect stage inadvertently fell on Chinese territory about 200 kilometers north of Harbin.¹¹⁹

It was yet another in an unprecedented series of failures of the Proton booster in 1969. It took more than a year to prepare a second LIE complex ready for launch. Spacecraft no. 2K was launched at 2000 hours Moscow Time on December 2, 1970. After reaching orbit, it was named Kosmos-382. Under the direction of TsKBEM Deputy Chief Designer Tregub, the Blok D stage was fired seven times in the course of six days in Earth orbit, simulating mid-course corrections, lunar orbit insertion, and powered descent from lunar orbit, thus rehearsing as closely as possible Blok D's nominal performance during an actual L3 lunar landing mission. All pertinent data on the stage's activities were transmitted successfully to Earth, adding significantly to confidence in the future use of Blok D.¹²⁰ During the mission, Western intelligence services were able to hear simulated voice transmissions from the spacecraft, prompting suggestions that the flight was related to a piloted project.¹²¹

Another L3-related precursor program was the flight of Earth-orbital versions of the LOK and the LK, designated the T1K and T2K, respectively. The original ambitious plans had been to fly these two spacecraft with crews on board to prove out both vehicles, much like the Apollo 9 mission flown a few months prior to the first lunar landing. Pressure from the Ministry of General Machine Building, in the form of financial restrictions, meant that Mishin had to completely eliminate flights of the T1K from the program: instead, the LOK would fly directly to the Moon on its first mission sometime in the future. The same fate probably would have befallen the T2K had it not been for intense pressure from Chief Designer Mikhail K. Yangel, whose organization, the Yuzhnoye Design Bureau (KB Yuzhnoye), created the main engine for the LK. Yangel's lobbying produced results, and Mishin was allowed to carry out three full flight tests of the T2K in Earth orbit in 1970-71—missions similar in many ways to the automated flight of the Lunar Module on Apollo 5.¹²²

¹¹⁷ Semenov, ed., *Raketno-Kosmicheskaya Korporatsiya*, p. 228.

¹¹⁸ Roger E. Bilstein, *Stages to Saturn: A Technological History of the Apollo/Saturn Launch Vehicles* (Washington, DC: NASA SP-4206, 1996), pp. 338-40.

¹¹⁹ E-mail correspondence. Vladimir Agapov to the author, September 30, 1996. For a Western report on the launch failure, see "Salyut Elements Separate, Signals Lost," *Aviation Week & Space Technology*, April 30, 1973, p. 21.

¹²⁰ Semenov, ed., *Raketno-Kosmicheskaya Korporatsiya*, p. 228.

¹²¹ See, for example, "Cosmos Changes," *Aviation Week & Space Technology*, December 21, 1970, p. 25; "Russian Moves," *Aviation Week & Space Technology*, May 3, 1971, p. 13.

¹²² V. Filin, "At the Request of the Reader: The NI-L3 Project" (English title), *Aviatsiya i kosmonavtika* no. 2 (February 1992) 40-41.

The T2K, while similar to the lunar version of the LK, was not identical to the latter. A number of systems necessary only for a real lunar landing were removed, while others necessary for testing were added. The most obvious difference was the omission on the T2K of the four landing legs comprising the Lunar Landing Unit with their stabilizing rocket engines. Engineers also removed the cosmonaut's ladder and two omnidirectional parabolic antennas on the rocket stage for deep space communications. As a substitute, a "weak" directional antenna was installed on the engine orientation compartment at the top of the lander. In addition, in place of the small suspended instrument compartment on the right side of the LK, designers added a large suspended compartment on the left side equipped with an ellipse-shaped cover. This compartment contained supplementary instrumentation for control and guidance, as well as an antenna system for radio control of the spaceship's maneuvers. The T2K also included an ionic orientation sensor instead of the standard adjusting and aiming sensors. On the pressurized cabin proper, there was also an additional telemetry antenna. The spaceship itself was equipped with a special control system capable of complete automated flight. The total launch mass of the T2K was around 5.7 tons, low enough to be launched by a modified variant of the Soyuz booster named the 11A511L. The rocket had an unusual "large-caliber" payload fairing to accommodate the spaceship."

The flight program of the T2K was directed by yet another State Commission, this one headed by Maj. General Aleksandr A. Maksimov, the Deputy Commander of the Chief Directorate of Space Assets of the Strategic Missile Forces. One of Maksimov's more notable career duties had been service as the secretary of the State Commission for the R-7 ICBM and the early Sputnik launches during the 1950s. The T2K series would consist of three missions. The first flight would simulate a routine lunar landing, while the second and third would simulate potentially anomalous situations during a landing. About twenty primary systems would be monitored on each mission. In attendance for the first launch were Korolev's second wife Nina Ivanovna Koroleva and his daughter Natasha, who were at Leninsk for the opening of a new memorial in Korolev's honor.

The first T2K, vehicle no. 1, lifted on November 24, 1970, at 1400 hours Moscow Time and entered a 191- by 237-kilometer orbit inclined at 51.61 degrees. The spaceship was named *Kosmos-379* by TASS; there was no hint that the flight had any relation to the piloted space program. After a thorough check of the on-board systems, at 0744 hours on November 25, controllers fired the main T2K engine under heavy throttling to simulate a landing on the lunar surface, including a "hover" phase. The resulting orbit was 192 by 1,210 kilometers at 51.65 degrees. Once again, controllers performed various checks of the T2K as it "rested on the Moon" for a day and a half. Finally, on November 27 at 1859 hours, the Lunar Landing Apparatus (the descent stage) was jettisoned, and the main engine fired once again, this time at maximum thrust, simulating a liftoff and entry into lunar orbit. After this maneuver, orbital parameters were highly elliptical: 177 by 14,041 kilometers at 51.72 degrees. The vehicle spent some subsequent time in stabilization mode to simulate maneuvers for rendezvous and docking with the LOK before the mission was declared a complete and unequivocal success."

The momentum of this rare success in the piloted lunar program extended to the two remaining tests of the T2K. The second test was to simulate an aborted landing on the Moon. The spacecraft, named *Kosmos-398* upon entering Earth orbit, was launched at 1514 hours Moscow Time on February 26, 1971. Initial orbital parameters were similar to the earlier ship: 191 by 258 kilometers at a 51.61-degree inclination. After two days in orbit, the Blok Yé main engine was fired at 0721 hours on February 28, simulating a landing attempt. After this, the descent stage was jettisoned, and the primary engine fired once more to insert the vehicle in its final orbit at 200 by 10,905 kilometers at a 51.59-degree inclination. Once again, the mission was flawless. The third and final test of the T2K was almost six months later. The ship, named

123. K. Lantratov, "The Fall From Orbit of the Last Soviet Lunar Ship" (English title), *Novosti kosmonavтики* 25 (December 3-16, 1995), 32-36; Afanasyev, "Unknown Spacecraft."

124. *Ibid.*

Kosmos-434. was launched at 1250 hours Moscow Time on August 12, 1971, into an initial orbit of 189 by 267 kilometers at a 51.60-degree inclination. On this mission, the goal was slightly different: to use only the backup engine for liftoff "from the Moon." assuming that the primary one had failed. Less than a day after launch, at 0634 hours on August 13, the primary engine was fired, for the longest time on any of the missions, simulating a landing on the Moon. The new orbital parameters were 190 by 1,261 kilometers at the same inclination. Kosmos-434 remained static "on the Moon" for more than three days before using its reserve engine at 0840 hours on August 16 to fire into a new orbit of 186 by 1,804 kilometers at a 51.54-degree inclination. The second firing had been planned for an earlier time, but had to be delayed because of some minor technical problems, which did not detract from the completion of a successful mission."¹²⁵

At the time of these apparently mysterious missions, Western observers closely monitored the orbital changes, concluding that the flights were part of a renewed Soviet effort to land cosmonauts on the Moon.¹²⁶ One of the more interesting postscripts to the T2K missions was the demise of Kosmos-434. In the summer of 1981, when the spacecraft was about to reenter, there were intermittent reports in the West that Kosmos-434 was a satellite with nuclear materials aboard, thus posing a threat to any people living over its descent track. The vehicle eventually reentered over Australian territory and fell harmlessly into the sea off the coast of China. To allay continuing fears, a spokesperson from the USSR Ministry of Foreign Affairs assured the Australian government on August 26, 1981, that the satellite did not carry any nuclear materials because it was "an experimental lunar cabin" with no "energy source."¹²⁷ Because "lunar cabin" was the term the Soviet press normally had used to describe the Apollo Lunar Module, the statement was a major landmark: it was the first official, albeit oblique, confirmation that the Soviet Union built hardware designed to land cosmonauts on the Moon.

The successful missions of the LIE and the T2K were significant morale boosters to the many thousands of engineers engaged in a program that had evinced few fruitful results. Firm commitments on a date for the lunar landing were fixed several times throughout 1970 and 1971. The original schedule produced by Mishin in July 1970, however, proved to be too optimistic. The launch date of the next N1 (booster 6L) was delayed primarily because of new concerns about discrete vibrations at launch. In addition, Mishin decided to begin using the new and improved Kuznetsov engines much earlier than planned (on booster 8L), requiring that rocket to be sent back to the plant for extensive redesign. The new schedule, truncated from before and prepared in September 1970, looked like this:

Date	Boosters	Missions	Engines
1971	6L, 7L	Automated lunar missions	Old engines
1972	8L, 9L, 10L	Automated and piloted lunar missions	New engines
1973	11L, 12L, 13L	Piloted lunar landings	New engines
1974	14L, 15L	Piloted lunar landings	New engines ¹²⁸

¹²⁵ *Ibid.*

¹²⁶ See, for example, Richard D. Lyons, "Experts Say Russia Plans Manned Landing on Moon," *New York Times*, September 6, 1971, pp. 1, 33; Donald C. Winston, "Soviets Prepare for Manned Moon Landing," *Aviation Week & Space Technology*, March 8, 1971, pp. 43-46. "Recent Cosmos Believed Advanced Hardware," *Aviation Week & Space Technology*, March 15, 1971, p. 18; "Russian Moves," *Aviation Week & Space Technology*, May 3, 1971, p. 13.

¹²⁷ Robert Gillette, "Soviets Hint 'Experimental' Fallen Satellite Lost Its Way to Moon," *Washington Post*, August 30, 1981, p. A25.

¹²⁸ The first piloted lunar landing would use a second booster, probably the unflown booster 4L, to launch the reserve LK known as the LK. See K. Lantratov, "Anniversaries: The 'Deceased' Lunar Plan" (English title), *Novosti kosmonavtiki* 14 (July 2-15, 1994): 60-61.

CHALLENGE TO APOLLO

The final launches in 1974 would officially end the N1-L3 program, at the same time that more advanced lunar missions, still in the early stages of planning in 1970, would begin in 1974. Mishin personally briefed Soviet leader Brezhnev with this schedule at a meeting in October 1970. Even at this late date, Mishin continued to appeal to Brezhnev to commit to funding to build a full-scale static test stand for the N1 first stage, but these entreaties fell on deaf ears. If Mishin's promised schedule was met, however—and it seemed a fairly realistic assessment given the current pace of operations—then a Soviet cosmonaut would finally land on the Moon sometime in 1973, four years after Apollo 11.

The Scooper Comes Home

The untimely failure of Luna 15 during that historic week in July 1969 had not discouraged the design bureau at the S. A. Lavochkin State Union Machine Building Plant at Khimki in pursuing its primary objective of using the Ye-8-5 robotic spacecraft to recover lunar soil and bring it back to Earth. Although the unusually high stress of the summer of 1969 had evaporated, the pressure never completely disappeared. Because one of the new public doctrines of the Soviet space program was the automated exploration of the Moon. Chief Designer Georgiy N. Babakin had the dubious role of serving to fit the needs of the Soviet propaganda by delivering a successful sample return mission. The first attempts to do so after the July 1969 debacle were in the fall of 1969. On September 5, 1969. Maj. General Tyulin, the chair of the State Commission for the Ye-8 series of probes, reported that the central cause of the Luna 15 failure had still not been determined by engineers. Despite the gap in data. Tyulin opted to launch another scooper, the third in the series, on September 23.¹²⁹

Ye-8-5 probe no. 403 was launched from site 81 at Tyura-Tam at 1700 hours Moscow Time on September 23, 1969. The Proton booster successfully inserted the payload into Earth orbit. but the Blok D translunar-injection stage failed to fire a second time to impart Earth escape velocity to the probe. Telemetry the following day indicated that a fuel injection valve had evidently become stuck during the first firing of Blok D to insert the payload into Earth orbit, and all the liquid oxygen had been sucked out before the second firing. Remaining as an inert payload in Earth orbit, the Soviet press quietly designated the satellite as Kosmos-300 and promptly forgot about it. Ground controllers evidently attempted to control the descent of the probe for about four days, but the spacecraft eventually reentered harmlessly over the oceans. A second try came less than a month later. Ye-8-5 probe number 404 was launched on October 22 and successfully entered Earth orbit. After an hour, when the Blok D engine was timed to fire, the readings abruptly went off the scale, and communications were interrupted. For two hours, the flight control team attempted to regain communications, before finally receiving a report from the Kamchatka tracking station that not only had the probe not left Earth orbit, but that it had reentered and fallen in the ocean near Australia. This time, there was a failure in one of the radio-command blocks. Apparently a "minus" sign had not been removed from a program to command the guidance system for the firing." The stranded probe was named Kosmos-305.

¹²⁹ Kamanin. "I Feel Sorry for Our Guys," no. 13

¹³⁰ K. Lantratov. "The 'Late' Lunar Soil" (English title). *Novosti kosmonavtiki* 15 (July 16–29, 1994). 41–43; Kamanin. "I Feel Sorry for Our Guys," no. 14; O. A. Sokoiov. "The Race to the Moon: A Look from Baikonur." presented at the 45th Congress of the International Astronautical Federation. IAA-94-2.1.610. Jerusalem, Israel, October 9–14, 1994. Note that the description of the failure given in the last source probably refers to Kosmos-305 and not Kosmos-300, as indicated by the author.

Trudging on, Babakin's engineers prepared the fifth sample returner. Ye-8-5 probe no. 405, for a launch in early 1970. The launch went off on February 6, 1970, but 126 seconds into the flight, the first stage exploded, destroying any hopes of a success." Clearly, one of the bottlenecks in the program was the performance of the UR-500K Proton launch vehicle. Its record during 1967-70 had been perhaps one of the most dismal in the record of any launch vehicle developed by any spacefaring nation. Out of nineteen launches of the four-stage variant of the Proton booster up until February 1970, ten had completely failed to deposit their payloads into orbit, three had reached orbit but failed to send their payloads to escape velocity, and only the remaining six had been completely successful:

No.	Launch Date	Payload	Mission	Result
1	March 10, 1967	7K-L1/Zond	Kosmos-146	Success
2	April 8, 1967	7K-L1/Zond	Kosmos-154	Blok D failure
3	September 28, 1967	7K-L1/Zond		Stage I failure
4	November 22, 1967	7K-L1/Zond		Stage II failure
5	March 2, 1968	7K-L1/Zond	Zond 4	Success
6	April 23, 1968	7K-L1/Zond		Stage II failure
7	September 14, 1968	7K-L1/Zond	Zond 5	Success
8	November 10, 1968	7K-L1/Zond	Zond 6	Success
9	January 20, 1969	7K-L1/Zond		Stage II failure
10	February 19, 1969	Ye-8/Luna		Shroud failure
11	March 27, 1969	M-69/Mars		Stage III failure
12	April 2, 1969	M-69/Mars		Stage I failure
13	June 1, 1969	Ye-8-5/Luna		Blok D failure
14	July 13, 1969	Ye-8/Luna	Luna 15	Success
15	August 7, 1969	7K-L1/Zond	Zond 7	Success
16	September 23, 1969	Ye-8-5/Luna	Kosmos-300	Blok D failure
17	October 22, 1969	Ye-8-5/Luna	Kosmos-305	Blok D failure
18	November 11, 1969	7K-L1E/Kosmos		Stage III failure
19	February 6, 1970	Ye-8-5/Luna		Stage I failure

In fact, if there was any one reason why the coveted L1 circumlunar program had achieved success so late, it was Chelomey's Proton rocket. The failures were so glaring that after the secret February 1970 launch failure, some Western observers were claiming, correctly so, that the Proton was a severe bottleneck in Soviet space ambitions."

Babakin was naturally concerned about the Proton's record. In March 1970, he met with Minister of General Machine Building Afanasyev and asked him to stipulate that Chelomey address the dismal record of the rocket and make necessary changes. For his part, Chelomey's design bureau undertook a short development program to requalify the booster, especially its first and third stages. As part of this effort, on August 18, 1970, at 0645 hours Moscow Time, TsKBM launched a three-stage UR-500K rocket on a suborbital mission to verify certain systems of the launch vehicle." The flight, named 82EV, was evidently successful, as

131 N G Babakin A N Banketov and V N Smorkalov *Č N Babakin zhizn i deyatelnost* (Moscow Adamant 1996) p 66

132 See for example Stewart Alsop "Salt and Apollo 13" *Newsweek* (April 27 1970) 112 According to the source the Soviets had spent about \$2 billion on the Proton program up to 1970

133 Agapov correspondence September 30 1996, Babakin Banketov, and Smorkalov *Č N Babakin* p 86

space-related Proton launches finally resumed the following month after a long gap. In fact, the record of Proton flights following August 1970 showed a dramatic improvement, with failures becoming an occasional rarity.

The sixth scooper probe, Ye-8-5 no. 406, was launched at 1626 hours Moscow Time on September 12, 1970, into a parking orbit around Earth. First Deputy Minister of General Machine Building Tyulin once again served as chair of the State Commission. About seventy minutes after entering orbit, the Blok D stage fired to boost the payload toward the Moon. There was a short mid-course correction the following day before the spacecraft, named *Luna 16*, successfully flew into lunar orbit on September 17 using the 11D417 engine. The orbit was circular at an altitude of 110 kilometers at a 70-degree inclination to the lunar equator. There were two planned burns to adjust the orbit on September 18 and 19, the final firing leaving *Luna 16* in a low elliptical orbit at fifteen by 106 kilometers at 71 degrees. The landing approach began as soon as the ship reached its low perigee. Unlike the Apollo Lunar Module, which followed a complex shallow approach to the landing site, the Ye-8-5 ship simply fired the main engine to cancel orbital velocity, causing a drop toward the surface, and then performed a final burn to ensure a soft-landing. The spacecraft's on-board control system fed attitude and altitude information into the internal gyro, and the ship's two side units were cast off just before commencement of the descent to the Moon. The engine fired for about 270 seconds, beginning at 1112 hours on September 20. The free-fall itself followed a preprogrammed instruction set modified by radar altimeter information on altitude and rate of descent. At a height of 600 meters, with the spaceship falling at a rate of 700 kilometers per hour, the on-board computer fired the main engine again. The engine cut off at twenty meters, prompting the two smaller engines to ignite to complete the descent. *Luna 16* landed safely in the northeast portion of the Sea of Fertility about 100 kilometers east of the Webb crater. The landing velocity was nine kilometers per hour.¹³⁴

Two cameras similar to the ones used on the earlier Ye-6 landers were installed on the main instrument section to swivel and return facsimile stereo images of the area between the ship's two landing pads to determine a precise spot for obtaining a sample. The spacecraft, however, landed in an area not illuminated by the Sun, and it is probable that the cameras were of no use. The hollow rotarypercussion bit, a hollow cylinder with cutters on the edge, was driven thirty-five centimeters into the surface for a seven-minute period to capture a small soil sample. During this phase, ground controllers were alarmed when telemetry information showed that soil resistance to the drill increased with depth, and then abruptly decreased, raising the possibility of a broken drill. Luckily, there was no damage, although Tyulin's team at Yevpatoriya terminated drilling at that point. The boom then lifted the sample to the open hatch of the small spherical return apparatus. Evidently, a significant amount of soil dropped out of the scooper during this upward movement. The total amount in the capsule was 105 grams. At 1043 hours on September 21, after more than a day on the surface, the ascent stage of *Luna 16* fired its S5.61 engine to lift itself on a direct return trajectory to Earth. Roll thrusters provided spin control during the trip, ensuring proper thermal regulation. The remaining portion of *Luna 16* continued to return data on local temperature and radiation conditions.

Straps holding the return apparatus to the ascent stage were severed at 0450 hours on September 24 at a distance of 48,000 kilometers from Earth. While the ascent stage burned up over Earth, the spherical capsule hit the atmosphere vertically at thirty degrees, traveling at eleven kilometers per second. As temperatures reached an incredible 10,000 degrees Centigrade, the capsule decelerated at up to 350 g's; a signal from a barometer commanded the

¹³⁴ Andrew Wilson, *Solar System Log* (London: Janes Publishing Co., 1987), p. 60-61. The exact landing coordinates were 0° 41' S and 56° 18' E. See *Soviet Space Programs 1966-70*, p. 198.

ejection of the top of the sphere at an altitude of fourteen and a half kilometers, thus unfurling the drogue parachute. The main parachute and four beacon antennas deployed at eleven kilometers. The capsule landed safely at 0826 hours, about eighty kilometers southeast of the town of Dzhezkazgan in Kazakhstan. After a trip to the Moon and back, the landing was only thirty kilometers from the projected target.¹³⁵

This first recovery of soil from a planetary body by automated means was an outstanding accomplishment and a tribute to the ingenuity of Soviet engineering expertise. State Commission Chairman Tyulin recalled later that "the emotional strain on the State Commission and the technical leadership, as well as on all of participants of this unusual operation, was clearly noticeable, especially over the last 12 days." but that when the signals were received confirming a safe return of Luna 16, there was "boundless rejoicing" at the Flight Control Center.¹³⁶ Rescue teams located the capsule within minutes of the landing. They removed the soil container, which was flown to Moscow. There it was unsealed in a sterile chamber filled with inert helium. The analysis of the soil, performed by the V. I. Vernadskiy Institute of Geochemistry and Analytical Chemistry's Laboratory of Comparative Planetology, showed the composition of the dark powdery basalt material to be very similar to samples returned on Apollo 12 in November 1969. In June 1971, three grams of the Luna 16 sample were forwarded to NASA as part of a scientific agreement in exchange for three grams from the Apollo 11 samples and three grams from the Apollo 12 collection."¹³⁷

The success of Luna 16 raised the inevitable comparisons with the Apollo program. Soviet commentators naturally made much of their recent accomplishment. Academician Boris N. Petrov told TASS on September 24 that automatic exploration cost one-twentieth to one-fiftieth as much as piloted space exploration. TsKBEM Department Deputy Chief Raushenbakh was more specific in his comparisons, suggesting on September 28 that the cost of the samples returned by Luna 16 were considerably less than those brought back by the Apollo mission. While the two programs are difficult, if not impossible, to compare, it is a fact that the two Apollo missions up to that point had returned a far greater amount (sixty kilograms) of lunar rocks and soil than Luna 16 (0.105 kilograms). Based on the per capita cost of a kilogram of lunar soil from the Luna mission versus the Apollo missions, there is no doubt that the latter were far superior. But the amount of lunar soil returned is clearly poor measure of the true scientific value of a mission. In purely scientific terms, the U.S. astronauts conducted a wide array of experiments on the surface while Soviet controllers were extremely limited in their choice of research. The Apollo astronauts, for example, had a much greater ability to choose particular samples from a very large area compared to Luna 16. Finally, the costs of Apollo were associated with numerous intangible benefits—primarily associated with prestige—which clearly cannot be measured in the traditional sense. Luna 16 was certainly a remarkable technological accomplishment, but it was probably not, as Soviet officials of the day touted, a "cheaper and better" alternative to Apollo.

Luna 16 was followed, also in 1970, by another equally impressive achievement in the Soviet lunar exploration program: the flight of the Ye-8 lunar rover, which was named *Luna 17*. Incorporated into the L3 piloted lunar landing plan, the rover effort had by then assumed a life of its own. The first attempt to launch the mobile crawler had failed in February 1969. It was

135 Wilson, *Solar System log*, pp. 61–63, Sokoiov. "The Race to the Moon": N. Karnanin. "I Feel Sorry for Our Guys" (English title), *Vozdushniy transport* 15 (1993): 12.

136 Mozzhorin, et al., eds., *Dorogi v kosmos*: I, p. 164.

137. Elizabeth K. Newton, A Preliminary Study of the Soviet Civil Space Program. Volume I *Organization and Operations* (Pasadena, CA: Jet Propulsion Laboratory, JPL D-7513, 1990), pp. 3–4, 33–34. Wilson, *Solar System log*, p. 63.

138 *Soviet Space Programs, 1966–70*, p. 383.

almost two years before the second flight model, spacecraft no. 203, was ready for launch. At 1744 hours Moscow Time on November 10, 1970, a four-stage Proton lifted off and injected the spacecraft toward the Moon soon after. Following two mid-course corrections on November 12 and 14, Luna 17 entered orbit around the Moon on November 15. The parameters were eighty-five by 141 kilometers. The following day, the perigee was lowered to nineteen kilometers. The spacecraft deorbited and safely landed at 0646 hours, 50 seconds Moscow Time on November 17 in an ancient crater in the Sea of Rains. The landing profile was identical to that used on Luna 16. Two sets of ramps were lowered, and the five-person steering team at Yevpatoriya in Crimea commanded the strange-looking eight-wheeled robot down to the surface about an hour and a half after touchdown. Contact with the Ye-8 lunar rover, called Lunokhod I in the Soviet press, was limited to about six hours a day when the Moon was above Earth's horizon."¹³⁹

Among the scientific experiments aboard Lunokhod I was a penetrometer to test the soil's mechanical characteristics, which was used more than 500 times during the rover's sojourn. The *Rifma* x-ray fluorescence spectrometer, used about twenty-five times, was used to irradiate soil and record induced radiation to identify quantities of different elements. Adding a slightly international flavor to the mission, Lunokhod I also carried a three-and-a-half kilogram French-supplied instrument above the forward cameras, consisting of fourteen ten-centimeter silica glass prisms to bounce back pulses of ruby laser light fired from observatories in Crimea and France. Scientists first used this reflector on December 5 and 6, allowing the Earth-Moon distance to be measured down to an accuracy of thirty centimeters. Similar instruments, with less reflective capacity, were also carried on the Apollo landing flights. There was also an x-ray telescope and a gamma spectrometer on the spacecraft. Lunokhod I, the first mobile vehicle to travel on the surface of another planetary body, had an initial design life of three lunar days (about twenty-one Earth days), but in fact operated for eleven lunar days (about seventy-seven Earth days). Tyulin's team commandeered the rover across 197 meters during the first lunar day, peaking on the fifth by covering 2,004 meters between March 7 and 20, 1971. Steering through the lunar landscape was evidently very difficult for the control team, primarily because of the six-second delay between the command and the execution of a maneuver.¹⁴⁰

The crawler's remarkable journey came to an end at 1605 hours Moscow Time on September 14, 1971, when the last communications session was finished. The day after, TASS reported that the internal temperature of the rover had fallen because of decay of the nuclear heater during the night. For several days, controllers tried to reestablish contact with Lunokhod I, but with no success, and all attempts to do so were terminated on October 4. Lavochkin Deputy Chief Designer Ivanovskiy, one of the principal architects of the mission, later recalled that the rover's internal batteries had been designed for only a certain number of cycles of charging and recharging, equivalent to three months. After exceeding their design lifetimes by almost eight months, the batteries simply gave up. Ultimately, the mission had been an outstanding success. Lunokhod I had covered an area of 80,000 square meters and taken 20,000 photographs and 206 panoramas of the lunar surface. During its 301-day, six-hour, and thirty-seven-minute mission, it had traveled 10,540 meters. It had crossed craters, climbed inclines, observed solar eclipses, and even found its way back to its mother stage in January 1971, taking one of the more impressive photos of the mission—a beautiful shot of Luna 17

139 Wilson, *Solar System Log*, p. 63; Konstantin Lantratov, "Anniversaries: 25 Years From Lunokhod-I" (English title), *Novosti kosmonavtiki* 24 (November 19–December 2, 1995): 70–79. The five-person team was part of a larger eleven-member team of N. Yeremenko and I. Fedorov (commanders), G. Latypov and V. Dovgan (drivers), K. Davidovskiy and V. Samal (navigators), L. Mosenzov and A. Kozhevnikov (engineers), V. Sapranov and N. Kozlitsin (omnidirectional antenna operators), and V. Chubukin (reserve driver and operator). The landing coordinates for Luna 17 were 38° 17' N, 35° 00' W.

140 Wilson, *Solar System Log*, pp. 63–64; Lardier, *L'Astronautique Soviétique*, p. 269

with its ramps lowered to the lunar surface. For ten months, it had withstood temperatures ranging from the intense cold of the lunar night (minus 150 degrees Centigrade) to the searing heat of the lunar day (over 100 degrees). Before losing contact, the controllers had managed to park the rover so that the laser reflectors remained in a usable position.¹⁴¹

Both the Luna 16 and Luna 17 missions were not only important scientific and technological achievements in their own right, but they also added weight to Soviet claims of the benefits of automated over piloted lunar exploration. It was only fitting that a third robotic lunar flight in 1970, the very last gasp of the L1 piloted circumlunar program, was sandwiched between the Luna 16 and Luna 17 missions. Although the circumlunar project had long since lost its political utility, there was still hardware remaining, specifically three flight-ready 7K-L1 vehicles. Piloted flights in the series had been suspended in the spring of 1969, but Mishin had doggedly pursued the idea of launching a crew regardless of the decisions from above. His view did have some rationale; the entire circumlunar system, the 7K-L1 vehicle, Blok D, and the Proton booster were, by mid-1970, ready for piloted flight. Such a mission, perhaps even multiple missions, would provide valuable experience in mounting more complex crewed lunar operations in the future. But the pressure not to do so was intense, and he eventually abandoned the idea. As a compromise, he was allowed to continue automated technological flights. Thus, in the fall of 1970, TsKBEM prepared one final L1 ship, spacecraft no. 14, to fly around the Moon.

The vehicle was launched at 2255 hours, 39 seconds Moscow Time on October 20, 1970, a month after the recovery of lunar soil samples by Luna 16. Following the standard checkout in parking orbit around Earth, the ship, called Zond 8, headed for the Moon. The flight trajectory of the spaceship differed with respect to earlier Zonds because, on this mission, engineers planned to use a different reentry profile—one in which the spacecraft would fly in over the Northern Hemisphere instead of the South Pole. Such a profile would allow ground stations on the contiguous Soviet territories to control most portions of the flight; in addition, the profile "was more advantageous in terms of power consumption and ensured a more precise splashdown."¹⁴²

The day after launch, during the trip to the Moon, scientists at the Shternberg Astronomical Institute, at an observatory in the Zaylinskiy Altay, photographed the spacecraft against the stellar background, partly to confirm the accuracy of its trajectory. Photomultiplier tubes allowed identification of the ship, which was 328,000 kilometers from Earth at the time. Zond 8 itself photographed Earth on October 21. Besides cameras, the spacecraft carried unshielded aluminum foil "targets" similar to those on the Apollo solar wind collector packages. These were mounted on the outside of the descent apparatus to detect the isotropic composition of the solar wind. There was one mid-course correction at a distance of 250,000 kilometers on the following day, allowing the spacecraft to circle the Moon on October 24 at a minimum distance of 1,200 kilometers. The standard black-and-white and color photographs of the lunar surface were taken at distances of 9,500 and 1,500 kilometers. On the way home, there were two further mid-course corrections to sharpen its trajectory for the new reentry profile. Ground stations within the Soviet Union were able to control the dynamics of reentry as the Zond 8 descent apparatus flew over the North Pole during a ballistic reentry. It eventually splashed down 730 kilometers southeast of the Chagos Islands, in the Indian Ocean, at 1655 hours Moscow Time on October 27. The landing was only twenty-four kilometers from the intended target—and twelve kilometers from the nearest ship, a Soviet oceanographic vessel named the *Taman*, which picked up the capsule fifteen minutes later. Rescuers then transferred the vehicle to the Semyon *Chelyuskin*, which took it to Bombay, India, from where it was flown to Moscow.¹⁴³

141 Lantratov. "Anniversaries 25 Years From Lunokhod-1"; Wilson, *Solar System log*, p. 64

142. Mishin. "Why Didn't We Fly to the Moon?"

143 Glushko, ed., *Kosmonautika entsiklopediya*, p. 130, Gatland, *Robot Explorers*, 150-51; Semenov, ed., *Raketno-Kosmicheskaya Korporatsiya*, p. 246. Soviet Space Programs, 1966-70, pp. 244-45; Joel Powell, "Research From Soviet Satellites," *Spaceflight* 25 (January 1983): 33-34. One source states that originally a guided reentry was planned, but because of a failure in an attitude control sensor, the vehicle performed a direct ballistic reentry. See Afanasyev, "Unknown Spacecraft."

The L1 program was finally over. Started by the late Korolev in 1965, it was originally to have been a symbol of Soviet power during the celebrations for the fiftieth anniversary of the Great October Revolution in 1967. But after eleven launches and billions of rubles, the program receded into the background as an example of how politics, poor planning, a terrible launch vehicle, and bad luck could sabotage even the best of intentions. The results were, of course, not all bad. TsKBEM had performed two fully successful (Zond 7 and Zond 8) and two partially successful (Zond 5 and Zond 6) automated circumlunar missions. Much of the technology and expertise cultivated during the project were invaluable for the well-being of more ambitious efforts, such as the L3 landing program. An official history of the Zond program rightly notes a remarkable list of technical accomplishments from the project, but ultimately does not shirk from listing the most glaring omission: that no L1 spacecraft was ever flown with a crew on board.¹⁴⁴ It is, however, undeniable that had the Soviets chosen to fly a crew around the Moon in 1970, they could have. TsKBEM still had two flightworthy vehicles remaining. But as Mishin noted twenty years later:

... as a result of a decision by the higher authorities, the circumlunar flight by two cosmonauts in the UR-500K-L1 program did not take place, despite the fact that the material base and the cosmonauts for the flight were ready. This decision resulted from the fact that the United States had already taken the lead from us in that direction. I feel that the decision was erroneous and that it did not take into consideration the opinion of the rank-and-file people and specialists who had labored heroically to execute the program. . .

The Zond program took its place in history as yet another Soviet space program that was unfulfilled in its dreams.

¹⁴⁴ Semenov ed. *Raketno-Kosmicheskaya Korporatsiya* pp 246–47

¹⁴⁵ Mishin "Why Didn't We Fly to the Moon?"

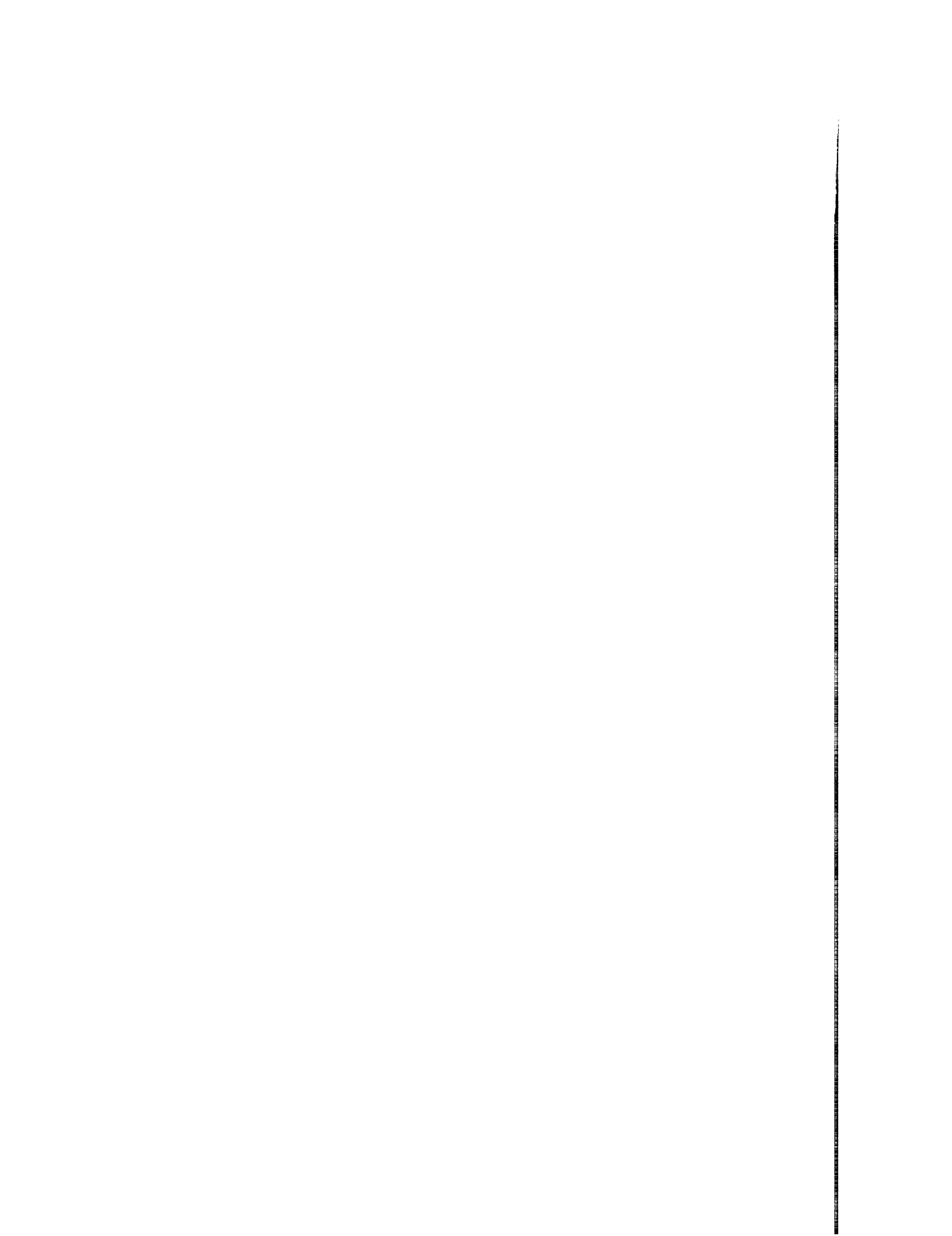



CHAPTER SEVENTEEN

DREAMS UNFULFILLED

Following the Soviet drive to reach the Moon during the Cold War is like chasing a trajectory that turns and twists at the least expected moments, often splintering into multidirectional paths, each road with its own story of triumph, tragedy, and irony. In 1969, the Soviet lunar program was at a crossroads and split into three distinct options for Soviet planners: the space station in Earth orbit, expanded lunar landing missions, and a Mars landing project. The Mars option was the most ambitious element of this triad, and the fact that it existed at all is testament to the often unrealistic ambitions of both space industry officials and the chief designers.

Aelita

One of the first Soviet-era science fiction novels was published in 1923. Authored by the well-known prose writer Aleksey N. Tolstoy, the novel was a narrative on the adventures of two Russian cosmonauts on the surface of Mars, a planet governed by a ruthless emperor. The novel, named *Aelita* after its main character, the "Queen of Mars," was later turned into a movie of the same name, and it eventually became a widely popular film that was part of the cultural vernacular of the 1920s.¹ When the time came in 1969 to assign a cover name to the new Soviet Mars program, officials chose Aelita. Piloted expeditions to Mars had, of course, been part of exploratory studies in the Soviet Union well before 1969. Ten years earlier, a team under Maksimov at OKB-1 had begun research on the so-called Heavy Interplanetary Ship for flight around Mars and back. Another team, led by Feoktistov, studied a concept for landing a crew on Mars in a larger vehicle, also called the Heavy Interplanetary Ship. None of these studies had official sanction or funding from the Communist Party and government, but Chief Designer Korolev was sufficiently engrossed in the idea to assign a permanent team to study the problem. In the autumn of 1964, he established Department No. 92 under Ilya V. Lavrov to specifically study the prospects for a piloted Mars landing mission.²

As the N1-13 program gathered steam during the mid-1960s, the work on the Heavy Interplanetary Ship moved ever so slowly to the sidelines. Still, Korolev managed to maintain his commitment to the idea and was particularly interested in the closed-loop life cycle systems that would be necessary for the long trip to Mars. Some of this research was carried out at the

¹ Peter A. Gorin, "Rising From a Cradle: The Evolution of Public Perception of Spaceflight in Russian Prior to Sputnik," presented at the conference "Reconsidering Sputnik: 40 Years Since the Soviet Satellite," Washington DC, September 30–October 1, 1997.

² Yu. P. Semenov, ed., *Raketno-Kosmicheskaya Korporatsiya "Energia" men' S. P. Koroleva* (Korolev RKK Energiya, named after S. P. Korolev, 1996), p. 168.

Physics Institute of the Siberian Department of the Academy of Sciences at Krasnoyarsk. Legend has it that two of the young scientists working on the problem once met with Korolev and offered him water regenerated by chlorella from human urine. The chief designer declined the offer, but remained very interested in the problem. The same institute designed a closed biosphere designated *Bios-1*, which was first tested by Iosif I. Gitzelzon, a thirty-five-year-old medical doctor who had been one of the men who had met with Korolev.³ Other organizations were also involved in the overall research. The Tomilino-based KB Zvezda designed one version of a system for the spacecraft in which food consisted of sublimated provisions based on two criteria: high nutrition value and low specific mass. A small hydroponic hothouse equipped with external solar concentrators would be used for additional nutrition.

Eventually by the late 1960s, presumably to optimize all work on Martian spacecraft, the two different Heavy Interplanetary Ship designs were unified into one, the Feoktistov proposal. A special ground test simulator for the ship was built after Korolev's death, and it was there on November 5, 1967, that three men—physician German A. Manovtsev (group leader), biologist Andrey N. Bozhko, and technician Boris N. Ulybyshev—entered the laboratory complex for a simulation of a long-duration piloted spaceflight. The team used water and oxygen regenerated from body waste, including urea, transpiration moisture, and exhaled carbon dioxide. For food, the researchers used freeze-dried food and green vegetables grown in a ground-based greenhouse. The greenhouse used simulated sunlight and ion-exchange resins saturated with nutrient substances instead of soil. Solid biological waste was simply removed from the cabin. They finally exited on November 5, 1968, a year after their entry.⁴

The work on the Heavy Interplanetary Ship slowed down after Korolev's death, but with the renewed interest in Mars after Apollo 8, these studies assumed an increased importance. Coincidentally or not, in 1969, TsKBEM issued an "experimental design" of a piloted Martian landing spacecraft, the most detailed technical description yet of such a vehicle. Spurred by the abrupt interest from Ustinov and Afanasyev to pursue a Mars project, engineers could be forgiven for hoping that this design would see the light. The ship, now called the Martian Expeditionary Complex (MEK), consisted of:

- An interplanetary orbital ship carrying the crew and primary on-board systems
- A Martian landing ship for landing on the surface of Mars
- A return apparatus for flight to Earth in which the crew would reenter Earth's atmosphere
- Powerful engine units with nuclear reactors and electric rocket engines

The basic requirements for the 1969 mission were to carry out a Mars landing during a 630-day (or 1.7-year) mission, with thirty days spent orbiting Mars. A total of six cosmonauts would be aboard the ship; three of them would spend at least five days on the surface. The primary propulsion system on the Martian ship would be electric rocket engines using nuclear power sources for the main part of the journey and liquid-propellant rocket engines for operations near Mars.⁵

³ V Nelyubin "Three Flights to Mars Soviet Cosmonauts Made Them in the Early 1960s Without Leaving the Earth" (English title) *Komsomolskaya pravda* January 15 1992 p 4 The other doctor who offered Korolev the recycled sample was I Terskov

⁴ G V Petrovich ed *The Soviet Encyclopaedia of Space Flight* (Moscow Mir Publishers 1969) pp 376-77 Mikhail Rebrov "Saga from the Archives of Document No 23891 and an Unknown Space Project" (English title) *Krasnaya zvezda* May 13 1995 p 6 Earlier simulations of ten to 120 days duration were carried out by 1964 See "For Future Space Flights A Unique Experiment of Soviet Scientists" (English title) *Prauda* September 11 1964 P 4

⁵ Semenov ed *Raketno Kosmicheskaya Korporatsiya* p 280 Igor Afanasyev "Piloted Flight to Mars A Quarter Century Ago" (English title) *Vestnik uozdushny flota* no 7-8 (1996) 103-05

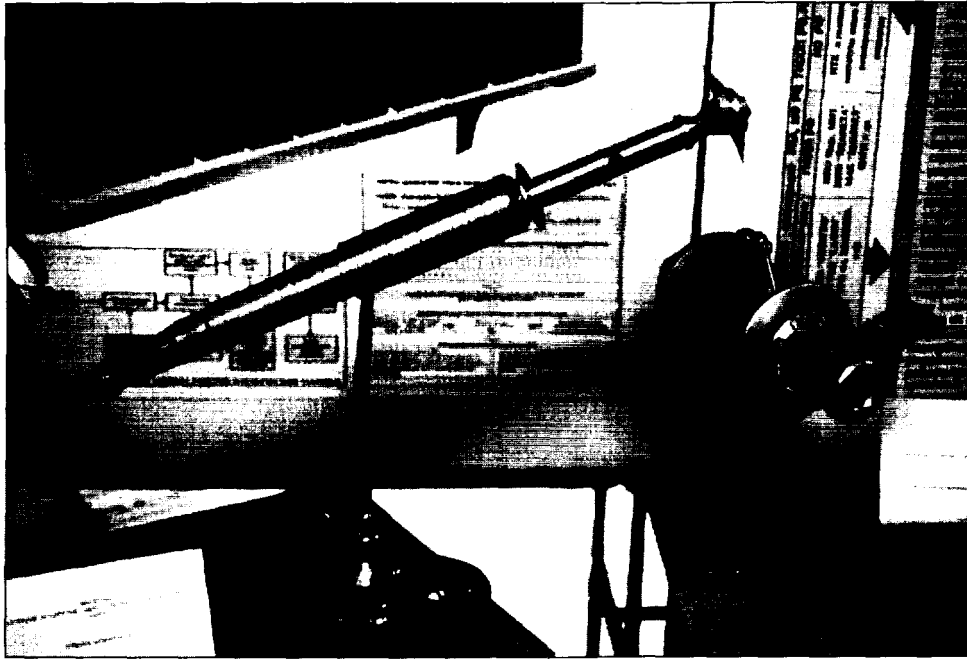

This is a model of the pencil shaped MEK piloted Martian spacecraft offered in 1969 by Mishin's design bureau as part of the Aelita effort. At the base of the stand is another model evidently showing the Martian lander with its atmospheric braking aeroshell (shown in more detail in the bottom photo) On the right is a robotic Martian spacecraft (copyright Mark Wade)

In Earth orbit, the MEK looked like a long needle. The 150-ton complex would be assembled in Earth orbit after two launches of a modified NI booster. The first rocket would carry two components: the Martian Orbital Complex (MOK) and the Martian Landing Complex (MPK). The second NI would carry a fully functioning low-thrust electric rocket engine powered by two nuclear reactors. Each reactor was installed on one extreme end of the complex and protected from other systems by a "shaded shield"; the cone-shaped propellant tanks for the electric rocket engines would provide additional protection to the crew from radiation from the reactors. The actual propulsion nozzles would be placed between the shade and the tanks. The complex would also have an extensible telescopic thermionic radiator for the energy sources, which would have a node to allow for docking and undocking to the MOK and MPK.

The MOK formed the main areas of living for the crew. From one end to the other, the complex had seven sequential sections: the instrument-aggregate compartment, the working compartment, the laboratory compartment, the biotechnology compartment, the living compartment, the "salon" compartment, and the orientation engine compartment. The MPK had an unfurlable aeroshell for aerodynamic braking into the Martian atmosphere. It was located behind the "shaded shield" of the main spacecraft. After separating from the main spacecraft complex in Martian orbit, it would discard its docking apparatus used for operations in Earth orbit and then use a liquid-propellant rocket engine to soft-land on the surface of the planet. The aeroshell encased a cylindrical "living compartment" linked to the main crew quarters via a hatch, as well as a two-stage ascent stage with a spherical cabin.

The MEK also contained the main crew return apparatus for returning the crew to Earth. The capsule was essentially a larger version of the "headlight-shaped" Soyuz descent apparatus with a lift-to-drag ratio of about 0.45, sufficient to significantly reduce g-levels upon terrestrial reentry. The capsule had a base diameter of 4.35 meters and a height of 3.15 meters.

The MOK and MPK would dock in Earth orbit with the electric rocket engine plus nuclear reactor payload. Docking would be followed by the ignition of the electric engines to begin its slow acceleration into ever larger spirals around Earth. After the complex cleared Earth's radiation belts, a Proton rocket would launch a 7K-L1 Zond-type spacecraft into Earth orbit with a crew. The Blok D fourth stage would accelerate the Zond to meet with the MEK in high orbit. Having entered the MEK, the crew would verify the operation of all systems on the complex with the option of abandoning the vehicle if there were serious problems. After reaching transplanetary velocity, the MEK would "shoot" out of Earth orbit in a trajectory toward the Red Planet. The electric engines would shut down at this point and stay in "cold storage."⁶

Calculations at the time had allowed engineers to compute the cumulative dose of radiation during periods of high solar activity that doctors believed would be acceptable for interplanetary crews. Based on these data, the crew of the MEK would stay in the special radiation shelter, which was in the form of a passage in the main instrument-equipment bay of the ship. The workload of the cosmonauts during both the outbound and inbound trips would be reduced as much as possible by making operations almost fully automated. Computers would deliver information on the spacecraft systems' operation based on an algorithm producing three values: "normal," "not normal," and "failure." The crew would be able to carry out any in-flight repair of the ship's radio and electronic equipment, designed to be easily accessible in the form of replaceable units. The effects of long-term gravity on the crew was still a potential unknown in 1969, and one option engineers seriously considered was the use of artificial gravity by rotating individual portions of the giant spacecraft around its axis. Research later proved that such rotations would be harmful to the body because of the appearance of "Coriolis" acceleration that distorted the human perception of gravity.⁷

The coast to Mars would take 150 days, after which the electric engines would start operating again to perform Mars orbit insertion. The MEK would take sixty-one days to brake into high orbit and a further twenty-four days to shift to low orbit. The crew would spend an additional week surveying possible landing sites for the MPK. Three of the six cosmonauts on board would then enter the lander and touch down on the surface. After about a weeklong mission on the surface, the ascent stage of the MPK would lift off and automatically rendezvous with the MOK. The crew would transfer from the former to the latter's living compartment, and the no-longer-needed lander would be discarded. A week later, the

⁶ Afanasyev "Piloted Flight to Mars "

⁷ I B Afanasyev "Unknown Spacecraft (From the History of the Soviet Space Program)' (English title) *Nouoye v zhizni Nauke tekhnike Seriya kosmonautika astronomiya* no 12 (December 1991) 1-64

crewmembers would begin their return trip in the MOK—seventeen days to escape Mars and another sixty-six days to gather velocity to reach Earth. During passive flight, the spaceship would pass as close to the Sun as possible, flying between the orbits of Venus and Mercury to accrue more velocity. Another seventeen days of active engine firing would lead to a second passive phase. Three days before reaching Earth, the electric rocket engines would be switched on again. The crewmembers would separate from the main MEK spacecraft in their return apparatus and land by parachute back on Earth with the results of their scientific experiments and Martian soil samples."

Serious work on closed-cycle life support systems in support of the Mars program was carried out at the premises of the Moscow-based Institute for Biomedical Problems. In 1970, as part of the MEK project, scientists at the institute created a Scientific-Experimental Complex (NEK) for "special biomedical testing of prospective space life-support systems." The NEK consisted of three modules: one with a volume of 150 cubic meters, the second with a volume of 100 cubic meters, and the third, the aggregate compartment, with a volume of fifty cubic meters. Each module was connected with an airlock and had radio-television systems, anti-fire alarm systems, and extinguishers. Two of the modules had special areas for rest and athletic training. There was also a special kitchen for preparing food from sublimated products, as well as a doctor's area with a full complement of medication and instruments.⁸

One of the most intensive areas of focus in the design of the MEK was the nuclear energy source, not only to power the ship, but also to provide power to the electric rocket engines. In the 1960s, scientists and engineers at TskBEM had engaged in research on creating a new class of slow-melting and high-temperature materials and new heat carriers—that is, new technologies for facilitating the creation of small-scale thermionic reactors. Several different complex test stands were built for testing methods, materials, and equipment at very high temperatures. Between 1965 and 1968, TskBEM, together with the Physical-Power Institute at Obninsk, designed and manufactured a new thermionic reactor using fast neutrons. By 1970, they had created the new FS-1 critical test stand, essentially a reactor of zero power, to verify changes in the structure, geometry, composition, and configuration of the primary components of the nuclear-physical model of the thermionic reactor. Eight critical assemblies were made at the time, leading eventually to the creation of the IIB97 nuclear energy source.

Based on this research, for the MEK, TskBEM engineers worked on a draft plan between 1966 and 1970 for nuclear energy units and electric rocket engines for the spacecraft and its launch vehicle. The power units and the rocket engines were created in single block (YaE-1 and YaE-1M) and triple block (YaE-2 and YaE-3) configurations, with each block consisting of one thermionic reactor. The performance characteristics were:

Unit	Power Output
YaE-1	2,500–3,000 kilowatts
YaE-1M	5,000 kilowatts
YaE-2	Three by 3,200 kilowatts
YaE-3	Three by 5,000 kilowatts

The spacecraft would have two low-thrust electric rocket engines of 6.2 and 9.5 kilograms thrust, respectively. Their specific impulses were remarkable, attesting to their high-performance

8 Afanasyev. "Piloted Flight to Mars "

9. Aleksandr Andryushkov. "The Secret Cosmodrome" (English title). *Krasnaya zvezda*. December 3, 1994. p 6

capabilities: 5.000 and 8.000 seconds. respectively. All of the materials on these energy units and associated engines were examined and approved by an expert commission of the Academy of Sciences under the leadership of Academicians Aleksandr P. Aleksandrov and Boris N. Petrov. The commission recommended further work to create the YaE-2 and YaE-3 units on an experimental basis." Through early 1969. TsKBEM engineers were seriously considering using a *recoverable* nuclear reactor aboard the Mars spacecraft.

Work on the MEK was, of course, not isolated from the development of a suitable launch vehicle for sending the spacecraft to Mars. Conceptions of an updated NI to use for the mission remained in constant flux throughout 1969 as different models were proposed at different points. Early in the year, the most favored version was the NIF-V3, a technical proposal distinguished from the original NI by the use of improved first and second stages and a completely new third stage using high-energy liquid hydrogen-liquid oxygen (LOX) as propellant. By March 1969, the most likely plan was to use two NI-derived boosters for launching components of the MEK into Earth orbit. One of the NIs would use the new liquid hydrogen-LOX Blok S on fourth stage. Based on this research, throughout April, there was intensive work on a radically improved variant, called the NIM. On May 28, 1969, Mishin signed the pre-draft plan for the NIM booster, designed specifically to carry out a Mars landing project. Among five projected variants of the NIM, three used liquid hydrogen-LOX engines on the second and third stages. The first stage would use thirty powerful 250-ton-thrust engines."

Mishin's NIM-MEK Mars landing plan was not the only component of the new Mars offensive in 1969. When Soviet space leaders such as Smirnov and Afanasyev provisionally approved a Mars program to take the steam out of Apollo, there was a clear consensus that this would have to be a massive integrated project involving the major Soviet space design organizations. The official decree in support of the Aelita program was issued by the Ministry of General Machine Building in resolution no. 232 on June 30, 1969, two weeks before the flight of Apollo 11 to the Moon." According to the order, the assigned chief designers were to deliver "materials" for the Aelita program by the third quarter of 1970. Participating in the effort was not only Mishin's TsKBEM, but also General Designer Chelomey's TsKBM and Chief Designer Yangel's KB Yuzhnoye. By August 1969, there were, in fact, three complete pre-draft plans for a Soviet Mars landing project, one each from the three design bureaus. The volume and scale of the work, however, seem to have discouraged even the most enthusiastic of participants. By the end of 1969, both Mishin and Yangel pulled out of Aelita, leaving it wholesale to Chelomey. Mishin clearly had a good reason: by the end of 1969, he was knee-deep in a new space station program. At the same time, his organization was involved in the flight testing of the troubled NI and formulating variants of the NI for improved piloted lunar landing missions for the early 1970s. It would simply be impossible to manage a Mars program concurrently.

10 Semenov ed *Raketno Kosmicheskaya Korporatsiya* pp 411-12 A Koroteyev Yu Demyanko and Ye Kuzmin 'From the History of Space Science. The Scientific Research Institute of Reactive Propulsion' (English title) *Aviatsiya i kosmonavtika* no 6 (November-December 1993) 39-41

11 For mentions of the NIM in Russian documentation see Semenov ed *Raketno Kosmicheskaya Korporatsiya* pp 280 412

12 V M Petrakov "Soviet Rockets for Space Apparatus" *Journal of the British Interplanetary Society* 49 (July 1996) 277-80 V M Petrakov 'From the History of the Development and Creation of Carrier Rockets in the USSR' (English title) in *Trudy XXup chteny posuyashchennykh razrabotke nauchnogo nasladieniya i razvitiyu rdey K E Tsiolkovskogo* (Moscow RAN 1994) p 173 Sergey Khrushchev *Nikita Khrushchev krizisy i rakety uzglyad iznutri* tom 2 (Moscow Novosti 1994) p 526 One somewhat unreliable source states that the order came on June 30 1968 See Mikhail Rudenko "Designer Chelomey's Rocket Planes' (English title) *Vozdushny transport* 52 (1995) 8-9

Nothing is known about the Yangel offer, but given his previous record with piloted space projects, it is not surprising that he, too, did not participate in Aelita after 1969.¹³

Characteristically, Chelomey's offer for Aelita was far more ambitious than Mishin's NIM-MEK idea, bordering almost on fantasy. His own stab at a lunar landing project, the UR-700/LK-700 project, had died a slow death in early 1969, but it had provided a sound basis to consider more advanced concepts for the Mars effort. For Aelita, Chelomey used the UR-700 as a springboard and offered the even more gigantic UR-700M rocket—a launch vehicle so massive that it was quite possibly the most powerful booster ever seriously conceptualized anywhere in the world. The only comparable studies were NASA's Nova heavy-lift booster proposals dating from the early 1960s.¹⁴

By April 1969, General Designer Chelomey was looking at several different preliminary variants of the UR-700M, each with differing capabilities and configurations. The mass and performance characteristics were unprecedented:

Variant	Launch Mass	Payload to Earth Orbit	Propellants
1	4,820 tons	130–150 tons	Conventional
2	7,890 tons	230 tons	Conventional
3	7,890 tons	300 tons	Liquid hydrogen-LOX
4	Unavailable	350 tons	Nuclear
5	Unavailable	1.700 tons	Nuclear

Variants 1 and 2 differed by the composition of the number of strap-ons or engines. Among the missions being considered for these two versions were lunar landing expeditions lasting thirty days, automated flight to Mars and Venus with the landing of eleven-ton modules on the surface, and piloted landing expeditions to Mars with three cosmonauts on Mars for thirty days. In addition, on variant 2, two payload blocks of 230 tons would allow for the testing of a special nuclear rocket engine on an upper stage. Variant 3 would use high-performance cryogenic propellants, allowing for a landing on the Moon of six cosmonauts for missions lasting from one month to one year, piloted flight to Mars and Venus using atmospheric braking, and, with the use of two 230-ton payload blocks linked in Earth orbit, a landing expedition to Mars of four cosmonauts. Certainly, the most ambitious early conceptions were variants 4 and 5 using nuclear rocket engines on the third stage of the UR-700M. Engineers considered two different design schemes for the engine, one using a gas-phase reactor and the other a solid-phase reactor."

These initial exploratory studies of the UR-700M led to two different layouts for the rocket. The first variant of the UR-700M was similar to the UR-700 in basic design—that is, it consisted of a core of three modules (the second stage) surrounded by three strap-on clusters (the first stage), each consisting of two modules. The change was in the engines: Chelomey substituted each RD-270 with four RD-253s. Thus, despite Chelomey's intensive criticisms of

13. In Petrakov, "Soviet Rockets for Space Apparatus." the author states that "Mishin, already heavily involved in manned spacecraft work for the space station programme, declined the work [on the Mars expedition], leaving the TsKBM in sole charge of Aelita."

14. For an overview of the Nova studies, see Keith J. Scala and Glen E. Swanson, "They Might Be Giants," quest 1(3) (Fall 1992): 12–27; Keith J. Scala and Glen E. Swanson, "They Might Be . . . Giants," quest 2(1) (Spring 1993): 17–26; Keith J. Scala and Glen E. Swanson, "They Might Be . . . Grants," quest 2(2) (Summer 1993): 4–20

15. For another version of the UR-700M, see Christian Lardier, *L'Astronautique Soviétique* (Paris: Armand Colin, 1992), p. 252

the NI booster for having too many engines on its first stage. he was now choosing that same option. One wonders if his criticisms of the NI abated with the emergence of the UR-700M. Chelomey's new rocket, with a total of thirty-six engines firing at liftoff, would develop about 5,400 tons of sea-level thrust. The rocket was topped off by a third stage of four modified RD-253s for altitude use, as in the UR-700. Its fourth stage was a bold new step in rocket design technology: Chelomey proposed the use of a nuclear rocket engine, the RD-410, a relatively unknown engine developed by Glushko's Energomash design bureau. Total Earth-to-orbit payload capability for this version of the UR-700M was 240 tons.¹⁶

Very little is known about the RD-410 engine, except that it had a thrust of seven tons. It is not clear whether the RD-410 engine was the same unit as the similarly designated RD-0410, also a nuclear rocket engine developed at the very same time as a cooperative effort between the Design Bureau of Chemical Automation (formerly OKB-154) and the Scientific-Research Institute of Thermal Processes. The RD-0410, with a thrust of just over three and a half tons, was a highly advanced engine, exceeding in its performance characteristics even concurrent American nuclear engine models. A stand for testing the engine was built beginning 1962 by KB Luch at a secret site about fifty kilometers southwest of Semipalatinsk-21. Testing began in 1971.¹⁷

The second variant of the UR-700M was truly a monster. Instead of the standard modules just over four meters in diameter so favored by Chelomey, engineers came up with a central core twelve and a half meters in diameter surrounded by four nine-meter-diameter blocks. The core (the second stage) would use twelve 600-ton-thrust engines, while the strap-ons (the first stage) would each use eight of the same engines. These engines, working on LOX and kerosene, would be developed by Glushko, who evidently had finally decided to abandon his boycott of LOX engines. A third stage, with a diameter of twelve and a half meters, would use six NK-35 engines, each with a thrust of 220 tons. These were new high-performance liquid hydrogen engines developed by Kuznetsov's KB Trud. Compared to the Saturn V's modest 130 tons, this behemoth would be capable of lifting 750 tons to Earth orbit. With a launch mass of 16,000 tons and a length of about 145 meters, this variant of the UR-700M was evidently the most preferred version for Aelita because it satisfied one of the main criteria of the plan—to use only a single docking (that is, assembly of a 1,500-ton complex) in Earth orbit to accomplish the Mars landing. Other requirements included simultaneous development of all the rocket engines, a "packet" layout for the booster, the use of multiple engines on each block, the possibility of manufacture of the giant in a major city, and extensive ground testing.¹⁸

Very little is known about the MK-700 Martian landing spacecraft conceptualized for the Aelita program. No doubt, the actual ship traced its lineage to the abandoned LK-700 lunar lander. The spacecraft looked roughly like a series of four truncated cones one on top of the other. The ship had a pair of large solar panels to provide power during the trip. As a whole, the development of the UR-700M rocket was assigned to TsKBM's Branch No. 1 at Fili, although Chelomey's main center at Reutov took the responsibility of developing the MK-700 piloted spaceship. Chelomey was enthusiastic about the entire effort, perhaps seeing in it a possibility to vindicate his various defeats in the space program at the hands of his enemies. Minister Afanasyev, a staunch supporter of Chelomey's, seems to have been the primary

16 V. Karask, O. Sokolov and V. Shishov, 'Known and Unknown Pages of the Russian Khrunichev Centers Space Activity' presented at the 47th Congress of the International Astronautical Federation, Beijing, China, October 7-11, 1996.

17 Leonid Kvasnikov, Anatoliy Kostylev and Vladimir Maksimovskiy, "Nuclear Rocket Engines" (English title) *Vestnik vozdushnoi floty* no. 6 (November-December 1996) 53-55.

18 Petrakov, "Soviet Rockets for Space Apparatus" Petrakov, "From the History of the Development and Creation of Carrier Rockets."



This is a close-up view of Chelomey's MK 700 Martian lander spacecraft that was proposed as part of the *Aelita* program to send Soviet cosmonauts to Mars in the late 1970s. In the background is a model of a variant of the Salyut space station (copyright Mark Wade)

instigator in the government in favor of Chelomey's *Aelita* project. Remarkably, Chelomey delivered on his promise. In April 1970, he completed the predraft plan for the MK-700, and in October of the same year, he signed off on the predraft plan for the UR-700M rocket." Somewhat unrealistically, Chelomey promised that he could bring the project to fruition within *three* years.

At the time, *Aelita* not only included the UR-700M-MK-700 project but also encompassed a larger Mars-directed offensive, including automated missions in 1971, 1973, and 1975, leading to a piloted landing between 1978 and 1980. One of the more interesting missions of this armada was the 5NM mission planned for launch on the NI rocket. Also known as the Heavy Interplanetary Automatic Ship, the project was supervised by the Lavochkin Design Bureau under Chief Designer Babakin. Inspired by the success of the Luna 16 sample return, Babakin proposed using the 5NM spacecraft to recover a sample of Martian soil. The launch would occur in 1975, the ship would land on Mars in 1976, and then it would return to Earth in 1977.¹⁹

For all of the enthusiasm of Afanasyev and Chelomey for *Aelita*, the goals of the program could not be justified given the enormous amounts of expenditures involved. As a respected Russian space historian noted in 1991:

... even as the proposals for [the UR-700M-MK-700] program were being developed, it became clear that the impact of the first flight of a man to Mars on public opinion would be disproportionately small in comparison with the material expenses that would attend the flight."

Aelita really had no chance. By September 1970, the Military-Industrial Commission considered eliminating *Aelita* from its next five-year plan, 1971-75, but apparently after further discussions opted to include it. The participants were to produce a draft plan for the project in

19. Khrushchev. *Nikita Khrushchev* tom 2, p. 526; Petrakov. "Soviet Rockets for Space Apparatus."
20. K. Lantratov. "To Mars!" (English title), *Nouosti kosmonautiki* 21 (October 7-20, 1996) 41-51
21. Afanasyev. "Unknown Spacecraft." p. 40

1972. The forces against the massive undertaking, however, proved to be too strong. Soon after Chelomey finished the predraft plans for his booster and spacecraft, his ambitious idea died a slow death. By the end of 1972, the Soviet piloted space program remained engrossed in both its space station and the lunar landing projects; cosmonauts on Mars would have to remain a dream of the future. Like most of Chelomey's other projects, disinterest from the Soviet leadership did not deter him from quietly pursuing his own ideas, and it is quite likely that some low level of work continued on the UR-700M and its MK-700 ship for several years into the early 1970s. Some components of Aelita escaped outright cancellation. In particular, Babakin's 5NM project remained a strong contender for approval. In general, however, the aborted Soviet Mars offensive of 1969-70 was a child of political circumstance. Born out of the shock of Apollo 8, it did not have sustainability to survive into less politically charged times of the space race.

A Month on the Moon

In July 1969, when the N1 rocket exploded on its pad at Tyura-Tam, no one could have guessed that it would take two years before another N1 launch took place. The investigation into the accident did not finish until July 1970; in fact, it was as late as May 1971 before one of the subcommissions submitted its findings, concluding that the explosion had occurred because of a problem in an oxygen sensor. By December 1970, Mishin was looking ahead to the next launch of booster no. 6L in January 1971, with booster no. 7L following in June. Throughout December 1970 and January 1971, the Council of Chief Designers in charge of the N1-L3 program met several times to discuss the prelaunch preparations.²² There were still doubts on many technical issues that were not clarified to the satisfaction of several members, including such perennial problems as data on the pulsation pressure of the tanks and pipelines. On February 10, 1971, the technical leadership of TsKBEM met specifically to discuss the N1-L3 program, assessing the pace of preparations for future launches in the effort. The next N1 launch would carry a mass model of the L3 stack instead of the actual orbiter and lander—a decision most likely taken so as not to lose flight models of the Lunar Orbital Ship (LOK) and the Lunar Ship (LK) in case the N1 rocket failed to deposit its payload in orbit.

The assessment of preparations for the two subsequent launch stacks, boosters 7K and 8L, was mixed. While both N1 rockets were on schedule, there was still much uncertainty regarding their payload blocks, primarily because of delays in the delivery of components from subcontractors, in particular, the Arsenal Machine Building Plant, responsible for manufacturing the attitude control blocks for the orbiter and the lander. Booster 7L would carry an automated LOK and a mass model of the LK, while 8L would carry automated models of the LOK and LK. These two vehicles would carry out a fully automated lunar landing on the surface of the Moon. Booster 10L would carry the first piloted LOK in addition to an automated LK for a repeat of a robotic landing. The first piloted landing on the surface of the Moon was set for March 1973 on booster 11L.²³ Tests throughout 1971 continued for certifying the LOK for piloted flight.

22 The Council of Chief Designers for the N1 L3 program in December 1970 were V. P. Mishin (TsKBEM and council chief), A. P. Abramov (TsKBEM), V. P. Barmin (KB OM), A. C. Iosifyan (VNII EM), A. M. Isayev (KB KhimMash), I. I. Ivanov (KB Yuzhnoye), N. D. Kuznetsov (KB Trud), N. A. Lobanov (NII AU), A. M. Lyulka (KB Saturn), A. S. Mnatsakanyan (NII TP), N. A. Pilyugin (NII AP), M. S. Ryazanskiy (NII Priborostroyeniya), C. I. Severin (KB Zvezda), V. C. Stepanov (Turayev Branch of MMZ Soyuz), C. I. Voronin (KB Nauka), and M. K. Yangel (KB Yuzhnoye). Additionally invited to participate in the proceedings were P. A. Agadzhanov (TsKIK), A. Yu. Ishlinskiy (Institute of Mechanics AN SSSR), A. C. Karas (CUKOS), M. V. Keldysh (AN SSSR), V. Ya. Likhushin (NII TP), C. P. Melnikov (NII 4 Space Branch), Yu. A. Mozzhorin (TsNII Mash), B. N. Petrov (Interkosmos), G. I. Petrov (IKI AN SSSR), and V. P. Pukhov (NII KhimMash).

23 N. Kamanin, "I Feel Sorry for Our Guys" (English title), *Vozdushniy transport* 15 (1993): 12.

These included water-landing tests and the verification of the giant launch escape tower for the L3 stack. The LOK would be the first Soviet piloted spacecraft whose primary landing target was the Indian Ocean. TsKBEM engineers also overcame major technical obstacles in building the first fuel cells for a Soviet piloted spacecraft, six years behind the United States. By 1971 and 1972, the engineers were ground-testing a four-and-a-half-kilowatt power supply unit called Volna for the LOK, which ran on alkaline and hydrogen-oxygen fuel cells with an efficiency rating of about 60 percent. Volna would provide electricity, oxygen, water for drinking, and support services during the lunar mission.²⁴

Preparations for the next NI launch were bogged down in technical delays, compounded by a lack of confidence in a success. It was only in late May 1971 that the rocket was finally moved to the second NI launch pad at site 110L, the one that had remained intact after the catastrophic explosion during the summer of 1969.²⁵ Evidently, Chief Designer Barmin's engineers had not yet begun reconstructing the destroyed pad at site 110P. By December 1970, the consensus was to carry out the remaining NI test launches from 110L while, at the same time, begin the construction of two completely new pads elsewhere at the launch range.

Booster 6L's payload consisted of mass mock-ups of the LOK and LK. There was no functional emergency rescue system on top of the L3 stack. The primary objective of the mission was to test, as simply as possible, the operation of the first three stages of the NI. No lunar operations were planned, and, in fact, the NI was to be launched outside a convenient lunar launch window.²⁶ There was some minor drama during the searing hot days preceding the launch attempt. In an unexpected act of nature for arid Tyura-Tam, there was a violent rainstorm at the launch site while the NI rocket was installed at the pad. For Kazakhstan, this was quite an anomaly, and engineers were very worried about the effect of rain on the NI rocket's electronic circuitry. Some State Commission members proposed bringing the booster back to the assembly-testing building and then "drying" it, but Mishin was against this, apparently fearful that such a move would serve no purpose other than delaying the launch by days if not weeks. In the end, Mishin got his way.²⁷ The State Commission originally set the launch for June 20, but postponed it initially by two days to June 22. But there were more delays. Air Force representative Col. General Kamanin wrote in his diary on June 24 that:

The launching of the NI has again been put off. Now *Mishin* hopes to put it into space on *June 27*, but there are so many failures and malfunctions that this date may also prove unrealistic. General[Aleksandr G.] Karas [the commander of the Chief Directorate of Space Assets] called from the launch site today. He is dejected. The telemetry equipment on the *NI* has given out, and there are other important malfunctions which may again delay the launching. This bad rocket is a great liability to our space program."

The "bad rocket" was finally launched at 0215 hours, 8 seconds Moscow Time on June 27, 1971. As soon as the booster lifted off, telemetry on the ground indicated that the roll control system was behaving abnormally. There were unexpected gas-dynamic moments (eddies and countercurrents) at the base of the booster, which caused the NI to roll around its axis. As the rate of roll increased steadily, by T+48 seconds, the large amount of torque began to destroy the second stage. Three seconds later, the KORD system shut down all the engines. As the

24. Sergei Khudyakov. "Power Units Run on Fuel Cells," *Aerospace journal* no. 6 (November-December 1996): 42-43.

25. "Soviet Lunar Booster Souvenir." *Spaceflight* 34 (August 1992): 274

26. Afanasyev, "Unknown Spacecraft "

27. Mikhail Rudenko, "Four Steps From the Moon" (English title), *Moskovskaya pravda*, July 19, 1994, p. 10.

28. Kamanin, "I Feel Sorry for *Our Guys*." p. 12.



This photo captures the spectacular night launch of the third N1 rocket in June 1971. Although the booster cleared the tower, unanticipated rotations around the main vertical axis of the vehicle led to yet another catastrophic failure. (copyright Quest)

rocket continued to break up in the air, it flew about twenty kilometers from the pad and hit the ground, creating a crater thirty meters wide and fifteen meters deep. Fragments of the rocket were scattered across an area of several kilometers." While it was the first time that all of the N1's engines had fired together, the third failure in a row, not surprisingly, affected morale. Boris A. Dorofeyev, at the time the "lead designer" of the N1 rocket, remembered that:

such major accidents had a depressing effect on the personnel. But no one entertained the thought that the N1 was doomed, or that its defects were of a chronic nature. People worked energetically, many asked to have their stay on the firing-range extended, and everyone felt that the rocket would "grow out of it," and that success was not far off.²⁹

This bottom-up enthusiasm for a project that had spanned nearly a decade without any tangible results may sound irrational from a Western perspective, but the Russians were clearly in it for the long run. Despite three consecutive failures, many space officials continued to believe that the future of the Soviet space program depended on the N1 rocket.

The N1 may have become ensconced as a national, albeit secret, Soviet asset, but the L3 lunar landing program was in much bigger trouble by mid-1971. Already almost three years late, much of the technology and design approaches for the creation of the L3 complex were becoming outdated. Many continued to believe, with good reason, that flying the L3 to the Moon with

29. Afanasyev. "Unknown Spacecraft": Igor Afanasyev. "N1: Absolutely Secret" (English title). *Krylya rodny* no. 11 (November 1993): 4-5.

30. Sergey Leskov. "How We Didn't Get to the Moon" (English title). *Izvestiya*. August 18, 1989, p. 3.

the limited capabilities of the LOK and the LK would be a risk not worth taking. The early-1969 talks on a post-Apollo response had led to considerations of an improved lunar landing project with better characteristics, something that would not only guarantee the safety of a crew, but also be a significant improvement over any Apollo mission. In April 1969, Mishin told Brezhnev that his design bureau would work on a lunar project capable of sustaining a crew of three cosmonauts for extended periods on the Moon and equipped to travel long distances on the lunar surface. By September of the same year, Mishin was examining the preliminary documents on such a plan, and by January 1970, the proposal had a name, the L3M, which was a modified L3.

Engineers approached the formulation of the L3M with the weaknesses of the original L3 plan in mind—that is, what kind of improvements could be made given existing hardware and technology? Clearly, one of the vulnerable links in the chain was the docking of the LK with the LOK once the lander had lifted off from the lunar surface. Given Soviet weaknesses in microelectronics technology, the engineers had faced great difficulty in designing a completely automated rendezvous and docking system, as evidenced by the docking failures on Soyuz 2/3 and Soyuz 718. Lunar dockings would be even more complex given the poor knowledge of navigation conditions around the Moon and the difficulty of assisting the cosmonauts from Earth. One possibility was to design a very heavy launch vehicle capable of a direct ascent profile to the lunar surface, bypassing the need for rendezvous. Studies, however, proved that such a profile would require a very heavy launch vehicle well outside the capabilities of the NI in the near future, even if augmented with high-energy stages. The other option was to launch huge components of the lunar ship separately and have them link up in lunar orbit. The extra mass afforded would allow the spacecraft to carry reliable rendezvous and docking instrumentation. It was the second option that the engineers decided to adopt for the L3M.³¹

The L3M lunar landing proposal depended on two major upgrades: an improvement of the NI and a redesign of the L3. Upgrades to the NI had, of course, been talked about for years. The most famous such modification was the NIM, proposed for use on TsKBEM's ambitious and abandoned Mars landing project. For the L3M plan, it seems that Mishin had returned to the old ideas of using high-performance liquid hydrogen-LOX upper stages for launching huge payload stacks into Earth orbit. Thus, the problem in many ways depended on the progress of developing these high-performance upper stages. Four such stages had been under development for several years, but only two—Blok S (to replace the current NI stage IV) and Blok R (to replace stage V)—had achieved any modicum of success. Certainly, one of the major problems was the lack of support from higher authorities to finance such efforts. While NASA was already flying several excellent high-performance upper stages, Soviet engineers were still writing unanswered letters on the importance of such propellant combinations. Throughout 1969, work on Blok R and Blok S was given high priority, with Mishin meeting several times with Chief Designers Lyulka and Isayev, who were responsible for the two engines, respectively.

The results of testing of these two stages changed the design of the upgraded NI for the long-duration lunar expeditions. In February 1970, the most favored option was to launch three NIs, two with Lyulka's Blok S and one with a modified variant of Blok D, named Blok DM, which used conventional propellants. To optimize the work being done and also to unify disparate efforts, Mishin's engineers at the time emerged with a conception for a new upper stage, designated Blok S_R, with a fueled mass of 77.9 tons. This block was examined in two different versions, the first with one of Lyulka's I1D57 engines and the second with either two or four of Isayev's I1D56M engines." In March 1970, the L3M proposal was narrowed down to an

31. Afanasyev. "Unknown Spacecraft."

32. Semenov, ed., *Raketno-Kosmicheskaya Korporatsiya*, p. 262. The I1D56M was a modernized variant of the older I1D56

option with two sequential missions, each using a much more improved version of the LK lander called the LKM:

- One launch of the NI with Blok S_R and the LKM for an automated lunar landing and return to Earth
- Two launches of the NI, one with a Blok S and one with a Blok S_R , which would link up in Earth orbit and take its piloted LKM on an extended visit to the surface of the Moon

While the L3M plan offered significant advantages over the original L3 profile, it was still by no means a certainty with respect to the Soviet space leadership. Throughout February and March 1970, there was much discussion on the preparation of an official governmental order from the Ministry of General Machine Building on the L3M proposal, but none seems to have been forthcoming at the time, evidently because of dissension among the chief designers on the details of the plan.

Mishin was clearly the primary sponsor of the L3M proposal, and it seems that he had trouble, at least initially, in gathering the necessary support to facilitate an official decree. Academy of Sciences President Keidyshev offered lukewarm support, advising that TsKBEM first needed to perfect the old NI-L3 before moving on to the L3M. He cautioned that funding for all these proposals were limited and thus Mishin should reduce his requests to cater to the exigencies of the day. With wavering support, by the end of 1970, there was still no official word on the proposal. Meanwhile, Mishin, on his own initiative, had continued to focus work at his design bureau on L3M, simultaneously with all the work on the NI-L3 and of course the new space station program. This time, he did not want to make the same mistake of going with an "all-up" testing philosophy, which had, to an extent, crippled the NI program. It was clear to him that one of the most important elements of the new L3M plan was the use of the high-energy upper stages. To fully test these out prior to their actual use on a lunar mission, Mishin's engineers, by April 1970, emerged with a proposal to develop a smaller version of the NI, called the NI I. Such an idea, with the exact same designation, had been offered by Korolev in the early 1960s, but had never gotten off the ground because of a lack of funding. As envisioned at the time, the NI I was a three-stage rocket with:

Stage	Origin
I	Blok B (stage II) from the NI
II	Blok V (stage III) from the NI
III	Blok S_M (modification of the high-energy Blok S_R)

In October 1970, Mishin met with Brezhnev to brief the Soviet leader on the course of the piloted lunar landing program. One of the main topics of conversation was the creation of an improved NI-L3 complex—effectively the NI-L3M proposal—and the use of high-energy upper stages for both the NI and the NI I. TsKBEM was evidently short of money to build test stands for the stages." As was typical of many other test programs, the NI I as a viable option did not last very long. Although it was discussed at the Military-Industrial Commission level in October 1970, by December, there were doubts about the feasibility of rapidly building the NI I in its current configuration. Eventually, it was completely abandoned. Mishin's engineers would have to make the direct jump from the NI to its modified version with high-energy stages.

³³ These stages included Blok S_I , Blok S_R , and Blok S_M . There were at least two conceptions of the NI I: one the basic NI I and the other called the NI IS.

The NII may have been dropped from consideration, but Mishin was allowed to proceed with his important Blok S_R stage. In May 1971, a formal decision was taken on the development of Blok S_R replacing the various previous incarnations of high-energy upper stages, such as Blok R and Blok S. Blok S_R would be a universal upper stage for launching heavy space apparatus into geostationary Earth orbit and for sending heavy automatic stations on trajectories to the planets. Its primary job, however, would be to serve as the lunar-orbit insertion stage for the L3M mission. After an initial planning stage involving comparisons of different liquid hydrogen-LOX engine configurations for a single variant, engineers adopted Chief Designer Isayev's I1D56M engine for the stage because it would "ensure the best characteristics."³⁴ In the final analysis, Blok S_R was equipped with two of Isayev's I1D56M engines with a primary thrust regime of 15.08 tons and a medium thrust regime of eight tons. It was capable of being fired up to five times over a period of eleven days in a state of weightlessness and vacuum—that is, deep space. The performance characteristics for this first Soviet liquid hydrogen-LOX engine were remarkably high, comparing very favorably to NASA's Centaur RL-10 engine in terms of specific impulse. According to preliminary calculations, Blok S_R could deliver a mass of 23.8 tons (for a piloted ship) or 24.1 tons (for an automated ship) into lunar orbit, twenty tons to geostationary orbit around Earth, or 27.8 tons to a trans-Martian trajectory. The stage itself was sixteen and a half meters in length and just over five meters in diameter.³⁵

The decision to select Isayev's I1D56M engine over Lyulka's I1D57 engine for Blok S_R had as much to do with technical considerations as it did with bureaucratic infighting. Lyulka's engine had run into serious technical trouble in 1970. By July, it was clear that its testing program was severely lagging, and by the end of the year, planners had all but given up on its use in the immediate future. The technical issues were compounded by interministerial jealousies. Lyulka's organization, the design bureau of the Saturn Plant, was part of the Ministry of Aviation Industry, and thus outside the "mainstream" of the Soviet space industry, which was part of the Ministry of General Machine Building. The latter's head, Minister Afanasyev, was evidently unwilling to have another chief designer from the aviation industry "interfere" in the NI-L3 program.³⁶ While Lyulka doggedly continued his work on Blok R, his engine was temporarily sidelined from the NI program.

A specific technical design for Blok S_R enabled more precise definition of the NI-L3M proposal in 1971 because the capabilities and mission profile depended to a great extent on the performance characteristics of the upper stage. The main component of the plan was the NIF, an upgraded NI that would incorporate improvements in each of its stages. The first three stages would use the new and better Kuznetsov engines capable of multiple firings, which were under development since 1970. Each replacement engine had the same thrust level as its predecessor. The fourth and fifth stages, strictly a part of the payload, would be replaced by a single high-energy upper stage, Blok S_R. The final configuration for the upgraded NI was:

34. Semenov, ed., *Rakelno-Kosmicheskaya Korporatsiya*, p. 262.

35. *Ibid.*

36. German Nazarov, "You Cannot Paper Space With Rubles: How to Save Billions" (English title). *Molodaya gvardiya* no. 4 (April 1990), 192–207; Lardier, *L'Astronautique Soviétique*, pp. 174–75.

Stage	Stage Name	Engines	Thrust Levels
I	Blok A	30 X NK-33	30 X 154 tons (sea level)
II	Blok B	8 X NK-43	8 X 179 tons (vacuum)
III	Blok V	4 X NK-39	4 X 41 tons (vacuum)
IV (payload stage)	Blok S _R	2 X 11D56M	2 X 7.54 tons (vacuum)"

The L3M flight plan would use two of these NIFs to carry out the mission. The payload block for the first NI would consist of Blok S_R and a Blok DM stage with a total mass of 104 tons. The payload block for the second NI would consist of another Blok S_R and the actual lunar lander, the LKM, with a total mass of 103 tons.

Little has been revealed on the technical details of the LKM. In appearance, it looked like a greatly enlarged version of the smaller LK from the L3 project. The mass of the LKM—23.7 tons, which was about four times more than its predecessor—would seem to indicate a dramatic leap in abilities. The LKM had two distinct stages, the descent stage (or landing adapter) and ascent stage (the living compartment). The descent stage consisted of four long legs attached to a central framework, which included various systems. The nineteen-and-a-half-ton ascent stage was shaped like a huge cocoon consisting of two major portions, both with its external spherical hull: the descent apparatus and the instrument compartment.

The almost eight-and-a-half-ton descent apparatus was shaped somewhat like an enlarged Soyuz reentry capsule and installed on the upper portion within the cocoon. It was internally connected to the cylindrical instrument compartment in the lower portion of the cocoon. After launch and during flight, the cosmonauts would leave the descent apparatus and crawl into the instrument compartment to carry out all in-flight operations, including landing on the Moon. The instrument compartment afforded a large internal space with viewports to select an optimal landing site.³⁸ The main engine complex of the LKM was attached to the ascent stage and would be used several times throughout the mission. It included a primary and backup throttle-capable engine unit, both using storable hypergolic propellants: these may have been contracted to KB Yuzhnoye, which developed the LK main engine. The increased mass of the LKM over the earlier LK afforded significant upgrades in systems. One historian noted:

The use of the "direct configuration" made it possible to equip the craft with a complicated system of more advanced radio gear for the precise and reliable performance of maneuvers connected with searching, meeting, and docking in lunar orbit. Such a larger LK would moreover have had greater freedom of maneuver close to the surface to select a landing site.³⁹

37. Afanasyev. "Unknown Spacecraft". I Afanasyev. "The 'Lunar Theme' After NI-L3" (English title). *Aviatsiya i kosmonavtika* no. 2 (February 1993): 42-44, Jeffrey M. Lenorovitz. "Trud Offering Liquid-Fueled Engines From NI Moon Rocket Program." *Aviation Week & Space Technology*, March 30, 1992. pp. 21-22. An early version of Blok S_R was equipped with four 11D56M engines instead of two. See Semenov, ed., *Raketno-Kosmicheskaya Korporatsiya*, p. 262. The total mass of the NIF was 3,025 tons, and launch thrust (probably in vacuum) was 5,070 tons. The booster was capable of inserting 105 tons into Earth orbit, thirty-four tons to the Moon, and twenty-two tons into lunar orbit.

38. Afanasyev. "The 'Lunar Theme' After NI-L3." There was evidently another LKM configuration considered. This design resembled a Soyuz with its modules switched—that is, the descent apparatus on top of the living compartment. The crew would move from the former to the latter by means of "a crawlway-chute"—that is, not through a hatch in the heat shield. See Afanasyev, "Unknown Spacecraft."

39. Afanasyev. "The 'Lunar Theme' After NI-L3." p. 43.

Each NIF would launch its payload block toward the Moon using its own Blok S_R to accelerate to translunar injection. Near the Moon, the same stages would fire to put their respective payloads into lunar orbit. Once there, the two Blok S_R stages would be discarded, and the Blok DM stage would dock with the large LKM. If for some reason the docking failed, the cosmonauts could simply return to Earth in their LKM spacecraft without having to carry out any extraneous spacewalks. In case of a successful docking, Blok DM would decelerate the complex from lunar orbit and initiate a powered descent to the lunar surface. Much like the earlier L3 plan, after Blok DM's propellants were exhausted, the LKM would take over the remaining portion of the descent to the surface using its own engine. Depending on the size of the crew, the stay on the Moon would last from five (three cosmonauts) to fourteen days (two cosmonauts). After the entire surface exploration was over, the cosmonauts would lift off from the Moon in the living compartment, leaving behind the large descent stage on the surface. Once again, using its own engine, it would directly fire itself on a trans-Earth trajectory. Another less preferable option was to enter an intermediate orbit around the Moon before returning to Earth. Once near Earth, the living compartment would open up into two pieces, much like a clam, and release the actual descent apparatus containing the crew. After a controlled reentry into Earth's atmosphere, the cosmonauts would land either on Soviet territory or in the Indian Ocean. @

The NIF-L3M plan offered the hope of carrying out a series of impressive lunar landing missions. However, while the Communist Party, government, and industry had been lukewarm at best on the N1-L3, would they commit to the expanded version of it? The central question was obviously financing, and money was, in fact, one of the crucial issues in L3M planning within TsKBEM. There was also the question of what to do with the old L3 project. To resolve these issues, the Politburo signed an order on February 17, 1971, titled "On the Designation of an Expert Commission on N1-L3 Under the Chairmanship of M. V. Keldysh." The new Expert Commission would be tasked with three goals:

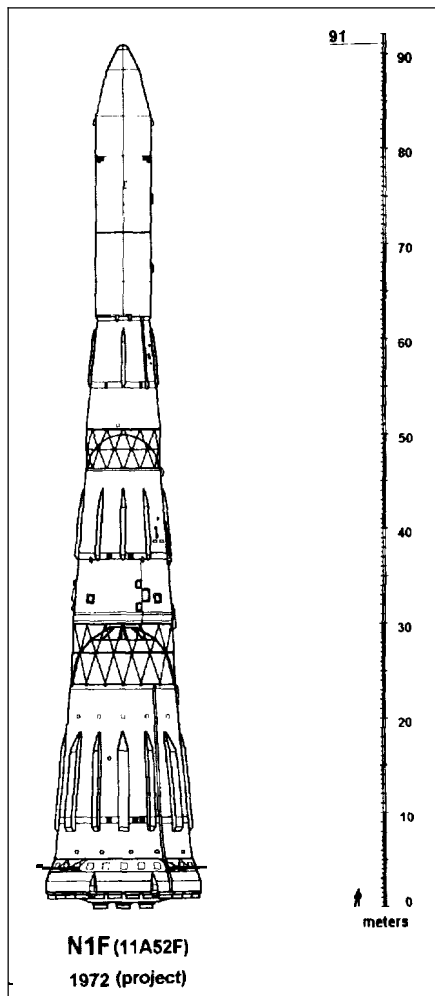

The NIF variant of the basic N1 rocket was intended to launch the advanced L3M complex for long-duration stays on the Moon. The program received preliminary approval by the Council of Chief Designers in May 1972 (copyright Peter Gorin)

40 *Ibid.*, V P Mishin, "Why Didn't We Fly to the Moon," (English title) *Znaniye tekhnike seriya kosmonautika astronomiya* no 12 (December 1990) 3-43 Afanasyev "Unknown Spacecraft"

- To evaluate the possibility of carrying out a lunar landing with one cosmonaut (that is, the L3)
- To evaluate the optimal program of work with regards to the Moon
- To evaluate prospective programs (that is, the L3M)

Col. General Kamanin, who was not a member of this Expert Commission, had some interesting comments on the body in his journal entry dated March 4, 1971:

For several years I have argued [I made two special visits to the Central Committee of the Party and repeated visits to the Military-Industrial Commission) that the N1 rocket and the lunar L3 spacecraft were hopelessly outdated and that our Moon mission program should be drastically revised. Finally, the Central Committee and the Council of Ministers have appointed a commission, chaired by Keldysh, which has been given until May 1, 1971, to answer the question of what to do with the lunar complex and with the existing mission-to-the-Moon program. My answer would be most definitely that the N1 rocket and the L3 spacecraft should be scrapped, that Chelomey's UR-700 rocket should be modified and a new lunar probe designed with a view to sending the first mission to the Moon in 1974-75. Mishin and his supporters are afraid of such a prospect: they have staffed the panel with people who will toe their line. The most likely outcome will be that the Keldysh panel will recommend continued attempts to "cure" a bad rocket and an equally bad spacecraft.⁴¹

Kamanin was not entirely correct that the commission was staffed with people sympathetic with Mishin. Keldysh presided over six different subcommissions whose heads were chief designers and academicians from various branches of the aviation and missile industry, many of whose organizations had not participated in the N1-L3 program, nor had any vested interest in the project. Only five senior officials from TskBEM were members of these subcommissions.⁴²

At a meeting of the commission on May 31, Keldysh asked TskBEM to prepare a formal proposal on the future of the N1-L3 program by June 15. Immediately, Mishin assembled his senior deputies, and through the ensuing days, there was much discussion on the issue. The preliminary plan was to follow through on piloted lunar exploration in three stages:

- Use the N1-L3 for piloted lunar-orbital flights with automatic landings of the LK
- Use the N1-L3 for a lunar landing, using both Earth-orbit rendezvous (to deliver the crew) and lunar-orbit rendezvous
- Use the N1-L3M to link up elements in lunar orbit for an extended lunar landing and then directly return to Earth⁴³

The pressure to completely abandon any thought of using the L3 for a piloted lunar landing was formidable. At a meeting in late July 1971, Minister of General Machine Building Afanasyev, Academy of Sciences President Keldysh, and Ministry Chief Directorate Chief

41 Kamanin 'I Feel Sorry for Our Guys' p 12

42 Among the subcommissions were Subcommission no 1 chaired by MKB Fakel General Designer P D Grushin, Subcommission no 3 chaired by TskB Almaz General Designer B V Bunkin, Subcommission no 4 chaired by USSR Academy of Sciences Vice President V A Kotelnikov and Subcommission no 5 chaired by Deputy Minister of Health A I Bumazyan. TskBEM representatives on the subcommissions included S O Okhapkin and K D Bushuyev (on no 1), M V Melnikov (on no 2), B Ye Chertok (on no 3) and Ya I Tregub (on both nos 4 and 6).

43 There was an additional possibility within the second option to carry out the N1-L3 mission with a single launch. This would, however, only be possible if engineers could increase the lifting capability of the N1 which was still not up to design levels by 1971.

Kerimov all agreed that the original N1-13 complex should not be used for landing a cosmonaut on the Moon. They were even against using the N1-L3 for an automatic landing, as proposed by Mishin earlier. While debate over automated L3 landings continued, the original L3 piloted lunar landing plan received its final death knell at a meeting of the Keldysh Commission on August 16, 1971. It had been almost exactly seven years to the day since the Soviet government had approved Korolev's L3 idea. The question of whether to use the remaining components of the L3 complex was left unresolved. At the same time, TsKBEM would commit its resources to perfecting the L3M plan. Mishin, in fact, signed the preliminary materials for a "prospective" lunar expedition—that is, the new L3M plan—on the same day as the Expert Commission's meeting. He was instructed to have the predraft plan ready by early 1972.

Throughout the latter part of 1971, Mishin's engineers continued evaluating various options for L3M.⁴⁴ This effort included freezing the design of the new descent apparatus with two new parachutes and reexamining the most optimal trajectories to and from the Moon—an exercise that evidently included studying data from the recently completed Apollo 15 mission. Support for the L3M option was growing at the time. Mishin later recalled:

We finally managed to get technical tasking from the USSR Academy of Sciences for a lunar mission [that is, the L3M] with a list of problems that it was supposed to solve. It must be noted that no such specifications had ever been received from the Academy for the first version of the mission [that is, the L3].⁴⁵

The Expert Commission's recommendation and the "technical tasking" of the Academy of Sciences were important factors in providing some much needed impetus to the N1F-L3M proposal. By the end of 1971, Mishin's engineers had evidently completed the detailed draft plan for the project. Even the all-powerful Military-Industrial Commission took an interest, issuing a decree on February 16, 1972, in support of further work on such a project. If obstinate opponents of the N1 such as Chief Designer Glushko opposed the plan early in 1971, they all came around to the same point of view. On May 15, 1972, the Council of Chief Designers for the lunar program formally adopted the N1F-L3M plan, titled "Technical Proposals for the Creation of the N1-L3M Complex." Even Glushko signed the final document.⁴⁶

In contrast to the utter chaos that had pervaded the birth of the N1-L3 in the early 1960s, this new project was not born out of jealous infighting among the chief designers, nor from external political imperatives. For the first time in a major Soviet space project, the pace was not dictated by what the United States was doing. This alone could have made the proposal worth pursuing, but the L3M also had excellent technical characteristics, well-planned schedules, and painstaking cost assessments to back it up. Mishin originally had planned for launches in the new program to begin simultaneously with the winding down of the original L3 project—that is, in 1974. According to preliminary plans in September 1970, there would be two launches in 1974 and four in 1975, the latter perhaps including actual piloted landings. By the time of the May 1972 decision, the timeframe was moved back by about two years, with launches

⁴⁴ For example options explored in late September 1971 included (1) a two-launch scheme with docking in lunar orbit with either (a) a direct flight from the Moon to Earth or (b) with a second docking in lunar orbit and then returning to Earth and (2) a two launch scheme with docking in Earth orbit with either (a) a direct landing on the Moon and direct return to Earth or (b) a plan similar to the original N1-L3 in lunar orbit. One of the more interesting possibilities was using the new 7K S Soyuz variant in lunar orbit.

⁴⁵ Mishin "Why Didn't We Fly to the Moon?"

⁴⁶ *Ibid* Boris Arkadyevich Dorofeyev "History of the Development of the N1 L3 Moon Program" presented at the 10th International Symposium on the History of Astronautics and Aeronautics, Moscow State University Moscow Russia June 20-27 1995

beginning in 1976 and landings in 1977. These latter missions would include initial cosmonaut surface stays lasting fourteen days, leading up to full-fledged lunar surface missions lasting an unprecedented month on the Moon.⁴⁷

What was even more astonishing about the L3M plan was that the Soviets did not stop there. There were even plans for permanent piloted bases on the lunar surface—plans that actually harked back to about 1965. Sometime before his death in January 1966, Korolev had discussed this idea with Chief Designer Barmin of the Design Bureau of General Machine Building. Although Barmin's main line of work was the design and development of ground launch complexes for Soviet missiles and launch vehicles, he was sufficiently interested in the topic to take on a modest subcontract from OKB-1 to explore the design of permanent lunar bases. These studies continued well after Korolev's death. Mishin's TsKBEM remained in overall charge of the research, but cooperated with Barmin's design bureau in formulating the goals of the base, the principles of construction, the stages of development, and the composition of scientific and special manufacturing equipment. Barmin's engineers also studied civil engineering methods, questions of life support systems and their maintenance, and power supply and radio communications systems.⁴⁸

The overall effort was generically called the Long-Duration Lunar Base (DLB) and consisted of several different thematic directions with names such as *Kolumb* ("Columbia"), *Bolshoye koltso* ("Big Ring"), *Dal* ("Distance"), and *Osvoyneniye* ("Mastery"). Engineers designed a veritable menagerie of various insect-like vehicles for work on the lunar surface, including:

- Vehicles equipped with radio beacons (whose design was based on the Ye-8 descent stage), which would guide spacecraft down to specific landing sites
- Huge "closed" lunar rovers with pressurized compartments for crews to collect samples using long and jointed remote manipulator arms without leaving the comfort of their cabin
- Large utility vehicles for transporting vast amounts of raw materials across the lunar surface
- General crew mobiles capable of sustaining independent forays for days at a time
- Different automated rovers equipped with core-drilling manipulators built by Barmin's engineers for gathering soil samples

The L3M lander would serve as the initial transport vehicle to the lunar surface, and later NIs would bring the remaining assortment of rovers and beacons, many of which would be built by the Lavochkin Design Bureau—an appropriate choice given its experience in designing automated lunar and interplanetary probes. Long-term plans included mining the Moon for helium-3, hydrogen, oxygen, silicon, titanium, aluminum, and iron for various manufacturing and industrial processes. For the actual bases, Barmin considered different alternatives. In one conception, the cosmonauts would live underground to efficiently use sublunar heat-exchange processes. The actual production structures, landing sites for transport rockets from the Earth, and refueling stations would be located far away from these laboratories, but they would be connected via special tunnels, either by foot or by means of moving "strips" similar to those in airports today. Another option studied was to have residential and operational structures on the surface with dome-like protective coverings built from transparent material. The entire complex would contain perhaps three habitation modules, equipment for the production of oxygen and other gases, installations for the extraction and transportation of lunar materials, and a nuclear-type power plant.⁴⁹

47 Mishin "Why Didn't We Fly to the Moon?"

48 Yu A. Mozzhorin *et al.* eds *Dorogi v kosmos 1* (Moscow MAI 1992) p 55

49 Mikhail Rebrov "Touching Upon the Legend of the DLB" (English title) *Krasnaya zvezda* June 18, 1994 p 6



Small models of elements of the Long-Duration lunar Base (DLB) are shown here in a museum display case. Note the models of the N1-L3 LK lunar lander at the left of the photograph. At least one of Babakin's Ye-8 descent stages is visible at center right. Several large mobile "crawlers" are placed at the top from left to right (copyright Mark Wade)

All of these proposals, for both the L3M and the DLB, were, of course, restricted by the realities of the day, primarily financial ones. Neither had, by 1972, received formal approval from the Council of Ministers and the Central Committee. Sanction from the Soviet leadership would prove difficult, but given the multiple recommendations in favor of the L3M, it was not thought to be impossible. All would depend on the success of the remaining launches of the older N1 model. Their success would be critical to convincing the Soviet leadership that the N1 rocket project was an effort worth pursuing and funding for the long run. Awaiting a formal decision on the L3M, Mishin elected to doggedly continue to flight-rate the older LOK and LK spacecraft, because much of the technology from these vehicles would be used in upgraded form on the L3M. Thus, if his plans were approved, the Soviets would fly the remaining L3 hardware to the Moon by the mid-1970s, begin the advanced L3M missions by the late 1970s, and then slowly move to the DLBs by the first years of the following decade, possibly initiating the first colonization of the Moon.

Ironically, at the very same time that the Soviets were conceptualizing such grand projects, the U.S. civilian space program was suffering from post-Apollo malaise. In its early days, NASA had been well equipped to cope with repeated failures of its rockets and satellites, but in the aftermath of Apollo 11, it was unable to cope with success. Having been a single-issue agency, NASA leaders were facing the problem of using dwindling financial and human resources to create a tenable vision of the future. One of the most compelling components of this new vision was to create the means for "routine access to space"—that is, a shuttle vehicle that would service future space stations and haul scientific and applications satellites into space. Initially, in the fall of 1969, NASA had hoped that President Richard M. Nixon would approve an ambitious plan to build a space station, the Space Shuttle, and a piloted Mars project. As the financial realities sank in, this aggressive plan was reduced ultimately to just the Space Shuttle, which itself was redesigned several times to meet budget limitations, thus sacrificing much of its original *raison d'être*—that is, "routine access to space." In January 1972, Nixon met with NASA Administrator James C. Fletcher and issued a statement announcing the decision to "proceed at once with the development of an entirely new type of space transportation system designed to help transform the space frontier of the 1970s into familiar territory, easily accessible for human endeavor in the 1980s and

'90s."⁵⁰ Without a space station or a Mars mission, the United States was left with a plan of pilot-ed space exploration that was lacking in a concrete vision, a means that had no end. At the same time, the Soviet Union was dramatically planning to up the ante, squarely targeting the Moon and building new space stations, including both the small DOS and the giant MKBS.

Building the *Salyut* Long-Duration Orbital Station

The Long-Duration Orbital Station, better known by its acronym "DOS," was designed, built, and tested over a remarkably short period of time. Not surprisingly, the mainframe of the station was identical to Chelomey's Almaz station—that is, roughly shaped like three cylinders of different diameters connected end on end. For the DOS (or product 17K), this design was augmented by a fourth cylinder. The total length in orbit was about 16 meters. From the station's forward end to its rear, the "cylinders" of the 18.9-ton station were the:

- Transfer compartment
- Working compartment (consisting of two of the "cylinders")
- Aggregate compartment

The transfer compartment at the forward end was equipped with the passive docking node for receiving Soyuz ferry vehicles. The length of this section, including the node, was three meters, and the diameter was two meters. This compartment primarily contained equipment for life support and thermal regulation. The major scientific component was the Orion-1 ultraviolet telescope, which included a locked chamber for removable photo cassettes. Part of the telescope, designed by the Byurakan Astrophysical Observatory, jutted out of the compartment in a hemispherical depression embedded on the outside of the section. Other equipment included cameras and biological instrumentation. The short compartment also included an eighty-centimeter-diameter hatch for allowing crews to egress from the station for spacewalks. On the exterior of the compartment, there were two large solar panels fixed like bird wings, each with four paneled sections. With a wingspan of eleven meters, these were created on the basis of the solar panels on the 7K-OK Soyuz spacecraft. Other equipment on the exterior of the transfer compartment included the Igla rendezvous system antennas, lights for docking approaches, one of two external TV cameras, panels for heat regulation, ion sensors for the attitude control system, and panels for micrometeoroid detection.

Swimming from the Soyuz into the transfer compartment, a cosmonaut would open a second hatch and then enter the working compartment, the largest portion of the station. Its two cylinders of different diameters were connected via a conical transfer section. The smaller cylinder had a diameter of 2.9 meters and a length of 3.8 meters, while the measurements for the larger cylinder were 4.15 meters and 2.7 meters, respectively. The smaller diameter section contained the central command post for controlling the station with a control panel and on-board computers. The control system for the station was derived from the original 7K-OK Soyuz system, a measure adopted to eliminate extra effort. One movie camera and one still camera were installed on the "upper" wall of the section, allowing direct access to the outside. The small diameter area also contained a table for work and eating, facilities for heating food, drinking water, on-board documentation, a tape recorder, a library, a sketch album, and other items.

⁵⁰ John M. Logsdon "The Evolution of U.S. Space Policy and Plans." in John M. Logsdon, ed. with Linda J. Lear, Janelle Warren Findley, Ray A. Williamson, and Dwayne A. Day, *Exploring the Unknown: Selected Documents in the History of the U.S. Civil Space Program, Volume I: Organizing for Exploration* (Washington, DC: NASA Special Publication (SP) 4218), pp. 386-88. Roger D. Launius, *NASA: A History of the U.S. Civil Space Program* (Malabar, FL: Krieger Publishing Co., 1994), pp. 107-10.

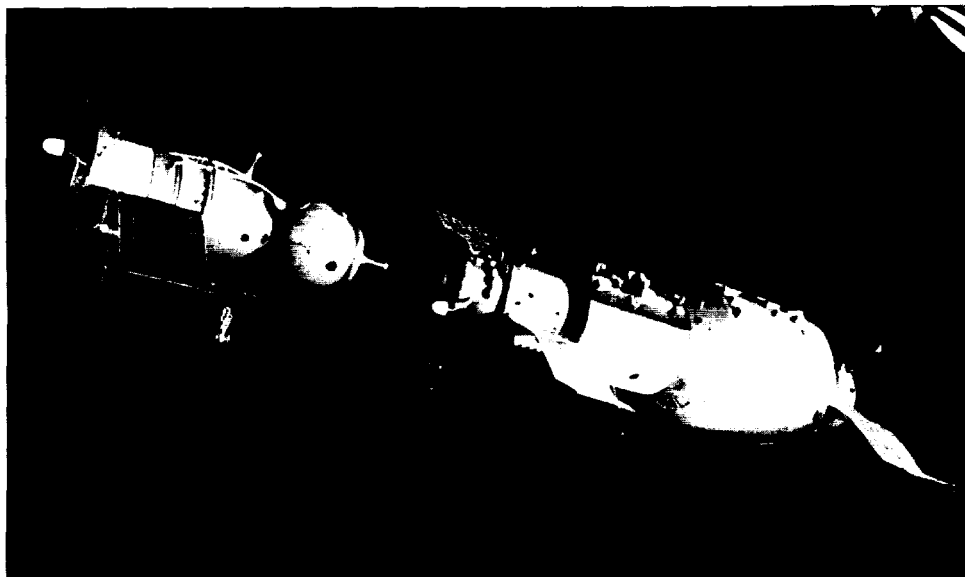

Here is a model simulation of a 7K-T Soyuz spacecraft (left) docking with the early model of the DOS space station (Salyut) (NASA photo)

Moving aft, a cosmonaut would then enter the large diameter area. The primary equipment here was a large cone with its base on the "floor" and its apex almost to the "ceiling"; it was called the scientific apparatus compartment. The latter consisted of, among other instruments, the OST-1 two-meter-diameter solar telescope designed by the Crimean Astrophysical Observatory. At the rear of the large-diameter area, there were three posts for work on other scientific apparatus, which included the *Anna-3* gamma-ray telescope, the TEB telescope for studying charged particles in the upper atmosphere, the *Kalina* ("Viburnum") instrument, and the FEK-7A photo-emulsion camera. Other scientific instrumentation on the station included the RT-4 Roentgen telescope built by the Physical Institute of the Academy of Sciences, the ITSK infrared telescope-spectrometer, and the OD-4 optical visor instrument. The AFA-41/20 and AFA-M-31 cameras were for Earth resources surveys. Disciplines apart from Earth observation and astrophysics were also represented. There was a virtual menagerie of medical instrumentation with their own enigmatic names: *Polinom-2M*, *Levkoy-2M* ("Gillyflower"), *Tonorometr*, *Rezeda-2M* ("Mignonette"), *Impuls* ("Impulse"), *Vertikal-M* ("Vertical"), *Plotnost* ("Density"), *Raduga* ("Rainbow"), and *Kreslo* ("Seat"). During exercises, the cosmonauts would wear the *Atlet* ("Athlete") suit, while at other times they would don the *Pinguin* ("Penguin") suit, which would force the crew to act against allowing the suit to assume its normal fetal position. In addition, the *Chibis* ("Lapwing") was a special "suit" designed to generate negative pressure on the lower body to reduce orthostatic intolerance during the return to Earth. Finally, there was also a special "antigravity" suit for the cosmonauts to wear before the end of the mission. The total mass of all scientific devices on the station was one and a half tons.

The large-diameter area also contained sleeping areas for the cosmonauts, physical trainers (including a stationary running track capable of ten kilometers per hour and a "vele-ergometer"), a refrigerator with a supply of food products and water, and a toilet with its own forced ventilation system isolated from the rest of the station. All around the large-diameter area, there were panels on the walls giving easy access to instrumentation for controlling the station—those for life support, thermal regulation, power supply, radio communications.

trajectory measurement, and command radio links. So as not to disorient crews in space, the station had a specific color scheme: the front and rear were light gray, one side was apple gray, the other wall was yellow, and the "floor" was dark gray. The exterior of the working compartment had various antennas from the station's radio complex and micrometeoroid impact panels.

The DOS contained seven specific locations for manually controlling the scientific apparatus and station systems. Station no. 1, the central command post of the station, was located in the lower part of the small-diameter portion. Equipped with two chairs, cosmonauts could control the basic on-board systems and part of the scientific equipment from here. Station no. 2, the "astropost," was also located in the small-diameter area: it was designed for manual astro-orientation and astro-navigation. Station no. 3 was in the large-diameter section and was exclusively for controlling the scientific apparatus. In addition to scientific research, Station no. 4 was for medical investigations and was located in the conical section between the small- and large-diameter sections. Station no. 5 was specifically for controlling the Orion-1 stellar telescope and was located in the transfer compartment. Station no. 6, like Station no. 2, was for astro-orientation and navigation; it was located in the small-diameter section. Finally, Station no. 7 was for controlling scientific apparatus focused on studying "atmospheric resonance" using the ERA instrument and was located opposite to Station no. 6.

The final section of the station was the aggregate compartment at the very aft end of the DOS. Not accessible by the crew, this compartment was a simple cylinder with a diameter of 4.15 meters and a length of 1.4 meters hooked to a semispherical shell attached to the station proper. The cylindrical portion was appropriated directly from the aggregate compartment of the Soyuz spaceship, and it contained the main maneuvering engine of the space station, the 55.66. The engine, almost identical to the Soyuz main engine, was developed by the same enterprise that had developed the one for Soyuz. Chief Designer Isayev's Design Bureau of Chemical Machine Building (formerly OKB-2). The 55.66 had a primary single-chamber engine with a thrust of 417 kilograms and a reserve two-chamber one with a thrust of 411 kilograms. In addition to the main engine, the station was equipped with a set of thirty-two small attitude control thrusters of ten kilograms thrust each, developed by the Scientific-Research Institute of Machine Building based at Nizhnyaya Salda. The attitude control complex consisted of two independent systems—a primary and a backup—each consisting of sixteen engines (six for yaw, six for pitch, and four for roll). The propellant tanks for these engines were installed in the aggregate compartment.

Two large solar panels, identical to the ones at the forward end of the station and derived from the Soyuz spacecraft, were installed on the aggregate compartment, lending the station a bird-like appearance. Electrical energy for the station was passed through independent systems—the SEP-1 and SEP-2—each with a potential difference of twenty-seven to twenty-eight volts. These could work simultaneously using the two pairs of solar panels, with a total surface area of twenty-eight square meters, to charge two internal nickel-cadmium batteries. SEP-2 was designed for intermittent work and was only for the scientific instrumentation."

From an overall perspective, the DOS spacecraft was essentially created by combining the Almaz space station with the Soyuz spaceship. The number of systems appropriated from the latter were numerous, including the entire orientation and approach control systems, the Zarya radio-communications systems, the RTS-9 telemeasurement system, the Rubin orbital radio-

51. I. Marinin, "Quarter Century for 'Salyut'" (English title), *Novosti kosmonavtiki* 10 (May 6-19, 1996), 78-84; Lardier, *L'Astronautique Sovietique*, pp. 199-202; V. P. Glushko, ed., *Kosmonavtika entsiklopediya* (Moscow: Sovetskaya entsiklopediya, 1985), pp. 343-44; M. P. Vasilyev, et al., eds., *'Salyut' Space Station in Orbit* (Washington, DC: NASA TT F-15450, 1974), pp. 3-8. This last source is a translation of M. P. Vasilyev, et al., eds., *'Salyut' na orbite* (Moscow: Mashinostroyeniye, 1973).

control system, the DRS command radio-link system, the central pilot control panel, the Igla rendezvous system, and the life support systems. The thermo-regulation system used on the DOS was an updated version of the one on Soyuz. There was widespread cooperation in the building of the DOS. Apart from TskBEM. TskBM's Moscow Branch, and the M. V. Khrunichev Machine Building Plant, numerous other organizations contributed to the rapid pace of progress.⁵²

One of the essential components of creating the DOS-7K complex was developing a ferry version of the Soyuz spacecraft, which would ensure internal crew transfer after docking. The original Soyuz docking system was, of course, designed in such a way as to precisely prevent such internal passage. By late 1969, TskBEM had begun redesigning the 7K-OK Soyuz into the "new" 7K-T Soyuz specifically for the DOS program. In early 1970, Department No. 231 at the design bureau issued the draft plan for the ferry vehicle under the overall leadership of Deputy Chief Designers Bushuyev and Tsybin. The 7K-T ship had an active docking unit with a rod compatible with a cone on the passive docking node on the DOS ship. Given the rapidity with which Mishin's engineers managed to design a complex docking mechanism capable of internal crew transfer, it is quite likely that they used the experience in creating a similar mechanism for the "advanced" but still-not-yet-flown 7K-S variant of the Soyuz. The Azov Machine Building Plant carried out the manufacture of the new docking mechanism, which had a 0.8-meter-diameter hatch.

Unlike the basic Soyuz, the 7K-T had a simplified life support system because it did not need to ensure autonomous flight for very long. The systems related to the Igla rendezvous system were transferred to the living compartment at the forward end of the ship, and one of the command radio links was removed completely, allowing for the elimination of the toroidal compartment around the engine unit at the rear of the original Soyuz. The 7K-T transport ship had a launch mass of 6,700 kilograms, which was about fifty kilograms in excess of its predecessors; its descent apparatus weighed 2,800 kilograms. As a whole, the ship was 6.98 meters in length. The vehicle would be capable of carrying three cosmonauts without pressure suits and return only twenty kilograms of scientific results back from the station, suggesting that the Soviets were pushing the upper limits of what they could squeeze out of the Soyuz booster-spacecraft system at the time. The new Soyuz was rated for sixty days of flight time, of which three days would be autonomous. In a clear departure from previous Soviet practices, TskBEM elected to forego automated missions of the 7K-T Soyuz and go directly to piloted launches."

If the DOS program had, at least in the initial phases, a temporary feel to it, by the end of 1970, TskBEM had tabled several ambitious plans to extend its capabilities far beyond its modest origins. One crucial design issue was the addition of a second docking node to allow resupply visits to the station. Mishin recalled later that he had proposed the use of two docking ports on the very first DOS vehicle, but he had been overruled by Ustinov "in order to hasten our success."⁵⁴ By May 1970, engineers apparently planned for the second DOS to have two docking ports, allowing for visits simultaneously by two "advanced" 7K-S Soyuz vehicles. Changes crept into the plan in the subsequent months. In a preliminary conception of the five-year space plan for the Soviet Union covering 1971 to 1975, prepared in late September 1970,

52. Semenov, ed., *Raketno-Kosmicheskaya Korporatsiya*, p. 268. The other organizations included VNII Televideniya under I. A. Rosselevich (for TV systems), MNII Radiosvyazi under Yu. S. Bykov (for communications systems), KB Nauka under G. I. Voronin (for life support systems), KB Zvezda (for spacesuits), TskB Geofizika under V. A. Khrustalev (for attitude control sensors), OKB MEI under A. F. Bogomolov (for telemetry systems), IMBP under O. G. Cazenko (for biomedical support), VNII IT under N. S. Lidorenko (for power sources), VNII EM under A. G. Iosifyan (for remote-sensing equipment), and NII KhimMash under N. M. Samsonov (for ground testing)

53. Ibid. p. 187; Marinin, "Quarter Century for 'Salyut'."

54. A. Tarasov "Missions in Dreams and Reality" (English title), *Pravda*, October 20, 1989, p. 4.

the Soviets were tentatively visualizing the launches of ten such space stations over the course of five years—that is, two per year. By this time, the *third* DOS vehicle would be the first standard model with two docking ports; the remaining vehicles would all be identical save for the internal complement of scientific equipment. The DOS number 3 would also be the first station to be serviced by the 7K-S Soyuz. Work on the second DOS had already started by the end of 1970, before the launch of the first DOS, with work advancing to the crew selection stage. Apart from the basic Almaz-based DOS model, Mishin's engineers also conceptualized much more advanced versions. In early September 1970, Ustinov visited TskBEM to hear reports on the progress of the DOS program and, at least tentatively, approved "prospective" developments, specifically a station named the DOS-N, to be launched by an uprated N I rocket. Later, in March 1971, Mishin reported to Ustinov on another DOS variant, the DOS-A, evidently proposed as a direct competitor to NASA's Skylab space station, which was far larger than the original DOS variants based on Almaz.

The DOS program may have been primarily a politically motivated program, but there was much debate over what kind of scientific instrumentation to have on the station. In July 1970, Mishin spoke with Academician Georgiy I. Petrov, the Director of the Institute of Space Research under the Academy of Sciences, to discuss the possibility of installing a radio telescope with a fifteen-meter-diameter parabolic antenna on a DOS. Later in the month, Mishin also sent a letter to various scientific (and probably military) organizations asking what kind of goals they would like to be solved on the station—a significant change from the haphazard nature of scientific research on piloted space missions throughout the 1960s. In early February 1971, Mishin met with Viktor A. Ambartsumyan, a Vice President of the Academy, to discuss the long-term scientific goals of the DOS. Several requirements were established:

- The Soviets needed a program for space-based astronomy research.
- Resources were needed for creating optical and radio telescopes in Earth orbit.
- Four of the future DOS vehicles should be equipped with telescopes of 1 meter in diameter for astronomy research.
- A space-based parabolic antenna should be developed with a diameter of thirty to fifty meters.
- A telescope with a mirror of three meters diameter should be created for seven to eight years of operation in orbit.

While all of these were not intrinsically related to the DOS, the space station program seems to have served as a catalyst for this new cooperation between the scientific and space communities.

Crews for the first DOS were slow to train for the first space station missions because of the inevitable acrimony over crew selection that had continuously plagued the Soviet piloted space program. On April 23, 1970, Mishin had initially proposed a set of four crews for the two planned missions to DOS-1. Not surprisingly, Air Force representative Col. General Kamanin refused to approve the choices. He believed that one man, TskBEM civilian engineer Feoktistov, was not medically suited for flight. Feoktistov had also recently been divorced from his second wife, which would make him unsuitable for space flight. Another man, Air Force Colonel Volynov, who had earlier flown the Soyuz 5 mission, was unacceptable to Kamanin because he was Jewish. Kamanin had been instructed by Ivan D. Serbin, the chief of the Defense Industries Department in the Central Committee, not to allow Volynov to fly again. Finally, a third man, Air Force Colonel Khrunov was deemed inadequate because of his behavior after a recent hit-and-run accident in which he had failed to come to the help of the victim. After a major reshuffle of the crews, Kamanin and Mishin agreed to four new crews on May 13. The first two crews who would fly the first space station missions were: (1) Shonin, Yeliseyev, and Rukavishnikov and (2) Leonov, Kubasov, and Kolodin.

Both commanders and flight engineers were veterans of previous missions. Leonov, in particular, had finally terminated his training for piloted lunar missions in May 1970 after close to four years of work. Different members of the crews began their training at various points in 1970, but the two main crews plus a third backup crew did not begin integrated training until September 18, 1970, a few scant months prior to the expected launch of the first DOS. The fourth crew, who were not actually expected to fly, but whose commander would play an important role in the history of this first space station program, did not even begin training until January 1971.⁵⁵

From the outset of the DOS program, it was clear that the Soviet space bureaucracy was managing this program with much more verve than its lackluster performance during the piloted lunar programs. There were regular meetings at the highest levels to assess the pace of preparations with necessary actions to compensate for potential delays. Publicly, Soviet spokespersons were claiming left and right that the future of space travel depended squarely on the development of Earth-orbital space stations. But these words would have to be backed up by actions. In late August 1970, word came down from the Central Committee that the first DOS article would have to be launched in time for the 24th Congress of the Communist Party of the Soviet Union, to be held in the spring of 1971. Later, in September, Minister Afanasyev called Mishin to ensure that the launch would be in January 1971 before the opening of the Party Congress, thus distinctly linking socialist doctrine with the Soviet expansion into space.

On September 23, 1970, Ustinov presented Mishin with a deadline for the launch of DOS-1—February 5, 1971—that is, a few weeks before the Congress. According to the plan, ground testing of the station would be complete by December 10, and the station would be taken to Tyura-Tam January 1–10, 1971. The timing with the Party Congress significantly upped the ante of the program. Afanasyev personally visited the Khrunichev Machine Building Plant on October 1, demanding that engineers complete the assembly of the first flight vehicle within forty-five days. Despite assurance from the leading officials at the plant that this would be impossible, Afanasyev did not back down. Working overtime, the workers at the plant eventually managed to fulfill the minister's demands, completing the manufacture of the first DOS by the end of November 1970. The assembled station was then transferred to TsKBEM for final ground testing.⁵⁶ Despite the hectic pace, there were delays. By mid-November, it was clear that Ustinov's schedule would not stand. On December 21, the first State Commission meeting for the DOS-7K complex took place in Moscow. The launch was postponed to March 15, 1971, still just a scant twelve months after the DOS program had been inaugurated. One issue of discussion during this period was the length of the two missions to DOS-1. Based on the resources of the station, Mishin had originally envisioned the first lasting thirty days and the second forty-five days. Several cosmonauts met with the chief designer in October 1970, proposing that the first flight be shortened to twenty to twenty-two days—a request apparently based on the abysmal condition of the Soyuz 9 crew after returning from their eighteen-day mission. The length issue was discussed at the State Commission meeting on December 21, but it was left unresolved because of opposition from Kamanin on performing a thirty-day mission.⁵⁷

55. Marinin, "Quarter Century for 'Salyut' "

56. *Ibid.* S. A. Zhiltsov, ed., *Gosudarstvennyy kosmicheskyy nauchno-proizvodstvennyy tsentr imeni M. V. Khrunicheva* (Moscow, RUSSLIT, 1997), p. 76; Semenov, ed., *Raketno-Kosmicheskaya Korporatsiya*, p. 269. TsKBEM engineers designed several models of the DOS apart from the flight model. These included a unit for working on the assembly of the payload fairing, a heat model for creating the thermo-regulation and life support systems, a unit for working on the engine system, an antenna model for checking the directions of the antennas of the radar system, and the designers' model for installing instruments.

57. Marinin, "Quarter Century for 'Salyut'."

The stage was set for the Soviet revenge on Apollo. The leap that the Soviets took in 1971, however, proved to be of a different nature. It was a story mired in the most bitter of ironies, the most dramatic of events, and certainly the most tragic of consequences.

Salyut

On February 5, 1971, just over a month prior to the scheduled launch of DOS-1, Air Force Colonel Georgiy S. Shonin, the commander of the first space station crew, did not report to training at the Cosmonaut Training Center. Kamanin personally took over the investigation and found to his surprise that this was not the first time that there had been such an absence. After further investigations, he found that Shonin had, without authorization, checked into a hospital for an unspecified "illness," which had come to light after a recent trip to the Tyura-Tam launch site. Leonov, the commander of the second crew, made a vain attempt to defend Shonin's actions, but it was too late. When Mishin discovered this lapse in training, he immediately asked Kamanin to dismiss Shonin from the mission and, in "a fit of temper," proposed an all-civilian crew to fly the first mission. In the end, Mishin backed down on his all-civilian proposal, and Kamanin removed Shonin from the primary crew. The "ill" cosmonaut was sent off to Burdenko Hospital and was found to have an unstated "reactive condition" as well as "psychological faults." Shonin, one of the original 1960 group of cosmonauts with Cagarin, never flew another space mission, although it seems that he recovered from this censure and trained again for space missions in the late 1970s."

On February 12, Kamanin named revised crews for the first missions, inserting two-time veteran Shatalov as the commander of the first mission. It could not hurt that Shatalov was the only cosmonaut in the entire detachment who had experience in docking in space. With the hapless Shonin gone, the first two crews to the DOS became: (1) Shatalov, Yeliseyev, and Rukavishnikov and (2) Leonov, Kubasov, and Kolodin. The third and fourth crews were accordingly shuffled. In a switch that only had meaning in retrospect, the third crew—essentially a back-up crew for the two primary crews—was Dobrovolskiy, Volkov, and Patsayev." None of them expected to fly. In fact, Dobrovolskiy had only begun training in January 1971.

The frantic pace of preparing the space station began to catch up with its developers, as errors and delays crept into the preparations. On March 2, 1971, a readiness review meeting of the Council of Chief Designers took place, during which significant delays were acknowledged. There had been continual postponements in vibration testing of the station flight article, while serious malfunctions had cropped up in the ground testing of the Igla docking system to be used on the Soyuz transport spacecraft. Of four Igla systems built by the Scientific-Research Institute for Precision Instruments, three had failed testing; the fourth was working only marginally. Furthermore, there were also major delays in the packing of the parachutes in the Soyuz capsule and the testing of the station's life support system. The flight version of the DOS had arrived at the Baykonur Cosmodrome in March 1971, allowing engineers to begin a forty-day working cycle to test the product. Here, engineers had to perform their tasks almost by a seat-of-the-pants approach, with makeshift equipment doing tasks that required "difficult physical work." Mishin arrived at the launch site in late March, noting that many instruments had been removed from the station and that there had been mistakes during the assembly of ground systems. The delays

58 *Ibid* Shonin trained for a military Transport Supply Ship (TKS) mission in 1977-79 before officially resigning from the cosmonaut team on April 28 1979. The all-civilian crew that Mishin proposed was Yeliseyev, Kubasov, and Rukavishnikov.

59 S. Shamsutdinov and I. Marinin "Flights Which Never Happened" (English title) *Aviatsiya i kosmos* *avtika* no 3 (March 1993) 43-44.

60 Semenov ed. *Raketno-Kosmicheskaya Korporatsiya* p. 269.

meant that the launch was delayed by another month, April 15 at the earliest; the Shatalov crew would be launched on April 18–20 to begin the first space station occupation.

Originally, Mishin had decided to call the station Zarya ("Dawn") in the open press, but at some time immediately prior to the launch, there was some discussion on the issue. Apparently, the Chinese had used the same name for one of their satellites. Instead, Mishin himself suggested at the launch site that the station be renamed Salyut ("Salute") as a mark of respect for the late Yuriy A. Gagarin, the tenth anniversary of whose historic space mission was also in April 1971. The original Zarya name remained inscribed on both the station and the Proton rocket's payload fairing because it was too late to change it.⁶¹

The three main crews training for the flight were in the process of finalizing their training program by March 1971, although there was still no final word on the length of the first mission—twenty to twenty-two days or thirty days. The overwhelming feeling was that the State Commission would vote for the latter. Mishin had evidently spoken at length with representatives of the Institute for Biomedical Problems on the issue, and he had decided that thirty days would not do significant harm to the human body. On March 16, the cosmonauts took their final exams, all of them doing splendidly, confirming their full preparedness for the mission. During a meeting on March 19, the State Commission adopted a final decision to launch the station between April 15 and 18. The cosmonauts themselves flew into Baykonur on March 20 to acclimatize themselves with prelaunch preparations at the Kosmonavt Hotel. They were witnesses to another failure during testing of the Igla rendezvous system, and one wonders whether their morale was not affected by the accumulating errors. After a brief training period, they returned to Moscow. Shatalov and Yeliseyev attended the 24th Congress of the Communist Party, which opened on March 30. Five days earlier, the Military-Industrial Commission formally approved plans for the two missions to the station.⁶²

The cosmonauts, Air Force officials, and many other industry representatives returned to the launch site on April 6. Three days later, the State Commission, headed by Ministry of General Machine Building representative Maj. General Kerimov, approved the launch of the DOS ship, spacecraft no. 121, on April 19. There were no major delays or unexpected occurrences during the last days leading to the launch. In anticipation of the launch, the Soviets, in their customary manner, dropped hints of an impending spectacular. On March 14, the anonymous "Chief Designer of Spaceships"—that is, Mishin—declared in an interview with the Moscow economic daily *Sotsialisticheskaya industriya* (*Socialist Industry*), that the Soviet Union was preparing to launch another piloted spacecraft for a long-duration mission as a prelude to building a permanent Earth-orbiting space laboratory.⁶³ The world did not have long to wait. At 0440 hours Moscow Time on April 19, 1971, a three-stage Proton booster successfully lifted off from site 81 with its precious payload, DOS-1. The initial orbital parameters for the station, called Salyut in the press, were 222 by 200 kilometers at a 51.6-degree inclination. By the end of the first orbit, ground controllers discovered that the large cover on the exterior protecting the scientific apparatus compartment—that is, the OST-1 telescope—had not been jettisoned, thus jeopardizing the scientific value of any visiting expedition. Apparently, the explosive devices for the cover had failed to fire. During the second day of flight, there were also failures

61. *Ibid.*, p. 70; V. M. Petrakov, "Soviet Orbital Stations," journal of the *British Interplanetary Society* 47 (September 1994): 363–72. Another source suggests that the name change was because Zarya was also used as a call sign for the ground segment of the Soviet Command-Measurement Complex, thus raising the possibility of confusion between the station and Earth during communications sessions. See Dmitriy Payson, "Without the 'Secret' Stamp: 'Salyut' and Star Wars" (English title), *Rossiyskiye vesti*, November 21, 1992, p. 4.

62. Маннин, "Quarter Century for 'Salyut'" The commission approved the plan for a thirty-day flight for the first mission and a possible forty-five-day for the second one.

63. Theodore Shabad, "New Manned Orbital Flight Seen," *New York Times*, March 15, 1971, p. 17.

of two ventilation units used for the life support system, although this seems not to have caused any major concern on the ground.⁶⁴

The day after the *Salyut* launch, the primary crew for the first mission was presented to the Soviet press, with the accompanying announcement that their launch would take place on April 22 at 0320 hours Moscow Time—a night launch. Shatalov, Yeliseyev, and Rukavishnikov took their places in their Soyuz spacecraft, despite some concern with respect to heavy showers during the night: the State Commission, however, agreed to proceed with the launch. The Soyuz launch vehicle was filled with propellant, and all prelaunch procedures seemed to be going according to schedule until T minus one minute. At that point, one of the masts on the launch system did not retract as planned. Officials feared that if there was a launch, the launch escape system would be spuriously activated and cause an explosion, as had occurred during a Soyuz launch in December 1966.⁶⁵ Mishin opted to reluctantly postpone the launch. The commission quickly decided to keep the booster on the pad fully fueled and try again the following day.

During the second launch attempt, the exact same thing occurred again; a mast from the launch structure refused to retract. Mishin was apparently aware of the reasons for this deviation from normal procedures, and he took control of the situation. Taking complete responsibility for any negative consequences, he called out for the launch to proceed. There were no problems, and the first 7K-T Soyuz spacecraft, vehicle no. 31, lifted off at 0254 hours on April 23, 1971, with its three-cosmonaut crew of forty-three-year-old Colonel Vladimir A. Shatalov (commander), thirty-six-year-old Aleksey S. Yeliseyev (flight engineer), and thirty-eight-year-old Nikolay N. Rukavishnikov (test engineer). Shatalov and Yeliseyev were the first Soviet cosmonauts to make a third spaceflight, having flown their first missions just two years before. Rukavishnikov, the only rookie on board, had extensively trained for the LI lunar program in the late 1960s. The vehicle, named *Soyuz 10* by the press, entered a nominal orbit of 209.6 by 248.4 kilometers at a 51.6-degree inclination.

Despite a successful launch, the prognosis for the mission was dim. The lid on the scientific compartment was still lodged in its place and threatened to sabotage at least 90 percent of the scientific experiments program. Furthermore, of the eight ventilation units in the life support system, six had failed, raising the prospect of an internal atmosphere full of carbon dioxide and "other harmful materials." During *Soyuz 10*'s fifth and sixth orbits, there were difficulties in modifying the ship's orbit to intersect with that of *Salyut*. The first time, there was an error in the programming logic of the command, while the second time, the burn was abandoned because of insufficient time to prepare. *Soyuz-10*'s ionic orientation system was apparently inoperational because of contamination of the optical surfaces. Shatalov eventually took control of the situation and asked for permission to manually change the orbit, which he did without any problems.

The following morning at a distance of sixteen kilometers from the station, Shatalov switched on the Igla system, which successfully brought the *Soyuz* to within 180–200 meters of *Salyut*. At that point, he took over manual control, successfully linking up at 0447 hours on April 24. About ten to fifteen minutes following soft-docking, Shatalov radioed to the ground that the docking indicator light was not on in the *Soyuz*, suggesting that hard-docking had not taken place. Ground telemetry confirmed that full docking had not occurred and that there was still a nine-centimeter gap between the two vehicles. Shatalov attempted to tighten the two ships by firing the *Soyuz* engines, but this did not prove successful. On their fourth orbit together, orders

64 I. Marinin, "Quarter Century for Salyut Part II" (English title) *Novosti kosmonavtiki* 11 (May 20–June 2, 1996) 46–51; Petrakov, "Soviet Orbital Stations."

65 There was a launch failure on December 14, 1966, when a Soyuz (or 11A511) booster exploded at site 31 at Tyura Tam, killing one person and injuring many. The payload was an automated Soyuz spacecraft.

66 Marinin, "Quarter Century for Salyut Part II."

were received from the ground to try and undock the Soyuz 10 spacecraft and attempt a redocking. At this point, the crew ran into "incredible difficulty" in trying to undock from the station.⁶⁷ On the fourth orbit of combined flight, Shatalov attempted to unlatch the Soyuz 10 ship from the *Salyut* station, but the spacecraft refused to dislodge. The problem was not taken lightly because such a situation could lead to the loss of the station—and perhaps the crew as well. Being unable to undock by normal means, there were two options: (1) dismantling the docking apparatus, detaching it from the Soyuz, and moving away from the station or (2) detaching the spheroid living compartment from the Soyuz spacecraft and separating, thus leaving the living compartment docked to *Salyut*. In both cases, the station would be unusable in the future because the single docking node would be occupied. The situation was compounded by the fact that there was only a limited amount of oxygen left in the Soyuz spaceship (about forty hours), within which time all of this would have to be done. Luckily for everyone, on the fifth orbit of combined flight at 1017 hours on April 24, Shatalov once again tried to undock and was successful. The two spacecraft had been docked for five and a half hours.⁶⁸

Shatalov maintained station-keeping distance from *Salyut* as ground control debated whether to attempt a second docking with the station. After assessing the state of the on-board gyroscopes, propellant levels, and internal air, the Chief Operations and Control Group at Yevpatoriya, headed by TsKBEM Deputy Chief Designer Tregub, decided to abandon the mission and prepare for an emergency return to Earth. Before leaving the vicinity of the station, the Soyuz 10 crew flew around *Salyut* and photographed the docking node to assist engineers on the ground in determining the cause of the malfunction." The crew successfully landed without incident at 0240 hours on April 25, 120 kilometers northwest of the town of Karaganda in Kazakhstan. It was the first-ever night landing in the Soviet human space program. The mission had lasted only one day, twenty-three hours, forty-six minutes, and fifty-four seconds. While the Soviet media at the time characteristically claimed that entry into the station was not even on the agenda and all the objectives of the flight had been successfully achieved, the mission had clearly been a bitter disappointment.

The investigation into the Soyuz 10 failure was completed by May 10, by which time engineers ascertained that the Soyuz docking apparatus had been damaged during the docking maneuver. There had been a breakdown in the coupling shock-absorbing claws in the active part of the docking node when the two ships had attempted hard dock. The system had been subjected to 160–200 kilograms of force during the maneuver, although the force at docking was projected to be only eighty kilograms. The coupler could withstand up to 130 kilograms. The increased force had been partly caused by the failure to stop the motion of the Soyuz after soft-docking. Engineers decided to reinforce the docking system twofold, while introducing the capability of the crew to manually control the pins of the docking system. In the meantime, Mishin proposed that despite the failure of Soyuz 10, plans should now include *two* further missions to the *Salyut* station to complete the original objectives of the program. The first would begin on June 4 and the second on July 18, 1971. Mishin also proposed to have the following crew reduced to two cosmonauts to carry bulky spacesuits that would allow an EVA by one cosmonaut to visually inspect the docking node on the station, as well as to remove the cover for the scientific experiments package. Kamanin categorically rejected this idea, arguing that the cosmonauts had not been trained for EVA and adding that the Zvezda Machine Building Plant.

67. *Ibid.* Nazarov. "You Cannot Paper Space With Rubles."

68. N. Kamanin. "This Should Never Happen Again!" (English title), *Vozdushniy transport* 23 (1993): 12–13; Marinin. "Quarter Century for 'Salyut': Part II "

69. Petrakov, "Soviet Orbital Stations."

which produced the spacesuits, would not be able to certify flight-ready suits by the launch date. In the end, the matter was dropped—a cruel irony considering the later course of events."

At a meeting of the major leaders of the program on May 11, 1971, in Moscow, there was further disagreement between Mishin and Kerimov on one side and Kamanin on the other. The former proposed two missions lasting thirty days each. Kamanin opposed this idea based on his belief that on-board supplies on *Salyut* might be all used up before the end of the second expedition, thus creating a dangerous situation for any crew. In the end, officials decided that the goal of each mission would be to dock with the station and "revive" its systems; any decision on duration would be made during a particular flight. For the benefit of planning, Mishin used information from ballistics computations to tentatively plan for a twenty-five-day flight beginning on June 6, 1971.

There were a number of failures once again in the Igla system during preparations for the next mission, but the State Commission assessed the anomalies and on May 24 certified the Soyuz vehicle (with modifications to the docking system and improved autonomous capabilities) as fully ready for flight. The failure of the Soyuz 10 crew to carry out their primary mission of manning the space station meant that the third crew for the DOS, who would have been consigned to only a backup role during the program, moved up to the second spot. Thus, the crews who were named for the two newly scheduled missions to DOS-1 were: (1) Leonov, Kubasov, and Kolodin and (2) Dobrovolskiy, Volkov, and Patsayev. The latter would also serve as the backup crew to the former. Both crews arrived at Tyura-Tam late on May 28 in preparation for the launch."

All the plans for the mission were thrown into complete uncertainty on June 3 when doctors from the Moscow-based Institute for Biomedical Problems detected a swelling in primary crew flight engineer Kubasov's right lung." Suspecting that this was the beginning of tuberculosis, they unanimously called for his removal from the crew. According to the rules of the Ministry of General Machine Building and the Ministry of Health:

... if one of the members of the crew is taken ill prior to departure to the cosmodrome, he should be replaced by the corresponding member of the other crew. Carrying out the replacement of the individual at the cosmodrome is not possible. In case of such a necessity, it is only possible to carry out the replacement of the [entire] crew."

The verdict was simple but difficult to accept for the crews: the Leonov-Kubasov-Kolodin team would have to be replaced by the Dobrovolskiy-Volkov-Patsayev crew.

Yaroslav Golovanov, then a correspondent for the newspaper *Komsomolskaya pravda* who was at Tyura-Tam at the time, recalled later that "what happened at the Kosmonavt [Hotel, where the crews were staying] is hard to describe." Leonov broke down and visibly lost his temper. Kubasov, who was the center of the controversy, was simply stunned. That night, Kolodin, the third primary crew member, arrived at the hotel completely inebriated on vodka, bemoaning the fact that he may never go to space. Leonov later took the matter directly to his superiors and pleaded that the State Commission only replace the indisposed Kubasov with his backup Volkov, thus making the new crew Leonov, Volkov, and Kolodin. It seems that the

70 Kamanin, "This Should Never Happen Again!," no. 23; Marinin, "Quarter Century for 'Salyut' Part II"; Semenov, ed., *Raketno-Kosmicheskaya Korporatsiya*, p. 188; K. Lantratov, "20 Years From the Flight of 'Soyuz-12'" (English title), *Novosti kosmonautiki* 20 (September 25–October 8, 1993): 39–40.

71. Kamanin, "This Should Never Happen Again!," no. 23; Marinin, "Quarter Century for 'Salyut' Part II."

72 One source suggests that the doctors found "a dark spot on the lungs." See Iosif Davydov, "How Could That Have Been? Slandered Space" (English title), *Rossiyskaya gazeta*, June 11, 1992, p. 5.

73. Marinin, "Quarter Century for 'Salyut': Part II," p. 50. Author's emphasis.

commission was in fact leaning toward this solution despite the ministry's edict. All the cosmonauts, physicians, Cosmonaut Training Center chiefs, and Kamanin himself decided to call for only Kubasov's replacement. Mishin and State Commission Chairman Kerimov tentatively agreed with this recommendation until Mishin had further discussions with participants in Moscow, when he changed his mind and insisted on replacing the entire primary crew. The next day, June 4, two days before the launch, after the Soyuz booster had been transported to the launch pad, a final session of the core members of the State Commission was held. Again, Kamanin recommended replacing only Kubasov. This time, Mishin had the support of most of the other attendees, including Maj. General Nikolay F. Kuznetsov, the Director of the Cosmonaut Training Center. The commission finally decided to replace the entire Leonov crew and launch the Dobrovolskiy crew.⁷⁴ Later that evening, during Mishin's visit to speak to the cosmonauts, Kolodin, in a moment of outrage, "lectured [Mishin] with a lot of extraneous items, which he later much regretted."⁷⁵ According to one report, Kolodin told Mishin that "history would never forgive him" for his decision to send the backup crew.⁷⁶

The original backup crewmembers of forty-three-year-old Lt. Colonel Georgiy T. Dobrovolskiy (commander), thirty-five-year-old civilian Vladislav N. Volkov (flight engineer), and thirty-seven-year-old civilian Viktor I. Patsayev (test engineer) were successfully launched at 0755 hours on June 6, 1971, in their 7K-T spacecraft, vehicle no. 32. The Soviet press announced the mission as *Soyuz 11*. Both Dobrovolskiy and Patsayev were making their first flights, while Volkov was making his second, having flown as part of the "troika" Soyuz mission in late 1969. Most unusually for a space mission, the crew had been formed less than four months before the launch day, having no expectations to fly on such short notice. The Soyuz 11 spaceship entered an initial orbit of 191.5 by 220.5 kilometers at a 51.64-degree inclination. After two orbital changes, the spacecraft was within seven kilometers of the Salyut station. The Igla system was switched on, and successful docking was accomplished at 1045 hours. Ground control at Yevpatoriya in Crimea had to wait a tense half-hour before Dobrovolskiy announced that the docking had successfully taken place. During the fourth orbit of joint operations, pressurization checks proved to be acceptable, and the crew opened the hatch to the station. Patsayev was the first one in the station; the crew immediately turned on the air regeneration system and replaced two of the six faulty ventilation units of the life support system. Unfortunately, the crew sensed a strong odor of burning in the air, which forced them to spend a tense night in their ferry craft. The next day, they returned to the station to discover the odor gone and immediately set about activating instruments on the station in support of their experiments program.⁷⁷

As the days turned into weeks, the three men managed to carry out a remarkably full experiments program despite many attendant problems. By June 9, medical and biological experiments had begun, while experiments in other areas were started on June 11, consisting of spectrographic measurements of natural formations and water surfaces in the Soviet Union. Each day for the crew consisted of eight hours of work, two hours for meals, two hours for exercises, and two hours of personal time. By the sixth day on the station, the men had settled into a rotating routine—that is, when Dobrovolskiy was having breakfast, Volkov would be having supper and Patsayev dinner. Thus two men were always awake while the third one slept."

74 *Ibid.*

75. Cordon R. Hooper. *The Soviet Cosmonaut Team*. Volume 2: *Cosmonaut Biographies* (Lowestoft, UK: GRH Publications, 1990). p. 131

76 Lardier. *L'Astronautique Soviétique*, p. 190.

77 Kamanin, "This Should Never Happen Again!," no. 23; Marinin, "Quarter Century for 'Salyut'. Part II."

78. Lardier, *L'Astronautique Soviétique*. p. 202; Peter Smolders. *Soviets in Space* (New York: Taplinger Publishing Co., 1973). p. 241.

During their mission, the cosmonauts performed about 140 scientific experiments, far more than on any other Soviet space mission. The medical studies included experiments involving the cardiovascular system (using the Polinom-2M), blood tests (*Zmak-3*), the density of bone tissue (Plotnost), pulmonary circulation (Rezeda-S), the measurement of wrist strength, tests of visual acuity, measurements of radiation dosages, and the study of microflora. Strictly biological experiments included those on the growth of plants (using the *Oazis-1* hydroponic greenhouse starting on June 13), the study of the vestibular apparatus of tadpoles, the genetic mutations of flies, the growth of chlorella algae, and the development of grain in microgravity.

Although the crew was unable to use the OST-1 telescope because of the sealed cover, they did manage to conduct an extensive series of astrophysics-related experiments using the Orion-1 ultraviolet and the Anna-3 gamma-ray telescopes. The latter was named after its designer's daughter Anna because "like [her] daughter, gamma-ray astronomy has still a great deal to learn."⁷⁹ Cosmonauts used the Anna-3, capable of registering gamma rays with energy of up to 100 megavolts, for the first time on June 11. The Orion-1 telescope, built by the Armenian Academy of Sciences, was used on June 18 and 21 to make six and nine ultraviolet spectrograms of celestial targets, such as Beta (Centaurus) and Vega (Alpha-Lyra). The study of charged particle flux was accomplished with a third telescope named the TEB. The cosmonauts also used the FEK-7 emulsion chamber to register primary cosmic rays for over a period of 1.728 hours. One inert instrument was the MMK-1, which measured micrometeoroid flux on the exterior of the station.



The primary crew of *Soyuz 11* is shown at the top of the service mast prior to entering their spacecraft. From left are Georgiy Dobrovolskiy (commander), Viktor Potsoyev (test engineer), and Vladislav Volkov (flight engineer). (NASA photo)

⁷⁹ Smolders *Soviets in Space* p. 245. The scientist in question was A. M. Galper. The Anna-3 was developed by the Moscow Institute of Engineering and Physics under the supervision of V. G. Kirillov-Ugryumov.

Other experimental disciplines included studying the geophysical properties of Earth with various cameras, such as the AFA-M, the KFA-21, and the handheld RSS-2 spectrograph, which was developed by the Department of Atmospheric Physics at Leningrad State University. Researchers used the same spectrograph from An-2 and Il-18 aircraft at altitudes of 300 and 8,000 meters simultaneously with the cosmonauts to determine pollution and precipitation levels in the Caspian Sea. The crew also used the RSS-2 on June 14 and 15 to determine humidity of the soil in areas around the Caspian and Aral Seas. On June 11, 19, and 22, they used the spectrograph to measure the optical characteristics of Earth's atmosphere and the degree of polarization of sunlight reflected by Earth. The crew also measured the chemical composition of the atmosphere with a mass spectrometer and used the ERA instrument for studying atmospheric resonance in the ionosphere. Earth observation research included coordinated studies with a Meteor-1 satellite over several days using two hand-operated devices on the station. Strictly technological experiments were related to the station itself. The crew observed luminous particles outside the station with a photometer, and also they studied the dynamic characteristics of the station with a stellar camera."

Throughout the mission, reports from the cosmonauts in Salyut were shown on Soviet television. Many of their exchanges on TV were humorous in nature, contrasting sharply with the morose image of the Soviet spacefarer, and it was clear that the three men were having the time of their lives. By mid-June, the three men had become household names in the Soviet Union—a new breed of folk hero for a country whose prestige had been trampled by the success of Apollo. For the first time in many years, the Soviet human space program could claim a genuine advance and victory over the United States. It would not be an overstatement to claim that much of the general population anticipated the return of the three cosmonauts in a unified way that had not been witnessed for many years.

The continuing TV reports did not, of course, tell the whole story behind the mission. There were, in fact, many problems for the crew aboard the station—problems that on occasion hindered productive work. For example, during the first two weeks of the mission, there were a number of personality clashes between the members of the crew, which were mediated by cosmonauts on the ground at Yevpatoriya who served as "capcoms."⁸¹ Although these difficulties were resolved, a more serious emergency occurred on June 16, when flight engineer Volkov suddenly radioed to capcom Shatalov that he sensed a strong odor of smoke. Assuming the worst-case scenario of a fire in the station, cosmonauts Nikolayev and Yeliseyev on the ground ordered the crew to immediately evacuate to their Soyuz ferry craft and begin preparations for undocking. Having quickly moved into the Soyuz, the crew first began attempts to establish the cause of the emergency by switching on the backup electrical supply system on Salyut and turning on filters to purify the atmosphere. Following a tense period, during which instruments tested the atmosphere in the station for safety, the cosmonauts entered the Salyut station once again.⁸²

The drama seemed to have intensified the discord brewing among the crew. Veteran cosmonaut Bykovskiy, at Yevpatoriya, recalled that during the emergency, Volkov had become extremely nervous and had tried to resolve the situation by himself, ignoring the assistance of

80. Lardier. *L'Astronautique Soviétique*, pp 202-03; Bert Dubbelaar. *The Salyut Project* (Moscow: Progress Publishers, 1986), pp 12-16.

81. The cosmonauts involved in ground control were V F Bykovskiy, V V. Corbatko, A. C. Nikolayev, V. A. Shatalov, and A. S. Yeliseyev.

82. Kamanin. "This Should Never Happen Again!," no. 23. I. Marinin, "Quarter Century for 'Salyut': Part III" (English title), *Novosti kosmonautiki* 12-13 (June 3-30, 1996): 77-81.

his crewmates Dobrovolskiy and Patsayev. In an unusual move, Chief Designer Mishin communicated personally with Volkov, informing him that all operational decisions should be taken by the commander (Dobrovolskiy) and that mission-critical operations should be carried out only at his discretion. Volkov irritably responded that the entire crew was aggravated and that all decisions should be made collectively. In an amplification of the event, Mishin recalled in a 1989 interview that a personality clash had developed between Dobrovolskiy and Volkov, during which Volkov, the only spaceflight veteran on board, declared himself the commander of the mission, usurping Dobrovolskiy's role. There were apparently several "complicated conversations" between Mishin and Volkov after the incident." In Kamanin's opinion, Volkov had acted hastily and had a disdainful attitude to those at ground control. Mishin also added that there may have indeed been a fire on the station originating from a power cable, and the crew apparently asked for permission to return to Earth immediately but were dissuaded by ground control.⁸⁴ The entire situation was diffused following extensive consultations with cosmonauts on the ground, who were able to bring the crew back to their experiments program.

The Soyuz 11 crew was scheduled to observe the third NI lunar rocket during its launch on June 20 from Tyura-Tam using the *Svinets* instrument designed for military purposes. The launch was, however, moved to June 22 and eventually to June 27, and the crew's ground track was not over the launch site at the time of the NI launch. Dobrovolskiy was able to skillfully use *Svinets* on June 24 and 25 to observe night launches of solid-propellant ballistic missiles from Tyura-Tam.⁸⁵

The cosmonauts' medical program was not completely successful. The cosmonauts were apparently reluctant to exercise, and the problem was compounded by several failures on the station. Kamanin wrote in his diary on June 23 that:

*... the readaptation will be particularly difficult for Volkov: during the flight he has been more reluctant to do physical exercises than the other crew members, he has totally rejected meat food, he has often been irritated and has already been making a lot of mistakes.*⁸⁶

The running track was rarely used because of unexpected vibrations when exercising, which shook the solar panels and communications antennas. The *Chibis* vacuum suit used for shifting blood to the upper regions of the body was the source of many problems and was rarely used. The load-bearing *Pingvin* space suits also tore at various places during exercises, neutralizing their impact. Naturally, the lack of calisthenics was a great concern to doctors on the ground, who believed that the crew would be in extremely poor shape after a near-month-long mission. Given the problems on the mission, Mishin backed away from his insistence on a thirty-day mission, instead opting for a more conservative flight of twenty-two to twenty-four days. On June 22, the State Commission confirmed the decision to land the crew on June 30, on that day's third orbit, early in the morning.

The three cosmonauts began preparations to return to Earth on June 26. They had exceeded the world-record endurance for a single piloted spaceflight two days earlier on their eighteenth day in space. Despite increasing numbers of mistakes on the part of the crew, attributed to fatigue, the crew completed all their return procedures on time, and on the evening of June 29, they transferred to the Soyuz 11 spaceship and closed the hatch between the two space-

83. Tarasov. "Missions in Dreams and Reality."

84. *Ibid*

85. Nikolay Kamanin, "This Should Never Happen Again!" (English title), *Vozdushnyi transport* 24 (1993): 12; Marinin, "Quarter Century for 'Salyut': Part III." The cosmonauts also used the OD-4 optical "visor-range finder" to perform military observations of ground targets.

86. Kamanin, "This Should Never Happen Again!," no. 24, p. 12.

craft. The crew then moved into the descent apparatus and shut the hatch between it and the spherical living compartment. There was a major crisis at this point when the "Hatch Open" indicator light between the Soyuz living compartment and the descent apparatus failed to turn off. Fatigued and anxious, Volkov excitedly called out to ground control: "The hatch isn't pressurized, what should we do, what should we do?!!" Cosmonaut Yeliseyev, who was the capcom at the time, calmed Volkov down and gave the crew detailed instructions to go through the entire hatch-closing procedure once more. Dobrovolskiy and Patsayev expertly followed the instructions, but the indicator light remained turned on. All the members of the crew grew increasingly nervous because in a few minutes that hatch would be the last barrier between the crew and open space.

After intensive discussions, the Chief Operations and Control Group on the ground recommended placing a piece of paper over the sensor that detected hatch closing, presumably in the belief that it was a sensor error. Dobrovolskiy found a piece of plaster, which he placed over the sensor, and shut the hatch once more. This time the indicator turned off, and all subsequent pressurization checks proved satisfactory. The twenty-minute crisis with the hatch had strained the nerves of the crew, but following the tests, the cosmonauts apparently calmed down and proceeded with preparations to undock from the station. At 2125 hours, 15 seconds, the Soyuz 11 spaceship undocked from *Salyut* and flew around the station, and Patsayev took a number of photographs. At around 0135 hours on June 30, Volkov reported that the "'Return' indicator light is on." Ground control replied, "Let it be on. It's correctly on. Communications are ending. Good luck!" After that, communications were cut off as the Soyuz drifted out of voice contact, and they were evidently never regained. According to the preprogrammed sequence of reentry, the main Soyuz engine was to begin firing at 0135 hours, 24 seconds Moscow Time on June 30, followed by separation of the three Soyuz modules at 0147 hours, 28 seconds. Ground control was, however, unsure whether this had indeed taken place because of the loss of communications. Search-and-rescue services proceeded on the assumption that all was going according to plan on the Soyuz 11 ship, and the teams from the Soviet Air Defense Force and Air Force detected the descent apparatus of the spacecraft on time in the assigned location. The capsule landed at 0218 hours Moscow Time about 202 kilometers east of Dzhezkazgan in Kazakhstan. The mission had lasted twenty-three days, eighteen hours, twenty-one minutes, and forty-three seconds. As soon as rescue teams opened the vehicle hatch, they found the crew lifeless in their seats.

The recovery teams attempted to revive the cosmonauts after bringing them out of the capsule, but it was all in vain. In the meantime, the State Commission at Yevpatoriya received a message back from the rescue services concerning the deaths. Immediately, Afanasyev, Kerimov, Mishin, Kamanin, DOS lead designer Semenov, and others flew directly to the landing site. Other officials, including doctors, also flew in from Moscow. An on-the-spot investigation indicated that there was blood in the crew's lungs, nitrogen in their blood, and hemorrhages in their brains, which were all obvious indicators of death by depressurization. An inspection of the ship's interior showed that all the radio transmitters had been manually turned off, the shoulder straps of all the cosmonauts were unfastened, and Dobrovolskiy himself had been tangled in his straps. Everything in the Soyuz 11 descent apparatus appeared normal, everything except one of two valves in the respiratory system, which was in an open position, strongly supporting the hypothesis that there had been a rapid decompression.⁸⁹

87 Marinin, "Quarter Century for 'Salyut': Part III"; N. Kamanin, "This Should Never Happen Again" (English title), *Vozdushniy transport* 25 (1993): 12.

88 O. Ye. Leonov, "Until We Meet on Earth" (English title), *Otechestvennyy arkhiv* 3 (1994): 71-80.

89 Semenov, ed., *Raketno-Kosmicheskaya Korporatsiya*, p. 188; Marinin, "Quarter Century for 'Salyut': Part III."

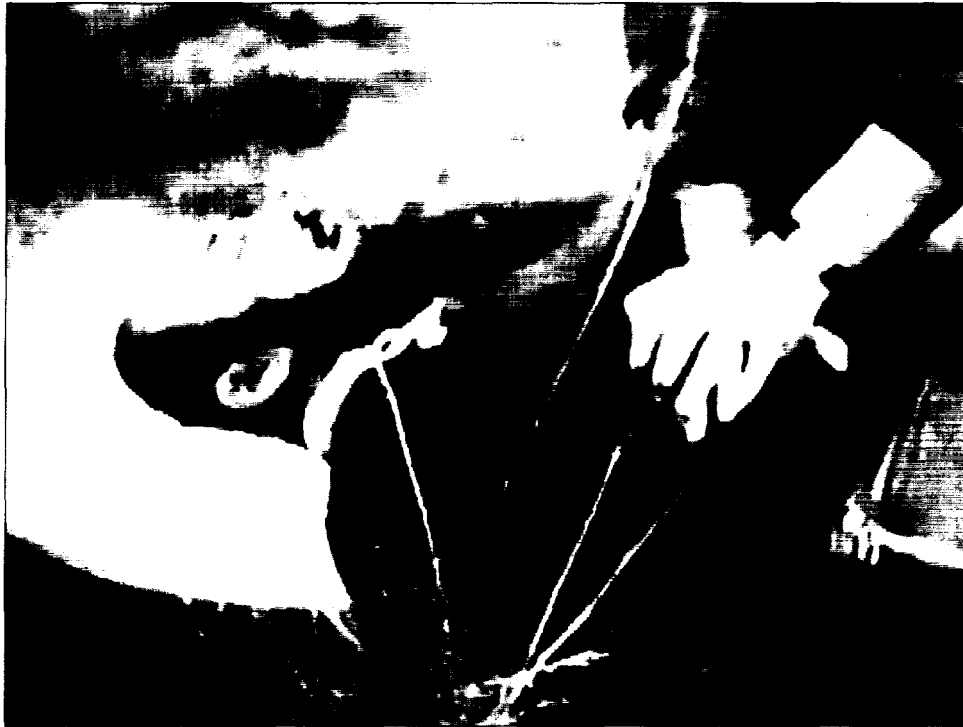

Cosmonaut Georgiy Dobrovolskiy Soyuz 11 commander, is shown here just minutes after death as medical workers try to revive him. The beard was from approximately twenty four days spent on the Salyut space station in June 1971. At the time this was the longest piloted space mission in history. (copyright Rudy Inc via Quest)

The shock not only to the space industry but also the Soviet Union as a whole was devastating. An unprecedented wave of grief swept through the country, not unlike the collective mourning in the United States after President Kennedy's assassination in 1963. Official Soviet TV and radio changed their formats to accommodate for the tragedy, while countless condolence messages poured in from leaders all over the world. Apart from the human loss itself, the Soyuz 11 tragedy was a severe blow to the Soviet space program, coming at a time when it had been so close to reclaiming the lost glory of the Korolev years. In a cruel twist of fate, the Soviet space program was not even accorded a consolation prize in the space race. It was beset with problems far more imposing than simply political cost. If 1969 was the year of humiliation for the Soviet space program, 1971 was its nadir—an absolute low unthinkable a few years before.

The bodies of the three cosmonauts were flown back to Moscow only a few hours after landing, and the following day, on July 1, they were already lying in state in Moscow. Thousands of Soviet citizens flocked to pay their last respects. Unlike the Komarov funeral, when no NASA representative was present, veteran astronaut Brig. General Thomas P. Stafford was on hand, representing the NASA Astronaut Office. Behind the scenes, on July 3, 1971, Ustinov established a governmental State Commission to investigate the accident and recommend changes in the DOS-7K program. As one would expect, Academician Keldysh headed the commission. Chief Designer Babakin from the Lavochkin Design Bureau was the deputy chair.

CHALLENGE TO APOLLO

The remaining members included Chief Designer Clushko and Minister Afanasyev.⁹⁰ On July 12, the commission issued a preliminary report, which gave general details of the accident to the general public for the first time:

During the descent of the spaceship. 30 minutes before landing, pressure in the return capsule dropped rapidly, which led to the unexpected death of the cosmonauts. This has been confirmed by medical and pathological-anatomical examinations. The drop in the pressure was the result of failure of the hermetic sealing of the spaceship. . . . Technical analysis indicates that there are several possible explanations of the de-sealing. Investigation into the exact cause continues."

The following day, the commission met and agreed that the most probable cause of the accident was depressurization resulting from the premature opening of the second respiratory valve in the descent apparatus. Already, two senior members of TsKBEM's staff, Bushuyev and Korzhenevskiy, were recommending that future Soyuz crews be brought down to two cosmonauts with full spacesuits.

Through the following weeks, an analysis of the *Mir* on-board memory device showed that at the moment of separation of the living compartment from the descent apparatus, at an altitude of more than 150 kilometers, the pressure in the descent apparatus dropped in the course of thirty to forty seconds to a near vacuum. The rate of the pressure drop corresponded to the respiratory system's valve opening. The conclusion was obvious: at the moment of separation of the two modules, the valve had prematurely opened. More difficult was determining exactly why it had been jarred open. Engineers carried out dozens of experiments simulating various loads on the suspect valve, but no one particular cause stood out. Only when all types of deviations from normal parameters were introduced *simultaneously* did the valve fail." Based on the Keldysh commission's analysis of voice tapes and telemetry, as well as Kamanin's own diary entries, it was, however, possible to reconstruct the sequence of events that led to the tragedy.

It seems that the reentry burn was on time and completely successful. Subsequently, at the very moment that the Soyuz spacecraft separated into its three component modules, also on time, twelve explosive bolts used for separation produced an overload, displacing a ball joint from its seating.⁹¹ This accidentally jerked open the ventilation valve, which was to have opened only *after* landing; suddenly, there was a direct passage from the crew compartment to the vacuum outside. The crew immediately noticed the drop in pressure inside the capsule; Dobrovolskiy quickly unfastened his seat belts and rushed to the frontal hatch, thinking that the problem was the faulty hatch seal from the undocking incident. The hatch was completely secure, yet the pressure continued to drop in a whistle that continued to get louder. In fact, the sound of the air whistling out of the spacecraft was coming not only from

90 Semenov, ed., *Raketno-Kosmicheskaya Korporatsiya*. p. 188. The remaining members of the commission were: A. I. Burnazyan (Ministry of Health), S. G. Frolov (WS), P. D. Grushin (MKB Fakel), V. A. Kazakov (MAP), M. N. Mishuk (WS), V. A. Shatalov (WS), V. I. Shcheulov (TsUKOS), and A. I. Tsarev (VPK).

91 Smolders, *Soviets in Space*. p. 248. One report suggests that the early hypothesis of the doctors on the ground was that the cosmonauts died because of the effects of gravity after such a relatively long period of weightlessness. Dr. Portugalov, the chief of the Morphology Department at the Institute for Biomedical Problems of the Ministry of Health, however came to the conclusion that it had been a valve failure resulting in depressurization. The same conclusion was also reached by anatomists at the Kirov Academy. See Mozzhonn, *et al.*, eds., *Dorogi v kosmos*: I. p. 64.

92. Semenov, ed., *Raketno-Kosmicheskaya Korporatsiya*. pp. 188-89

93. Tarasov, "Missions in Dreams and Reality"

the suspect valve, but also from on-board radio transmitters and receivers, making it difficult to isolate the true source. At this point, Volkov and Patsayev unfastened their belts and switched off all communications systems to find the source of the whistling; the sound was apparently coming from a point under Dobrovolskiy's seat—the ventilation valve. Dobrovolskiy and Patsayev attempted to manually close the valve, but the time was just too short.⁹⁴ Both fell back in their seats, with Dobrovolskiy having time to refasten his belts in a hurried move, which left them tangled.

The speed of the pressure loss in the capsule was incredibly swift. Just four seconds after the ventilation valve failure, Dobrovolskiy's breath rate shot up from sixteen (normal) to forty-eight per minute. After the beginning of pressure loss, the cosmonauts lost the capacity to work in ten to fifteen seconds and were dead in forty-eight to forty-nine seconds. They were apparently "in agony" three to five seconds after separation until about twenty to thirty seconds before death. All the pressure in the capsule dropped from a normal level of 920 millimeters to zero in a matter of 112 seconds." As one Russian journalist later put it, the cosmonauts "passed away fully aware of the tragic consequences of what had happened."⁹⁵ Both Kamanin and Mishin seemed to believe that the crew could have prevented their deaths by simply blocking the suspect "hole." In an interview in 1990, Mishin added: "They could hear the hiss of escaping air. They could have put a finger over the hole and that would have done it."⁹⁶ Some believed that the crew had not been properly trained in the operation of the valve, which was to be operated only *after* Soyuz landing. The technical documentation on the valve stipulated: "If in case of a water landing, the hatch does not open due to rough seas, or rescue teams are late in coming for over an hour, the cosmonauts may open the valve."⁹⁷

The reason why the seal failed is still unknown, although an article in *The Washington Post* in 1973 by Thomas O'Toole provided some interesting clues. O'Toole's description, based on a "classified report," was the first and only Western report to accurately describe the hatch-closing emergency prior to reentry in great detail. The author added: "[When] the exhausted cosmonauts were fighting the warning light on the hatch they apparently failed to notice that the cabin pressure had crept up to almost 20 pounds per square inch. What this did was to exaggerate any weakness in the hatch seal."⁹⁸ O'Toole's report was apparently culled from a classified CIA brief issued the day after the accident, in which the CIA detailed the undocking and reentry problems at the end of the mission.⁹⁹

94 Mishin says that it was only Patsayev who attempted to close the valve. See G. Salakhutdinov, "Once More About Space" (English title), *Ogonek* 34 (August 18-25, 1990): 4-5.

95 Kamanin, "This Should Never Happen Again," no. 25; Marinin, "Quarter Century for 'Salyut' Part III."

96 Mikhail Rebrov, "With a One-Way Ticket" (English title), *Krasnaya zvezda*, September 26, 1996, p. 4. A somewhat different explanation was given to NASA officials in October 1973. "At approximately 723 seconds after retrofire, the 12 Soyuz pyrocartridges fired simultaneously instead of sequentially to separate the two modules. The force of the discharge caused the internal mechanism of the pressure equalization valve to release a seal that was usually discarded pyrotechnically much later to adjust the cabin pressure automatically. When the valve opened at a height of 168 kilometers, the gradual but steady loss of pressure was fatal to the crew within about 20 seconds." See Edward Clinton Ezell and Linda Neuman Ezell, *The Partnership A History of the Apollo-Soyuz Test Project* (Washington, DC: NASA SP-4209, 1978), p. 230.

97 "The Russian Right Stuff: The Dark Side of the Moon," NOVA television show, #1808, WGBH-TV, Boston, February 27, 1991; Tarasov, "Missions in Dreams and Reality," The valve was apparently a millimeter across. See Payson, "Without the 'Secret' Stamp."

98 Kamanin, "This Should Never Happen Again!," no. 24.

99 Thomas O'Toole, "Soviet Union Still Trails U.S. in Space," *Washington Post*, June 17, 1973, pp. A1, A8.

100 U.S. Central Intelligence Agency, "National Intelligence Estimate 11-1-71: The Soviet Space Program," Washington, DC, July 1, 1971, pp. 30-32, as declassified in 1997 by the CIA Historical Review Program.

The members of the Keldysh commission signed the final version of the accident investigation on August 17, 1971, about a month and a half after the accident.¹⁰¹ The commission collectively made some specific recommendations: increase the stability of the valve with respect to shock loads, install quick-acting (within seconds) manual chokes for valves, and use spacesuits during conditions when depressurization was possible.¹⁰² The final point, the use of spacesuits, was evidently a much-debated issue, with individuals such as Mishin and Feoktistov arguing against it. Mishin summarized his opinion on the matter twenty years later when he wrote:

In principle, all the recommendations of the commission were correct, but with one I do not agree to this day—the introduction of the spacesuit which Korolev had abolished from the "Voskhod" spaceship. . . . In multi-seat spaceships it is necessary to ensure collective safety, which can be better ensured by duplicating the systems that pressurize the entire Descent Apparatus. . . . The spacesuits required additional complex devices, thus increasing weights and volumes. The commissions recommendations to introduce spacesuits . . . made it necessary to reduce the crew of the spaceship to two and [to reduce] the conduct of special experiments.¹⁰³

Unfortunately for Mishin, one of those pushing the use of spacesuits was Central Committee Secretary Ustinov. When Mishin and his Deputy Chief Designer Bushuyev met with Ustinov on August 6, Ustinov was firm on the issue: it was impossible for any more Soviet crews to fly in space without pressurized spacesuits. The Zvezda Machine Building Plant under Chief Designer Cay I. Severin was asked to accelerate its current efforts to prepare a new suit, named the *Sokol-K*, specifically for the Soyuz spacecraft. At the same time, two different departments at Mishin's design bureau began the process of redesigning the 7K-T Soyuz spacecraft to meet the recommendations of the Keldysh commission.¹⁰⁴ Later, the Ministry of General Machine Building handed out special reprimands for the disaster to six leading personalities, including Mishin, Bushuyev, and Tregub.¹⁰⁵

As far as future missions to the *Salyut* station, they were out of the question at that point. During the flight of Soyuz 11, the State Commission had met to set the launch date of the second expedition to the station for July 20. This crew, composed of Leonov, Rukavishnikov, and Kolodin, along with their backup crews, began joint training on June 16. Training for all the crews was terminated on July 9, 1971, nine days after the Soyuz 11 tragedy. The immediate goal was to make changes to the Soyuz spacecraft and introduce mandatory spacesuits for all the crewmembers. Because the introduction of spacesuits would take additional volume and mass, TskBEM reluctantly decided to truncate further crewmembers from three to two, eliminating the test engineer position. The *Salyut* station, meanwhile, continued to circle Earth. Ground controllers fired its main engines at least five times to prevent orbital decay over the course of three months. Finally, on October 11, its supplies already expired in August, the station was commanded to reenter Earth's atmosphere over the Pacific Ocean.

Among the many stranger-than-fiction ironies of this first space station project, clearly one of most chilling was the last-minute replacement of the Soyuz 11 primary crew. In an interview

101. The signatories were M. V. Keldysh (President, Academy of Sciences), L. V. Smirnov (Chairman, VPK), S. A. Afanasyev (Minister, MOM), I. D. Serbin (Chief, TsK KPSS Defense Industries Department), V. A. Kazakov (Deputy Minister, MAP), M. N. Mishuk (WS), P. D. Grushin (General Designer, MKB Fakel), A. I. Tsarev (Deputy Chairman, VPK), and V. P. Mishin (Chief Designer, TskBEM)

102. Semenov, ed., *Raketno-Kosmicheskaya Korporatsiya*, pp. 188–89.

103. Mozzhorin, et al., eds., *Dorogi v kosmos*, I, p. 124. See also Tarasov, "Missions in Dreams and Reality"

104. Semenov, ed., *Raketno-Kosmicheskaya Korporatsiya*, pp. 188–89.

105. The reprimands were stipulated in a ministry resolution (no. 259ss) on August 19, 1971.

in June 1988, one of those replaced, Petr I. Kolodin, confided that the deaths of Dobrovolskiy, Volkov, and Patsayev still played on his conscience: "I was to fly, and Dobrovolski and his colleagues were to have remained on Earth. They were killed and I'm alive."¹⁰⁶ Although he was scheduled to fly a Soyuz mission in 1978, Kolodin did not, in fact, ever join the ranks of "true" cosmonauts. Leonov and Kubasov, the two remaining members of the crew, were recycled back into training for future DOS missions. Kubasov's lung problem, which had effectively saved his life—and those of Leonov and Kolodin, too—later turned out to be only an allergic reaction.¹⁰⁷

Military Space

At the time of the Soyuz 11 disaster, the Soviet space program was almost fifteen years old. Forged out of the innards of the Soviet military-industrial complex, the space effort, by and large, remained hostage to the whims of military requirements and the opinions of those leaders who were responsible for building and maintaining the defense might of the Soviet Union. Typically, the triumvirate of individuals responsible for the defense industry—Ustinov, Smirnov, and Afanasyev—were ultimately accountable for dictating the direction of the space program. However, the needs of the Ministry of Defense—the primary clientele for all space products—also played a major role in the formation of long-range state policy. In March 1967, Marshal Andrey A. Grechko, a former Commander-in-Chief of Soviet Ground Forces, became the new USSR Minister of Defense. Subordinate to Grechko were all the heads of the armed services, including Marshal Nikolay I. Krylov, the Commander-in-Chief of the Strategic Missile Forces. Both were extremely influential in defining the long-term goals of the Soviet space program—the Five-Year Space Plans.¹⁰⁸ The fact that both were regarded as virulently against "big funding" for the piloted space effort was a major factor in the military's lack of interest in an active human space program. Air Force Col. General Karnanin, one of the few high-ranked men within the military supportive of strong piloted operations in space, lamented in June 1970:

Grechko has still not been at the [Cosmonaut Training Center] although he promised three times to visit it. I do not know if he will keep his word this time, but his possible trip to us does not make me very happy; the minister obviously underrates the importance of the space program for the country's science, economy and defense. However we are totally dependent on Marshal Grechko and it would be foolish not to attempt to "relate" to him with space.¹⁰⁹

The effects were repercussive: because all space products, whether they were Soyuz ships or space stations, were ultimately built for and operated by the Strategic Missile Forces, most of the major chief designers, such as Mishin, Glushko, Chelomey, and Yangel, had to pander to Grechko and Krylov for their blessing.

The Strategic Missile Forces remained in tight control over all operational activity in the Soviet space program. Its subordinate Central Directorate of Space Assets, headed by Lt. General Andrey G. Karas, had inherited this job from the old artillery days. The other armed

106 Hooper *The Soviet Cosmonaut Team* Volume 2, p. 132

107 Davydov "How Could That Have Been?"

108 There are few published details of these Five Year Space Plans. One account—of a meeting between MOM Minister S. A. Afanasyev and USSR First Deputy Minister of Defense M. V. Zakharov in August 1969—clearly indicates the influence of the Ministry of Defense over the content of these plans. See Mozzhorin *et al.* eds. *Dorogi v kosmos* 1, pp. 218–19.

109 L. N. Kamanin "Removing the Cosmetic Retouching: N. Kamanin—From His Journal Entries for 1970" (English title) *Souetskaya kultura* July 14, 1990, p. 15.

services—the Air Defense Forces, the Air Force, and the Navy—were naturally hostile to this monopoly, and in 1970, a detailed plan was drawn up to have this directorate subordinated directly to the Ministry of Defense, thus circumventing the stranglehold by the Strategic Missile Forces over space operations. Even Marshal Krylov initially supported the idea, but at the last moment, senior Strategic Missile Forces officers opposed the idea. Karas stalled the plan by suggesting that his directorate remain under the Strategic Missile Forces for two to three more years, to allow a more detailed look at the issue. In March 1970, the directorate was reorganized into the Chief Directorate of Space Assets (GUKOS), but it still remained an operational arm of the Strategic Missile Forces, carrying out launch, command, and control over every single Soviet spacecraft launched into orbit. The "two to three years" that Karas had proposed eventually stretched into nearly twelve years. It was only on November 10, 1981, that GUKOS was removed from Strategic Missile Forces jurisdiction.¹¹⁰ The successor to GUKOS eventually became the Russian Military Space Forces—in the 1990s.

Influencing the direction of the Soviet space program was not just a matter of power but also patronage. Minister of Defense Crechko was a strong supporter of Minister of General Machine Building Afanasyev, who in turn helped prop up many of Chelomey's tenuous programs, such as the Almaz space station. On the other side, Central Committee Secretary Ustinov, a well-known anti-Chelomey partisan, was on the side of Chief Designers Yangel and Mishin. This peculiar bicameral noninstitutional factionalism helped sustain tension between the Mishin and Chelomey factions for many years. In terms of the ICBM program, the Grechko-Ustinov enmity resulted in a severely acrimonious battle—a "civil war" between Chelomey and Yangel over the development of a third generation of strategic missiles. Unable to make the decision between a Chelomey proposal and a Yangel proposal, Soviet leader Brezhnev succumbed to pressure on both sides by approving the development of two concurrent ICBMs with almost identical capabilities, thus squandering billions of rubles."

The negative attitude of the military toward piloted space projects meant that a number of important programs suffered during the late 1960s and early 1970s. One program that fell under Crechko's vendetta against space was the Spiral piloted spaceplane program. By 1967, engineers at the "space branch" of the Mikoyan design bureau (MMZ Zenit) gave out subcontracts to build testbeds for Spiral. The first such testbed was an 800-kilogram, three-meter-long scale model of Spiral's Experimental Piloted Orbital Aircraft (EPOS), named BOR-I. It was designed and built by two major research institutions, the N. Ye. Zhukovskiy Central Aerohydrodynamics Institute (TsAGI) and the M. M. Gromov Flight-Research Institute. Manufacturing was carried out at Plant No. 166 at Omsk. The creation of BOR-I was part of a larger research program in support of Spiral to investigate aerodynamics, thermal protection, the prospects of using hypersonic scramjets, and the rescue of the object after its return from space. The program would include studying atmospheric return from altitudes of 200 to ten kilometers and velocities of 7,500 down to 250 meters per second—that is, about Mach 27.5 down to Mach 0.8. The initial suborbital flights of BOR vehicles would last about three minutes; these would lead to "orbital" missions lasting fifteen to twenty minutes.

110. Mozzhorin, et al., eds., *Dorogi v kosmos: I*, pp. 221–22; I. D. Sergeyev, ed., *Khronika osnovnykh sobytiy istorii raketnykh voysk strategicheskogo naznacheniya* (Moscow: TsIPK, 1994), p. 17.

111. Brezhnev's final decision led to the development of Chelomey's UR-100N missile (approved by the Soviet government on August 19, 1970) and Yangel's MR UR-100 missile (approved by MOM in September 1970). For a discussion of the "civil war," see Mozzhorin, et al., eds., *Dorogi v kosmos. I*, pp. 149–50; Roald Z. Sagdeev, *The Making of a Soviet Scientist: My Adventures in Nuclear Fusion and Space From Stalin to Star Wars* (New York: John Wiley & Sons, 1993), pp. 205–06; B. Ye. Chertok, *Rakety i lyudi: goryachiye dni kholodnoy uoyny* (Moscow: Mashinostroyeniye, 1997), 68–70; Vladimir Cubarev, "Southern Launch" (English title), *Nauka i zhizn* no. 10 (October 1997): 36–45.



This flown model of the BOR 2 lifting body was recently on display at a Russian exhibition. Note the damage from thermal loads during reentry on the bottom face of the vehicle. The insignia of the Gromov Flight Research Institute is visible near the nose of the spacecraft. This vehicle was launched sometime between 1969 and 1974 on a suborbital mission. (copyright Steven Zaloga)

BOR-1 was specifically designed to separate from a conventional ballistic launch vehicle at an altitude of 100 kilometers and a velocity of 3.7 kilometers per second and then complete a gliding flight into the atmosphere. Within two years, engineers were able to develop adequate thermal shielding for the vehicle, which would potentially face angles of attack at up to forty-five degrees upon entry into the atmosphere and endure temperatures as high as 1,500–1,600 degrees Centigrade. After intensive ground trials, the first and only BOR-1 spaceplane was launched on July 15, 1969, on an R-12 missile, just six days before the Apollo 11 landing. One Russian historian later summarized the outcome:

Test results showed that the "lifting body" was marvelously balanced even at angles of attack exceeding 60°. And although the first model was made of wood and was equipped with the gear of a six-weight mock-up, it was the model from which scientific results were obtained, before its burnup at altitudes of 60–70 kilometers.'

Efforts in other fronts in the Spiral program also continued at the time. A twenty-kilometer-long landing strip was in the process of construction. Engineers had also evidently built a subsonic model of the spaceplane equipped with instrumentation transferred from the Tu-95 bomber. Unconfirmed rumors suggest that at least three drop flights were performed during this

112. V. Ageyev. "Unknown Pages of Space Science: In Flight —The 'BOR'" (English title). *Aviatsiya i kosmonavtika* no. 1 (January 1992), 42–43. E-mail correspondence, Igor Afanasyev to the author. December 11, 1997.

CHALLENGE TO APOLLO

period from altitudes of 9,000 meters, which "fully confirmed the design characteristics of the Spiral airplane."¹¹³ At the same time, MMZ Zenit, under its BOR program, emerged with plans for two new subscale lifting bodies. BOR-2 and BOR-3. Again, the purpose of the work was to carry out research on aerodynamic characteristics, heat exchange, and thermal shielding of the Spiral design at hypersonic velocities. The data gathering was limited to altitudes of ten to 100 kilometers, speeds of Mach 5 to 13.5, and angles of attack of fifteen to sixty-five degrees. Another variant, the BOR-4 model, which was designed on the basis of BOR-2, would be the basic "working horse" of the BOR program and use new heat-shielding material.¹¹⁴

TsAGI also carried out a huge amount of research on the carrier aircraft for Spiral, the so-called Hypersonic Booster-Aircraft (GSR), which would accelerate the actual spaceplane to speeds of Mach 4-6 during operational missions. Scientists studied two variants of the carrier, GSR-1 and GSR-2, both of which went through a full cycle of testing in wind tunnels at the institute. A large part of this work, performed between 1965 and 1975, was research focused on methods of testing models with air ducts over the "gondola" propulsion units during flight at hypersonic velocities.¹¹⁵

Trouble struck the Spiral program in 1969. By this time, engineers needed a formal decree of the Central Committee and the Council of Ministers to continue serious work. Unfortunately for Spiral Chief Designer Lozino-Lozinskiy, this is where Minister Grechko stepped in. Although the appropriate ministers and Communist Party leaders, in 1969, evidently signed the project order, Grechko scrawled on the document "This is a fantasy."¹¹⁶ Lozino-Lozinskiy, perhaps being generous to Grechko, recalled later that "the Soviet leadership felt it would take too much time and money to bring the program all the way to completion."¹¹⁷ A variety of other problems, all related to money, seems to have slowed down the project. Despite the considerable theoretical work on the CSR, the creation of flight models required a huge financial commitment, which was unavailable. By the early 1970s, scientists were also coming to the opinion that an air-launched reusable spaceplane system might not be the best route to take; a vertical missile-launched system might offer a much cheaper and efficient alternative. Research on liquid hydrogen engines for the carrier aircraft also stalled sometime in 1967 or 1968, apparently because the Soviet government was "biased" against this work, carried out by Struminskiy and Lyulka, at the Institute of Theoretical and Applied Mechanics at Novosibirsk, which was under the Academy of Sciences.¹¹⁸

Despite Grechko's prohibition on Spiral work, MMZ Zenit's space branch continued low-level work "semi-legally" on the Spiral project. The scope of the post-1969 work was, in fact, quite remarkable, and one wonders how Lozino-Lozinskiy managed to sustain it. Between 1969 and 1974, the Gromov Flight-Research Institute and TsAGI launched seven BOR-2 and BOR-3 subscale spaceplanes using the R-12 missile on suborbital and/or vertical launches to

113. Cleb E. Lozino-Lozinskiy and Vladimir E. Plokhikh. "Reusable Space Systems and International Cooperation." *Aerospace America* (June 1990): 37-40; G. Titov. ". . . This Is Needed for All of Us" (English title). *Aviatsiya i kosmonavtika* no. 4 (April 1993): 2-3. Unconfirmed Western sources also suggest that there may have been drop tests of the spaceplane in the late 1960s. See, for example, Peter N. James. *Soviet Conquest From Space* (New Rochelle, NY: Arlington House Publishers, 1974), p. 129. Note that these drop tests, if they did occur, were different from subsequent tests in 1976-78.

114. Afanasyev correspondence, December 11, 1997.

115. TsAGI. *Osnovnyye etapy nauchnoy deyatel'nosti, 1968-1993* (Moscow: Nauka, 1996), p. 156.

116. Titov. ". . . This Is Needed for All of Us." Another source says that Grechko's inscription was "We will not engage ourselves with a fantasy." See Vyacheslav Kazmin. "The 'Quiet' Tragedy of EPOS" (English title). *Krylya rodiny* no. 1 (January 1991): 4-5.

117. Lozino-Lozinskiy and Plokhikh. "Reusable Space Systems and International Cooperation," p. 38.

118. Lardier. *L'Astronautique Soviétique*, p. 175; V. Struminskiy. "Hydrogen on Earth and in Space" (English title), undated and unsourced article provided by Christian Lardier; E-mail correspondence, Igor Afanasyev to the author, December 7, 1997.

100-kilometer altitudes, testing them at hypersonic velocities between Mach 3 and Mach 14. Unlike their BOR-1 predecessor, both BOR-2 and BOR-3 were metalloïd vehicles. Their characteristics were:

Model	Length	Mass	Scale to EPOS
BOR-2	3 meters	1.2 tons	1/3
BOR-3	4 meters	1.5 tons	1/2

The BOR-2 and BOR-3 flights allowed engineers to clarify the balance and characteristics of longitudinal stability and compare the data to those from ground wind tunnels. Experimental data were obtained on the conversion of the laminar boundary layer into a turbulent layer and on the effects of altitude and flight speed on the distribution of pressure across the surface of an airframe apparatus with a complex geometric shape. In addition, algorithms for the control of the vehicles' movements were tested, and extensive research was conducted on aerodynamic heating, heat exchange, and thermal protection of various surface elements.¹¹⁹ Despite the significant research in the early 1970s, the program, as a whole, lost sight of its future after Grechko's pronouncement in 1969. The ambitious plans of the mid-1960s—of having a versatile reusable small-scale spaceplane—disappeared amid the military's favoritism for automated systems.

Grechko and Krylov also influenced the course of the NI program. Since the genesis of the program in the early 1960s, Korolev had attempted to interest the military in the rocket's capabilities, knowing that strong military interest would ensure robust funding for the effort. After Korolev's death, Mishin continued to lobby the military, proposing various forms of military complexes that could be orbited by the NI. Research on large-scale space-based armaments systems had begun as early as 1968; in April 1969, Mishin had briefed Soviet leader Brezhnev on the uses of the NI rocket for launching powerful anti-ballistic missile complexes into space. Later, in the autumn of 1969, Mishin had also personally visited the top-secret Institute of Nuclear Physics at Novosibirsk to talk to scientists about the possibility of designing transportable particle beam accelerators that could be launched on the NI.¹²⁰

Many such concepts from TsKBEM were studied in cooperation with various Academy of Sciences and industrial scientific institutes in 1970 and 1971. While these were not programs to which the Soviet government fully committed, they were in fact considered at very high levels. In June 1970, Mishin discussed the prospects of the Luch ("Ray") system, a space-based laser weapons system, with Afanasyev and Keldysh. By September of the same year, concrete work on Luch was planned for 1973, simultaneously with operational launches of the NI booster. Later, in November 1970, Mishin met with Commander-in-Chief of the Soviet Air Defense Forces Marshal Pavel F. Batitskiy to brief him on Luch. All Soviet anti-ballistic missile and anti-satellite forces were under Batitskiy's command at the time. From the available evidence, Mishin faced a very difficult road in convincing military leaders of the need for the NI. As with their American counterparts, Soviet generals and marshals could find little use for very heavy-lift launch vehicles to accomplish military goals. One scientist recalled later that at the initial stages of research on space-based particle beam accelerators, there was a peer review

119. Ageyev, "Unknown Pages of Space Science": Lardier, *L'Astronautique Soviétique*, p. 250; Andrey Batashev, "Steep Turns of the Spiral. A Quarter Century Did Not Suffice for Implementing the Project Created by the 'Father' of the Soviet Shuttle" (English title). *Trud*, June 30, 1994, p. 4; K. K. Vasilchenko, et al., eds., *Letnyye issle dovaniya i ispytaniya. fragmenty istorii i souremennoye sostoyaniye nauchno-tekhnicheskiiy sbornik* (Moscow Mashinostroyeniye, 1993), pp. 34, 54-55. 62: *TsAQI-Osnovnyye etapy nauchnoy deyatelnosti*, pp. 154; Henry Matthews, *The Secret Story of the Soviet Space Shuttle* (Beirut, Leb.: Henry Matthews, 1994), p. 31.

120. Sagdeev, *The Making of a Soviet Scientist*, pp. 123-24.

of Mishin's proposal, and that by the end of 1970, scientists had managed to terminate the project, although Mishin did give a modest contract to the Institute of Nuclear Physics to continue work on the topic."¹²¹

Opening Up

In light of the fundamental connection between the space and military programs of the Soviet Union, it was all the more curious when, in the early 1970s, the Soviets began to very slowly open up their space program to the general public. In an unprecedented act that would have been unthinkable just five years earlier, the Soviet censors allowed the name of Valentin P. Glushko to be published openly for the first time. In March 1971, a one-volume encyclopedia of "cosmonautics" was published, with Glushko listed as its editor. Previous editions had merely listed the editor as G. V. Petrovich, a pseudonym for the chief designer. The Moscow newspaper *Pravda*, in a postpublication article, clearly linked Glushko to Petrovich, confirming what many in the West had long suspected.¹²² That it was Glushko, and not Chelomey or Yangel, whose name was declassified hints at the growing eminence and power the rocket chief designer wielded. Of the six original members of the old Council of Chief Designers, Glushko was the first one to see his name in print after the launch of Sputnik. Few biographical details were, of course, released, and it would not be until the early 1990s before even the name of his organization, the Design Bureau of Power Machine Building (KB EnergoMash), was allowed to be published.

Mishin was also in the news, albeit in an oblique manner. In 1972, a French journalist, Pierre Dumas, authored an article in the journal *La Recherche Spatiale* (Space Research) in which he named Academician Mishin as one of the authors of a project to send "A Manned Space Train to Mars in 1978."¹²³ It was the very first publication linking his name with the Soviet space program. Coincidentally or not, Mishin also wrote his first article for the Soviet media under the pseudonym "Professor M. Vasilyev" in April 1972. In this article in *Pravda*, "Vasilyev" glowingly praised the achievements of the late Korolev." Ironically, at exactly the same time, a Ukrainian emigre published a remarkable analysis of the organization of the Soviet space program. Taking a cue from the French article mentioning Mishin, the author accurately named Mishin as the still-unknown "Chief Designer" of the Soviet space program."¹²⁴ Without exception, all Western analysts, including the CIA, ignored this claim, and for at least the next 15 years or so, "expert observers" in the West continued to tout the names of Yangel or Chelomey as the successor to Korolev.

Unlike Mishin, one employee of TsKBEM was allowed to speak and appear under his own name: Department Chief Boris V. Raushenbakh. In a revelation that caused a mini-sensation in the West, the fifty-five-year-old Raushenbakh was identified as a "specialist in space engineering" during the press conference following the Soyuz 10 flight in late April 1971.¹²⁵ It

121. *Ibid.*, p. 124.

122. "Soviet Space Chief Identified as Editor of an Encyclopedia," *New York Times*, March 19, 1971, p. 3.

123. Pierre Dumas, "Un Train Spatial Habité Vers Mars En 1978," *La Recherche Spatiale* no. 3 (May-June 1972): 26. See also Christian Lardier, "Soviet Space Designers When They Were Secrets," presented at the 47th Congress of the International Astronautical Federation, IAA-96-IAA.2.2 09.

124. Professor M. Vasilyev, "Sputnik: Start of the Space Era" (English title), *Pravda*, April 10, 1972. Further articles under the same pseudonym were published in *Izvestiya* on December 28, 1973, and *Krasnaya zvezda* on April 12, 1974. See also Lardier, "Soviet Space Designers When They Were Secrets."

125. S. Yu. Protsyuk, "Technical Chronicle: Who Runs the Program of Mastering Space in the USSR?" (English title), *Ukrainian Engineering News* 23 (March-April 1972): 60-72. This article is available as NASA Technical Translation TT-14882, dated May 1973.

126. Theodore Shabad, "Soviet Identifies 'Space Specialist,'" *New York Times*, May 2, 1971.

may have been Raushenbakh's considerable talents as a scholar, an orator, a writer, a scientist, and an engineer that posited him with this opportunity. Hailing from German origins, in 1948, he had edited a Russian translation of a classic work by Hermann Oberth on space navigation. He had obtained the equivalent of a Ph.D. in 1958 and became a Corresponding Member of the USSR Academy of Sciences in July 1966. His engineering specialty was satellite orientation systems—a field that he had pioneered in the Soviet Union in the mid-1950s—but his interests were far and wide. He eventually became a doctor of theology, studying the relationship between science and religion, and he wrote several books on the mathematical analyses of perspectives in ancient and modern art.¹

In another unprecedented move, the Soviet government allowed an American journalist to visit the Cosmonaut Training Center. In March 1972, John Noble Wilford, a reporter for *The New York Times*, took a one-day visit to Zvezdnyy gorodok (Starry Town) in support of a page one write-up, which was published later that month. A dark bronze statue of first cosmonaut Yuriy A. Gagarin welcomed Wilford into the closed city, located about forty kilometers north-

east of Moscow near the industrial town of Shchelkovo. As with many secret Soviet cities, Zvezdnyy gorodok was not identified on any public maps and was hidden from the major highway by a forest. By Wilford's estimates, the population of the town was 1,500 to 2,000. He was the first Westerner to see many of the ground trainers used by cosmonauts prior to their flights. While his hosts, cosmonauts Shatalov and Yeliseyev, spoke mostly about the future of Earth-orbital space stations, they did not shy away from the obvious question of a piloted lunar landing. When asked whether Soviet cosmonauts might land on the Moon by 1975, Yeliseyev replied, "Yes. By that time we will probably send our people to the moon." Wilford himself got the impression of an active and expanding Soviet space program.

U.S. perceptions of the Soviet space program in the early 1970s differed dramatically, depending on the perspective. Having fallen prey to Soviet denials about their Moon program, most public observers tended to discount claims by a few lone analysts that the Soviets had ever tried to send cosmonauts to the Moon. The CIA, on the other hand, was clearly in a better position to assess what the Soviets were doing. Through the failures and delays of their lunar program, U.S. intelligence was keyed into the hidden arcana of the Soviet space



Chief Designer Valentin Glushko appears here in his official portrait dating from the late 1960s

His name was officially declassified by Soviet authorities in 1971, the first major chief designer in the Soviet space program to receive this honor before his death (files of Peter Gorin)

¹²⁷ Yaroslav Golovanov, *Korolev: fakty i mify* (Moscow: Nauka, 1994), pp. 575–76. Among other revelations in 1971 was the identification of K. N. Rudnev as the chair of the State Commission for the first Vostok mission in 1961. See "Brezhnev Space Director Since 1963," *Space Daily*, April 15, 1971; Nicholas Daniloff, *The Kremlin and the Cosmos* (New York: Alfred A. Knopf, 1972), pp. 80–81.

¹²⁸ John Noble Wilford, "Soviet Space Center: Hope Amid Expansion," *New York Times*, March 22, 1972, pp. 1–20.

program. In a top secret National Intelligence Estimate issued in March 1970, the CIA very accurately predicted that:

Technical problems with both the [NI] vehicle and the [Proton] booster will delay a manned lunar landing mission until 1973 at the earliest and probably beyond. Nevertheless, a lunar landing mission remains on the books as a venture to be carried out in due course."

CORONA photo-reconnaissance satellites were able to discern remarkable detail of hardware. By the time of their July 1971 estimate, the CIA produced a detailed drawing of the still secret NI and its ground infrastructure. Analysts apparently attributed a far greater ability to the NI rocket than it actually had; according to CIA analysts, the rocket was capable of injecting as much as 125 tons into Earth orbit when its real capability was closer to ninety tons. The errors in analysis were compensated by the speed of information collection; the July 1971 estimate was issued just four days after the third NI launch failure but contained detailed information on the accident. Listing all major liquid hydrogen upper stage programs, the CIA also added quite correctly: "All things considered . . . we think it is unlikely that development of high-energy upper stages has progressed far enough for the Soviets to begin flight-testing them on the [Proton] or the [NI] in the near future."

The Soviets' increased openness and the CIA's much better intelligence collection means were both big factors in the early 1970s as the United States and the Soviet Union engaged in their first major cooperative venture in space in the backdrop of detente. Intensive discussions on a cooperative human spaceflight effort had begun as early as 1969 between then-NASA Administrator Thomas O. Paine and USSR Academy of Sciences President Mstislav V. Keldysh. Apart from the purely political value in support of detente, any potential joint mission would have functional advantages for both sides. For NASA, the year 1972 would be the end of an era in space history as the Apollo lunar landing missions began to wind down. Apollo 16 was set for April 1972, while the last mission, Apollo 17, was scheduled for December 1972. Flights in the NASA Skylab space station program were set for 1973 and 1974, followed by a hiatus in the piloted space program for at least five years before the introduction of the reusable Space Shuttle. A joint flight in the interim period would provide NASA engineers with valuable piloted spaceflight experience. For the Soviets, a joint mission would be most useful from a public relations perspective—that is, to demonstrate that its space technology was on a par with that

129. U.S. Central Intelligence Agency, "National Intelligence Estimate J1-1-69. The Soviet Space Program." Washington, D.C., March 26, 1970, p. 3, as declassified in 1997 by the CIA Historical Review Program

130. CIA, "National Intelligence Estimate 11-1-71. The Soviet Space Program." pp. 10, 12, 13. The actual and suspected characteristics of the NI, called the "J-vehicle" by the CIA, are shown in the following table. The CIA data are from July 1971.

Item	Actual	CIA Estimation
Total Length	105.3 meters (m)	96.6 m
Stage I Length/Base Diameter	30.1 m/116.9 m	25.6 m/17.1 m
Stage II Length/Base Diameter	20.5 m/10.3 m	21.0 m/11.3 m
Stage III Length/Base Diameter	11.5 m/6.0 m	13.1 m/7.9 m
Stage IV Length/Base Diameter	8.0 m/6.0 m	17.4 m/6.1 m
Launch Mass	2,820 tons	4,536 tons
Stage I Thrust	4,615 tons	5,897–6,350 tons
Stage II Thrust	1,432 tons	1,588 tons
Stage III Thrust	164 tons	544 tons
Stage IV Thrust	4 t tons	200 tons
Payload to Low-Earth Orbit	90 tons	125 tons

of the U.S. space program—a claim that had been difficult to support in the previous few years. By early April 1972. Vladimir A. Kotelnikov, the Deputy Chairman of Interkosmos, and George M. Low, Deputy Administrator at NASA, had agreed to a formal technical agreement on the docking of a Soyuz and an Apollo spacecraft in orbit around Earth in July 1975. A formal document, "Agreement Concerning Cooperation in the Exploration and Use of Outer Space for Peaceful Purposes." confirming this arrangement was signed by President Richard M. Nixon and Council of Ministers Chairman Aleksey N. Kosygin on May 24, 1972.¹³¹ The American side called the project the Apollo-Soyuz Test Project, while the Soviets used the phrase Apollo-Soyuz Experimental Flight (EPAS).

The birth of EPAS coincided with major changes within TsKBEM, secretly the prime contractor firm for the joint program. For several years. Chief Designer Mishin had been proposing for a fundamental change in the hierarchical makeup of his design bureau. With the blessing of the Ministry of General Machine Building, on July 14, 1972, the TsKBEM structure was reorganized, for the first time introducing a new level of chief designers within the design bureau. Mishin would remain the Chief Designer and Chief of TsKBEM. Under him, there were six chief designers, each responsible for one of six projects: the N1 rocket, the L3M lunar landing complex, the DOS-7K space station, the 7K-S military Soyuz, the EPAS international project, and the RT-2PU ICBM.¹³² As before, Sergey O. Okhapkin remained Mishin's First Deputy Chief Designer for all programs. Both Mishin and Okhapkin oversaw four other deputy chief designers who were in charge of specific technical areas.¹³³ One of Mishin's key deputies was Konstantin D. Bushuyev, whose name was also added to the growing roster of people revealed to the world. In June 1971, the Soviets named him as the director of the Soviet portion of the Apollo-Soyuz Test Project. The Americans had, for obvious reasons, no knowledge of Bushuyev's extraordinarily important role in the creation of the Soviet space program.

The Soviet public, like those abroad, continued to be fed a steady diet of propaganda concerning their space program. While the space effort may have engendered a strong degree of support in the late 1950s and early 1960s, by the early 1970s, as the country's economy ground into the "great stagnation," people were less prone to be vocally in favor of it. A story in The Washington Post in 1971 illustrates the point. In February 1971, a large portion of potatoes sold in Moscow had been too rotten to eat. Outraged by the dearth in quality in a staple Russian food item, one indignant grandmother declared to a crowd waiting to buy potatoes at a central farm market. "We have rockets, right? Of course, right. We have Sputniks, right? Of course, right. They fly beautifully in outer space. So I say to you, dear friends. Why don't we just send these rotten potatoes into outer space too." There was a small round of applause for her modest proposal. A *New York Times* correspondent added from Moscow that "Although criticism [of the space program] is kept muted by the controlled Soviet media, it is well known here that many Russians are irritated by the costly space ventures when life here is still far from satisfactory."¹³⁴

¹³¹ Ezell and Ezell *The Partnership* pp 182-93 Semenov ed *Rakelno Kosmicheskaya Korporatsiya* p 195

¹³² Semenov ed *Rakelno Kosmicheskaya Korporatsiya* pp 160-639 The six chief designers were B. A. Dorofeyev (N1) V. A. Borisov (L3M) Yu. P. Semenov (DOS 7K) Ye. V. Shabarov (7K S) K. D. Bushuyev (EPAS) and I. N. Sadovskiy (RT 2P)

¹³³ The four deputy chief designers were M. V. Melnikov ("special themes") V. V. Simakin (A. P. Abramov (ground equipment and experimental work) and Ya. I. Tregub (testing and flight control). There were also several deputy chiefs of TsKBEM who were not designers: M. I. Samokhin (standard testing) A. P. Tishkin (coordination) G. M. Paukov (cadres) G. M. Yakovenko (regimes) and B. Ye. Chertok (guidance systems). The First Deputy Chief of TsKBEM was G. V. Sovkov (redesign, construction, and general problems). See *ibid.* p 160.

¹³⁴ The first story is from the March 5, 1971 issue of The Washington Post. The second is from the February 28, 1971 issue of The New York Times. Both are referenced in *Soviet Space Programs, 1966-70: Goals and Purposes, Organization, Resources, Facilities, and Hardware, Manned and Unmanned Flight Programs, Bioastronautics, Civil and Military Applications, Projections of Future Plans, Attitudes Toward International Cooperation and Space Law*, prepared for the Committee on Aeronautical and Space Sciences, U.S. Senate, 92d Cong., 1st sess. (Washington, DC: U.S. Government Printing Office, December 1971), p. 35.

While the criticisms may have been valid, the Soviet public actually knew little about the workings of the Soviet space program. In all unclassified documentation, TskBEM was merely known as the nondescript "post office box number 651." Despite the anonymity, the town of Kaliningrad near Moscow seems to have been a major beneficiary of the massive industrial infrastructure built to support operations at TskBEM. Dozens of high-quality households, apartment complexes, and well-stocked stores were built in the 1960s as more and more engineers from the best educational institutions all over the country joined the design bureau. At the time of the 1972 shakeup, Mishin oversaw an enterprise of 28,959 employees, most of whom were based in Kaliningrad. Because all work at TskBEM was classified top secret, engineers were constantly shadowed by individuals from the "First Department," whose job it was to maintain tight security. As a compensatory measure, wage rates at TskBEM were about 25–30 percent higher than those in similar institutions engaged in scientific or engineering work. Korolev's death, however, seems to have had some deleterious effects on the workforce. A former engineer who emigrated to the West in the late 1970s recalled:

*As long as Korolyov was alive, TskBEM personnel of conscription age were not required to serve in the army. The situation changed dramatically under Mishin. Towards the end of the 1960s all deferments were canceled and men were called up in droves. In June 1968, a virtual round-up was carried out in Kaliningrad. . . . Even though several months later many of the men began returning, one of the incentives for working at TskBEM was gone. Many began to seek jobs elsewhere. It was under these circumstances that the author left TskBEM in 1970. . . .*¹³⁵

Losses in human potential were not limited to TskBEM. In 1971, the Soviet space program lost three of its major leaders. On June 25, 1971, Chief Designer Aleksey M. Isayev of the Design Bureau of Chemical Machine Building in Kaliningrad passed away at the age of sixty-two after a heart attack. His organization, previously known as OKB-2, had designed almost all space-based propulsion systems in the Soviet space program, including those for the Vostok, Voskhod, Soyuz, Salyut 1, and LOK spacecraft. One of the first engineers to travel to Germany in 1945, Isayev had later headed a group at the famous NII-88, where he had led efforts to develop rocket engines for various ballistic, cruise, surface-to-air, and anti-ballistic missiles, eventually moving into the space field. One of his major contributions was the development of the first Soviet high-energy cryogenic engine, created for an upper stage of the NI rocket. Isayev had been offered the honor of becoming an academician of the Academy of Sciences, but he had refused on the grounds that he was an engineer, not a scientist. His name was revealed to the general public only upon his death.¹³⁶

Less than two months later, on August 3, 1971, fifty-six-year-old Chief Designer Georgiy N. Babakin passed away. As head of the design bureau of the S. A. Lavochkin State Union Machine Building Plant since 1965, Babakin had overseen the tremendous successes of the Soviet automated lunar and interplanetary programs. In the piloted space programs, he had played prominent roles in determining policy by participating in various councils involved in the NI-L3 lunar programs. The crowning successes of Babakin's tenure were the Luna 16 soil sample return and the Lunokhod 1 lunar rover missions in late 1970, both of which were critical to

¹³⁵ Victor Yevsikov, *Re-Entry Technology and the Soviet Space Program (Some Personal Observations)* (Falls Church, VA: Delphic Associates, 1982), pp. 1, 3, 5, 12.

¹³⁶ "Aleksei Isayev, Engineer in Russian Space Efforts," *New York Times*, June 27, 1971, p. 46. "Alexei Isayev, Space Scientist Dies," *Washington Post*, June 27, 1971, p. 10; Peter Almquist, *Red Forge: Soviet Military Industry Since 1965* (New York: Columbia University Press, 1990), p. 179, footnote 7. V. N. Bogomolov succeeded Isayev as Chief Designer of KB KhimMash.

supporting the Soviet claim that they were focusing exclusively on automated lunar exploration. One of Babakin's final dreams had been to recover soil samples from the far side of the Moon. Work on such a project had, in fact, begun in 1970 during his lifetime. The plan consisted of an orbiter and a lander—the former to serve as a communications satellite between the latter and Earth. The mission was evidently scheduled for launch sometime in 1972, but after Babakin's death, the idea gradually fell to the wayside, partially because of the high level of technical complexity." Academy of Sciences Corresponding Member Babakin had been working as the deputy chair of the Soyuz 11 investigation commission at the time of his death.

A third loss in 1971 was perhaps the most important from a historical perspective. One of the most influential figures in the Soviet missile and space programs. Chief Designer Mikhail K. Yangel died on October 25, 1971, at the age of sixty." As the architect behind the new generation of Soviet strategic ballistic missiles, Yangel perhaps had more of an influence on the history of the Soviet Union than Korolev. Under his tutelage, KB Yuzhnoye created several high-performance ICBMs, such as the R-16, the R-36, and the R-36M, for the Strategic Missile Forces. In the space sector, his team was responsible for a variety of military satellites and satellite launch vehicles. Yangel had never had a strong interest in the piloted space program, although, from time to time, had tabled proposals such as the R-56 plan for a lunar landing or an even more ambitious Mars mission proposal in 1969. He was also closely involved in the development of the NI-L3 system, participating actively in all meetings related to the program—an interest partly stoked by his organization's help in creating the main lunar lander engine. In the last years of his life, he had been beset by serious illnesses and had had to relinquish some of his day-to-day duties. On his sixtieth birthday, October 25, 1971, there was a big reception in his honor at the offices of Minister Afanasyev. During the celebrations, Yangel complained about not feeling well and went to lie down on the sofa in an adjacent room. For a long time, there was no word from the room. After some time, attendees discovered him dead on the couch. It was his fifth heart attack."

A final transitory event in the space program was not a death, but a retirement. In October 1971, sixty-year-old Col. General Nikolay P. Kamanin formally resigned as the Air Force Commander-in-Chief's Aide for Space, a post he had held since May 1966. Officially, he had been responsible for the Cosmonaut Training Center, the Air Force Biomedical Service, and the Air Force Solar Service. Throughout a ten-year period, Kamanin had not only served as the doctrinal leader of the cosmonaut corps, but also as a vocal and insistent supporter of piloted space programs. Despite speculation in the West that Kamanin was a casualty of a post-Soyuz 11 disaster shakeup, the general had, in fact, decided to retire before the end of that tragic mission.¹³⁹ His role in the Soviet space program has often been compared to that of Donald K. "Deke" Slayton at NASA—that is, as a major player in the selection and training of flight crews. But Kamanin, in many ways, exceeded that mandate by his important contributions to

¹³⁷ "Georgi Babakin Soviet Scientist," *New York Times*, August 5, 1971, p. 36. N. G. Babakin, A. N. Banketov, and V. N. Smorkalov, *G. N. Babakin zhizn i deyatelnost* (Moscow: Adamant, 1996), pp. 73–75. Babakin was succeeded by S. S. Kryukov as Chief Designer of the design bureau of GSKB S. A. Lavochkin.

¹³⁸ Mikhail Yangel, Soviet Space Aide, Chief Designer of Rockets for Exploration Dies, *New York Times*, October 27, 1971, p. 50.

¹³⁹ Khrushchev, *Nikita Khrushchev*, tom 2, pp. 86–87. Yu. V. Biryukov, "Seventieth Birthday of Vladimir Fedorovich Utkin" (English title), *Zemlya i vseleennaya*, no. 3 (May–June 1994), 45–50. Yangel was succeeded by V. F. Utkin.

¹⁴⁰ Kamanin, "This Should Never Happen Again!" no. 24. The decision to replace Kamanin with a veteran cosmonaut was adopted on June 25, 1971, five days before the return of the Soyuz 11 crew. See also "Memorable Dates" (English title), *Novosti kosmonavtiki*, 12–13 (June 3–30, 1996), 76. For Kamanin's appointment to become the Air Force Commander in Chief's Aide for Space, see N. P. Kamanin, *Skrytyi kosmos: kniga utora*, 1964–1966gg (Moscow: Infotekst IF, 1997), pp. 321, 339, 341.

the definition of state policy as well as his direct participation on flight control teams for almost all Soviet piloted space missions between 1961 and 1971. Having retired from the public eye, Kamanin did not return to it. He died on March 13, 1982, at the age of seventy-three.¹⁴¹

Perhaps in retrospect, Kamanin's greatest contributions to the history of the Soviet space program were his personal diaries. Meticulously written between 1960 and 1974, they provide an undeniably rare view into the emergence of the Soviet space effort. With an eye for analysis and reflection, Kamanin recorded much of the arcana of the decade through the lens of an active participant. Even with the declassification of archival material from the early days of the Soviet space program, his journals, which have been published piecemeal by his son in the Soviet and Russian media since 1989, add richly to a history often devoid of documentation. But like most figures of that era, Kamanin wrote with his own biases—prejudices that often leap out of his writings. A diehard Stalinist to the end, Kamanin was quick to criticize everyone but himself in the failures of the Soviet space program, repeatedly castigating Korolev, Mishin, Ustinov, Smirnov, Afanasyev, and many cosmonauts. The cosmonauts, especially, did not have an easy relationship with him. In summing up Kamanin's relations with the cosmonauts, one famous Russian journalist, Yaroslav K. Golovanov, later accurately summed up the general's own personality:



General Nikolay Kamanin was the Air Force Commander in Chief's Aide for Space. His personal diaries, spanning a fourteen year period from 1960 to 1974, have been central to understanding the intricacies of the Soviet piloted space program during the 1960s (files of Peter Corin)

I think that the majority of the cosmonauts did not like him. . . . Some of them confided this to me even back in the 1960s. . . . Kamanin kept a tight rein on them, demanding utter discipline and unquestioning obedience. He indulged himself in what was essentially a lack of responsibility that allowed him to demean young men far superior to himself, and he forced this style of leadership onto the whole first echelon of cosmonauts. To Kamanin it was flattering that these world famous people had to obey him, just like new recruits obey their corporal. It was even easier for him to control the people who still had to make a flight. After all, it largely depended on Kamanin when, with whom, and on which mission they flew. . . . Kamanin was feared, but not loved. Unlike his big idol Stalin, he did not succeed in being loved and feared at the same time.¹⁴²

141. Glenn Fowler, "N. P. Kamanin, Soviet General," *New York Times*, March 15, 1982, p. B6.

142. Golovanov, *Korolev*, p. 665; Bart Hendrickx, "The Kamanin Diaries 1960–1963," *Journal of the British Interplanetary Society* 50 (January 1997): 33–40.

1



CHAPTER EIGHTEEN

ASHES TO ASHES

The early 1970s in the Soviet piloted space program was a period characterized by a noticeable lack of self-confidence. As substantial achievements began to dwindle dramatically, officials and engineers began to grasp desperately for any dim possibility of success. The *Soyuz 11* tragedy was obviously a severe blow, but if Ustinov, Mishin, and others believed that the spate of misfortune was over, they were wrong. In the two years following the deaths of Dobrovolskiy, Volkov, and Patsayev, the Soviet space establishment was beset by failure after failure—at the very same time that the Soviets were engaged in a bid to prove their parity with the United States in space achievements. Ironically, it was precisely during these troubled years that engineers produced, for the first time, a realistic and expansive vision of future space exploration—one that had good reason to succeed. These projects, such as the construction of giant space stations in Earth orbit and the long-term exploration of the Moon, were all, of course, dependent on the political caprices of the key influential players. In the end, as political imperatives had played a role in creating much of the early Soviet space program, they would also play a role in destroying the new vision.

The Multirole Orbital Complex

Throughout the setbacks of the DOS program, Chief Designer Mishin continued to focus efforts at his design bureau on two major long-range goals: the accomplishment of advanced lunar landing missions and the establishment of large-scale stations in Earth orbit. The former consisted of the Multirole Orbital Complex (MOK), whose central element was the Multirole Space Base-Station (MKBS)—a giant space station that had been under study since the mid-1960s. Like the long-term lunar bases that Mishin expected to establish in the 1980s, the MOK, in spirit at least, had more of a connection with the science fiction ideas from the pre-Sputnik era than the incremental developments of the 1970s. These two projects were essentially what he conceived as the first steps in the human migration into space—a vision foretold by the early-century pioneers such as Tsiolkovskiy, Oberth, and Kondratyuk. To Mishin's credit, he made sure that the MOK not only had a cogent vision but also detailed substantiation from a funding perspective.

The basic idea behind the MOK was the establishment of a large-scale complex in Earth orbit to support a variety of goals, all focused on improving life on Earth. The heart of this complex would be the MKBS, a giant piloted space station launched by the NI, which would be tended by a menagerie of smaller spacecraft flying to and from orbital factories. Mishin's own description from 1989 touches on the essence of the effort, which would involve:

a broad program for space exploration in circumterrestrial space within the Earth-Moon radius, including participation in solving food, energy, and ecology problems. Using a minimum number of fully equipped, standard space facilities in ground and orbital bases, the plan was to saturate local space with numerous useful vehicles.¹

Some of the goals of the MOK sounded positively outlandish:

[Elements of the MOK] would even be able to influence the climate and lighting for cities, using a system of mirrors and solar light. It was a quite realistic project. [There would also be the] removal of harmful production facilities into space and full use of the opportunities in space—high and low temperatures, high vacuum, conditions close to weightlessness. And 90 percent of all these operations would be carried out without humans!

The ongoing DOS program in the early 1970s was seen as something of a precursor to the MOK and therefore was seen less as a competitor than a complement to the new proposal. Mishin's timetables were fairly ambitious. By September 1970, he was planning to have the draft plan for the MOK ready by 1972 and to start flying station components into orbit using updated versions of the NI by 1974.² In November 1970, Mishin met with Military-Industrial Commission Chairman Smirnov to discuss the MKBS, but a decision was postponed until further evaluation by a review commission. One of the obstacles to a decision may have been a factor that had perennially slowed down many other programs: interest from the military. In May 1971, Mishin discussed the issue of a military tactical-technical requirement with Commander of the Chief Directorate of Space Assets Lt. General Andrey G. Karas. The possibility of including both passive and active military systems aboard the MKBS had been considered for many years, and some of these proposals were linked to the NI-related anti-ballistic missile systems of the day.

By mid-1971, Mishin's engineers were engaged in revisions of the technical plan for the first two stations, MKBS-1 and MKBS-2, presumably based on military, scientific, and technological limitations. Ustinov's blessing was evidence that the effort was gathering support. In August 1971, a month after the Soyuz 11 disaster, Mishin and Ustinov discussed the long-range plan for Soviet Earth-orbital stations during the 1971-80 period. The Soviet space effort would start off with Mishin's DOS, then move to Chelomey's military Almaz, and then finally migrate to the giant MKBS-1 in the mid-1970s and MKBS-2 by the end of the decade. Mishin already had plans to launch the first components of MKBS-1 on NI boosters IOL and IIL, perhaps amid the initial lunar exploration phase of the L3 project. The last few months of 1971 were an intense period for sharpening the vision of the MOK/MKBS proposal. Discussions focused on technical aspects, such as the docking systems for heavy add-on modules for the station, and managerial aspects, such as the preparation of a formal decree in support of the program. On November 12, 1971, Mishin met with Minister of General Machine Building Afanasyev and his First Deputy Tyulin specifically to discuss the MOK/MKBS proposal. Both agreed to a new tactical-technical requirement, drawn up with the cooperation of the military. The meeting resulted in a recommendation for a Military-Industrial Commission decree on the issue and a rough timetable for the development of the complex. Mishin's engineers could expect to defend the technical plan for the MKBS at the Scientific-Technical Council of the Ministry of General Machine Building by mid-December 1972.

1 A Tarasov "Missions in Dreams and Reality" (English title) *Pravda* October 20 1989 p. 4

2 *Ibid*

3 The updated NI boosters would use the Blok S and Blok S_R upper stages

On February 23, 1972, the Military-Industrial Commission issued a formal decree calling for work on a technical proposal for the creation of the MOK.⁴ As a result, throughout the second half of 1972 and the first half of 1973, engineers at TsKBEM, including several leading Deputy Chief Designers, such as Anatoliy P. Abramov, Boris Ye. Chertok, Mikhail V. Melnikov, and Igor N. Sadovskiy, were involved in drawing up a detailed draft plan for the project. Many other organizations were also involved at this stage of the work.

The MOK as a whole was designed for a wide range of goals in support of science (astrophysical research and "fundamental scientific-technical research in conditions of outer space"), the national economy (the study of Earth's natural resources from space: activities related to guidance, navigation, and communication; research to study forestry, agriculture, geology, and deep sea fishing; and so on), and national defense. The MOK would consist of the following primary components:

- A circumterrestrial orbital system on the basis of the MKBS and autonomous spaceships
- A transport system on the basis of transport supply ships and, in the future, a reusable system and an orbital launch vehicle system
- A ground launch complex
- An automated control system and search-and-rescue complex

The MKBS, as the central link in the system, would serve as the primary place of residence for crews, the orbiting control center, and a base for supply and technical maintenance of the entire complex. Independently functioning apparatus unified with the MKBS would have separate goals, carrying out coordinated activities and maneuvers with their own transport systems.⁵

In designing the MOK, engineers took into account two main limitations: minimum funding and extended operation. Given these requirements, TsKBEM, in its technical plan for the MOK, addressed and adopted specific technical solutions in five major areas:

- To reduce the number of orbital elements while at the same time maximizing the scale of useful activities, engineers used the principles "one and the same goal solved by various apparatus" and "various goals solved by the same ship." In addition, planners selected a Sun-synchronous orbit with an orbital inclination of ninety-seven and a half degrees to achieve the widest range of goals. An increase in the active lifetime of the MOK to up to seven to ten years would be accomplished by making use of reserves and service repair work.
- Designers reduced the required traffic on the "Earth-to-orbit" and "orbit-to-orbit" routes by using the lowest number of consumed materials. Specifically, they used reserve propellants to maintain the complex's orbit and orientation (with electric engines), exposed film and reentry capsules for their delivery (by transferring urgent information by radio and delivering less urgent information to Earth by transport and supply ships), and special light modifications of 7K Soyuz-type ships with remote manipulator arms for intersatellite transport. Also, autonomous modules based on the MKBS would engage in regular repair work.
- Engineers reduced the cost of developing MOK systems by maximizing the use of auxiliary systems and apparatus of standard size and form that had already been developed, but with the necessary modifications. Continuity between previously created and proposed materials would be partly facilitated by the use of 7K Soyuz-type ships launched on the Soyuz booster. Apart from its direct use as a transport ship, engineers proposed automated

⁴ Yu P. Semenov ed. *Raketno Kosmicheskaya Korporatsiya "Energiya" imeni S. P. Koroleva* (Korolev RKK Energiya named after S. P. Korolev 1996) p. 639

⁵ *Ibid.* p. 278

modifications in the form of "multi-goal visiting modules." In addition, they would use a new modified spacecraft module, the 19K, launched on the Proton booster, as a modified observation module, as well as heavier special modules launched by the N1. Using upper stages such as Blok S_R, the N1 would be able to launch special apparatus for the MOK to geostationary orbit.

- Engineers would make maximal use of already developed ground-based systems to support MOK operations, such as current launch complexes and the ground tracking network.
- Finally, planners expected to reduce the cost of transportation for orbital operations on the MOK by limiting operations as much as possible to a single orbital plane coinciding with the inclination of a standard Sun-synchronous orbit. TsKBEM would also develop new economical reusable transport systems, allowing for the lifting of payloads and consumables to polar orbits at inclinations of ninety-seven and a half degrees or higher.⁶

One of the main selling points of the MOK, according to its developers, was its great flexibility and adaptability in relation to its program of research—that is, the design of the complex would make it relatively easy to change and renovate the makeup of the orbital system without disrupting the basic interconnected functionalism. The creation of the MOK would unfold in two major phases: the first in an experimental orbit at a fifty-one-and-a-half-degree inclination and the standard at an inclination of ninety-seven and a half degrees at 400 by 450 kilometers.

Obviously, one of the main links in the creation of the MOK was the N1 launcher, which in its N1F configuration would be the primary launch vehicle for elements of the MKBS portion. Engineers also explored the possibility of using a partially reusable version of the N1—a rocket whose first stage, Blok A, would be powered by combined liquid and air-compressed engines firing on the liquid hydrogen-liquid oxygen (LOX) combination.

The MKBS, the main component of the MOK, looked roughly like a giant pencil in orbit and probably had design elements common to the abandoned Martian piloted spaceship proposal from 1969. At one end of the spacecraft, there was a nuclear energy unit and electric plasma engines to maintain attitude and altitude. The primary engine complex of the MKBS would use liquid-propellant rocket engines with thrusts of 300–1,000 kilograms. Attitude would be maintained by a combination of liquid-propellant (ten to forty kilograms thrust) and electric engines (100–300 grams thrust). The nuclear power unit would supply the primary power to the station, about fifty to 200 kilowatts. Solar panels, with a total surface area of 140 square meters and jutting out from various points along its main body, would provide an additional fourteen kilowatts. The nuclear energy unit was placed as far away as possible from the habitation quarters, which were on the other side of the "pencil." This opposite end would begin with a large compartment for "scientific and special equipment." Total scientific instrumentation on the MKBS would comprise about fifteen to twenty tons. Moving aft, there would be a multiple docking adapter, much like the one later used on the Mir space station, but far bigger. Here, at least four visiting spacecraft would dock, some of them based on the 7K Soyuz design and some of them "special modules." The docking adapter was connected to the main living and working quarters—a huge cylindrical compartment, about the size of Skylab, for crew activities. There would be six permanent crewmembers on the MKBS and up to ten for short periods. In the first two years of operation, crews would switch over about two times a year. The life support system would have a reserve of 1,100 crewperson-days with the capability to regenerate water from condensate. Ultimately, the atmosphere and water would be fully regenerated from the life support system.

6. *Ibid.*, pp. 278–79.

Further aft, there was the instrument and aggregate compartments, containing a variety of instrumentation to support MKBS operations in Earth orbit. About one-third of the way down the "pencil," the station had two long arms, each twenty to thirty meters long and 180 degrees apart, both of which ended in small cylindrical compartments. Here, in these modules, each with a volume of twenty-five to thirty cubic meters, cosmonauts could spend time and enjoy the effects of artificial gravity from the spin around the station's main axis. According to preliminary calculations, an angular velocity of a half degree per second would generate up to 0.6–0.8 g's. The central node for these artificial gravity arms would also include an EVA airlock. Moving aft down the station, the cosmonauts would then find the main laboratory quarters, yet another cylindrical module, with its own adjacent multiple docking adapter with four ports. Here, the station proper would end, and three long pylons, about half the length of the station itself, would extend aftwards, ending in the nuclear reactor package on the other end. The total mass of the MKBS with four attendant visiting modules would be in the range of 220 to 250 tons, requiring assembly in orbit because the NI would be rated at eighty to eighty-eight tons of useful payload. The station would have a total length of about 100 meters and a main body diameter of about six meters. Each MKBS was expected to function about ten years in orbit.'

Like the L3M lunar landing plan and its related Long-Duration Lunar Base, the MOK proposal was clearly a leap in ambition and capability rather than the incremental advances to which the Soviets were generally prone. While the fantastic nature of these plans would give pause to any American conception of a space program in the 1970s, the Soviets, despite losing the race to the Moon and despite the series of attendant disasters that plagued their piloted program in the early 1970s, saw these proposals as vehicles for regaining some lost glory. Thus, both at a designer level—in particular Mishin—and at a bureaucratic level—Ustinov, Smirnov, and Afanasyev—these proposals were taken very seriously and were incorporated into the long-term vision of the Soviet space program. In 1971, this vision was, however, less of a problem than the short-term one. Having just recovered three dead cosmonauts from orbit, any clarity about regaining momentum was lost amid continuing setbacks in the small space station program.

Trying to Fly

In the immediate post-Soyuz 11 disaster climate, it was clear that there would be no further missions to the first *Salyut* station.⁷ One possibility was to fly the long-delayed dual

⁷ *Ibid.*, p. 410

⁸ One unconfirmed report suggests that there may have been brief plans to fly a short Soyuz mission to the *Salyut* station in September 1971. The crew would have been A. A. Leonov, P. I. Kolodin, and A. A. Cubarev. See Mikhail Rebrov, *Kosmicheskiye katastrofy: stranichki iz sekretnogo dosye* (Moscow: Ekspress NV, 1996), pp. 72–73.

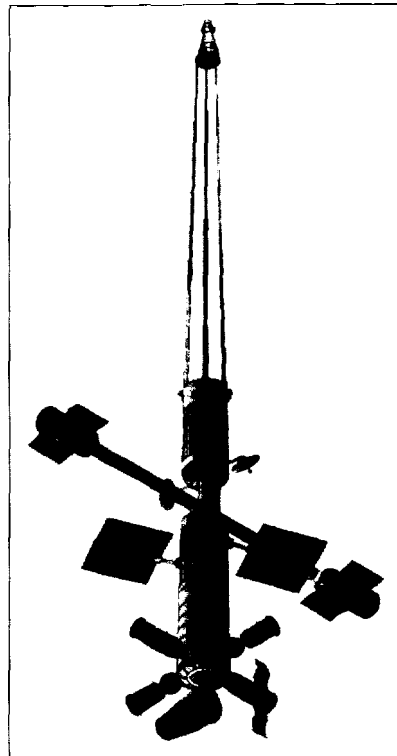

This is a drawing of the Multirole Space Base Station (MKBS), the huge Earth orbital complex proposed by Vasily Mishin in the early 1970s (copyright Mark Wade)

Soyuz-docking mission to test the Kontakt rendezvous radar system slated for use on the lunar landing project. Conceived sometime in 1968, the mission was repeatedly delayed because of poor results during the system's ground testing. In May 1970, the docking mission was set for August of the same year, using 7K-OK vehicles 18 and 19. The flight was then delayed to October 1970. Eventually, space program head Ustinov opted to delay the Kontakt flight in favor of the DOS space station flights in 1971, thus moving the docking flight further back to late 1971. At least four crews for the mission, including primary crews of Filipchenko with Grechko and Lazarev with Makarov, continued their training despite the increasingly gloomy prospects.⁹ With the slowdown of the original L3 plan and the imminent adoption of the new L3M project, Kontakt lost much of its importance. In October 1971, Mishin officially closed down Kontakt.¹⁰ Crews training for the mission were instead transferred to training for other projects.

With the prospect of piloted flights only within the framework of orbital stations in the near future, the focus of discussion shifted to both the DOS-7K complex and Chelomey's Almaz space station. In early August 1971, Mishin met with Ustinov to discuss long-term plans. Ustinov was clear on several points, including the urgent need to accelerate work on the *Sokol-K1* spacesuit for the Soyuz spacecraft. In addition, he made it clear that he wanted the next Soviet space station to be Mishin's DOS rather than Chelomey's Almaz. All resources should be marshaled so as to launch the next DOS before NASA's much larger Skylab space station. Based on the discussions, Mishin had a provisional schedule for work on the DOS:

Station	Launch	No. of Visits	Visiting Ship
DOS-2	First quarter of 1972	3 to 4	7K-T Soyuz
DOS-3	Fourth quarter of 1972	3 to 4	7K-T Soyuz
DOS-4	Fourth quarter of 1973	4	7K-S Soyuz

The 7K-T Soyuz variants would be equipped with the old Igla rendezvous system, while the advanced 7K-S Soyuz would have a new system, designated *lira*. Each DOS spacecraft would have a four-month lifetime for its life support system and a six-month lifetime for all other systems. The urgency of launching the next DOS as soon as possible was underlined at a meeting in early November 1971 that was attended by all the major leaders of the Soviet space program.¹¹ There was a general consensus that DOS-2 should be launched so as to take some of the publicity from the Apollo 16 Moon landing planned for April 1972.

In October 1971, Col. General Kamanin retired from his post as the manager of the cosmonaut corps and was replaced by Maj. General Vladimir A. Shatalov, the forty-four-year-old veteran cosmonaut. It was a very powerful rank for a cosmonaut to hold, and his appointment order, signed earlier in June 1971, probably stemmed from Shatalov's cool disposition during his three Soyuz missions during 1969-71. One of Shatalov's first actions was to select crews for the DOS-2 space station flight. For the honor of the first visiting mission, he picked the Leonov-Kubasov team that would have flown on the ill-fated Soyuz 11 had it not been for Kubasov's

⁹ The four crews in December 1970 were A. V. Filipchenko/G. M. Grechko, V. C. Lazarev/O. C. Makarov, L. V. Vorobev/V. A. Yazdovskiy, and C. T. Dobrovolskiy/V. I. Sevastyanov.

¹⁰ K. Lantratov, '20 Years From the Flight of Soyuz 12' (English title) *Novosti kosmonautiki* 20 (September 25-October 8, 1993) 39-41.

¹¹ In attendance among others were D. F. Ustinov (Secretary TsK KPSS), I. D. Serbin (Chief TsK KPSS Defense Industries Department), M. V. Keldysh (President AN SSSR), G. A. Tyulin (First Deputy Minister MOM), A. I. Tsarev (Deputy Chairman VPK), B. A. Komissarov (Department Chief VPK), B. A. Stroganov (TsK KPSS Defense Industries Department), and K. A. Kerimov (Chief Third Chief Directorate MOM).

brief illness." Given the success of the first mission, there would be two or three additional flights to the station. For reasons that are not clear, the DOS-2 launch was significantly delayed from the first quarter to the beginning of the third quarter of 1972. The delay may have had less to do with the station itself, which was almost identical in design to the first Salyut, than problems with requalifying the 7K-T Soyuz spacecraft for flight. To test the improved life support systems with the new Sokol-K1 spacesuits, Mishin inserted a flight of an automated Soyuz into the schedule. It would be almost an entire year after the Soyuz 11 disaster that this Soyuz would be ready for launch.³

Soyuz 7K-T spacecraft no. 33L was launched successfully at 1453 hours Moscow Time on June 26, 1972, into an initial orbit of 195 by 342 kilometers at a 51.6-degree inclination. The spacecraft was named *Kosmos-496* upon entering orbit. Little is known about the flight except that there was one orbital maneuver. After about six days in orbit, the descent apparatus separated from the rest of the vehicle and returned to Earth. The successful mission gave some much-needed confidence to the continuing preparations for the next DOS flight. Crews for the first flight flew into the Baykonur Cosmodrome in preparation for their own launch. By this time, the usual rumors were mounting in the West that a spectacular mission was imminent. On March 9, 1972, the Paris-based *Agence France Presse* reported that two crews were ready to fly to a new *Salyut* space station for missions lasting up to thirty days.⁴ Shatalov added fuel to the rumors by telling the Czech press in early April that there would be additional piloted missions "probably this year."⁵

The State Commission for Soyuz, still headed by Maj. General Kerimov, approved the launch of DOS-2 for late July 1972. Subsequently, *Soyuz 12* with Leonov and Kubasov would lift off during the last week of August. Another crew, Lazarev and Makarov on *Soyuz 13*, would fly to the station in the third week of October 1972. All these plans were not to be. The twenty-ton space station, spacecraft no. 122, was launched in the early morning, at 0620 hours, 57 seconds Moscow Time, on July 29, 1972, on top of a three-stage Proton booster. During the boost phase, at T + 162 seconds, the control systems of the second stage of the launch vehicle failed, preventing orbital insertion. The mission had to be aborted. U.S. over-the-horizon sensors evidently monitored telemetry from the launch attempt, prompting subsequent news reports that one of the four second-stage engines had stopped firing during the ascent through the atmosphere.⁶

The loss of DOS-2 continued the series of strikes against the Soviet piloted space program. To take advantage of two flight-ready 7K-T Soyuz vehicles, which had been ready to deliver crews to the lost station, the State Commission in August 1972 considered launching a single Soyuz on a solo mission in Earth orbit, primarily to test the new spacesuits and redesigned

12 Four crews trained for DOS 2: A. A. Leonov/V. N. Kubasov, V. G. Lazarev/O. G. Makarov, A. A. Gubarev/G. M. Crechko, and P. I. Klimuk/V. I. Sevastyanov. See Lantratov, "20 Years From the Flight of Soyuz 12." Note that originally, in September 1971, the Gubarev and Klimuk crews were slightly different. See S. Shamsutdinov and I. Marinin, "Flights Which Never Happened" (English title) *Aviatsiya i kosmonautika* no. 3 (March 1993): 43-44.

13 A prototype of the Sokol-K1 suit was produced in 1971, with further revisions added between August 1971 and March 1972. See *Russian Space History*, Sale 6753 (New York: Sotheby's, 1996), description for Lot 147.

14 Agence France Presse, untitled press release, Paris, 1554 GMT, March 9, 1972, in English.

15 *Soviet Space Programs 1971-75: Overview, Facilities and Hardware*, Manned and Unmanned Flight Programs, Bioastronautics, Civil and Military Applications, Projections of Future Plans, prepared for the Committee on Aeronautical and Space Sciences, U.S. Senate, 94th Cong., 2d sess. (Washington, DC: U.S. Government Printing Office, August 1976), p. 534.

16 V. M. Petrakov, "Soviet Orbital Stations," journal of the *British Interplanetary Society* 47 (September 1994): 363-72. I. B. Afanasyev, "Unknown Spacecraft (From the History of the Soviet Space Program)" (English title), *Nouoye i zhizni: Nauka i tekhnika. Seriya kosmonautika i astronomiya* no. 12 (December 1991): 1-64. "Orbiting of Second Salyut Ends Soviets Hiatus in Manned Space," *Aviation Week & Space Technology*, April 9, 1973, p. 21.

systems aboard the ship. Crews began training for this flight, scheduled for sometime in late August or early September 1972 on vehicle no. 34. After roughly a month of preparations, two crews—Cubarev-Crechko and Klimuk-Sevastyanov—successfully passed their final exams, but by this time, the commission began to get cold feet. Members expressed reservations for such a flight, believing it to be "inopportune," most likely because a solo Soyuz flight in Earth orbit would pale in comparison to the impending launch of Apollo 17 in December 1972. The solo flight was canceled."

Besieged by failure and delays, the Soviet space station program needed some drastic help. Assistance came from neither Ustinov nor Afanasyev, but rather from the unlikely person of General Designer Chelomey and his Almaz space station program. Since the February 1970 decision to move ahead with DOS at the cost of delaying Almaz, Chelomey had doggedly and quietly pursued work on his coveted station, methodically coordinating his efforts with his primary clients, the Ministry of Defense. Although the focus of activities at the massive Khrunichev Plant during 1970-72 was on the DOS effort, representatives from Chelomey's TsKBM continued work on their own space station hulls. Engineers tested an updated version of the Almaz control system on a complex test rig. Tests of the Almaz power system included firings of the flywheel micro-liquid-propellant rocket engines at a test stand near Moscow. Various hulls were remanufactured for Almaz, including those for stress, vibration, and heat testing. A special orbital block simulator was also built at the Institute of Aviation and Space Medicine, where testers spent thirty-six days in a "flight regime," which ended on January 11, 1972. After their "mission," they reported back that "the configuration of the work and living compartments is comfortable," that "the air is good and odorless," and that they had "soon become used to the hum and vibrations caused by the instruments."¹⁸ Crews whose missions had been sidelined because of DOS resumed their training on station components in hydrolabs and aboard Tu-104 aircraft.

In the original conceptions of the Almaz space station from the mid-1960s, Chelomey had always envisioned his station as an orbital complex rather than simply a station supplied by small ferry vehicles such as the DOS. The key to these plans was the use of a large module, about the size of the Almaz station itself, which would not only serve as a ferry craft for crews, but also add significantly to the volume and capabilities of the station once linked to the station proper. Most likely because of an overload of work, Chelomey was unable to carry out substantial work on this add-on module, called the Transport-Supply Ship (TKS). Like many of his other projects, he entrusted the work on developing the TKS to his Moscow Branch headed by First Deputy General Designer Viktor N. Bugayskiy. There, under Bugayskiy's overall supervision, engineers completed the initial technical project for the TKS (or product 11F72) in 1969." While the decision to create Mishin's DOS in February 1970 may have delayed the overall Almaz program, it does not seem to have squelched Chelomey's ambitions of creating the TKS. With Minister of Defense Crechko's support, Chelomey managed to extract an official promise to commit to developing the TKS. On June 16, 1970, the Central Committee and the Council of Ministers issued a decree (no. 437-160) that officially approved the TKS program. The TKS would have the following goals:

- 17 Lantratov "20 Years From the Flight of 'Soyuz 12'"
- 18 Vladimir Polyachenko "The Pep of Almaz" (English title) *Krylya rodiny* no. 1 (January 1992) 18-19
- 19 S. A. Zhiltsov, ed. *Gosudarstvennyy kosmicheskiy nauchno proizvodstvennyy tsentr imeni M. V. Khrunicheva* (Moscow: RUSSLIT, 1997), p. 89

- Docking of twenty-ton spaceships to each other (the TKS and the Almaz)
- Delivery and return of crews from the Almaz station
- Delivery of supplies and apparatus for carrying out functional work on the Almaz station
- Delivery of life support supplies for the crew
- Raising of station orbits
- Orientation and extended (up to ninety days) control of the flight of the entire complex
- Possibility of autonomous descent from orbit"

In its design, the TKS served as a direct intermediary between early Chelomey designs, such as the lunar LK-1 and LK-700 spacecraft from the 1960s, and the Mir modules and Zarya module of the International Space Station in the 1990s. The spacecraft consisted of two major components: the return apparatus and the functional cargo block (FCB). The reusable return apparatus (or product 11F74) was almost identical to the one used on the original Almaz station for returning crews to Earth. At some point in 1968, Chelomey had evidently abandoned the use of this large module on the Almaz station, opting instead to use the smaller Soyuz to return crews from the station. There were probably also technical considerations, because the hatch-in-the-heat-shield design necessitated a long and exhaustive series of tests to verify its safety before use with crews.

The functional cargo block (or product 11F77) was a large and roughly cylindrical structure connected to the base of the return apparatus. At the base of the FCB, the cylindrical shape expanded into a skirt with a maximum base diameter of 4.15 meters. The spacecraft was completed by a terminal cone fixed at the flat base of the cylindrical skirt with the apex facing aft. The main body diameter of the FCB was 2.9 meters, the same as that for the smaller section in the Almaz space station. The docking assembly of the TKS was located at the aft end of the spacecraft in the larger diameter area. After rendezvous with the Almaz station, the crew, in spacesuits, would be next to the docking assembly and observe operations through a viewport. The simplified docking procedure and expanded view would make it possible to abandon the cumbersome system of periscopes and TV cameras used on the Soyuz spacecraft. The docking assembly itself was significantly different from that used on the 7K-T Soyuz; time from the moment of docking to hatch opening would be three to four minutes, as compared to the eighteen to twenty minutes on the Soyuz-DOS combination. One of the supplementary goals of the TKS was to deliver the small recoverable capsules used on the Almaz station to return exposed film of military targets from space. Overall, the TKS would have a mass of just over twenty-one and a half tons at launch and seventeen and a half tons in orbit; it would afford as much internal space as the Almaz space station. Two Almaz-type solar arrays with an area of forty square meters would provide about three kilowatts of power. It would be both a qualitative and quantitative leap in abilities over the modest Soyuz ferry spacecraft."

As a result of cumulative delays, the TKS was not expected to fly operational missions prior to the mid-1970s. In the meantime, in 1971, Chelomey had signed an agreement with Mishin to use variants of the 7K-T Soyuz spacecraft to deliver and recover crews from the Almaz space station. Work on this version of the Soyuz began the same year, and by early 1972, TsKBEM's Department No. 037 had completed the redesign of the 7K-T to support piloted missions to

20. *Ibid.*, p. 88.

21 Afanasyev. "Unknown Spacecraft"; Zhiltsov, ed., *Gosudarstvennyy kosmicheskiy*, pp. 88-89; Nina Chugunova. "Chelomey's Cosmonauts: Why There Are No Crews From NPO Mashinostroyeniya in Outer Space" (English title), *Ogonek* 4-5 (January 1993), 24-29.

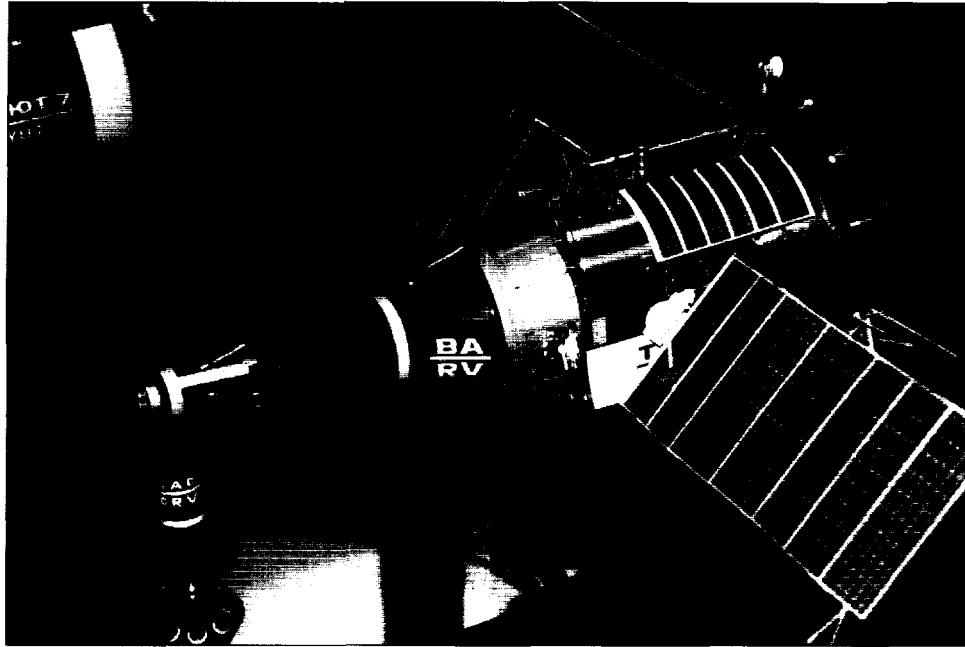

Here is a model of Vladimir Chelomey's Transport Supply Ship (TKS) which was meant to be part of the Almaz military space station complex. The conical segment at the left is the reentry capsule, apparently patterned after the US Air Force's Gemini B spacecraft. The vertically placed component at the left is the launch escape system. (copyright Dietrich Haeseler)

the Almaz station." By May 1972, four crews were in the midst of intense preparations for the first missions to Almaz.' Thus, by mid-1972, the Soviet Union had two full-fledged and parallel space station programs—one dedicated to primarily civilian goals, Mishin's DOS, and one for military research, Chelomey's Almaz. The path of these projects had always been interdependent, but in mid-1972, they forged a most unlikely alliance.

For Mishin, the DOS had always represented an unnecessary diversion from what he considered the main thematic directions of work at the design bureau: large-scale space stations such as the MOK and the lunar landing project. The DOS project had essentially been hoisted upon him at a most inconvenient juncture. That TSKBEM had managed to fulfill the original order within the given period of one year was partly because Mishin had been forced to redirect much of the resources at the design bureau to the DOS program. Mishin's primary goal was to shift the focus back to his two pet projects—the MOK and the L3M. Both had received resounding shows of support with official decisions in February and May 1972, respectively. It was time to make sure that the DOS did not hinder their implementation. At the same time, Chelomey had every reason to resent the DOS space station program—an effort that had been essentially appropriated from his own coveted Almaz project. Having seen the latter sidelined by the DOS, Chelomey was in the unlikely position of being of the same mind as Mishin on

22 Semenov ed *Raketno Kosmicheskaya Korporatsiya* p 190 Both the DOS and Almaz versions had the same design bureau designation—that is 7KT—but had different production designations: 11F615A8 (for DOS) and 11F615A9 (for Almaz)

23 These four crews were P R Popovich/L S Demin G V Sarafanov/Yu P Artyukhin B V Volynov/V M Zholobov and V D Zudov/V I Rozhdestvenskiy

this matter—that is, the small space station program, specifically the DOS and Almaz, needed to go back to Chelomey. With this in mind, on April 14, 1972, Mishin and Chelomey signed an agreement proposing to Minister of General Machine Building Afanasyev that after the first four DOS space stations, work on the project would be terminated. In addition, all continuing research for science and the national economy would be carried out on Almaz space stations, in addition to its own primarily military activities. Initially, the Almaz space station would be serviced by the 7K-T Soyuz, then eventually the advanced 7K-S Soyuz, and finally the TKS. One final note in the letter was to use a proposal allowing the use of Chelomey's TKS on Mishin's MOK.²⁴

There was apparently much opposition *within* Mishin's design bureau against this unlikely alliance, presumably from individuals, such as Bushuyev and Feoktistov, who had wholeheartedly thrown their lot in with the DOS program. Minister Afanasyev, however, under "pressured circumstances," agreed to ratify the proposal, giving it his signature on April 21, 1972. In retrospect, this agreement was quite possibly the origin of a serious fracture within TsKBEM between the "pro-lunar program" and the "pro-DOS" factions. The hostilities that would build from this decision would prove to have cataclysmic consequences. While Mishin may have believed that an agreement to hand over the DOS to Chelomey was a pragmatic choice at the time, it is clear that he neglected to consider the personal and managerial consequences within his own organization. Worse for Mishin, while he had strong supporters for the lunar program and the MOK, his opponents were formidable, including Deputy Chief Designers Bushuyev and Chertok and the influential Department Chief Feoktistov.

The Mishin-Chelomey agreement in April 1972 meant that Almaz was less of a competitor than a complement to the DOS. New flight models of both stations were, by coincidence or not, ready to fly by early 1973. Mishin's new DOS vehicle, spacecraft no. 123, differed in many respects to its two predecessors launched in 1971 (as *Salyut*) and in 1972 (the launch failure). The original design, while adequate given the short timeframe for its creation, had some major shortcomings, limiting the effective use of the station. One of these design compromises was the configuration and location of the station's two solar panels. To have these panels face the Sun on the original *Salyut*, crews had to turn the entire station and maintain attitude continually to receive power. This resulted in high consumption levels for the on-board propellant, which was in relative short supply. The complicated solar orientation system also affected the amount of scientific experimentation possible on the station because of fluctuating power levels. The primary difference of the "new" DOS, whose development had actually begun as early as 1970, was to remove the two pairs of solar panels and instead install three self-rotating solar panels, which would turn around their own axes independently of the station. The three new panels, appropriated from Chelomey's TKS, would be installed directly in a "T" shape on the main working compartment and provide over two times more power than the earlier ones. To compensate for the additional mass from the new panels, engineers removed the number of tanks from the main engine unit. To reduce the amount of propellant required to maintain a working orbit, planners also increased the operational orbit to an altitude of 350 kilometers."

There were many other changes in this "second-generation" DOS. Engineers designed a new "highly economical" orientation system named *Kaskad* and an experimental navigation system called *Delta* to replace the older ones. There was also a new thermo-regulation system

²⁴ The entire letter has been reproduced in Semenov, ed., *Raketno-Kosmicheskaya Korporatsiya*, pp. 295–96. An additional point in the letter addressed the use of the Soyuz (a variant known as the 7K-M) instead of the *Salyut* space station for the Apollo-Soyuz Test Project.

²⁵ *Ibid.*, p. 271; Afanasyev, "Unknown Spacecraft."

and an early version of a closed-cycle water supply system using the SRV-K water regeneration device. The total guaranteed lifetime of the station was increased from the ninety days for the first DOS to 180 days on the third one. The scientific complement was slightly different from the earlier model. The new one included a Roentgen telescope-spectrometer, the RT-4 Roentgen telescope mirror, and the ITS-K infrared telescope. Finally, there were some cosmetic changes, such as thicker walls, an altered frame, changes in the aggregate compartment, and the use of a unified welding installation in the main scientific apparatus compartment."

There were additional changes to the 7K-T Soyuz ferry in 1972 and 1973. Anticipating that a ferry vehicle would not need to fly independently for more than two days, engineers deleted the two heavy solar panels from the spacecraft, making the ship rely completely on its modest internal chemical batteries. These batteries could be recharged once docked to a space station using power generated from either the DOS or Almaz. The mass of this second iteration of the Soyuz ferry was about 6,800 kilograms, up from the original 6,700 kilograms.

By the time that these changes were made to the DOS and Soyuz designs, Chelomey was well advanced with preparations for the launch of his own first Almaz station. On June 15, 1972, a decree of the Ministry of General Machine Building specified a schedule for immediate operations in the Almaz program. The Khrunichev Plant was to complete the assembly of the first flight model of the Almaz station and deliver it for preliminary testing by June 30, leading to delivery to the testing station at the Baykonur Cosmodrome by November of the same year." If all went well, the launch would take place in late 1972 or early 1973—that is, at about the same time as Mishin's DOS-3. The concurrent and timely preparations were very much colored by activity in the United States. NASA at the time was wrapping up final preparations for the launch of its first space station, Skylab, scheduled in April 1973. If successful, it would host three crews during the year, with missions lasting twenty-eight, fifty-six, and fifty-six days, respectively. Having taken the lead in terms of space stations, with *Salyut*. Soviet space officials, especially Ustinov, were particularly sensitive to the possibility that Skylab would completely overshadow the achievements of *Salyut*. It was absolutely imperative that the Soviet Union have a space station in orbit before Skylab. Luckily for Ustinov, both Mishin and Chelomey were ready with their respective space stations at just the right time. It seems that Ustinov, as a means to upstage Skylab, wanted to fly both the DOS and Almaz in 1973. Given Ustinov's predisposition to oppose Chelomey, one would have expected the DOS to have the honor of going first, but evidently in October 1972, Soviet leader Brezhnev had the last word: Chelomey's Almaz would get the first try."

The first Almaz station, vehicle no. 101-1, arrived at the Baykonur Cosmodrome in January 1973. Ground testing was completed within three months. The fact that Mishin's DOS was also undergoing ground testing at the launch site simultaneously led to problems because of stretched resources. Both stations used the same pressure chamber and fueling stations. In fact, there was a great degree of cross-pollination between the two programs, partly because TsKBEM engineers had to be involved in the Almaz effort as they were responsible for the Soyuz spacecraft." Four

26 Semenov ed *Raketno Kosmicheskaya Korporatsiya* p 272 Petrakov. "Soviet Orbital Stations "

27 Zhiltsov ed *Gosudarstvennyy kosmicheskyy* pp 78-89 The order also specified the details of manufacture. All production would be carried out at the M. V. Khrunichev Machine Building Plant for the prime customer which was TsKBEM (for all components except the transfer compartment and the engine unit for which the customer was TsKBEM's Fili Branch). In addition, the order specified that the Khrunichev Plant would complete production preparation for the manufacture of the TKS blocks in the fourth quarter of 1972.

28 The first Almaz was originally scheduled to fly in December 1972, but there were serious delays in the delivery of subsystems. MOM First Deputy Minister Tyulin finally issued a memo to Chelomey on November 23, 1972, noting that because Skylab would fly by April 30, 1973, the first Almaz had to be in orbit by March 1973.

29 Semenov ed *Raketno Kosmicheskaya Korporatsiya* p 273 Afanasyev "Unknown Spacecraft" Shamsutdinov and Marinin "Flights Which Never Happened" V Polyachenko and A. Tumanov "From the History of Space Science: The Controllable Almaz" (English title) *Aviatsiya i kosmonavtika* no. 8 (August 1993) 41-43

two-person crews were on standby for two consecutive missions to the station—the first consisting of cosmonauts Popovich and Artyukhin lasting fifteen days and the second made up of Sarafanov and Demin. There were apparently serious problems with the Soyuz parachute system that threatened to disrupt the Almaz schedule. Despite these potential disruptions, Chelomey pushed ahead with the liftoff.

Launch day for the Almaz station was April 3, 1973, a little more than a month before the Skylab launch. As the clock ticked down to booster ignition, at T-15 minutes, there was a sudden alarm: propellant was apparently leaking from the Proton rocket's filling system. The danger of a terrible explosion was on everyone's mind. Chelomey fearlessly announced that he wanted to go directly to the pad. After an inspection of the situation, he returned to the blockhouse and recommended that the launch proceed. State Commission Chairman Col. General Mikhail C. Grigoryev of the Strategic Missile Forces concurred, and at exactly 1200 hours Moscow Time on April 3, 1973, Almaz lifted off into the sky, eventually entering an initial orbit of 215 by 260 kilometers at a 5.16-degree inclination.³⁰ A full thirteen years after proposing his first space project, Chelomey had finally launched a piloted spacecraft into orbit around Earth, the first piloted military spacecraft in space.

Chelomey might have been forgiven for believing that his beloved space station would be named *Almaz* by the Soviet press. But highly placed space officials, possibly including Ustinov, were adamantly opposed to this. Some have claimed this was because they "were dead against the presence of a second figure in the Soviet space program."³¹ Others believe it was to hide the fact that Almaz was a purely military space station.³² In any case, Chelomey, apparently humiliated, was explicitly ordered to have the name *Salyut 2* painted on the station. The shrewd general designer told his engineers to paint the offending name on the outside fairing of the station; once the fairing jettisoned in the upper reaches of the atmosphere, the station revealed Almaz clearly written on it. The Soviet press, of course, referred to it as *Salyut 2*. Launch of the first crew, on Soyuz 12, had been planned for April 13, but had to be delayed to May 8 because of continuing problems with the Soyuz parachute system. In their initial press releases on the mission of the station, the Soviets refrained from making any connection with piloted flights. At least two major orbital corrections, on April 4 and 8, resulted in a new orbit of 261 by 296 kilometers.³³

Throughout the first few days in orbit, the Chief Operations and Control Group at Yevpatoriya, led by Yakov Ya. Sirobaba, tested the attitude control systems, life support systems, and radio communications systems, and all seemed to be working without fault. Trouble struck on the thirteenth day of flight, on April 15, on the 188th orbit of *Salyut 2*. Controllers reported that the main telemetry system had failed; according to "support" telemetry, pressure in the main hull had dropped by half, and precise measurements of the station's orbital trajectory showed that its path had deviated slightly, as if given some kind of thrust. Clearly, some type of catastrophic failure had occurred on the station, squelching the possibility that any crew would be heading in its direction any time soon. Early the next morning, the senior members of the State Commission, including Col. General Grigoryev and Space Assets Commander Lt. General Karas, met at Chelomey's offices to discuss the situation. An accident investigation commission under Karas was established. Throughout the next few days, engineers pored over ground models of Almaz to ascertain the cause of this sudden event by simulating various

30 Polyachenko, "The 'Pep' of Almaz."

31 Chugunova, "Chelomey's Cosmonauts "

32 Roald Z. Sagdeev, *The Making of a Soviet Scientist: My Adventures in Nuclear Fusion and Space From Stalin to Star Wars* (New York: John Wiley & Sons, 1994), p. 207.

33 Kenneth Gatland, *Manned Spacecraft* (New York: Macmillan, 1976), p. 234.

conditions. Specialists also flew to Yevpatoriya to look into the matter. The initial prognosis was that there might have been some ground error, but this hypothesis was eliminated when investigators ascertained that each command transmitted to Salyut 2 had been without fault.³⁴ On April 18, unofficial Soviet sources in Moscow denied that piloted visits had ever been planned for Salyut 2. On April 28, the Soviet news agency TASS announced that *Salyut 2*, "having checked the design of improved on-board systems and carried out experiments in space, had completed its flight program." notably omitting the word "successfully," which it normally used in such press releases."

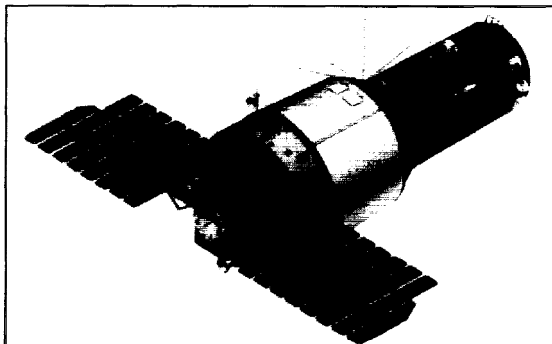

This drawing shows the flight variant of the Almaz space station with its unique docking node visible on the left. The viewport for the Agat-1 reconnaissance camera was located on "the underside" of the vehicle, not visible in this image (copyright VideoCosmos Co., via Dennis Newkirk)

The Karas Commission arrived at the conclusion that there had been a manufacturing flaw in the main engine of the Almaz station, which, when fired, had caused punctures in the main hull.³⁶ One cosmonaut who trained for Almaz later recalled that there had been "an electrical fault in one of the station's devices which had eventually caused the rupture of the external hull."³⁷ Western reports, presumably filtered through to the open media from classified sources, suggested that the actual hull breach had been so violent that the station's solar panels and boom-mounted rendezvous radar and radio transponder had been ripped off, leaving *Salyut 2* tumbling in space. The engine, these reports suggested, could not be turned off once it was turned on.³⁸ Some of the station's designers begged to differ with the verdict of a malfunctioning engine, and there was apparently never any unanimity with the verdict. For example, an in-house investigation at Chelomey's design bureau concluded that the station might have been hit by residual debris from the Proton booster on April 15.³⁹ Perhaps the most curious claim advanced for the failure—a claim no doubt proposed to exonerate its designers of any fault—was that a meteorite had hit the station and blown a hole in its hull. Chelomey himself was said to subscribe to this opinion.⁴⁰ April was a bad month for the general designer. On April 25, one of his radar ocean reconnaissance satellites, the US-A, failed to reach orbit, depositing its nuclear isotope payload in the Pacific Ocean. U.S. Air Force planes apparently flew high above

34 Vladimir Polyachenko "The Pep of Almaz Part II" (English title) *Krylya rodiny* no 4 (April 1992) 30-32 B A Pokrovskiy *Kosmos nachinayetsya na zemlye* (Moscow Patriot 1996) pp 411-12

35 Gatland, *Manned Spacecraft* p 234 *Soviet Space Programs 1976-80 (With Supplementary Data Through 1983)* Manned Space Programs and Space Life Sciences prepared for the Committee on Commerce Science and Transportation U S Senate 98th Congress 2d sess (Washington DC US Government Printing Office October 1984) 547-48

36 Polyachenko "The Pep of Almaz Part II" Afanasyev 'Unknown Spacecraft'

37 Neville Kidger "Almaz: A Diamond out of Darkness" *Spaceflight* 36 (March 1994) 86-89

38 Thomas O Toole 'Soviet Union Still Trails U S in Space' *Washington Post* June 17 1973 pp A1 A8 *Soviet Space Programs 1976-80* p 548

39 Pokrovskiy *Kosmos nachinayetsya na zemlye* p 412

40 Sagdeev *The Making of a Soviet Scientist* pp 176 207-08 To confuse matters further, Chief Designer Mishin has claimed that the failure was caused by a malfunction in the attitude control system of Almaz See V P Mishin "Why Didn't We Fly to the Moon?" (English title) *Znaniye tekhnike seriya kosmonavtika astronomiya* no 12 (December 1990) 3-43

the Pacific to sample the upper atmosphere for radiation from the accident." Meanwhile, *Salyut 2*, lost and tumbling in space, eventually decayed from orbit on May 28, 1973. Popovich and the remaining cosmonauts training for their long-awaited flight would have to wait longer. Chelomey did not expect to have the next Almaz station ready for flight before, at least, the end of the year.

With Almaz out of the picture, things were desperate for the 1973 version of a space public relations offensive. The Skylab launch was imminent. On February 14, NASA's Manned Space Flight Management Council met and set May 14 as the launch date for the huge space station.⁴¹ Acutely conscious of the U.S. schedule, TskBEM engineers accelerated the preparations for the next DOS, no doubt under severe pressure from Brezhnev and Ustinov. The station had arrived at Tyura-Tam for final preflight testing in December 1972, and by late April 1973, State Commission Chairman Kerimov set May 8 as the launch date. This would be just six days prior to the Skylab launch. Troubles during prelaunch operations, however, threatened to thwart the Soviet plans. Engineers detected a depressurization in one of the propellant valves in the Proton launch vehicle, resulting in a major fuel leak. As personnel from the Khrunichev Plant began repairs, Chief Designer Mishin, under stress and being "emotional," refused to have his station launched by this particular Proton rocket, booster no. 284-01, even if the repairs were successful. Mishin, perhaps remembering the July 1972 DOS launch failure, remained characteristically stubborn, and he refused to budge from his position despite insistent arguments from other members of the State Commission. It was only through the intervention of other senior officials from TskBEM that Mishin conceded.⁴² The delays with the propellant leak pushed the launch back to May 11. The first crew, cosmonauts Leonov and Kubasov, would lift off three days later, the same day Skylab was slated to reach orbit.

Officers of the Strategic Missile Forces successfully launched DOS-3 on May 11, 1973, at 0320 hours Moscow Time. Initial orbital parameters were 218 by 266 kilometers at a 51.6-degree inclination. The spate of troubles with the Soviet space station continued with DOS-3. Kerimov recalled many years later that "suddenly, on the very first orbit, on a segment in which our control points did not control the operation of the spacecraft, the attitude-control rockets began working irregularly. As a result, all the fuel reserves were burning up."⁴³ Later analysis showed that the attitude control engines had spuriously begun firing because of a failure in an ion sensor. As telemetry continued to stream into Yevpatoriya on the situation, one controller exclaimed in horror, "The tanks are almost empty!"⁴⁴ Representatives from TskBEM were, evidently, slow to react and were unwilling to believe the telemetry. One engineer, Yevgeniy V. Bashkin, explained that such a quick consumption of propellant was impossible: it was 1,500 times faster than what was maximally possible. When subsequent telemetry confirmed rapid propellant loss, TskBEM Deputy Chief Designer Yakov I. Tregub, the flight director from the design bureau, finally accepted the initial conclusion. Unfortunately, by this time, little would have been accomplished by turning off the orientation system because all of the station's attitude control propellant was depleted. The possibility of crewing the station was effectively eliminated. The fact that the failure was detected in the first few orbits allowed the Soviet press to disguise the mission by calling it by the next number in the Kosmos satellite series, *Kosmos-557*, instead of using the *Salyut* name.

41. Thomas O'Toole, "2nd Russian Space Shot Fails." *Washington Post*, May 4, 1973, p. A1; "Soviet Space Attempt on April 25," *Space Daily*, May 8, 1973, p. 46. Note that both these articles incorrectly identified both the launch vehicle (the Proton) and the payload (Lunokhod). The actual launch vehicle was a Tsiklon-2 booster.

42. David Baker, *The History of Manned Spaceflight* (New York: Crown Publishers, 1985), p. 463.

43. Semenov, ed., *Raketno-Kosmicheskaya Korporatsiya*, p. 272.

44. V. Ovcharov and L. Chernenko, "Recommended by Korolev" (English title), *Sovetskaya Rossiya*, August 22, 1987, p. 2.

45. Pokrovskiy, *Kosmos nachinayetsya na zemlye*, p. 410.

An interdepartmental commission under Vyacheslav M. Kovtunenkov, a Deputy Chief Designer at KB Yuzhnoye, was established to investigate the Kosmos-557 failure and recommend compensatory measures. KGB representatives apparently participated in the deliberations, perhaps suspecting sabotage. The commission eventually found that the failure could have been averted if the flight control team had reacted faster. In the end, members prepared a plan to deorbit the station safely from orbit to preclude it from burning up over populated areas of Earth.⁴⁶ After a careful series of commands to the station, Kosmos-557's main engine was fired on May 22, 1973, to raise its orbit, but because of improper orientation, the spacecraft reentered the atmosphere and burned up over the Indian Ocean.⁴⁷ The repercussions of the accident were wider than simply the loss of a station. TskBEM Deputy Chief Designer Tregub was dismissed from his post as the flight director of all subsequent piloted missions and fired from the design bureau. Department Chief Raushenbakh was demoted to the position of a "consultant," and he left TskBEM soon after. There were apparently others who lost their jobs. It was the first time that such dismissals had taken place in the piloted space program, despite the earlier deaths of the Soyuz 1 and Soyuz 11 crews.⁴⁸

In the official history of TskBEM, the episode with the loss of DOS-3 is described as "a big blow to the program."⁴⁹ The timing of the Almaz and DOS losses in the spring of 1973 could not have been worse. NASA launched Skylab 1, the first American space station, into orbit on May 14, 1973. NASA, of course, had its own problems with Skylab. During launch, the meteoroid shield tore off, causing one of the solar panels to be ripped off and the other one to be jammed in an inert position. But the remarkable resourcefulness of NASA engineers and astronauts was demonstrated amply in late May, when three astronauts docked with the station and revived it to almost full capacity. On June 22, 1973, they returned to Earth after a twenty-eight-day flight, regaining once more the absolute endurance record in space for the United States.⁵⁰ Now the Soviet Union was lagging behind the United States in both the lunar landing and space station areas of piloted space exploration. Another reason for the ill-timing was the acceleration of work on the Apollo-Soyuz Experimental Program, better known in the West as the Apollo-Soyuz Test Project. Although there had been nary a word on both the *Salyut 2* and Kosmos-557 failures from the Soviet press, there was much speculation in the Western press on these two missions. Official representatives from the Soviet side were no doubt embarrassed by this attention. In October 1973, Academician Boris N. Petrov, one of the "figurehead" leaders of the Soviets, told NASA's George M. Low that "there had been no plans to send men to occupy" *Salyut 2*.⁵¹ In another outright lie, he added that the flight of Kosmos-557 had not been related to the piloted space program.

The Light at the End of the Tunnel

The loss of both *Salyut 2* and Kosmos-557 meant there would be no Soviet space station missions during the remainder of 1973. Crews for both the Almaz and DOS programs would have to wait much longer to carry out their long-delayed space station flights. One particular crew,

46 *Ibid* pp 410-11

47 Afanasyev 'Unknown Spacecraft'

48 Semenov ed *Raketno Kosmicheskaya Korporatsiya* pp 273-355 Pokrovskiy *Kosmos nachinayetsya na zemlye* p 411 Tregub was replaced by TskBEM Deputy Chief Designer B. Ye. Chertok and Raushenbakh was replaced by V. P. Legostayev

49 Semenov ed *Raketno Kosmicheskaya Korporatsiya* p 273

50 Linda Neuman Ezell *NASA Historical Data Book Volume 111 Programs and Projects 1969-1978* (Washington D.C. NASA Special Publication (SP) 4012 1988) p 104

51 Edward Clinton Ezell and Linda Neumann Ezell *The Partnership A History of the Apollo Soyuz Test Project* (Washington DC NASA SP 4209 1978) p 232

cosmonauts Leonov and Kubasov, had perhaps the most trying experience in their arduous training program for the DOS. In June 1971, they had trained to fly the first *Salyut*. DOS-1, only to be dropped days before the launch because of Kubasov's illness. They would have flown the second mission to the station in July, had it not been for the deaths of the Soyuz 11 crew. In July 1972, they were ready to fly to the DOS-2 station when it exploded in air before ever reaching orbit. Then, for the fourth and final time, they were days from flying to DOS-3 in May 1973 before the fatal attitude control system failure destroyed that hope. After three years of training for DOS missions. on May 25, 1973, just days after the Kosmos-557 failure. Soviet officials announced that Leonov and Kubasov would be the primary crew for the Soviet side of the Apollo-Soyuz Experimental Program." Naturally, there was no word on their activities of the past few years.

Having no space station to which to go meant there was the possibility of an even longer hiatus in Soviet piloted spaceflights. To take advantage of the gap, Mishin drew up a plan to thoroughly test the new 7K-T Soyuz ferry variant on an independent flight. In addition, he inserted a second solo Soyuz mission, which would carry out some of the astrophysics experiments they had been forced to abandon because of the loss of two consecutive DOS space-ships. In July 1973, crews began training for these two missions.⁵³

As a prelude to these two missions. TsKBEM inserted a third solo Soyuz mission—an automated flight to verify all the new design changes on the vehicle that had been introduced in 1972–73. That Mishin did not fly such a robot flight prior to the May 1973 space station attempts indicates that those missions were under time pressure to get off before Skylab. Having lost the battle over space stations, there was no incentive not to fly a precursor mission anymore. Soyuz 7K-T spacecraft no. 35 lifted off without incident at 0900 hours Moscow Time on June 15, 1973. into an initial orbit of 209 by 268 kilometers at a 51.55-degree inclination. During its two-day, nine-minute flight, the 6,790-kilogram spacecraft, named Kosmos-573 in the Soviet press. performed a single orbital maneuver to lower apogee before returning to Earth on June 17. Presumably, the first flight of the "solar panel-less" Soyuz variant was sufficiently successful to warrant dedicated preparations for a "return-to-flight" mission in the program.

It had been more than two years since a single Soviet cosmonaut had been in space. The honor to break this dubious record fell on the shoulders of two seasoned veterans of the cosmonaut corps, neither of whom had ever flown in space before. At age forty-five. Commander Lt. Colonel Vasilii G. Lazarev's involvement in the space program dated back to the early 1960s, when he had taken part in the *Volga* high-altitude balloon flights to test prototype pressure suits, during which pilots parachuted from altitudes as high as thirty-two kilometers. Later, in 1964, he had been considered a prime contender to fly the historic three-cosmonaut Voskhod flight. It was only at the last minute, after insistent opposition from the late Korolev, that another candidate replaced him on the primary crew. An Air Force doctor by profession, he had "officially" joined the cosmonaut team on January 17, 1966, just days after Korolev's death.⁵⁴ Flight Engineer Oleg G. Makarov, at age forty, was an old-timer from TsKBEM

52. K. Lantratov. "Do You Remember How All This Began? (20 Years From the Docking of 'Soyuz' and 'Apollo')" (English title). *Novostr kosmonavtikr* 15 (July 16–29, 1995). 42–52.

53. Lantratov. "20 Years From the Flight of 'Soyuz-12': E-mail correspondence. Sergey Voevodin to the author, January 30, 1997. Crews for the first mission were V. C. Lazarev/O. G. Makarov. A. A. Gubarev/G. M. Crechko, and P. I. Klimuk/V. I. Sevastyanov. Crews for the second mission were L. V. Vorobev/V. A. Yazdovskiy. P. I. Klimuk/Yu. A. Ponomarev, and V. V. Kovalenok/V. I. Sevastyanov.

54. Lazarev had actually replaced a new cosmonaut candidate V. A. Degtyarev, who resigned on the same day that Lazarev joined. See V. Semenov, I. Marinin, and S. Sharnsutdinov. *Iz istorii kosmonavtikr uypusk I. nabory v otryady kosmonavtov i astronautov* (Moscow. AO Vrdeokosmos. 1995). pp. 10, 12; Rex Hall. "Soviet Air Force Cosmonauts." in Michael Cassutt, ed., *Who's Who in Space. The International Space Year Edition* (New York: Macmillan, 1992). pp. 245–46.

who had worked on the development of the Vostok, Voskhod, and Soyuz spacecraft. He joined the cosmonaut team as part of the first civilian engineer intake on May 23, 1966. Later, Makarov had actively trained as one of the primary contenders for the first L1 circumlunar and L3 lunar landing missions, before finally moving to train for the Kontakt project in April 1970. When that effort was also canceled in September 1971, he began training for DOS space station flights.⁵⁵

The launch of 7K-T Soyuz spacecraft no. 36 took place at 1518 hours Moscow Time on September 27, 1973. On board were Commander Lazarev and Flight Engineer Makarov. The spaceship, openly named Soyuz 12, entered an initial orbit of 193 by 248.6 kilometers at a 51.61-degree inclination. Within seven hours of launch, the cosmonauts fired the Soyuz main engine to alter their orbital parameters to 326 by 345 kilometers, similar to the apogees of the earlier Kosmos-496 and Kosmos-573, both automated precursors to the Soyuz station "ferry version." The crew seemed to have been simulating the first portion of a rendezvous profile with an imaginary station. Perhaps to preclude rumors of a failed mission, the Soviet press announced publicly during the first day of flight that the Soyuz 12 mission would last only two days, sufficient to test its capabilities as a crew transport ship to the DOS.⁵⁶

Events were evidently normal during the first day of flight. Few scientific experiments were included in the program. The most prominent one announced was the use of the nine-objective LKSA multispectral camera developed by Moscow State University. Makarov took Earth resources photographs using the hand-held camera, while Lazarev simultaneously took photographs of the same targets using a standard camera. Other experimenters in airplanes took photographs of the same areas to compare distortions introduced by the atmosphere. Small biological payloads were apparently carried aboard Soyuz 12, although the Soviet press did not release any details. Contact with the ground was maintained by the ship *Akademik Sergey Korolev*, stationed in the Atlantic, and by a Molniya-1 communications satellite.⁵⁷

One of the primary goals of the flight was to test the Sokol-K1 pressure suits. At some point during the mission, Lazarev and Makarov depressurized part of their ship to test these suits. On the second day, however, there were "serious defects" in the life support system, followed by a failure in the ship's attitude control system.⁵⁸ Soon afterwards, the cosmonauts wrapped up their activities and successfully returned to Earth wearing their new suits, landing at 1434 hours Moscow Time on September 29, after a one-day, twenty-three-hour, fifteen-minute, and thirty-two-second flight. There was a curious postscript to the flight. Both cosmonauts had candidly and bluntly written about the problems during the mission in their on-board journals. When the State Commission examined their comments, officials reportedly tried to "muffle" their complaints, calling the flight a closed subject. For a time, the cosmonauts were unsure whether their reports would affect their future careers, but soon both were assigned to another flight.⁵⁹

The Soyuz 12 mission may not have been an unequivocal success, but the flight did serve to instill some confidence in the space program. It was the first Soviet piloted mission in more than three years that had fully achieved its objectives. The flight was followed in quick succession by two more launches of the 7K-T ship before the end of the year. The first of these was the flight of vehicle no. 34L to simulate a full two-month stay in orbit. Launched at 0820 hours Moscow

55 Semenov Marinin and Shamsutdinov *Iz istorii kosmonautiki vypusk 1* p 13 Voevodin correspondence January 30 1997

56 Peter Smolders *Soviets in Space* (New York Taplinger Publishing Co. 1973) p 250

57 *Ibid* Gatland *Manned Spacecraft* p 237 Christian Lardier, *L'Astronautique Soviétique* (Paris Armand Colin 1992) p 191 *Soviet Space Programs 1976-80* p 518

58 Rebrov *Kosmicheskiye katastrofy* p 73 Lantratov "20 Years From the Flight of Soyuz 12"

59 Rebrov *Kosmicheskiye katastrofy* pp 73-74

Time on November 30, 1973, the spacecraft was disguised under the designation Kosmos-613. Initial orbital parameters were 195 by 295 kilometers at a 51.6-degree inclination. Few details have been released on the flight. Over a period of six days, the spacecraft maneuvered into a "working orbit," similar to ones planned for future DOS missions, and then powered down, simulating conditions when such ferries would be docked to a space station. After an apparently successful sixty-day, nine-minute mission, Kosmos-613 returned to Earth successfully on January 29, 1974.

The final Soyuz flight in 1973 was a piloted mission, launched primarily to perform scientific experiments that had been delayed because of the repeated failures in the DOS program. The main payload on the Soyuz ship was the Orion-2 astrophysical telescope designed by Dr. Grigor Gurzut, a Corresponding Member of the Armenian Academy of Sciences. The instrument, designed to observe stars in the ultraviolet band of the electromagnetic spectrum, was installed in place of the deleted large docking apparatus at the forward end of the spaceship. In addition, the living compartment of the vehicle was transformed from the normal living quarters into a dedicated scientific laboratory, and the spacecraft was equipped with solar panels. The mission itself was timed to coincide with Comet Kohoutek's approach to Earth in late 1973. Since July 1973, the primary crewmembers for the mission were cosmonauts Lt Colonel Lev V. Vorobyev and Valeriy A. Yazdovskiy. The former, a forty-two-year-old Air Force pilot, had almost been victim to political intrigue in the 1960s. Having joined the cosmonaut corps on January 10, 1963, as one of a new batch of trainees who would fly to the Moon, Vorobyev immediately got into hot water when, in early 1964, he and another trainee, Eduard P. Kugno, publicly criticized the Communist Party. When asked to make a speech in front of a local Party meeting, Kugno had evidently told a senior Party official, "I will not speak to a Party of swindlers and sycophants!"⁶⁰ He was expelled from the cosmonaut team on April 16, 1964. Vorobyev survived the "purge" because he was already a member of the Communist Party. He eventually went on to train for the Almaz and Kontakt programs.

Civilian engineer Yazdovskiy, forty-three years old, played an important role in drawing up the experiments program for the Orion-2 mission. He joined TsKBEM during the Korolev era in 1957 and was a part of the teams that designed the Vostok, Voskhod, and Soyuz spacecraft. Like Vorobyev, this would be his first spaceflight, although he had served in backup capacities. Unfortunately for both, the two had an extremely difficult time getting along with each other. At one point during the training, they even refused to sit at the same table during a lunch break, preferring to sit on opposite sides of the lunch room. A month before the scheduled launch, cosmonaut overseer Lt. General Shatalov had no choice but to remove the two men from the flight and substitute the backup crew into the primary spot."

The two new cosmonauts—thirty-one-year-old Major Petr I. Klimuk (commander) and thirty-one-year-old civilian Valentin V. Lebedev (flight engineer)—lifted off in 7K-T spacecraft no. 33 at 1455 hours Moscow Time on December 18, 1973. The vehicle, named Soyuz 13 in the Soviet press, entered an initial orbit of 193.3 by 272.7 kilometers at a 51.6-degree inclination. Both cosmonauts, like the original primary crewmembers, were rookies. Klimuk, something of a child prodigy, was the first of his batch of cosmonauts, selected on October 28, 1965, to make a spaceflight. He trained for many years in the L1 and L3 lunar programs before his assignment to the current mission. Lebedev was a civilian engineer from TsKBEM who had joined the cosmonaut team on March 22, 1972, just over a year prior to the flight. It was one of the shortest times from selection to flight in the history of the Soviet space program. Both

60 N. P. Kamanin, *Skrytyi kosmos kniga utaraya 1964-1966gg* (Moscow, Infortekst IF, 1997), pp. 26-40. Hall, "Soviet Air Force Cosmonauts," p. 244. 272: V. Molchanov, "Disgraced Cosmonaut" (English title) *Apogey* 2 (January 1993) 4. Kugno was officially dismissed on June 17, 1964.

61. Hall, "Soviet Air Force Cosmonauts," p. 316.

men had trained extensively at the Byurakan Observatory in Armenia where the Orion-2 telescope had been built. As soon as the two cosmonauts entered orbit, it marked the first time in the history of spaceflight that men from both the United States and the Soviet Union were in space at the same time. NASA astronauts were then in the middle of their marathon Skylab 4 mission. By Soyuz 13's fifth orbit, the cosmonauts had performed a series of orbital maneuvers, depositing their ship in a 225- by 272-kilometer orbit at 51.6 degrees.⁶²

During the course of their immensely successful flight, Klimuk and Lebedev performed a wide range of scientific experiments in the fields of medicine, biology, Earth resources, astronomy, and navigation. Medical experiments included one called *Leukoy-3* to investigate the circulation of blood to the brain in microgravity. The main biological experiment centered around the use of the *Oazis-2* unit used for research into protein mass in space, which the cosmonauts activated on their second day in orbit. In the experiment, the waste products of one type of bacteria served as the initial material used by other bacteria to accumulate protein mass. During the Soyuz 13 mission, this regenerative process increased the biomass by thirty-five times, an encouraging sign for those attempting to design a closed-cycle life support system. Plants used in the experiment included chlorella and duckweed.

The Earth observation experiments included use of the RSS-2 spectrograph for photographing the day and twilight horizons. The cosmonauts also used a nine-lens camera with different color filters to expose three strips simultaneously to Earth's surface. Two of the films were sensitive to visible light and the third to infrared light. Navigational exercises consisted of activities in autonomous navigation to determine the accuracy of control systems. The primary goal of the mission was the use of the Orion-2 telescope. Unlike Orion-1 on the *Salyut* station, Orion-2 was mounted completely outside the spacecraft. The telescope was mounted on a three-axis stabilized platform with a pointing accuracy of two to three seconds of arc. The pointing was performed both by moving the ship and the telescope, using thirteen electric motors. The Orion-2 telescope complex also included an instrument for studying x-ray emissions from the Sun—the crew performed such experiments on the third day during the sixty-fifth orbit concurrent with Earth-based observations. During the Soyuz 13 mission, the crew took 10,000 spectrograms of more than 3,000 stars in the constellations of Taurus, Orion, Gemini, Auriga, and Perseus. All the spectrograms, using NASA-supplied film, were in the spectral classes of 2,000–3,000 Angstrom units, which cannot be studied from Earth."

The two men successfully returned to Earth after a seven-day, twenty-hour, fifty-five-minute, and thirty-five-second mission, landing at 1150 hours Moscow Time on December 26, 1973. The flight was an unqualified success—an encouraging sign that Mishin and his engineers had bounced out of the dismal dregs of the past few years. In retrospect, the Soyuz 12 and Soyuz 13 missions came at a particularly important juncture in the history of the Soviet space program. For the first time in many years, consecutive piloted missions had instilled hope instead of despair. Clearly, both of these flights had modest objectives, but for years, the Soviets had difficulty in achieving even modest goals in space. After years of doubt, it also seemed that engineers had managed to eliminate all the bugs from the troubled Soyuz spacecraft. Finally, in what no one could guess at the time, the mission was the very final piloted mission under Mishin's command. An era was about to end.

The Saga Continues . . . Barely

The third NI failure, on June 27, 1971, occurred three days before the deaths of Soyuz 11 cosmonauts Dobrovolskiy, Volkov, and Patsayev. One can only imagine the spirits of those

62. Soviet Space Programs 1976–80, p. 518

63. *Ibid.*, pp. 520–21; Gatland, *Manned Spacecraft*, pp. 238–39

engineers who had to peruse through all the debris and telemetry of the NI accident in the late summer of 1971. The obligatory accident commission met several times throughout July and August to determine the cause of the explosion of booster no. 6L. By October 15, Academician Keldysh had signed the final conclusion of the commission on the causes of the accident.

During the launch, all the engines worked normally for the first time after ignition, but roll stabilization of the rocket was not nominal. The roll error gradually increased and was at fourteen degrees by T+14.5 seconds—that is, the rocket had turned fourteen degrees around its main axis despite the counteraction of vernier nozzles to correct the roll. In fact, by T+7.5 seconds (at an altitude of 250 meters), the verniers had hit their mechanical stops (at forty-five degrees), unable to turn anymore. Furthermore, at T+39 seconds, the gyro instruments of the NI terminated operation, and for the remainder of the flight, the rocket was not stabilized along its axes. At T+47.8 seconds, the booster began to break up in the area between the third stage and the L3 payload. The latter separated from the main body of the rocket and fell not far from the launch pad, while the "beheaded" rocket continued to fly. Finally, at T+50.1 seconds, when the uncontrolled roll had reached 200 degrees, the KORD system switched all the first stage engines off as a result of an emergency command from the limit switches of the gyro instruments. NI Chief Designer Boris A. Dorofeyev later described why the roll error had occurred:

The 61 vehicle lost roll control due to a design error. The designers misjudged the air pressure signature in the bottom part of the rocket in flight. They also misjudged the influence of the pyrotechnical starter exhaust tubes, which were located asymmetricaly on each of the 30 engines. The shape of the rocket's bottom and two rings of closely-installed engines created two zones of air depression behind the booster. The asymmetrical location of the exhaust tubes created a high-torque rotating force on the borders of those depression zones. The six control thrusters were unable to compensate for that force. That effect did not take place on the first two launches because not all the engines worked at that time. The non-working engines of the outer rings created "air gaps," wide enough to diminish the depression zones' effect.⁶⁴

The third failure of the NI evidently raised the possibility of terminating the rocket program completely. Yuriy A. Mozzhorin, the influential Director of the Central Scientific-Research Institute of Machine Building (TsNII Mash), recalled that there was a meeting of the Military-Industrial Commission on the issue after the third NI failure. He explained later:

... when the question of shutting the project down was being decided, I came out against it. Why? By that time, we had acquired the experience, many of the engineering objectives had already been achieved, and we had the ability to expose the weak points. . . .⁶⁵

Despite the third failure, confidence was, in fact, growing among the rocket's leading engineers that they were close to success. The next booster, no. 7L, would be a significantly improved model, while the following one, no. 8L, was an altogether different variety with completely new multifiring engines on the first three stages, as well as highly optimized systems.

64 R. Dolgopyatov, B. Dorofeyev, and S. Kryukov. "At the Readers' Request. The NI Project" (English title). *Aviatsiya i kosmonavtika* no. 9 (September 1992): 34–37. Igor Afanasyev. "NI: Absolutely Secret" (English title). *Krylya rodny* no. 11 (November 1993): 4–5.

65 Boris Arkadyevich Dorofeyev. "History of the Development of the NI-L3 Moon Program." presented at the 10th International Symposium on the History of Astronautics and Aeronautics. Moscow State University, Moscow, Russia. June 20–27, 1995.

66 Col M. Rebrov. "A Portrait in the Light of Glasnost: A Call After Midnight" (English title). *Krasnaya zvezda*. December 1, 1990, p. 4.

The extensive changes on booster no. 7L were crucial for achieving orbit. Many of these alterations were performed not only to improve chances for a success, but also to increase the mass of the payload itself. Designers had improved the aerodynamic characteristics of the first stage by reducing the area of the bottom of the first stage by replacing part of the lower conical skirt with a cylindrical section, thus reducing the base diameter from 16.9 to 15.8 meters. They also introduced tapered fairings to replace the rounded ones, improved the NI's thermal protection characteristics, and optimized the thermal insulation of the propellant tanks. Flight control would be performed by an on-board computer from commands issued by a gyro-stabilized platform developed by Chief Designer Pilyugin's Scientific-Research Institute for Automation and Instrument Building. To improve roll control, engineers introduced four 11D121 vernier liquid-propellant rocket engines, developed under Deputy Chief Designer Mikhail V. Melnikov, to replace the six old exhaust nozzles on the first and second stages. The rocket would also have the Freon passive fire extinguisher system as well as new mechanical and thermal protection for instrumentation and the on-board cable system. Finally, the telemetry measurement systems had been modified, by the Experimental Design Bureau of the Moscow Power Institute under Chief Designer Bogomolov, with the use of miniature radio-telemetry gear. The new system made it possible to receive information from approximately 700 newly mounted sensors, making a total of 13,000 sensors on the booster."

With respect to the problems of the main engines of the first three stages, one of the most irksome was the burn-throughs of the internal propellant lines, especially of the LOX lines, caused by the design choice of having the engines' components very close together to reduce tubing length. The NI State Commission, having investigated the matter, concluded on January 1, 1972, that this problem had finally been eliminated." The engines on 7L also had aerodynamic shields on their exterior to protect them from high-velocity air streams. Meanwhile, Kuznetsov's new engines, capable of being refired, and with very high-performance characteristics, underwent ground testing from 1971 through 1972. Engineers completed the interdepartmental tests of the NK-33 (first-stage) and the NK-43 (second-stage) engines in September 1972.⁶⁷ Mishin's original planning from the 1970 period was to use the new engines beginning with NI booster no. 81, contingent on a schedule in which ground testing of the new engines would finish in time for installation on booster no. 8L. Not surprisingly, there were delays in preparing for the next NI launch; booster 7L's launch was set for the fourth quarter of 1972, by which time Kuznetsov's new engines were ready for flight. The natural question was: what point was there in launching the NI with old engines when the new engines were ready? Senior designers in the program recalled later that:

... certain ministry heads were of the opinion that [booster no. 71 with the older engines] should be mothballed. But such a decision would *have* led to a further delay in the creation of the launch vehicle of at least two and a half years. And while the new engines were being manufactured and stand tests of the sections were being performed, the launch of rocket no. 7 could be used to check out the dynamics of the flight control

67. Dolgopyatov, Dorofeyev, and Kryukov, "At the Readers' Request. The NI Project". Afanasyev, "NI Absolutely Secret". Semenov, ed. *Raketno Kosmicheskaya Korporatsiya*, p. 258; I. A. Marinin and S. Kh. Shamsutdinov, "Soviet Programs for Piloted Flight to the Moon" (English title). *Zemlya i vseennaya* no. 5 (September-October 1993) 77-85. Alexander Yasinsky, "The N-I Rocket Programme." *Spaceflight* 35 (July 1993) 228-29.

68. N. I. Panichkin, "Some Results of NI Development with Multi-Engine Powerplants." presented at the 10th International Symposium on the History of Astronautics and Aeronautics.

69. Dolgopyatov, Dorofeyev, and Kryukov, "At the Readers' Request. The NI Project." Tests for the third-stage engines (NK-39) were completed by November 1973.

with the new vernier engines and the essentially new control system, as well as check out many other designs. After a number of discussions, the State Commission decided to go through with the launch [of 71 using the old engines]."

In August 1971, the Keldysh Commission had effectively terminated the L3 program with the recommendation that further work on the Lunar Orbital Ship (LOK) and Lunar Ship (LK) cease in favor of more capable lunar spaceships. The official decision to close down further production of L3 components was apparently issued in a September 1972 governmental decree on the NI-L3 program.⁷⁰ At the time of that order, there were several fully built models of both the LOK and the LK at the TsKBEM plant. Some of these would fly the remaining NI-L3 launches, performing automated and piloted flights to the Moon. The payload for booster no. 7L was the first flightworthy model of the LOK, vehicle no. 6A, and a mock-up of the LK lander installed underneath the L3 payload fairing. Quite possibly, the total lifting capability of booster no. 7L was not sufficient to carry both a functional LOK and an LK.

The flight plan for booster 7L was signed on July 18, 1972, by Mishin and his three principal Deputy Chief Designers—Okhapkin, Chertok, and Tregub. The plan detailed a complete lunar-orbital mission for the LOK from launch to landing. The NI was to lift off from site 110L with a 89,803-kilogram L3 payload consisting of the Blok G fourth stage, the Blok D fifth stage, the LK mock-up, the LOK, and associated fairing. The nominal orbit would be 200 by 740 kilometers at a 50.7-degree inclination. If all operations were within acceptable parameters, the L3 complex would circle Earth for a period of twenty-four hours, with translunar injection taking place by firing the Blok G stage on the sixteenth or seventeenth orbit. Once the Blok G tanks were empty, the stage would cease firing and ignite the Blok D stage for a period of forty-four seconds to impart sufficient escape velocity to the payload. There were contingencies to go for translunar injection on the eighteenth or nineteenth orbits if the earlier attempt failed. In case of a complete failure to escape Earth's orbit, the LOK would simply separate from the stack, carry out a thorough testing flight in Earth orbit, and splash down in the Indian Ocean.

The LOK-LK-Blok D complex would spend just over four days in transit to the Moon, during which the Blok D would fire twice for mid-course corrections—the first at eight to ten hours after launch and the second ten to twenty-four hours prior to achieving lunar orbit. For most of this period, the stack would be in a slow roll mode of a half degree per second, accelerating during one period to two degrees per second to ensure proper thermal equilibrium in Blok D. At T+98.5 hours, the stack would enter lunar orbit. The initial and transitional lunar orbits were selected to ensure the best conditions for surface photography during the mission of booster no. 7L. The initial orbit would be near circular at 175 plus or minus seven and a half kilometers, while the later orbit would be elliptical with a perilune of forty plus or minus five kilometers. Both orbits would have inclinations to the lunar equator of 180 degrees plus or minus two degrees. Corrections to the orbit were to take place on the fifth and twenty-seventh orbits.

During the LOK's time in lunar orbit, special cameras were to take detailed photographs of the selected landing sites on the fourteenth, seventeenth, thirty-fourth, and thirty-sixth orbits. The LOK would separate from the LK mock-up and Blok D after a command from Yevpatoriya subsequent to the completion of photography on the thirty-sixth orbit. The LOK's living compartment would also detach from the rest of the vehicle on the thirty-ninth orbit, followed three orbits later by a firing of the Blok I engine to impart sufficient velocity to send the spacecraft back to the direction of Earth. Total time in lunar orbit would be about 3.7 days.

70. *ibid.*, p. 36. One reliable source suggests that NI booster no. 7L used the old engines because the new engines were not ready for flight at the time. See Afanasyev, "NI: Absolutely Secret."

71. V. Pappo-Korystin, V. Platonov, and V. Pashchenko, *Dneprovskiy raketno-kosmicheskii tsentr* (Dnepropetrovsk: PO YuMZ/KBYu, 1994), p. 82. Semenov, ed., *Raketno-Kosmicheskaya Korporatsiya*, p. 574.

On the way back to Earth, the LOK would carry out two mid-course corrections—the first about a day after leaving lunar orbit and the second about six hours prior to approach into Earth's atmosphere. About eight minutes prior to entry into the atmosphere, the ship would separate into its remaining components, the descent apparatus and the instrument-aggregate compartment. The landing of the descent apparatus would be in the Indian Ocean after a flight from a northwesterly direction."

Throughout 1972, as this mission was being prepared, there were the occasional leaks in the Western press suggesting that the Soviets had resumed their piloted lunar landing program. One of the most precise predictions came from Charles S. Sheldon II, an analyst at the Library of Congress who distinguished himself by being one of the few Western observers who continued to strongly believe that the Soviet Union was still planning piloted lunar expeditions. Without knowing the details of the L3M program, Sheldon accurately exclaimed, "When they get that big booster back in shape, the Soviets will go to the Moon." He summarized his beliefs, confirmed twenty years later by Russian disclosures, by saying, "The Soviets are simply waiting to play one-upmanship with us when we have nothing going on in manned spaceflight." Rumors of the next N1 launch also filtered through. In September 1972, U.S. reconnaissance satellites evidently witnessed the N1 being taken back to the assembly-testing building at Tyura-Tam, thus spurring reports that no launch was imminent.⁷⁴ In fact, activity at Tyura-Tam was significantly accelerated in the waning months of 1972, primarily related to the fourth N1 launch attempt.

For the first time during an N1 launch, Chief Designer Mishin, in the hospital because of illness, was not present to direct technical operations. He assigned Deputy Chief Designer Chertok to serve as "technical director" of the State Commission." Minister Afanasyev, who served as the chair of the commission, was apparently unsure of whether to risk a completely flight-ready LOK on an N1 equipped with the old engines. In a last minute appeal to N1 Chief Designer Dorofeyev on launch day, he proposed replacing the expensive LOK with a mock-up. In the final analysis, Dorofeyev convinced the Afanasyev that it would be advantageous to have a real "live" ship on the rocket.⁷⁶

The fourth N1 lifted off at 0911 hours, 55 seconds Moscow Time on November 23, 1972. To observers, the flight seemed to be completely successful. Telemetry indicated that the engines were operating normally, and all parameters appeared normal. Passing the seventy-second mark, it was already flying longer than any of its predecessors. The six core engines shut down automatically at T+90 seconds, apparently without problems. It was only at T+104 seconds that the first sign of trouble appeared, but within the rapid seconds passing by, there was literally no chance to react. Within three seconds, a powerful explosion in the tail section of the first stage destroyed the lower portion of the spherical oxidizer tank. The booster exploded and broke up into pieces in the air. There had been just seven seconds left before first-stage shutdown and second-stage firing. This time, the difference between success and failure was measured in seconds. The emergency rescue system activated on cue and saved the LOK descent apparatus from virtual destruction."

72. E-mail correspondence. Vladimir Agapov by the author. September 30, 1996

73. Jack Haitsfield "Russians Seen Landing Crew on Moon in 1975." *Huntsville Times*. April 2, 1972. pp 17-18.

74. Richard D. Lyons, "Moon Shot Delay by Soviet Likely," *New York Times*, October 1, 1972, p. 51

75. Tarasov, "Missions in Dreams and Reality"

76. V. F. Gladkiy, "The Last Launch of the N1 Rocket" (English title). *Aviatsiya i kosmonavtika uchera. segodnya. zavtra* no. 8 (August 1997): 28-31

77. Afanasyev, "N1: Absolutely Secret"; Semenov, ed., *Raketno-Kosmicheskaya Korporatsiya*. p. 258

The investigation into the 7L failure, like the ones for the previous NI accidents, was long and arduous. The process, however, differed in one substantive way from the previous times: this time the investigation was bogged down in inter-design bureau rivalries and politics. At the initial hearing of the State Commission to discuss the accident, Chertok reported that preliminary data indicated that one of the engines on the periphery of the first stage had shut off spuriously before the destruction of the tail compartment. But engine Chief Designer Kuznetsov was reluctant to agree, believing that if the fault of the accident was placed on the shoulders of his design bureau, then Minister of Aviation Industries Petr V. Dementyev would shut down his entire operation—a threat that Dementyev had in fact hinted before the launch. In his defense, Kuznetsov argued that the NI had been destroyed because of design vibrations in the frame of the rocket as a result of the scheduled shutdown of the six central engines just before the explosion.

Afanasyev drew up a compromise solution in which the suspect engine had been destroyed because of the unexpected influence of oscillations in the rocket. Parties on both sides, however, refused to accept this version.⁷⁸ Kuznetsov eventually sharpened his version of the causes of the accident, suggesting that the failure had occurred as a result of an explosion in a pipeline leading to an engine—that is, not in the engine itself, but in the armature of the rocket. The engineers who wanted to exonerate the NI rocket gathered a formidable array of supporters to back their cause, including researchers from the Scientific-Research Institute of Thermal Processes (the former NII-1) and the Scientific-Research Institute of Measurement Technology (NII IT). Their combined investigation of sensor readings from the NI showed that a shock wave had passed through the booster's body as a result of the engine explosion. Kuznetsov argued back that the sensor readings were incorrect, but NII IT Director Oleg N. Shishkin persuasively showed through further investigation that all sensor readings were in fact completely reliable. Given the evidence up to this point, the State Commission accepted a provisional version that the accident had occurred because of a failure in the suspect engine and that Kuznetsov's assumption on depressurization of the oxygen pipeline before the explosion was not supported by sensor measurements.

The situation was complicated because TskBEM Chief Designer Mishin had very good personal relations with Kuznetsov. The former was clearly put in a difficult position; most of his subordinates were opposed to Kuznetsov's argument that the blame lay in the rocket rather than the engines. On Kuznetsov's personal request, Mishin agreed to have the matter investigated by the NI Council of Chief Designers—a body that did not include representatives from the dueling ministries. The central issue at hand was the reliability of the data from NI sensors. The council's findings were also not to Kuznetsov's liking, and he apparently scoured through their report trying to unsuccessfully find any fault in their logic. According to one witness, "he simply could not believe that [the engines] had blown up at the end of their resources. . . ."⁷⁹ Minister of Aviation Industries Dementyev, Kuznetsov's somewhat unsympathetic boss, then established an independent panel of aeronautics specialists to examine Kuznetsov's claim that the failure occurred as a result of a break in a 250-millimeter line that fed LOX to engine no. 4 on the first stage. The rupture, according to Kuznetsov, had been caused by "a water hammer" from the sudden cutoff of the six central engines of the NI, which turned off on schedule between eighty and ninety seconds after launch to reduce the g loads during injection and to save propellant. Dementyev's commission came to the same conclusion: that the engine cutoff had not led to the explosion."

78. The principal individuals on the TskBEM side were D. I. Kozlov (Deputy Chief Designer, TskBEM), B. A. Dorofeyev (NI Chief Designer, TskBEM), V. V. Simakin (Chref, NI Design Complex, TskBEM), and A. S. Kirillov (Chief, Chief Directorate, MOM). See Gladkiy, "The Last Launch of the NI Rocket."

79. *Ibid.*, p. 29.

80. *Ibid.*, Afanasyev, "NI: Absolutely Secret". Panichkin, "Some Results of NI Development."

Despite the compelling evidence and the rising opposition against the N1 engines, Kuznetsov refused to budge. Debates and arguments continued for some time over what Kuznetsov believed was inadequate dynamic testing of the N1 on the ground for precision loads, especially as compared to the Saturn V. Newly discovered sensor tapes near the impact site of the accident promised to throw the investigation into a lurch, but the new data only confirmed that Kuznetsov was wrong. In the final analysis of the fourth N1 launch, the State Commission stuck to the evidence of the "anti-engine faction," noting that there were other opinions. In its report, the commission stated that the flight had gone normally until T+106.93 seconds. Analysis of the probable causes of the failure indicated that:

- The damage to the aft compartment of the first stage because of a failure in engine no. 4 caused the explosion.
- The hypothesis that the engine failure occurred because of internal causes [that is, the engine] did not contradict the telemetry data from engine no. 4 and from the stand tests, the findings of an inspection of the physical materials, or the physical pattern of the development of the failure of the rocket.
- The hypothesis of the depressurization of the main lines feeding propellant to the main engines and the vernier engines before the beginning of the failure [Kuznetsov's version] was not confirmed by the telemetry data."

As the fingers all pointed to Kuznetsov, questions were rising all over the place on not only the old engines used on the N1 boosters so far, but also the newly improved engines his design bureau had been developing for two to three years. The issue had important long-term consequences precisely because of the tenuous connection between the old and new engines. If Kuznetsov was unable to build engines for the N1 after a ten-year research program, what guarantee was there that he would succeed with his new versions? Mishin himself recalled:

The difficulties encountered during the modification of those [liquid-propellant rocket engines], which were accompanied by repeated failures to meet delivery deadlines, generated in a certain circle of people (primarily, leaders such as D. F. Ustinov, L. V. Smirnov, S. A. Afanasyev) the opinion that N. D. Kuznetsov, given the existing attitude of the leadership of the Ministry of Aviation Industry toward the work, would not be able to bring the engines up to the specified level of reliability any time soon, and consequently, there would be neither an N1 launch vehicle nor its modified versions.⁸²

Perhaps to compensate for what many believed were Kuznetsov's shortcomings, the Soviet space leadership sanctioned parallel efforts in two other design bureaus in 1973 to develop substitute engines for the N1.

One of these two was a surprise participant in the N1 program: Chief Designer Valentin P. Glushko's Design Bureau of Power Machine Building (KB Energomash). More than ten years after the conflict with Korolev over the N1, which permanently fractured the Soviet space program, Glushko was finally ready to swallow his pride and join forces in the N1 program. He created a special team at his design bureau to investigate various ways to increase the reliability of the N1 rocket. One of these approaches was to outfit the first and second stages of the booster with engines that already had been repeatedly tested in flight, specifically altered versions of the RD-253 engines from the Proton rocket. Research, however, showed that an N1 equipped with such engines would lose significant lifting capacity because of the use of noncryogenic

81. Dolgopyatov, Dorofeyev, and Kryukov. "At the Readers' Request. The N1 Project."

82. Mishin. "Why Didn't We Fly to the Moon?"

propellants and also would cost the rocket in terms of reliability because the NI would have to have a huge number of such engines on the first stage. A second option was to use a new and much more powerful engine. Since about 1968, Clushko had been talking of a 1,000-ton-thrust engine for a superheavy-lift launch vehicle. The idea eventually evolved by early 1970 into a 600-ton engine using kerosene-LOX, the same propellants that Clushko had opposed using for the NI in the early 1960s. With the clouded future of the Kuznetsov engines, Glushko also directed a team under Sergey P. Agafanov at his design bureau to study a 5,000-ton-thrust engine with an annular combustion chamber and a nozzle of external expansion, with a central body that could be used on the first stage of the NI. Needless to say, the prospect of developing such a massively powerful engine was not very encouraging." The most realistic conception was a more modest 500-ton-thrust four-chamber engine, also using the kerosene-LOX combination.

Another organization, the Design Bureau of Chemical Automation (KB KhimAvtomatiki), the old Kosberg bureau led by Chief Designer Aleksandr D. Konopatov, also looked into substitute engines. They proposed a 250-ton-thrust motor working on LOX and kerosene, which would be developed on the basis of an old storable propellant engine developed many years ago for Chelomey's abandoned UR-700 rocket.

Despite the rising doubts about Kuznetsov's engines for the NI, Mishin's design bureau worked on two new NI boosters, 8L and 9L, "under a new technical task." Both of these rockets would be equipped with the new Kuznetsov engines on its first three stages. Just in time, ground static testing of the third-stage engine, the NK-31, had finished in November 1973, thus qualifying engines for all three stages. In preparing booster no. 8L for launch, engineers took account of all the results of the prior four NI launches, painstakingly making sure that such failures would not occur again. Booster no. 8L was significantly heavier than its predecessors, partly because of new oscillation dampers installed in propellant lines to preclude the type of depressurization suspected by Kuznetsov. The new rockets were also the first equipped with filters at the inlets to the oxidizer pumps of the engines, the absence of which had caused the catastrophic July 1969 failure. Other changes included an improved fire extinguisher system and a faster acting version of the KORD engine control system. There was also talk of installing a system to separate the first and second stages in case the former was damaged: if there had been such a system at the time of the fourth failure, the malfunctioning first stage could have separated from the rest of the booster, whose upper stages would have compensated for the loss of seven seconds of first-stage firing.⁸⁵

By early 1974, engineers had assembled booster no. 8L, allowing workers to begin installing Kuznetsov's new NK-33, NK-43, NK-31, and NK-41 engines on the rocket. The payload for the rocket was the first complete L3 complex, consisting of working versions of the LOK, the LK, and Blok D. The complex would enter lunar orbit, perform complex maneuvers, and then return to Earth without accomplishing a landing." Launch was scheduled for August 1974. Subsequently, booster no. 9L would fly before the end of the year. Confidence was at a high in early 1974. As some participants later recalled:

The people from the plants, Design Bureaus, and enterprises that had taken part in the development were preparing the rocket for flight with their former enthusiasm, because they had reason to believe that the launch would produce a positive result.⁸⁷

83 Afanasyev. "NI Absolutely Secret "

84. Tarasov, "Missions in Dreams and Reality "

85 Afanasyev. "Unknown Spacecraft". Afanasyev. "NI. Absolutely Secret."

86 Afanasyev. "NI: Absolutely Secret." In another article, the same author states that the flight program of booster no. 8L would have been a complete L3 mission, including *landing*. See Afanasyev. "Unknown Spacecraft."

87. Dolgopyatov, Dorofeyev, and Kryukov. "At the Readers' Request: The NI Project." p. 29.

By all accounts, the NI designers strongly believed that their faith in the rocket would be vindicated after so many years—that this last flight in 1974 would be the final test launch of the giant rocket, allowing the State Commission to declare the vehicle operational. Four additional boosters—IOL, I1L, I2L, and I3L—were in various states of assembly at the time, in the queue for launches in 1974 through 1976. Even the most pessimistic forecasts suggested that the NI would be flying regular operational missions by 1976.⁸⁸

Curtains

Early 1974 was a particularly important time for TsKBEM, precisely because it seemed, for the first time in a long time, that the unending setbacks of the previous three or four years were over. Chief Designer Mishin was presiding over six major new programs, all focused on piloted space exploration, which promised significant dividends in the late 1970s and early 1980s. Three programs involved the development of new variants of the Soyuz spacecraft, the most important of which was the 7K-S. This spacecraft had been in development since 1968, originally as a ferry vehicle to a long-abandoned military space station, but it had eventually emerged as a new generation of Soviet piloted spacecraft. In August 1972, Mishin had signed a supplement to the original draft plan for the 7K-S, which allowed engineers to proceed with the manufacture of the test and flight models. Although the spacecraft was externally almost identical to the older Soyuz, it was a completely new ship inside, with every essential system replaced by a new or modernized substitute." By May 1974, engineers had already built eight models of the 7K-S, one of which was almost ready for launch, although Mishin noted later that "the work was greatly slowed down by delayed deliveries by suppliers." In later years, this model was called the Soyuz T.

There were two other Soyuz variants in the works at the time, the first of which was the 7K-TM, built specifically for the Apollo-Soyuz Test Project. In the fall of 1972, engineers began work on this variant; Mishin signed the final draft plan on December 15, 1972." The variant had common systems with the new 7K-S, but it was designed particularly with the short time-frame of the joint project in mind; the most important addition was the new androgynous docking system developed jointly by the two sides. By mid-1974, six of these ships were ready for flight. The first one, vehicle no. 71, was launched on April 3, 1974, as Kosmos-638. TsKBEM introduced a new variant of the emergency rescue system for the IIA511 launch vehicle. The ten-day flight was successful, although it performed an unplanned ballistic, instead of a guided, return to Earth."

A third variant of the Soyuz was the 7K-TG—a spaceship designed to serve as a cargo ship to future space stations—that is, to bring propellant, food, and other supplies to crews staying on DOS ships in Earth orbit. It was a revolutionary idea for the Soviet space program and one of the most fundamental components of the USSR's ultimate goal of a permanent presence in space. Engineers began work on the tanker, later called Progress, in mid-1973 and issued the draft plan in February 1974.⁹³

88 Afanasyev. "NI Absolutely Secret". Semenov, ed. *Raketno-Kosmicheskaya Korporatsiya*. p. 258; Sergey Leskov "How We Didn't Get to the Moon" (English title), *Izvestiya*. August 18, 1989. p. 3. In one source, Mishin states there were seven total NI boosters in various states of readiness in 1974, suggesting that the additional boosters were I0L, I1L, I2L, I3L, and I4L. See Mishin. "Why Didn't We Fly to the Moon?"

89 Semenov, ed. *Raketno-Kosmicheskaya Korporatsiya*. p. 211

90. Yu. A. Mozzhorin, et al., eds., *Dorogi v kosmos*. I (Moscow: MAI, 1992), p. 125; Tarasov. "Missions in Dreams and Reality."

91 Semenov, ed., *Raketno-Kosmicheskaya Korporatsiya*, p. 198.

92 *Ibid.*, p. 202. Tarasov. "Missions in Dreams and Reality"; Mozzhorin, et al., eds., *Dorogi v kosmos*. I, p. 125; A. Yasinskiy, "Getting Away From the Fire" (English title), *Apogey* 4 (1993), 1, 3

93. Semenov, ed. *Raketno-Kosmicheskaya Korporatsiya*, p. 334.

Mishin had also significantly advanced work within the DOS program. Station no. 124, the fourth in the series, was almost ready for launch, being in "a state of 20-day readiness for launching" in late April 1974.⁹⁴ Station no. 125, the first third-generation station with two docking ports, was already in the process of assembly at the Khrunichev Plant in Moscow." These two stations were later launched as *Salyut 4* and *Salyut 6*, in 1974 and 1977, respectively. There was also significant work on the Multirole Orbital Complex (MOK) during the 1972–74 period. As per the agreement in 1972, Mishin expected to fully focus on the MOK after the flight of DOS no. 125.

The status of lunar programs remained in flux. Although the L3 program had been effectively terminated in late 1972, Mishin would fly out the remaining available hardware on several NI launches. Boosters 8L and 9L would carry out automated missions to the Moon. If those two were successful, the first Soviet piloted landing on the Moon would be on booster 10L or 11L. The subsequent five or six boosters would carry out further piloted landings or launches of the components of the MOK. Depending on the success of the early missions, designers planned to eliminate the use of the backup LK and the Ye-8 rover to support the later piloted landings.⁹⁶ The fate of the advanced L3M program is less clear. The available evidence suggests that after the closure of the Apollo program (after December 1972), the Soviet space leadership lost interest in the Moon. As one respected Russian historian noted at the time: "Money for the NI-L3M variation was not allotted."⁹⁷ As with many other programs of the period, however, it seems that Mishin doggedly carried on work on the L3M proposal without the benefit of an official Communist Party or government decree on the matter. According to his forecast in 1973–74, a successful L3M landing on the Moon could be achieved in 1978–80 "with only a small increase in spending in 1975–1976" above what was already allocated for the NI program.⁹⁸

If progress on these programs were to Mishin's credit, his record as TsKBEM Chief Designer during the previous eight years was nothing to brag about. It was during his tenure that two of the worst accidents in space history occurred—the Soyuz 1 and Soyuz 11 fatalities, which killed four Soviet cosmonauts. There were also the docking failures in Soyuz 213, Soyuz 718, and Soyuz 10, the repeated failures in the LI and DOS programs, and finally—most glaringly—the incredible catastrophes and delays in the NI rocket project. One could argue that Mishin was possessed of nine lives to have even survived this spate of failures; any other man would have been fired long ago. Some claim that he was protected in his position because of Andrey P. Kirilenko, the powerful Politburo member, whose son-in-law, Yuriy P. Semenov, was a chief designer at Mishin's design bureau.⁹⁹ Mishin was also not the easiest man with whom to get along, continually alienating his subordinates and associates with his abrasive behavior. In addition, he apparently had an unhealthy affinity for alcohol. But Mishin's vehement critics—and there are many—forget that he did not play a personal role in each and every failure that beset the design bureau in the late 1960s and early 1970s. His deputies—particularly Bushuyev, Chertok, Okhapkin, and Tregub—were responsible for managing many of the key programs during this period. And ultimately, Mishin had the poor luck of the draw. Handed too little money, too little time, and too many demands, possibly any other manager would have had the same results.

94 Mozzhorin et al eds. *Dorogi v kosmos* I p 125

95 Tarasov "Missions in Dreams and Reality"

96 K Lantratov "Anniversaries: The Deceased Lunar Plan" (English title) *Novosti kosmonavtiki* 14 (July 2–15 1994) 60–61

97 I Afanasyev "The Lunar Theme After NI L3" (English title) *Aviatsiya i kosmonavtika* no 2 (February 1993) 42–44

98 Mishin "Why Didn't We Fly to the Moon?"

99 Sagdeev *The Making of a Soviet Scientist* p 180

During the worst series of failures. in February 1973, the Ministry of General Machine Building issued a devastatingly censorious document on the TskBEM's activities, which was partly a direct criticism on Mishin's performance as its leader:

. . . in the past years the effectiveness of the work at the enterprise has noticeably dropped. . . Deficiencies exist at the enterprise in questions ensuring high quality and reliability of the apparatus created which have been repeatedly discussed in the Ministry Collegium (this has been reflected in a whole series of orders) which TskBEM has been eliminating slowly. . . on the question of the internal organization of TskBEM, there are yet more existing deficiencies¹⁰⁰ which have negatively manifested themselves in the work of the enterprise. . .

There was also dissension growing *within* the design bureau. In 1973, three of Mishin's most powerful deputies, Bushuyev, Chertok, and Kozlov, along with former OKB-1 Deputy Chief Designer Kryukov and TskBEM Department Chief Feoktistov, drew up and signed a letter, with the preliminary agreement of Central Committee Secretary Ustinov, to the Central Committee and the Council of Ministers pointing out the unsatisfactory work of Mishin as the Chief and Chief Designer of TskBEM. They finished their letter with a request to dismiss Mishin from his post."

The names of the signatories to the letter were not surprising. Bushuyev, Chertok, and Feoktistov had been vehement supporters of the DOS program, and all, especially Feoktistov, were increasingly lukewarm to continuing the trouble-plagued lunar program. Kozlov had had a falling-out with Mishin over the military 7K-VI program in the late 1960s and subsequently had an increasingly difficult time getting along with him. Kryukov had evidently had a spat with Mishin in 1966 soon after Korolev's death over an unknown matter, after which Mishin had demoted him from the post of deputy chief designer to department chief. Kryukov, like Bushuyev, Chertok, and Feoktistov, had also authored the important proposal in late 1969 to propose the DOS program in the first place."¹⁰¹ The fracture clearly developed over the DOS program. By all accounts, Mishin believed that the N1-13 lunar program was his life's work. As one journalist recalled, he considered it "to be his duty in Korolev's memory, as perhaps the most important accomplishment of his life."¹⁰² His deputies, Bushuyev and Chertok, were perhaps a little more pragmatic, believing that it was time to admit failure and move on to more manageable projects—that is, the DOS program. They had also clearly felt betrayed by Mishin's 1972 agreement with Chelomey in which the former promised to transfer the small space station program to the latter after the flight of DOS-5.

The N1 versus DOS debate split the design bureau in half. Mishin did have support within TskBEM Okhapkin, Dorofeyev, Shabarov, and others—deputies who were responsible for the N1-L3 program—apparently stood behind the besieged chief designer. Mishin also had the support of DOS Chief Designer Semenov, no doubt because the latter owed his career to Mishin. Both Semenov and local Party Secretary Anatoliy P. Tishkin evidently came out against the letter that called for Mishin's dismissal. In the official history of the design bureau, the

100 Semenov ed *Raketno-Kosmicheskaya Korporatsiya* p 161

101 *Ibid*

102 Bushuyev, Chertok, Feoktistov, and Kryukov were four of the six men who proposed the DOS program in late 1969. See *ibid* p 264. For the Kozlov-Mishin falling out over the 7K-VI see K. Lantratov, "Dmitriy Kozlov's Zvezda" (English title) *Novosti kosmonavтики* 6 (March 10-23, 1997) 74-80. For the Kryukov-Mishin falling out in 1966 see Mozzhorin *et al* eds *Dorogi v kosmos 1* p 101.

103 Mikhail Rebrov, "The Last Argument: A Study of the Designer in Black and White" (English title) *Krasnaya zvezda* March 25, 1995 p 6.

authors claim that Mishin managed to neutralize the effects of the damaging letter by coming to an agreement with space program head Ustinov. The latter was on visit in early 1973 to TsKBEM to mediate this growing conflict. Mishin was not informed of this sudden visit, perhaps to allow Ustinov free reign to discuss the matter with the "anti-Mishin" contingent. Upon finding out that Ustinov was at the premises of his design bureau. Mishin rushed to meet his boss and found Ustinov inspecting the DOS-3 model. The story goes that DOS Chief Designer Semenov mentioned in passing that it would be useful to have two docking ports on a future DOS vehicle. Ustinov liked the idea. In a subsequent conversation with Mishin, Ustinov, in a conciliatory mood, offered Mishin an implicit deal: if the chief designer would agree to have two docking ports on a future DOS vehicle, then Mishin could keep his job. The official historians add: "Thus V. P. Mishin found the possibility of continuing his work and at the same time was compelled to support the idea of a new station."¹⁰⁴

As with other tales of Soviet space history, it is difficult to discern the exact details of this story. The account clearly hinges on the idea that Mishin was in some way opposed to having two docking ports on a DOS spacecraft. Completely contradictory evidence comes from Mishin himself. In an interview in 1989, he clearly states that he wanted to have the *first* DOS with two docking ports but was overruled by Ustinov "in order to hasten our success."¹⁰⁵ Notes from Mishin's own office records of 1970–71 clearly attest to the serious considerations given to a station with two docking ports, as well as Mishin's own enthusiasm for such a station.¹⁰⁶ Despite these two irreconcilable accounts, one thing is clear: the 1973 letter calling for Mishin's dismissal was a key factor in the growing opposition against Mishin.

The trajectory of Mishin's career was, of course, undeniably intertwined with that of the NI-L3 program—an effort that was also under increasing attack at the time. Given the rising lack of confidence in Kuznetsov's engines, there were murmurs of discontent asking whether the program as a whole should be continued. As one historian noted:

The creators of the NI were being "called onto the carpet" more and more, and they had to prove their correctness each time. The rhythm of the work was disrupted owing to the confusion, and rumors were circulating in the corridors of the "firms" of the supposedly imminent "shutdown" of the NI.¹⁰⁷

At one meeting on December 8, 1973, Central Committee Secretary Ustinov bluntly asked whether it was still worth it to "ride the horse" any longer. One unnamed chief designer argued that it was time to terminate the program. When it was TsNIIMash Director Mozzhorin's turn, he made a case for continuing with the NI, but abandoning the lunar landing project:

To repeat what the Americans have done — this is to openly admit to the world our lag behind them. But as far as our NI carrier, what will canceling it do for the situation? After all, satellites are getting heavier each year; in time, such a carrier will nevertheless be needed! To throw away the NI at the halfway point — then the development of a new rocket of such lifting power will take a long time and vast resources . . . work on the NI must be continued!¹⁰⁸

104 Semenov, ed. *Raketno-Kosmicheskaya Korporatsiya*, p. 294.

105 Tarasov, "Missions in Dreams and Reality"

106 Interview, Peter Gorin by the author, November 18, 1997

107 Afanasyev, "The 'Lunar Theme' After NI-L3," p. 43

108. Mikhail Rudenko, "Four Steps From the Moon" (English title), *Moskovskaya praua*, July 19, 1994, p.

10. It is possible that this meeting may have occurred on December 8, 1972. The year is not given

As Influential as Mozhorin may have been, among the upper echelons of the Soviet space industry, his word could not compare to more powerful players.

Perhaps aware that the fate of the NI was on shaky ground, Mishin continued to appeal to both the Ministry of Defense and Communist Party officials that the continuing work on the booster would be invaluable for ultimately building the MOK, which would have both military and civilian mission goals. To get a firm word on the matter, Mishin, in cooperation with NI engine Chief Designer Kuznetsov, prepared a detailed memorandum for Soviet General Secretary Brezhnev on the MOK and on the general lag of the Soviet Union in the exploration of space. They proposed and argued various measures that would allow the USSR to move ahead of the United States. Mishin was not unaware that Kuznetsov was under fire at this time for his poor contributions to the NI program. In an attached section on the causes of the fourth NI failure, Mishin agreed to share the blame for the accident with Kuznetsov, hoping this would put Kuznetsov in a favorable light to Brezhnev. Mishin's closest aides thus put together a report on the entire NI program, the reasons for each failure, and the measures adopted to preclude future accidents. As far as the critical fourth failure in 1972, they noted—contrary to the official State Commission conclusion—that oscillations in the hull of the rocket caused by the switch-off of the central engines, accompanied by additional loads acting on pipelines—and the fact that the engines and their instrumentation were at the end of their resources—caused the subsequent explosion. Therefore, it was a compromise variant of the accident report. The two designers emphasized that in the succeeding launches, the level of vibrations would be decreased by throttling down the thrust levels of the central engines prior to cutoff."

In late March 1974, Mishin and Kuznetsov sent their memorandum to Brezhnev with a request to accept their proposals on the MOK and the NI. Brezhnev handed the report over to Ustinov to evaluate the proposal, and Ustinov turned it over to the defense ministries to handle the matter. Parties within the Ministry of Aviation Industry were of the opinion that the two chief designers' conclusions on the NI—that is, reducing the thrust of the engines prior to engine cutoff on future NIs—were completely unfounded, because without sufficient dynamic testing, it would be almost impossible to predict the outcome of such a profile. Thus, given the chance for failure, it would be foolhardy at best to give authorization to launch further NIs based on their recommendation. Ustinov eventually invited a number of prominent chief designers to discuss the Mishin and Kuznetsov proposal. Glushko, having waited for more than a decade to air his personal vendetta against the NI, did not hold back his words. He argued that new engines or not, the NI was doomed for failure because of the great number of engines in the first stage. Instead, Glushko proposed a new family of launch vehicles with very high-thrust engines.

In essence, Mishin made a fatal mistake by compromising his position and accepting Kuznetsov's views on the reason for the fourth accident. It was the last nail in the coffin. The pace of events in April and May 1974 was breathtaking. The maneuvering behind the scenes was done in absolute secrecy, with few people really aware of the wheeling and dealing. Perhaps as few as half a dozen people at TsKBEM were cognizant of the impending changes. One of Mishin's senior deputies, Yevgeniy V. Shabarov, an old-timer from the Korolev days, recalled later:

absolutely unexpectedly for us one day in 1974 we received an invitation, well not even an invitation, but an order to assemble all the Deputy Chiefs of the [design bureau] in the office of the Chief Designer. We gathered in complete ignorance. There we sat and waited. Suddenly the door opened, and [Minister of General Machine Building] Sergey Aleksandrovich Afanasyev entered, accompanied by Valentin Petrovich Glushko and a number of other employees from the Ministry. "Good afternoon, comrades." [Afanasyev]

109 Gladkiy, "The Last Launch of the NI Rocket."

CHALLENGE TO APOLLO

said. . . [He] announced that. "The Politburo has taken a decision—Vasily *Pavlovich Mishin* has been relieved of his post as Chief Designer of your organization, and Valentin *Petrovich Glushko* has been named the General Designer. Your organization from now on will be known as the 'Energiya' Scientific-Production Association. I wish you all success." With that he left. All this happened so unexpectedly and quickly (in the course of two–three minutes) that we were stunned and did not really understand what had occurred."

What happened was certainly the largest reorganization within the Soviet space industry since Korolev's death. On May 22, 1974, Mishin, at the time ill in the hospital, was officially released from his duties as TskBEM Chief Designer. On the same day, his former design bureau (TskBEM), with all its affiliates, was combined with another powerful space organization (Glushko's KB EnergoMash) to form the new Energiya Scientific-Production Association (NPO Energiya). It was evidently Glushko who had personally thought of the "Energiya" name. The sixty-five-year-old Glushko was named the new Director and General Designer of this new and gargantuan empire, which included:

- The former TskBEM, renamed the Lead Design Bureau (GKB) at Kaliningrad
- The former TskBEM branch at Kuybyshev
- The Experimental Machine Building Plant at Kaliningrad
- KB EnergoMash at Khimki
- KB EnergoMash's Primorsk Branch
- KB EnergoMash's Kamskiy Branch
- KB EnergoMash's Privolzhsk Branch
- The EnergoMash Experimental Plant"

Thus, Glushko would supervise the development of almost all Soviet piloted spacecraft, launch vehicles, automated reconnaissance satellites, and high-thrust rocket engines and oversee their manufacture and testing. It was more power than Korolev held in his heyday. Being ill at the time, Mishin was out of the loop throughout this period. As Mishin told a journalist many years later:

To be frank with you, the *decision* to fire me came to me as a complete surprise. . . . [After leaving the hospital] I was invited for a talk to the Staraya Square [the residence of the Central Committee of the Communist Party], and *Ustinov*, the Central Committee Secretary in charge of space affairs, told me. "Leonid *Ilyich [Brezhnev]* asked me to convey his thanks for your work, and provide help in finding other employment. ""

Presumably, Mishin would have been demoted to a senior position in the design bureau, but Glushko would have none of that. When Mishin left the hospital, Glushko revoked Mishin's clearance pass to enter the design bureau." The new general designer wanted to make sure that Mishin never stepped into his old haunting grounds again.

The natural question is: why Glushko? How did Glushko manage to end up as head of the enterprise that was founded by one of his most famous opponents, Korolev? Glushko was

110 Mozzhorin, et al., eds., *Dorogi v kosmos* I, p. 183 The Politburo meeting to discuss the reorganization was held on May 14, 1974

111 Semenov, ed., *Raketno-Kosmicheskaya Korporatsiya*, p. 288 Note that the TskBEM branch at Kuybyshev separated from NPO Energiya on July 30, 1974, and became the Independent Central Specialized Design Bureau (TsSKB)

112. Rebrov. "The Last Argument "

113 Tarasov. "Missions in Dreams and Reality "

clearly well placed and also ambitious. Since the birth of the missile program in the mid-1940s, he had always played second fiddle to Korolev. He was always the engine designer, while Korolev was the designer of the rocket or the spacecraft. His claim to become the chief designer had no support while Korolev was alive. But with the less-powerful Mishin, Glushko could take advantage of the former's failings, such as the repeated failures in the late 1960s and early 1970s in the piloted space program. By 1971, Clushko was clearly the most respected and influential chief designer in the business, as evidenced by the unprecedented declassification of his name. His organization had designed the engines for the first stages of almost all Soviet strategic ICBMs, including the R-7 (SS-6), the R-9A (SS-8), the R-16 (SS-7), the R-36 (SS-9), and the R-36M (SS-18). This does not include his design bureau's work on engines for a family of launch vehicles based on the R-7, as well as Yangel's Tsiklon and Kosmos series of boosters. Still, he remained only the engine designer. Presumably during the discussions in early 1974 over the NI, when he offered a replacement for the old rocket, he proposed uniting his rocket engine organization with that of Korolev's old spacecraft design bureau. From a managerial and institutional perspective, it seemed to make sense to unite these two powerful entities into one. Forces would be consolidated, and waste would be eliminated. Who was better to head the whole organization than Clushko, one of the pioneers of Soviet rocketry? On a more fundamental political level, Glushko had the support of two key individuals, Brezhnev and Ustinov. Their support was invaluable to his appointment."¹⁴

The NI-L3 project was the first victim of the May 1974 reorganization. The fate of the project was clearly decided at the highest levels of the Soviet Communist Party and government, but it was also a decision that stemmed from a confluence of forces that all intersected in mid-1974. Clearly one of the most important factors was the Mishin-Kuznetsov report sent to Brezhnev in March. The repercussions of this report spiraled out of control until it reached the offices of the primary client for the NI, USSR Minister of Defense Andrey A. Grechko. Given his generally negative attitude toward the NI booster and its military uses, he was only too happy to side with those who were clamoring for some definitive action. On May 19, 1974, three days before Mishin's official dismissal, Grechko signed an order suspending further launches of the rocket.¹⁵ The timing could not have been better. Clushko's first act as General Designer of NPO Energiya, signed on June 24, 1974, was to suspend all work on the NI-L3 program.¹⁶ The suspension of work on the NI meant that all programs associated with its development were also terminated. These included the L3M advanced lunar landing missions, the giant MOK in Earth orbit, and proposed conceptions of anti-ballistic space-based weaponry. The massive expansion of the Soviet space program, envisioned for the late 1970s by Mishin, all disappeared with a few signatures.

In the official history of NPO Energiya, the authors wrote that the decision was taken with the "tacit agreement" of Afanasyev, Keldysh, Smirnov, and Ustinov. One person who may have been against this abrupt decision was Minister of General Machine Building Afanasyev, who, while not always supportive of Mishin, was a strong proponent of the NI program. Some reliable sources claim that both Clushko's appointment and the cancellation of the NI-L3 program "was made by the Politburo behind Minister Afanasyev's back. . . . It was [Clushko's] initiative, not of his boss — Afanasyev."¹⁷ In recent years, Mishin has been very candid about who

114 See Col. M. Rebrov "Specific Impulse" (English title). *Krasnaya zvezda*, August 26 1989, p. 4

115 Gladkiy, "The Last Launch of the NI Rocket "

116 Semenov, ed. *Raketno-Kosmicheskaya Korporatsiya*, p. 639.

117. *Ibid.*, p. 258

118 Georgiy Stepanovich Vetrov, "Development of Heavy Launch Vehicles in the USSR," presented at the 10th International Symposium on the History of Astronautics and Aeronautics, Moscow State University, Moscow, Russia, June 20-27, 1995

he believes were responsible for scuttling a program that had sucked in billions of rubles, but was so close to success:

I think the main culprit was Dmitriy Fedorovich Ustinov. The reason for winding up the program—at least from his standpoint—was that the Americans had beaten us to it. This was a turning point in his career. Prior to this, he had not been a Politburo member, much less the Minister of Defense. He reached these positions after winding up the [N1] program. Afanasyev could not have cared less. All these failures were affecting his career. So he did not oppose winding up the N1 program."

Both Ustinov and Afanasyev kept their jobs. However, Mishin was not the only one whose job came under fire. Maj. General Kerim A. Kerimov, the Chief of the Third Chief Directorate at the Ministry of General Machine Building, was apparently demoted as part of the N1 cancellation shakeup. He continued to serve as chair of the State Commission for Soyuz, but he would no longer oversee the Korolev design bureau within the ministry.¹¹⁹ Others who fell under the blade included several leading engineers responsible for the NI-L3. Once Glushko came into power, he sidelined some of the senior personnel involved in the N1 project. N1 Chief Designer Dorofeyev was "forcibly dismissed," while Mishin's First Deputy Okhapkin, who had guided the program since 1962, was demoted to an innocuous position.¹²⁰ The men who inherited senior positions at NPO Energiya were, for the most part, those individuals who had little involvement in the NI-L3 effort during the past few years.¹²¹

The termination of the NI-L3 program was a complete surprise to most people at NPO Energiya, and it sent shock waves throughout the entire space industry. Engineers, confident beyond hope that success in the program was within reach, were simply stunned at the irony of cancellation at the cusp of victory. Especially galling was the fact that "not a single session of a scientific council, not a single conference of specialists, not a single meeting of the Council of Chief Designers" was convened prior to taking the final decision—it was all decided behind closed doors among less than half a dozen individuals. As one journalist wrote: "It was far less dangerous to transfer the responsibility onto other shoulders and to declare the N1 a mistake."¹²² Perhaps the biggest victims were the engineers: without any intention of hyperbole, one observer noted:

¹¹⁹ What Stars Are We Flying to? (English title) Moscow Teleradiokompaniya Ostankino Television First Program Network Moscow April 9 1992 0825 GMT

¹²⁰ Leonard Nikishin "Inside the Moon Race " Moscow News 7 (April 11 1990) ¹²¹ Kerimov's new post was First Deputy Director of TsNII Mash

¹²¹ For Dorofeyev see S Kryukov 'The Brilliance and Eclipse of the Lunar Program' (English title) Nauka i zhizn no 4 (April 1994) 81-85 Dorofeyev evidently did not leave NPO Energiya By December 1977 he was Chief of Complex 10 at NPO Energiya responsible for ground testing which was definitely a demotion from his post in 1972-74 Okhapkin's fate is less clear His official biography states that he was a deputy chief designer until 1976 See V P Glushko ed Kosmonavtika entsiklopediya (Moscow Sovetskaya entsiklopediya 1985) p 286 However complete lists of deputy chief designers at NPO Energiya from 1974 to 1977 do not include his name See Semenov ed Raketno Kosmicheskaya Korporatsiya pp 288-93

¹²² The new structure of NPO Energiya was approved on June 28 1974 Glushko had two First Deputy General Designers One of them was Yu N Trufanov appointed to his post on July 16 1974 Trufanov was an odd choice for the position because he had come from Chelomey's TsKBM Fili Branch The other was V P Radovskiy who had served under Glushko for a long time at KB EnergoMash Glushko had five Chief Designers under him—K D Bushuyev Ya P Kolyako I S Prudnikov I N Sadovskiy and Yu P Semenov—responsible for particular the main areas in the organization There were also seven Deputy General Designers A P Abramov B Ye Chertok M S Khomyakov A A Rzhakov Ye V Shabarov V V Simakin and A S Yeliseyev See Semenov ed Raketno Kosmicheskaya Korporatsiya pp 288-90

¹²³ Leskov 'How We Didn't Get to the Moon'

As for such a "detail" as the honorable work of thousands of people who had devoted their best years to the NI, this was not even considered, these people did not even receive any explanation, let alone consultation . . . and many of them. I am convinced. received such a psychological blow that they have been unable to create anything of equal worth. And these were Korolev's best cadres.¹²⁴

Another participant remembered how Brezhnev and Ustinov compensated for their actions:

On the eve of those sorrowful events, many people who had taken part in the work in the lunar project. . . were presented with decorations. I admit that at that time I did not really understand why. It later became clear: we were decorated as a consolation and so that we would hold our tongues."

Unable to comprehend the rationality of such a seemingly uninformed decision, many unusual reasons filtered through the grapevine. Perhaps the most compelling one was that Soviet space officials were simply afraid that the NI would succeed on its next launch. As one engineer working on the program recalled: "A successful launch of no. 8 . . . would require new investments that would be both considerable and immediate."¹²⁶ Military-Industrial Commission Chairman Smirnov seemed to confirm this claim. when, in 1991, he admitted that the general consensus, even among the upper leadership, was that the next launch would have been a success.¹²⁷

When he took control of the giant Energiya organization. Glushko did not come empty-handed. He had promised Ustinov that he could do better than the NI. and in one sense, he did not disappoint. During his first days as general designer, he invited the technical leadership of the organization and presented his vision of the future of Soviet space exploration: a new family of superheavy-lift launch vehicles, ultimately leading to the establishment of large-scale permanent bases on the surface of the Moon. While most attendees viewed the lunar base idea with "great skepticism," it seems that Glushko had Ustinov's support, at least at the proposal level.¹²⁸ Why, after canceling Mishin's L3M and Long-Duration Lunar Base. Ustinov would support Glushko's "new" ideas might mystify even the most cursory observer of Soviet space history. Many within NPO Energiya were against the idea, correctly noting that the proposal was completely absurd after the NI debacle. By October 1974. Glushko's engineers worked up a formal technical proposal for a lunar base, called *Zvezda*, which was examined by an independent expert commission of scientists and engineers headed by USSR Academy of Sciences President Keldysh. Looking at the costs, the technical complexity, and the timeframes proposed, the commission unanimously rejected *Zvezda*. In desperation. Glushko tried to get signatures from leading Soviet scientists on the viability of his proposal. But even Brezhnev, when told that this project would cost "only" 100 billion rubles, sobered up and declined to approve it. *Zvezda* died soon after.¹²⁹

¹²⁴ Ibid

¹²⁵ Vad Pikul "The History of Technology How We Conceded the Moon A Look by One of the Participants of the NI Drama at the Reasons Behind It" (English title) *Izobretatel i ratsionalizator* no 8 (August 1990) 20-21

¹²⁶ Ibid

¹²⁷ V L Menshikov *Baykonur moya vol i lyubov* (Moscow MECUS 1994) p 199

¹²⁸ Semenov ed *Raketno-Kosmicheskaya Korporatsiya* p 288 The family of new launch vehicles were informally known as Croza Crom and Vulkan Their ground to Earth orbit payload capabilities were RLA 120 Croza (thirty to thirty five tons) RLA 135 Grom (100 tons) and RLA 150 Vulkan (170-250 tons) Croza and Crom respectively became Energiya M and Energiya

¹²⁹ Sagdeev The Making of a Soviet Scientist pp 182-84 Afanasyev 'The Lunar Theme After NI L3' Afanasyev 'Unknown Spacecraft' German Nazarov 'You Cannot Paper Space With Rubles How to Save Billions' (English title) *Molodaya guardiya* no 4 (April 1990) 192-207

If Zvezda proved to be too much for the Soviet space leadership, there was more interest in Glushko's new family of superheavy-lift launch vehicles. The military had at last found a use for such powerful boosters. Since 1972, the United States had embarked on the development of the reusable Space Shuttle. Believing the Space Shuttle to be a military threat to the Soviet Union, officials in the USSR Ministry of Defense found little interest in lunar bases or giant space stations. What they wanted was a parallel deterrent to the Shuttle. The story of exactly why the Soviets believed the Space Shuttle was such a threat has, like many others, assumed mythological proportions, with the truth probably buried forever in secret archives. The most commonly propagated story, disseminated even by the most respected historians in Russia, has an air of a folk tale:

Leonid Smirnov, former [Military-Industrial Commission] Chairman . . . in his regular report to Brezhnev on the state of our space efforts once mentioned . . . that the Americans are intensively working on a winged space vehicle. Such a vehicle is like an aircraft; it is capable through a side maneuver of changing its orbit in such a way that it could find itself at the right moment over Moscow — possibly with a dangerous cargo. The news disturbed Leonid Ilyich [Brezhnev] very much — he contemplated it intensively, and then said, "We are not country bumpkins here. let us make an effort and find the money."¹³⁰

Several different organizations offered their services to develop a counterpart to the American Shuttle. In the initial stages, none of them resembled the U.S. spacecraft in the slightest. Glushko proposed a radically new design for a Soviet counterpart, the Reusable Vertical-Landing Transport Craft (MTKVP), a wingless system based on his new superheavy launcher proposal. Chelomey offered up the twenty-ton Light Space Aircraft (LKS)—an advanced reusable spaceplane concept to be launched on the Proton rocket. The MiG design bureau's old "space branch" in Dubna, after years of fruitful work on such concepts, offered up its old Spiral spaceplane. In February 1976, the chief of the space branch, Yuriy D. Blokhin, visited the Central Committee to persuade top Party leaders that the Spiral would be the most cost effective and efficient response to the American Space Shuttle, citing NASA's work on such experimental aircraft as the X-24. It was all in vain. Brezhnev, Smirnov, and particularly Keldysh were unwilling to budge on their requirement for a system identical to the NASA Space Shuttle, despite overwhelming opposition from most senior chief designers in the Soviet space program." In 1993, Efraim Akim, a scientist at Keldysh's Institute of Applied Mathematics, elaborated on the precise rationale behind the "parallel response":

When the U.S. Shuttle was announced we started investigating the logic of that approach. Very early our calculations showed that the cost figures being used by NASA were unrealistic. It would be better to use a series of expendable launch vehicles. Then, when we learned of the decision to build a shuttle launch facility at Vandenberg [Air Force Base] for military purposes we noted that the trajectories from Vandenberg allowed an overflight of the main centers of the USSR on the first orbit. So our hypothesis was

130. B. Olesyuk, "The 'Buran' Blind Alley" (English title), *Kuranry* December 21, 1991, p. 8. See also Yaroslav Colovanov, "Just Where Are We Flying to?" (English title), *Izvestiya*, December 12, 1991, pp. 1, 3.

131. Afanasyev, "Unknown Spacecraft": Mikhail Rudenko, "Star Wars — History of the 'Death' of a Unique Spaceplane" (English title), *Trud*, August 26, 1993, p. 6; Anatoliy Kirpil and Olga Okara, "Designer of Space Planes. Vladimir Chelomey Dreamed of Creating a Space Fleet of Rocket Planes" (English title), *Nezavisimaya gazeta*, July 5, 1994, p. 6; Vyacheslav Kazmin, "The 'Quiet' Tragedy of EPOS" (English title), *Krylya rodiny* no. 1 (January 1991) 4–5. Note that by this time, the "space branch" was no longer under the MiG design bureau's jurisdiction. It had become a part of DPKO Raduga on June 19, 1972.

that the development of the shuttle was mainly for military purposes. Because of our suspicion and distrust we decided to replicate the shuttle without a full understanding of its mission. When we analyzed the trajectories from Vandenberg we saw it was possible for any military payload to reenter from orbit in three and a half minutes to the main centers of the USSR, a much shorter time than [a submarine-launched ballistic missile] could make possible (ten minutes from off the coast). You might feel that this is ridiculous but you must understand how our leadership, *provided* with that information, would react.¹³²

Despite almost no interest from the Ministry of Defense, Keldysh managed to bulldoze the Soviet space shuttle idea was bulldozed through the Communist Party and government. On February 17, 1976, the Central Committee and the Council of Ministers issued a formal decree, which approved the creation of a reusable space system consisting of:

- A launcher stage
- An orbital aircraft
- An interorbital tug-ship
- A complex control system
- A launch-landing and assembly-work complex

The orbital aircraft would ensure delivery of up to thirty tons of payload to a 200-kilometer-altitude orbit, and it would be capable of returning twenty tons back to Earth." Glushko's NPO Energiya would serve as the primary contractor for the entire system. The decree committed the Soviet Union to certainly the most expensive space project in the country's history—one that would almost bankrupt the space program. Chasing after the U.S. Space Shuttle over the following twelve years, it would work on a new launcher, the 11K25, later called Energiya, and a new reusable space shuttle, the 11F25, later called *Buran*.

To build the new shuttle, Glushko evidently did not want to work with organizations such as the Mikoyan or Chelomey design bureaus, which had decades of experience in developing hypersonic reusable vehicles. Instead, he subcontracted the development of the *Buran* shuttle to a new organization, the old Molniya Scientific-Production Association (NPO Molniya), created specifically for this task on February 24, 1976. NPO Molniya was established in Tushino near Moscow on the basis of the old Molniya Design Bureau (the former OKB-4) led by Chief Designer Matus R. Bisnovat—an entity that had hitherto zero experience in designing such spacecraft. Bisnovat's specialty had, in fact, been developing air-to-air missiles for Soviet fighters. NPO Molniya also included the Burevestnik Design Bureau (the former KB-82) led by A. V. Potoplov, which had specialized in the design of surface-to-air missiles and the manufacture of Sukhoy's advanced T-4 supersonic bomber. The third component was the Experimental Machine Building Plant (the former KB-90) led by Chief Designer Vladimir M. Myasishchev, who had been pushed out of space design work many years previously by Chelomey.¹³⁴ As a single act of concession to earlier spaceplane research, Ustinov appointed Spiral program chief

¹³² James Harford *Korolev: How One Man Masterminded the Soviet Drive to Beat America to the Moon* (New York: John Wiley & Sons, 1997) p. 314

¹³³ Semenov ed. *Raketno Kosmicheskaya Korporatsiya* p. 362

¹³⁴ Stepan Mikoyan "Molniya: From 'Spiral' to MAKS" (English title) *Vestnik vozdushnogo flot 1* (1997) 60. G. P. Svishchev ed. *Aviatsiya entsiklopediya* (Moscow: Bolshaya Rossiyskaya entsiklopediya, 1994) p. 372. E-mail correspondence Mark Hillyer to the author, March 29, 1998. Additional manufacturing for *Buran* would be carried out at the Tushino Machine Building Plant (the former Plant No. 82) under Director S. G. Arutyunov. Note that both KB Molniya and KB Burevestnik were also located on the premises of the Tushino Machine Building Plant (TMZ).

Lozino-Lozinskiy to be the Director and Chief Designer of NPO Molniya. transferred from his old duties at the MiG design bureau. Despite Lozino-Lozinskiy's undeniable expertise. NPO Molniya seems to have been ill-equipped to handle such a monumental task as building a copy of the American Shuttle. One Soviet historian wrote:

And can we manage to explain why the building of such a unique design as our first space plane was assigned to NPO Molniya and the Tushino Machine Building Plant (TMZ)? I'm not trying to insult those renowned, talented collectives, but everyone knows that NPO Molniya came about in the consolidation of two small design offices, Molniya and Burevestnik, which not only never had anything to with brainstorming about a space-plane, but also had no experience in developing ordinary airplanes from start to finish."

Ignoring the decades of spaceplane research by Tsybin, Tupolev, Myasishchev, Mikoyan, and Chelomey, institutional discord and bad judgment once again set the Soviet space program on a poorly managed endeavor. Thus, Chelomey's Light Space Aircraft died an ignominious death by 1981, while Spiral puttered on until September 1978. Despite some extraordinarily successful subsonic drop tests in 1977 and 1978 from a Tu-95K bomber, the space branch at Dubna was eventually shut down. In December 1981, forty-eight senior engineers from the Spiral design bureau were ordered to pack up and join NPO Molniya to help with the creation of Buran.¹³⁶

Fittingly, the same decree approving work on the I1K25 system (as the complete Energiya-Buran system was called at the time) also conclusively terminated all work on the NI-L3 program. The official reasoning was "the necessity to commence large-scale activities (involving allocation of huge sums of money) on the [Energiya-Buran] project" and more ironically "the absence of heavy payloads suitable for the lifting capacity of the launcher."" Amazingly, this was the same decree that approved the I1K25 superheavy-lift launch vehicle! In one of the multiple ironies of the time, Glushko elected to develop cryogenic propellant engines for the I1K25, despite having literally cracked the Soviet space program in half during the early 1960s by refusing to build engines with those propellants. Given the use of LOX-kerosene engines, there was some talk of using the Kuznetsov's new NI engines for the job. At his own risk, Kuznetsov had continued his test certification program for the new engines, which continued as late as January 1977. His results were impressive: in running forty different NK-33 first-stage engines for test regimes of 1,200 seconds, they ran an average of 7,000-14,000 seconds without failures. One engine fired for a sum total of 20,360 seconds during repeated testing. To pass the certification process, they needed to run for only 600 seconds. In addition, he had boosted the thrust of the original NK-33 engines from 154 tons to 205-207 tons through the minor reworking of the turbopump assembly, moving the engines into a completely different class of thrust. Glushko naturally felt threatened by all this. In 1977, as his power increased to unprecedented levels, he forced a formal decision from the Council of Ministers to terminate all work done on powerful liquid-propellant rocket engines at not only Kuznetsov's design bureau, but also any place under the Ministry of Aviation Industry. Kuznetsov was also forced to hand over some of his test equipment to Glushko.¹³⁸

135 Yaroslav Colovanov. "Just Where Are We Flying to?" p. 1.

136 Kazmin. "The 'Quiet' Tragedy of EPOS". Lardier. *L'Astronautique Soviétique*, p. 254.

137 For the former quote, see S. Shamsutdinov. "First Flight of Buran With Tourists on Board Will Take Place on April 12, 1994" (English title), *Novosti kosmonavtiki* 21 (October 9-22, 1993) 40-45. For the latter quote, see Afanasyev. "NI: Absolutely Secret."

138 Afanasyev. "NI: Absolutely Secret."

The total cost of the N I-L3 program up to January 1, 1973, was 3.6 billion rubles, of which 2.4 billion rubles was specifically for the N I.¹³⁹ By rough estimates, total expenditures by the mid-1970s may have been as high as 4.0–4.5 billion rubles." It is difficult to convert this figure to a dollar value, but a rough estimate, in 1960s dollars, would be about \$12–13.5 billion—that is, about half of that spent on the Apollo program. But there was a human cost, too, and many, having received such a crushing blow, were reluctant to let the dream go. In a desperate gambit that ultimately met with little success, former Chief Designer Mishin lobbied hard to obtain permission to launch two of the fully prepared N I rockets into the Pacific Ocean. In 1976, N I Chief Designer Dorofeyev wrote letters to members of the 25th Congress of the Communist Party for the test launches. In November 1976, Mishin and Chertok sent a proposal to the Ministry of General Machine Building to convert the N I to launch the new reusable space shuttle for the Ministry of Defense.¹⁴¹

None of it worked. Glushko was dead set against it: he was not simply satisfied with consigning the N I program to history, but he also wanted to erase it from history. He ordered all the remaining N I rockets—the two fully prepared for launch and five others—to be destroyed. All associated technical documentation was also destroyed, thus squelching any possibility that the rocket would make a phoenix-like reappearance in the Soviet space program. Former OKB-1 Deputy Chief Designer Sergey S. Kryukov, one of the "fathers" of the N I, later wrote: "Glushko incinerated every notion of the N I with a hot iron."¹⁴² Glushko also made sure that there was no indication of the program's existence in the design bureau's private museum. The project would only exist in the memories of its participants. The dream that had begun with Sergey Pavlovich Korolev in Germany in 1945 ended with a few signatures in 1976. Russian journalist Yaroslav K. Golovanov, Korolev's most well-known biographer, perhaps wrote the most eloquent of epilogues on the life and death of the N I project:

The unfulfilled dream of Sergey *Korolev*, who died on the operating table—a dream that was decimated by Valentin Glushko, that was undefended by Vasilii *Mishin*, and that took years of labor by *Nikolay Kuznetsov*—vanished in the gulf of ministerial paperwork and the flames of failed launches that turned billions of rubles into ashes."

Mishin added:

We felt a deep sense of sadness. It was a colossal project to which we dedicated our best years. I was young at the time. And it was the work of a great many people and it vanished overnight. The Americans had won. I was made the *scapegoat*.¹⁴⁴

139 Dolgopyatov Dorofeyev, and Kryukov. "At the Readers' Request. The N I Project." Total planned cost, including that for sixteen flight models, was 4.97 billion rubles.

140 For 4 billion rubles, see Kryukov. "The Brilliance and Eclipse of the Lunar Program " For 4.5 billion rubles, see Leskov, "How We Didn't Get to the Moon "

141 Leskov. "How We Didn't Get to the Moon". Panichkin. "Some Results of N I Development": Lardier. *L'Astronautique Soviétique*, p. 174.

142 Kryukov, "The Brilliance and Eclipse of the Lunar Program "

143 Colovanov. "Just Where Are We Flying to?." p. 1

144 "The Russian Right Stuff. The Dark Side of the Moon." NOVA television show. #1808. WGBH-TV, Boston. February 27, 1991



CHAPTER NINETEEN

TOMORROW NEVER KNOWS

In the history of the Soviet space and missile programs, three singular events stand out as defining moments: the birth of the effort in 1946, the death of Korolev in 1966, and the end of the NI-L3 program in 1974. History, of course, does not separate itself into neat little segments of time, but it would be difficult to find a moment so cataclysmic in the U.S. space program as the Soviet events of 1974. In essence, the year divided the old with the new and a lack of vision with clarity. Completely unknown to the West until the late 1980s, the changes in 1974 were effectively a watershed moment that closed the door on Korolev's determined journey, begun in 1946. What happened after 1974 warrants particular attention, not only as a matter of historical interest, but because the nature of the Soviet piloted space program changed in ways that would have been difficult to foresee at the time of NPO Energiya's formation. Having trudged through failure after failure in the late 1960s and early 1970s, the Soviet Union finally made its arrival as a formidable space superpower in the late 1980s—a full two decades after its only competitor had done the same.

The Rise and Fall of a Space Power

Glushko's ascendance to power at the top of the pyramid coincided with a dramatic shift in fortunes for the Soviet piloted space program. All the failures and catastrophes of 1971 through 1973, especially in the space station effort, seem to have exorcised the demons of the Soviet space program. In 1975, NPO Energiya performed its first fully successful space station mission on *Salyut 4*, one of the two DOS vehicles readied under Mishin. The other one, launched in September 1977 as *Salyut 6*, would finally put the Soviet space program on the slow but persistent track to success. The station's mission was one of the finest success stories in the Soviet space program. In the four years after launch, it hosted sixteen crews, four of which set absolute endurance records for time in space, significantly exceeding the eighty-four-day record set by NASA's *Skylab 4* crew during 1973–74. NPO Energiya also introduced two new spacecraft: the *Progress*, an automated tanker and supply ship, and the *Soyuz T*, an advanced version of the *Soyuz*. Ironically, both programs had been initiated by Mishin. It was not simply a matter of setting records but of remarkable maturity in operations. Engineers perfected the very first refueling operations in space, mastered the logistics of having two ships dock to the same station, directed complex repair spacewalks outside the station, managed real-time solutions to contingencies in space, and accumulated a wealth of ground-breaking information on the effects of microgravity on the human organism. The Soviets also extracted maximum political gain from the mission of *Salyut 6* by sending "guest-cosmonauts" from other socialist countries on "friendly" visits. There were no fatalities in the program. It was a stunning return to

form, prompting many Western observers to conclude that the Soviets were "ahead" in space. During the same period, the United States accomplished only one piloted flight.

The string of successes in the space station program continued with the operation of Salyut 7 during the 1982–86 period, culminating with the launch of Mir ("World") in February 1986. Crews began visits to Mir almost immediately after its launch. In September 1989, two cosmonauts, Viktorenko and Serebrov, began a historic run of ten years of continuous crewed operations. Through the dissolution of the Union of Soviet Socialist Republics in late 1991, Mir remained occupied. In 1994–95, Valeriy A. Polyakov, a doctor from the Institute for Biomedical Problems, set the world's endurance record for continuous time spent in space: 438 days.

What had been a closed and secret program began to open up during the early 1990s. Mir played a central role in cooperative agreements with Western nations. As part of an arrangement between the United States and the Russian Federation, NASA astronauts began visiting the Mir space station in 1995. Seven NASA astronauts, beginning with Norman E. Thagard, spent approximately two and a half years aboard the Mir space station between 1995 and 1998. Their quarters were Irving, breathing, orbiting artifacts of the amazing history of the Soviet space program. The main Mir hull is almost identical to the original DOS vehicle that was designed and launched as the first Salyut in 1971. The same triumvirate that had built the original Salyut created the newer station, but these organizations exist now with different names: RKK Energiya, the Salyut Design Bureau, and the Khrunichev State Space Scientific-Production Center. The primary four *Mir* modules—*Kristall*, *Kvant-2*, *Spektr*, and *Priroda*—were all based on the design of the Transport-Supply Ship's main hull, itself part of Chelomey's conception of the Almaz space station complex proposed in the late 1960s. The launch vehicle for *Mir* and its modules is the Proton—a rocket originally known as the UR-SOOK, proposed by Chelomey as an ICBM in 1960. The delivery vehicles for the complex are the Soyuz TM and the Progress M spacecraft, both derived from Korolev's beloved 7K-OK Soyuz spacecraft, designed in the early 1960s.

Mir, with all its historical significance, was planned for deorbiting by the end of this century. By that time, there will be a more impressive sight in Earth orbit, the International Space Station, a cooperative project involving sixteen countries. As the primary participants, the United States and the Russian Federation will provide most of the materials for this largest ever joint program in the history of space exploration.¹ The first component of the station, the Zarya Functional Cargo Block, was launched in November 1998 on a Proton booster. The station will be supplied by various modifications of the Soyuz spacecraft. Mir operations will probably cease once activities on the International Space Station commence. That singular event will probably mean the end of an independent Russian piloted space program—the end of the journey that Yuriy Alekseyevich Gagarin began in 1961. It will be the beginning of a new and perhaps more exciting voyage.

The Salyut and Mir space station programs were the most publicized components of the Soviet space program in the 1980s, but they were not, in fact, the most important. The lion's share of the Soviet space budget during the 1980s was taken by the Energiya-Buran effort, the most expensive program in the history of the Soviet space program. After years of delays and cost overruns, NPO Energiya finally launched the first Energiya booster in May 1987. It was the first successful Soviet rocket comparable in power and performance characteristics to NASA's long-defunct Saturn V giant. It was also the first time that the Soviets fired a high-performance LOX-liquid hydrogen rocket engine in operational conditions. What little joy there may have been in such a test was tempered by history. All of the pleas by Korolev and Mishin during the 1960s to develop such engines had fallen on deaf ears, leaving Soviet rocket capabilities far behind that

¹ The Salyut Design Bureau (KB Salyut) is actually part of the Khrunichev State Space Scientific Production Center (GKNPTs Khrunichev)

² Paul Mann "U.S. Russia Draft Historic Space Pact" *Aviation Week & Space Technology* September 6, 1993 pp 22–23

of the United States. It finally took Glushko's change-of-heart about cryogenic propellants before Korolev's dream became a reality. The Energiya booster was fired a second time, in November 1988, when it launched the Soviet space shuttle Buran on a highly impressive fully automated orbital flight. After decades of trying to build a spaceplane, Buran turned out to be the only such Soviet vehicle that ever made it into orbit. It was only fitting that much of the success of Buran benefited from the intensive testing of the small-scale BOR spaceplanes in the 1980s—vehicles that were left over from the ambitious Spiral project from the 1960s.

Despite early expectations of a vigorously expanding Soviet space program, the inevitable disenchantment crept in. As the Soviet economy began to implode, an increasingly free press became the forum for rising criticism of the Energiya-Buran program. By 1993, the effort was in near shambles, with ground models of the Energiya and the Buran rotting away in various plants. In May 1993, the project's Council of Chief Designers requested a final decision from the Russian government.³ The project was formally shelved after seventeen years and 14 billion rubles. For the second time, thousands of Soviet space engineers saw their handiwork disappear into rubble. Many of those who witnessed the demise of the Energiya-Buran project were the same ones who had watched in silence at the abrupt termination of the N1-L3 program. Both projects had their own complex *raison d'être* and their own reasons for fall from grace, but both had one thing in common: they never fulfilled their original promise. The two projects together span the entire period of the piloted space program of the former Soviet Union. For those looking at waste of technology, of knowledge, of money, and ultimately of people, during the postwar Communist era, they need look no further than the N1-L3 and the Energiya-Buran programs.

The End of a Generation

Some would say that Vladimir Nikolayev Chelomey had a career worthy of a great Russian tragedy. After the cancellation of the N1-L3 program, his star seemed to rise for a brief period. In June 1974, he was elected as one of the approximately 1,500 deputies of the Supreme Soviet, the USSR's rubber-stamp parliament. While the legislature had no independent power in the country, membership usually indicated national prominence. In fact, Western observers scouring through the lists of the Supreme Soviet, upon finding Chelomey's name, believed that he was the "new head" of the Soviet space program, a "job previously held by . . . Yangel."⁴ For perhaps a couple of years, he may have also resurrected his ambitious UR-700M Mars landing project. He continued work on the Almaz military space station, two of which were launched between 1974 and 1976 as Salyut 3 and Salyut 5, respectively. He was evidently planning for a major expansion of activities at his design empire, planning much larger versions of Almaz stations serviced by the new Transport-Supply Ship. He even returned to one of his lifelong dreams—the development of an orbital spaceplane.⁵

3. *Utro*, Moscow Ostankino Television, First Channel and Orbita Networks, Moscow, May 25, 1993, 1845 GMT; S. Shamsutdinov, "First Flight of Buran With Tourists on Board Will Take Place on April 12, 1994" (English title), *Nouosti kosmonavtiki* 21 (October 9–22, 1993): 40–45.

4. Theodore Shabad, "Russians Indicate Rocket Specialist Heads Space Effort," *New York Times*, July 14, 1974, p. 6.

5. For the "resumption" of the UR-700M program, see Christian Lardier, *L'Astronautique Soviétique* (Paris: Armand Colin, 1992), p. 252. For the Almaz program, see Vladimir Polyachenko, "The 'Pep' of Almaz" (English title), *Krylya rodny* no. 4 (April 1992): 30–32; Olaf Przybilski, Almaz: Das supergeheime militärische Orbitaistationsprogramm der UdSSR (Dresden, Ger.: Institut für Luftfahrt, 1994). For advanced Almaz projects, see I. B. Afanasyev, "Unknown Spacecraft (From the History of the Soviet Space Program)" (English title), *Nouoye u zhizni. Nauke, tekhnike. Serya kosmonavtika. astronomiya* no. 12 (December 1991): 1–64. For the orbital spaceplane, see Anatoliy Kirpil and Olga Okara, "Designer of Space Planes, Vladimir Chelomey Dreamed of Creating a Space Fleet of Rocket Planes" (English title), *Nezavisimaya gazeta*, July 5, 1994, p. 6.

All of this simply proved too good to be true. In early 1976, one of Chelomey's chief sponsors, Minister of Defense Crechko, succumbed to a heart attack. Chelomey's opponents—primarily Clushko sponsors Ustinov and Kirilenko—reacted immediately. A few weeks after Crechko's death, they bestowed Glushko with an unprecedented honor that hitherto no designer in the space sector had ever held: membership in the Central Committee of the Communist Party. Clushko was officially "elected" at the 25th Communist Party Congress in 1976.⁶ As one observer noted: "From this moment onward, Clushko concentrated in his hands not only the power of an enormous space empire, but also the political power of a commissar, capable of overwhelming anyone in the space establishment." Clushko's first move was to deny Chelomey any role in the space station program. By 1978, to Chelomey's great alarm, the piloted portion of the Almaz program was terminated. Chelomey had no help from the Ministry of Defense, his usual supporters. They were of the opinion that piloted orbital platforms were less efficient for overhead reconnaissance than automated satellites."

The news just got worse for Chelomey. In 1976, Ustinov, as the new Minister of Defense, took it upon himself to complete the job he had set out to do more than a decade before. Ustinov:

methodically started to strangle Chelomey. He annulled all the military contracts given to Chelomey's enterprise for space flights: he canceled even those that were scheduled in unmanned mode and originally requested by the military.'

Perhaps the biggest blow to the Chelomey empire came on June 30, 1981, when Ustinov and Kirilenko pushed through an order that severed Chelomey's important Fili Branch from the main organization and instead made it a branch of NPO Energiya.¹⁰ Given that Chelomey had farmed almost all the key projects to this branch, then known as the Salyut Design Bureau (KB Salyut), he lost all his space- and missile-related projects in one fell swoop. Finally, on December 19, 1981, the Central Committee and the Council of Ministers issued a decree formally terminating not only all work on the Almaz program, but also forbidding Chelomey from any further involvement in the Soviet space program. The official reason for the decision was to "concentrate forces on the creation of the 'Buran' space system."

Brought to his knees by Ustinov, Chelomey quietly continued to develop naval cruise missiles for the armed forces, which was the original profile of his organization in the 1950s.

6 Two other chief designers in the defense industry were also elected to the Central Committee in 1976: P. D. Grushin from MKB Fakel (air defense and anti-ballistic missiles) and V. F. Utkin from KB Yuzhnoye (ICBMs, spacecraft, and launch vehicles). Grushin had been the first chief designer in the defense industry accorded this honor with his elections in 1966 and 1971. See Julian Cooper, "The Defense Industry and Civil-Military Relations in Timothy J. Colton and Thane Gustafson, eds., *Soldiers and the Soviet State: Civil-Military Relations From Brezhnev to Gorbachev* (Princeton, NJ: Princeton University Press, 1990), p. 168.

7 Roald Z. Sagdeev, *The Making of a Soviet Scientist: My Adventures in Nuclear Fusion and Space From Stalin to Star Wars* (New York: John Wiley & Sons, 1993), p. 209.

8 Maxim V. Tarasenko, "The U.S. and Soviet Space Systems Developments as Driven by the Cold War Competition," presented at the 45th Congress of the International Astronautical Federation, IAA 94, IAA 2.2.622, Jerusalem, Israel, October 9-14, 1994.

9 Sagdeev, *The Making of a Soviet Scientist*, pp. 209-10.

10 Yu. P. Semenov, ed., *Raketno-Kosmicheskaya Korporatsiya "Energiya" imeni S. P. Koroleva* (Korolev RKK Energiya, named after S. P. Korolev, 1996), p. 643. Nina Chugunova, "Chelomey's Cosmonauts: Why There Are No Crews From NPO Mashinostroyeniya in Outer Space" (English title), *Ogonek* 4-5 (January 1993), 24-29.

11 G. A. Yefremov, "Anniversary V. N. Chelomey—80 Years" (English title), *Novosti kosmonavtrik* 12-13 (June 4-July 1, 1994), 68-70. S. A. Zhiltsov, ed., *Gosudarstvennyy kosmicheskii nauchno-proizvodstvennyy tsentr imeni M. V. Khronicheva* (Moscow: RUSSLIT, 1997), p. 100. Chugunova, "Chelomey's Cosmonauts."

By all accounts, he never really gave up on his dreams of an ambitious space program, proposing various strategic defense programs throughout the early 1980s. He was not kind to Korolev's memory. In an interview with a journalist late in his life, Chelomey was blunt:

Well, what can I tell you about Korolev? Korolev was a man with a limited education. But he commanded a remarkable technical intuition and was enormously talented as an organizer. Yes. But he couldn't perform *even* a simple mathematical operation with integrals. He took the circumlunar [program] away from me and then he didn't do it himself. You call that talent?"

Ejected from the Soviet space program, Chelomey's will and his reach for success never diminished to his last days. In early December 1984, still in lively health, he was at his dacha, getting ready to go somewhere in his Mercedes. Leaving the car running, he walked out to open the garage door, but the car, still running, moved by itself and pinned his legs against the gate. He was admitted to the hospital with a simple fracture. While in the hospital, he learned that his nemesis Ustinov had suffered a massive heart attack, was paralyzed, and could not speak. Chelomey could be forgiven for believing that his fortunes were about to improve. On the third day in the hospital, on the early morning of December 8, he was speaking to his wife on the telephone when the conversation suddenly stopped. She desperately called the hospital staff, who rushed to his room to find him dead. Doctors suspected a sudden fatal stroke apparently caused by the broken leg. He was seventy years old at the time of his death. Legend has it that Ustinov was brought a piece of paper with a handwritten message stating "Chelomey just died." Ustinov read it and closed his eyes in satisfaction. The first name on the list of signatories of Chelomey's obituary was that of Ustinov."

Today, Chelomey's former organization is called the Scientific-Production Association for Machine Building (NPO Mashinostroyeniya) and is still located at its old grounds at Reutov outside Moscow. Having relinquished hold of its Moscow Branch in 1981, it has little connection to the Russian space program. Its current General Designer, Gerbert A. Yefremov, who succeeded Chelomey, continues to focus mostly on naval cruise missiles. Its only major space-related project is a continuation of the Almaz program—a robotic remote-sensing platform for Earth resources surveying. Three such spacecraft were launched—in 1986, 1987, and 1991—but despite Yefremov's best efforts, funding for a fourth is on a shoestring budget. By September 1994, the organization was in a severe financial crisis, planning to lay off thousands of employees.¹⁴ While the organization may have been in dire straits, Chelomey's legacy, in some ways, remains much more visible than even that of Korolev. Given that Chelomey had his Fili Branch produce most of his space work, the thriving nature of that branch has maintained Chelomey's long shadow across the current Russian space program. The Proton rocket, the Mir space station (derived as it was from the original Almaz design), and the Mir modules (such as Spektr and Priroda) all attest to a vision that has remained intact despite the best intentions of Ustinov or Glushko. If Chelomey were alive today, he might have some comfort in knowing that the first

12 Yaroslav Colovanov. *Korolev fakty i mify* (Moscow: Nauka, 1994), p. 724.

13. *Ibid.*, p. 729; Valeriy Rodikov. "Academician Chelomey and His Times" (English title). In V. Shcherbakov, ed., *Zagadki zvezdnykh ostrovov kniga pyataya* (Moscow: Molodaya gvardiya, 1989), pp. 35–36; "Vladimir N. Chelomei, Soviet Rocket Scientist," *New York Times*, December 15, 1984, p. 28; Christian Lardier, "Soviet Space Designers When They Were Secrets," presented at the 47th Congress of the International Astronautical Federation, IAA-96-IAA 2.2.09, Beijing, China, October 7–11, 1996.

14 I. Cherniy, "NPO Mash-nostroyeniya Reduces Staff" (English title), *Novosti kosmonavtiki* 20 (September 24–October 7, 1994) 49–50; Gerbert Aleksandrovich Yefremov, "NPO Mash-nostroyeniya's Moving Into the High-Technology Market" (English title), *Vooruzhenrye.politika. konversiya* 3(3) (1995): 31–37

element of the International Space Station, the Zarya Functional Cargo Block, is based on the design of the service module of the Transport-Supply Ship—a program that he pushed into approval in 1970. Zarya was designed, built, and delivered to NASA by the Khrunichev State Space Scientific-Production Center, a conglomerate of Chelomey's former Fili Branch (now called the Salyut Design Bureau) and the Khrunichev Machine Building Plant, established by governmental order on June 7, 1993.¹⁵

Chelomey's nemesis Ustinov had a meteoric career. With the exception of Korolev, Ustinov may have been the single most important individual in the emergence of the Soviet space program. At the same time, he is probably also the most overlooked. Scarcely mentioned in the Western historiography of the Soviet space program, Ustinov was at the center of the vortex of events of the Soviet space effort from 1946 to 1984, close to a forty-year span of time. Even in Russia, there have been no biographies of the man, nor is there evidence to suggest that he left personal memoirs. Of course, Ustinov's importance was not limited to the space program. He directly oversaw the tremendous growth and arrival of the Soviet Union as a formidable military player in world politics. Between 1965 and 1976, Ustinov was the Secretary of the Central Committee for Space and Defense, but he did not achieve his lifelong dream of entering the ranks of the Politburo until April 1976 with his appointment as the first Soviet civilian to serve as the Minister of Defense. His tenure at the post was a time fraught with unprecedented tensions with the United States, particularly over the Soviet invasion of Afghanistan and the Americans' stationing of Pershing missiles in Western Europe. He was reportedly in ill health in the early 1980s and was fast becoming a victim of Communist Party politics.¹⁶ Ustinov died on December 20, 1984, after a two-month illness at the age of seventy-six." In one of the bitterest of all ironies, his death came just twelve days after Chelomey had passed away. In an indication of new times, his death was first announced by Mikhail S. Gorbachev, considered at the time a fast-rising personality in the upper echelons of power. Not surprisingly, Westerners writing about his life's achievements at the time almost completely missed his contribution to the creation and sustenance of the Soviet space program."

Among the other heavy hitters of the Soviet space program, Leonid V. Smirnov, the former Chairman of the Military-Industrial Commission, served in that position from March 1963 to December 1985, managing the development and creation of several new generations of Soviet weaponry. During the reshuffling after Ustinov's death, Smirnov retired—the last of the powerful defense industry juggernauts who built up the military might of the USSR. Although still alive at the time of this writing, the eighty-three-year-old Smirnov has remained completely out of the public eye. His personal reminiscences would no doubt be a priceless asset to understanding Soviet motives during the Cold War.

Sergey A. Afanasyev, the Minister of General Machine Building—that is, the "space and missile" ministry.—served in that capacity from March 1965. After the death in 1976 of his chief sponsor, Minister of Defense Grechko, Afanasyev's star dropped rapidly. In April 1983, Ustinov finally had him fired. He was given the far less important job of Minister of Heavy and Transport Machine Building, which was a sector outside the defense industry. With his ambition of one day entering the ranks of the Politburo crushed, Afanasyev trudged through his new dreary job, before finally being forced to retire prematurely in July 1987.¹⁷ The "Big Hammer."

15 Zhiltsov, ed., *Gosudarstvennyy kosmicheskiy*, pp. 126-27

16. Sagdeev, *The Making of a Soviet Scientist*, pp. 258-59.

17 Serge Schmemmann, "Defense Minister of Soviet Union Is Dead at Age 76." *New York Times*, December 22, 1984, pp. i, 6

18 See, for example, Eric Page, "Ustinov Had Key Roles in Military and Politics." *New York Times*, December 22, 1984, p. 6

19 Sagdeev, *The Making of a Soviet Scientist*, p. 200.

as he was nicknamed by many in the space industry, has retained contacts with the Russian space industry as a "Chief Scientific Consultant to the General Designer" of RKK Energiya. In one of his very rare published memoirs of the space era, he had only favorable words to say of Ustinov, despite the obvious clashes between the two men.²⁰ At the time of this writing, he was eighty-one years old.

The Soviet space program had originated as an arm of the artillery sector of the Soviet armed forces, and as such, there were a number of important artillery officers who played prominent roles in guiding the entire effort. There was probably no one officer more important than Lt. General Georgiy A. Tyulin, whose involvement in the Soviet missile program began in 1944, when he was a young lieutenant charged with assessing German rocket technology. In March 1965, he was appointed Afanasyev's First Deputy in the Ministry of General Machine Building. During the 1960s, he served as the chair of various State Commissions, including those for the later Vostok missions, the Voskhod program, the L1 circumlunar project, and various lunar and interplanetary probes. He remained at his ministerial post until 1976, when, rumor has it, Afanasyev fired him for being part of the "Ustinov camp."²¹ Forced into retirement, the quiet and reticent Tyulin returned to teach theoretical mechanics at the M. V. Lomonosov Moscow State University.²² In 1987, he began writing publicly about his deep well of experience in the missile and space programs—articles that have been remarkably valuable in filling in the gaps of this secret history. After a long illness, he died in April 1990 at the age of seventy-five.²³

Tyulin was certainly better known than Vasiliy M. Ryabikov, who chaired the State Commission for Sputnik. One of the most mysterious figures in the early Soviet space program, Ryabikov was instrumental in the process of approving the first Sputnik launch. His early career was under Ustinov's shadow, but for a brief period in the 1950s, he emerged as one of the power players in the defense industry, only to disappear into relative oblivion. Almost nothing is known about his personal history. After his "ejection" from the defense industry, he served as the First Deputy Chairman of the State Planning Organ (better known as "Gosplan") until his death on July 19, 1974, at the age of sixty-seven. Even in recent years, Russian historians have generally shied away from any in-depth analysis of Ryabikov's role in the genesis of Sputnik. It is a curious omission for a man who may have facilitated the inauguration of the space era in 1957.

Of the two other major artillery officers from the space era, one remains alive. Lt. General Kerim A. Kerimov was demoted out of his ministry position in 1974, but remained the chair of the State Commission for Soyuz until 1991, a position he had assumed in 1966. He oversaw the launch of every single Soyuz spacecraft to the *Salyut* and *Mir* space stations during that period.²⁴ At the time of his retirement, he was officially the First Deputy Director of the Central Scientific-Research Institute for Machine Building (TsNIIMash), the leading research and development institution in the Soviet space industry.²⁵ At this writing, he was eighty-two years old. Lt. General Yuriy A. Mozzhorin, the powerful Director of TsNIIMash, remained in that post until December 1990, completing almost thirty years of service as one of the primary policymakers in the Soviet space program. He continued to be active in chronicling the history of the Soviet missile and space programs and served as editor of the series of memoirs titled *Dorogi v*

20. See Yu. A. Mozzhorin, et al., eds., *Dorogi v kosmos: I* (Moscow: MAI, 1992), pp. 34–48.

21. Sagdeev, *The Making of a Soviet Scientist*, p. 201.

22. Col. M. Rebrov, "Where the Cranes Fly" (English title), *Krasnaya zvezda*, September 19, 1987, pp. 3–4.

23. "G. A. Tyulin," *Krasnaya zvezda*, April 25, 1990, p. 4.

24. The only exceptions were some of the Soyuz T missions and all the Soyuz missions to the military Almaz space station.

25. *Russian Space History. Sale 6516* (New York: Sotheby's, 1993), description for Lot 58.

kosmos (Roads to Space), the first volume of which was published in 1992. He died on May 15, 1998, at the age of seventy-seven.

The Designers

All six members of the original Council of Chief Designers are deceased. Korolev, of course, was the first to go in January 1966. Academician Nikolay A. Pilyugin, Korolev's closest friend on the council, died on August 2, 1982, at the age of seventy-four, after a long bout with diabetes.²⁶ His obituary was signed by Brezhnev, Andropov, Corbachev, and Chernenko, all heads of the Soviet state at various points. Chief Designer Mikhail S. Ryazanskiy died after a long battle with cancer of the prostate gland on August 7, 1987. Academician Viktor I. Kuznetsov passed away four years later on March 22, 1991. The last member (aside from Clushko), Academician Vladimir P. Barmin, lived to the age of eighty-four, heading the organization he had founded until his death on July 17, 1993.²⁷ In one of his last interviews, Barmin waxed philosophical about the constraints of the Communist era:

... I have been working as a Chief Designer for more than fifty years, and have been "open" to the press only in recent years. My articles in the newspaper *Prauda* used to be under a pseudonym, Professor *Vladimirov*. . . .²⁸

Although he was not a member of the original council, General Designer Academician Nikolay D. Kuznetsov, responsible for creating the NI's rocket engines, played a major role in the rise and fall of the huge project. Despite Clushko's order to have all NI-related materials destroyed, Kuznetsov, at his own risk, preserved ninety-four engines of the first, second, third, and fourth stages at the storage facilities of the Trud Scientific-Production Association. All were completely ready for operational use. In addition, he also hid away fifty to sixty experimental units, ready for future developmental work. Kuznetsov's gamble paid off when in the early 1990s, major U.S. aerospace companies expressed interest in using the engines for the next generation of expendable U.S. launch vehicles. In late 1993, the Aerojet Propulsion Division imported a flight-ready version of the NK-33, believing the design to be of "very modern technology compared with what the U.S. has in LOX/kerosene engines."²⁹ In 1995, Kuznetsov's organization went head-to-head with Clushko's firm bidding for their respective engines on new versions of the Atlas or Delta rockets. Although Clushko's engines won that bid, the NI engines may still see the light of day.³⁰ In 1996-97, Kistler Aerospace Corporation of Kirkland, Washington, signed an agreement with Kuznetsov's former organization to use the NI's NK-33 and NK-43 engines on the company's K-1 reusable launch vehicle. In what could be a fitting legacy of the NI rocket, the first K-1 vehicle is expected to use the very same engine units that were meant for use on the canceled 8L launch of the NI in 1974.³¹ Sadly, Kuznetsov himself will not be witness to their use. At the age of eighty-four, he died on July 31, 1995.³²

26 "Academician N. A. Pilyugin," *Prauda*, August 3, 1982, p. 3; "Nikolai A. Pilyugin, 74, Dies: Was Key Soviet Space Figure," *New York Times*, August 3, 1982, p. A19.

27 "Academician V. P. Barmin," *Krasnaya zvezda*, July 22, 1993, p. 4.

28 V. Smirnov, "Topical Interview: Space Starts With the People on the Ground" (English title), *Aviatsiya i kosmonavtika* no. 10 (October 1992): 2-3.

29 Michael A. Dornheim, "Aerojet Imports Trud NK-33 Engine," *Aviation Week & Space Technology*, October 25, 1993, p. 29.

30 Dennis Newkirk, *Russian Space Review* 1996 (Roselle, IL: Dennis Newkirk, 1997).

31 V. S. Anisimov, T. C. Lacey, and J. Andrews, "Evolution of the NK-33 and NK-43 Reusable LOX/Kerosene Engines," presented at the 33rd AIAA/ASME/ASAE/ASCE Joint Propulsion Conference & Exhibit, Seattle, Washington, July 6-9, 1997.

32 "Academician N. D. Kuznetsov," *Krasnaya zvezda*, August 3, 1995.

The legacy of the NI also survives in the high-performance LOX-liquid hydrogen engines that were developed and tested in the early 1970s but were never used in flight. Most notable was Chief Designer Lyulka's I1D57 engine. The engine's production stopped in 1975 after 105 were built. During the testing period, the engine had accumulated more than 53,000 seconds of full-engine run time. In late 1993, Aerojet expressed interest in using the engine for its single-stage-to-orbit program." Chief Designer Isayev's I1D56, another LOX-liquid hydrogen engine developed for the NI, became the center of controversy in 1993, when the sale of the engine to the Indian Space Research Organization was blocked by the U.S. government, which had concerns over their potential application in military missile systems." After further negotiations, the Russian Federation delivered the first such engine to India in September 1998.

Although their names have not been prominent in Western histories of the Soviet space program, a number of men from the old Korolev design bureau played very critical roles in the road that led to Sputnik. Certainly from an engineering standpoint, there was no other individual more important in the genesis of Sputnik than Mikhail K. Tikhonravov. Overshadowed by the much more famous Korolev, Tikhonravov's role in the early space program was quite likely as important as that of his boss. With his landmark 1954 report on artificial satellites, he set off a process that ended with the launch of Sputnik in 1957. After Sputnik, Tikhonravov led the teams that designed the first piloted spacecraft, the first automated lunar probes, and the first Soviet reconnaissance satellites. He also contributed to policy by co-authoring important long-range plans for Korolev's design bureau. He continued work under Korolev, vigorously supporting piloted space exploration against those who believed in robotic exploration. He seems to have retired from the design bureau after Korolev's death and returned to teaching and writing. He died on March 4, 1974, at the age of seventy-four, after a spectacular career that had begun with his design of the first Soviet liquid-propellant rocket, the "09" in 1933. As with many other important individuals in Soviet space history, his life and his remarkable contributions remain drowned out by the flood of writings on Korolev. As a mark of respect to his memory, in February 1995, the Russian Military Space Forces renamed their leading space research institute, TsNII-50, after Tikhonravov.³³



Mikhail Tikhonravov was one of the most important engineers behind the emergence of the Soviet space program. He designed the first Soviet liquid-propellant rocket (in the 1930s), performed research to optimize early ICBM designs (in the 1940s and 1950s), and was the leading engineer behind the genesis of Sputnik. In later years, he was also instrumental in the design of the Vostok spaceship [files of Peter Gorin]

33. "Aerojet, Lyulka Push D-57 for SSTO Validation." *Aviation Week & Space Technology*, October 11, 1993, pp. 50-51.

34. Jeffrey L. Lenorovitz, "Space Systems/Loral Books Proton Launches." *Aviation Week & Space Technology*, September 20, 1993, pp. 90-91.

35. Valeriy Baberdin, "The Once Secret Space NII Will Now Bear the Name of Tikhonravov" (English title) *Krasnaya zvezda*, January 18, 1995, p. 6. TsNII-50 separated from the original military NII-4 on April 3, 1972, to focus exclusively on military space research as opposed to ballistic missile research.

With respect to the Korolev "high guard"—his key deputies—most have passed away. The *de facto* head of all piloted space programs at OKB-1 throughout the 1960s and 1970s, Konstantin D. Bushuyev, lived to serve as the director of the Soviet side of the Apollo-Soyuz Test Project in 1975. Although his true position, a Chief Designer at NPO Energiya, was kept tightly under wraps, he told his U.S. counterparts on one occasion that "he had started working with Korolev right after World War II. . . . Officially, during the entire joint project, he was forced to pretend that he was actually an employee of the Institute of Space Research under the USSR Academy of Sciences. This charade played out right up to his sudden death of a heart attack on October 26, 1978, at the age of sixty-four. He was apparently suffering from a toothache and was headed to the hospital when he suddenly dropped dead in a corridor. Unsure of how to facilitate the funeral of a figure in the Soviet space program whose identity was known before his death, Soviet officials chose the most ludicrous path. As one observer noted later: "After his death, instead of having a decent funeral at the former Korolev Design Bureau, where he had spent most of his active working life, the final sad ceremony was moved to the [Institute of Space Research], simply as a cover. . . ." ³⁷

As for the two "fathers" of the NI, Sergey O. Okhapkin died in March 1980 at age seventy. ³⁸ Given a different course of events in 1974, Okhapkin might very well have succeeded Mishin as head of the organization, because he had served as Mishin's First Deputy since 1966. The other NI designer, Sergey S. Kryukov, remains alive today, and he occasionally writes in the Russian media on the topic. He had one of the more interesting careers of any of Korolev's proteges. A few years after Korolev's death, on March 30, 1970, Kryukov left TsKBEM and joined the Lavochkin Design Bureau as the famous Babakin's First Deputy, thus turning his back on the NI and piloted spacecraft to focus on robotic probes. After Babakin's death, on August 26, 1971, Kryukov took over the design bureau and guided the organization through a mixed bag of lunar and interplanetary missions. Having become the victim of political maneuvering over a proposed Martian sample return project, Kryukov returned to his original place of work, then NPO Energiya. On November 17, 1977, he was appointed the First Deputy General Designer under Glushko. After overseeing the immensely successful *Salyut 6* space station missions, he retired in January 1982. ³⁹ Still a "scientific consultant" to Energiya, Kryukov, at the time of this writing, is eighty-one years old.

Of all of Korolev's deputies, perhaps the most well known is Boris Ye. Chertok. His career started with Mishin and Bushuyev at the famous Bolkhovitinov Design Bureau in the late 1930s. Chertok remained a powerful figure at Energiya through the 1980s, but he never rose to the top of the organization. Although he retired in 1991 from his official duties as Deputy General Designer, he continues to maintain his offices at the giant organization as a "Chief Scientific Consultant." Still full of verve and energy at the age of eighty-seven, Chertok recently admitted that "in the NI-L3 project we . . . made serious mistakes." ⁴⁰ He is one of the few men who, having lived through those historic times, has put pen to paper, and he is in the midst of publishing a multiple-volume set of priceless reminiscences. Incredibly detailed and remarkably devoid of partiality, these memoirs, titled *Raketi i lyudi* (Rockets and Men), cover everything from Chertok's early forays into Germany in search of A-4 missiles in 1945 to the

36 Edward Clinton Ezell and Linda Neumann Ezell, *The Partnership: A History of the Apollo-Soyuz Test Project* (Washington, DC: NASA Special Publication (SP) 4209, 1978), p. 288.

37 Sagdeev, *The Making of a Soviet Scientist*, p. 174.

38 Golovanov, *Korolev*, p. 480.

39 Yu. Markov, *Kurs na Mars* (Moscow: Mashinostroyeniye, 1989), pp. 25–26; Semenov, ed., *Raketno-Kosmicheskaya Korporatsiya*, p. 641. Note that the first source gives a slightly different date, December 1, 1977, as Kryukov's dismissal and subsequent appointment at NPO Energiya.

40 Peter Smolders, "I Meet the Man Who Brought the V-2 to Russia," *Spaceflight* 37 (July 1995): 218–20.

demise of the Energiya-Buran system during the early 1990s. Much more accessible than many other old-timers, Chertok continues to travel all over the world, including the United States, to speak of his life. He also has one foot in the future. His current project is a modest system of communications satellites in low-Earth orbit to serve the general populace.⁴¹

From the scientific community, there was probably no one individual who wielded as much influence as Academician Mstislav V. Keldysh, President of the USSR Academy of Sciences from 1961 and one of the most brilliant mathematicians of his generation. Unlike Korolev, Keldysh's personal contributions span the gamut from purely technical to purely managerial. During the 1950s, Keldysh personally participated and directed top-secret studies on the optimal design characteristics of multistage rockets, the question of returning a satellite from Earth orbit, the theory of passive gravitational stabilization of satellites, the calculation of various satellite orbits, and the mathematical analyses of optimal trajectories for flight to the Moon, Mars, and Venus. This research was performed at two institutions, both of which Keldysh headed simultaneously: the Department of Applied Mathematics of the V. A. Steklov Mathematics Institute under the Academy of Sciences and NII-1 under the Ministry of Aviation Industries. At the latter institute, Keldysh also initiated work on high-performance ramjet engines and nuclear rocket engines.

From 1961, after he was appointed to head the Academy of Sciences, Keldysh's most important contributions were as the chair of the Interdepartmental Scientific-Technical Council for Space Research. With Keldysh as chair, various permutations of this council served as "expert commissions" for several dozen different military and space programs.⁴² In 1975, Keldysh stepped down as President of the Academy of Sciences because of ill health. A man with a calm disposition who rarely, if ever, lost his temper, Keldysh's favorite form of relaxation was collecting *prints* of the Impressionists. He died on June 24, 1978, at the age of sixty-seven, sitting at the wheel of his car in the garage of his country home.⁴³ Keldysh's ashes were interred in the Kremlin Wall, an honor reserved for only the most revered Soviet citizens of this century. All fourteen members of the Politburo signed his obituary. Throughout his extraordinary life, there were probably few sectors of the Soviet military-industrial complex Keldysh did not influence with his scientific contributions or advisory activities.

Glushko

Academician Valentin Petrovich Glushko effectively headed the Soviet space program from 1974 for a fifteen-year period, and during that time, some would argue, there was almost a cult of personality surrounding his name. Glushko, having a hand in the editorial supervision of all books related to space exploration, made sure that his role and contributions to the development of Soviet space technology were placed in a favorable light. If in a 1957 speech at Korolev's fiftieth birthday, Glushko could say "Korolev occupies first place after Tsiolkovskiy" in the development of Soviet rocketry, he did not hesitate in later years to insert his name before Korolev in all histories of the Soviet space program." But with so much power, Glushko was still unable to carry out one of his most coveted dreams—piloted landing expeditions to the

41 *Ibid*

42 N. Chentsov 'World Famous But Secret in Every Way' (English title) *Nauka i zhizn* no. 2 (February 1991) 102-07. V. S. Avduyevskiy and M. Ya. Marov 'Mstislav Vsevolodovich Keldysh and Space Research' (English title) *Zemlya i vseennaya* no. 3 (May-June 1991) 46-52.

43 'M. V. Keldysh Dies: Mathematician Led Academy in Soviet' *New York Times* June 27, 1978.

44 For an interesting analysis of Glushko and his role in rewriting history see German Nazarov 'You Cannot Paper Space With Rubles: How to Save Billions' (English title) *Molodaya gvardiya* no. 4 (April 1990) 192-207. See also Sagdeev 'The Making of a Soviet Scientist' p. 182. For an edited version of his 1957 speech see A. Yu. Ishlinskiy ed. *Akademyk S. P. Korolev: ucheniy inzhener chelovek* (Moscow: Nauka, 1986) pp. 191-95.

Moon and Mars. At various points throughout the 1980s, he continued to bring this idea up to the Soviet leadership, but each time it was rejected. Knee-deep in the Energiya-Buran program, the Soviet military had little interest in funding another repeat of the N1-L3 debacle.⁴⁵

Despite Glushko's remarkable rise to prominence as the reigning emperor of the Soviet space program, he was still a man trapped within his times. Few photographs of him were published, and apart from the cursory details of his professional history, outsiders had no clue about his personal life. Recently, there has been a tendency to paint Glushko as some kind of evil player of the Soviet space program, the man who single-handedly destroyed the N1 program—first when he broke off relations with Korolev in the 1960s and second when he canceled the program in the 1970s. But this revisionism comes perhaps more from haphazard retroactive assessments than any in-depth analysis. While Korolev has been humanized by countless biographies, Glushko still remains an enigma—a man whose only motive, it seems, was to sabotage Korolev's dreams. Is it possible to bring Glushko down to the level of a human, flawed perhaps, but at the end of the day having the same ideals of space exploration as those of Korolev? He was apparently well versed in the finer arts, such as music, painting, and literature, was good at drawing, spoke fluently in five languages, and regularly kept up with non-scientific foreign journals. His deputies remember him as a man who had an "eye for style and flair for detail . . . he would always be elegantly dressed."⁴⁶ He was married several times. Apart from his clearly notable contributions to the space program, Glushko also spent years completing a forty-volume series for the Academy of Sciences on the topics related to rocket propulsion theory. Overall, he published more than 250 scientific works.

In 1989, Mikhail F. Rebrov, a Soviet military journalist acquainted with Glushko, wrote a very candid account of the general designer's life:

He was never weak nor banal — traits that frequently accompany material and professional success. As he himself said, his life was a long, difficult search which essentially consisted of attempting to reach the desired level of simplicity upon mastering incredibly complex designs. He apparently gave himself over fully to his life's main work, and was ready to sacrifice for it. But that was only the way things seemed. Where Korolev could at some point, after judiciously evaluating his capabilities, reserve the main strategic problem for himself, and turn some problems over to his students, Glushko did not let anything out of his hands.⁴⁷

Referring to the final years of his life, Rebrov wrote:

Nothing it seems could quench his thirst for activity, his frenzied passion to go down in history by completing what would come to be called "the first in the world." He was compared to the director of an enormous orchestra who was enchanted by the dream of playing something in such a way that would make the world talk about "the new Russian triumph in space." And, to a certain extent, he succeeded in this. . . .⁴⁸

⁴⁵ Glushko also tried to generate public interest in his Mars plans by writing in newspapers. See for example V. Glushko, Yu. Semenov, and L. Gorshkov, "Fantasy on the Drawing Board: The Road to Mars" (English title) *Pravda*, May 24, 1988, p. 3.

⁴⁶ Boris Katargin and Leonid Sternin, "Pushing Back the Missile Technology Frontiers," *Aerospace Journal*, no. 5 (September–October 1997), 88–90.

⁴⁷ Col. M. Rebrov, "Specific Impulse" (English title) *Krasnaya zvezda*, August 26, 1989, p. 4.

⁴⁸ *Ibid.*

The Korolev-Glushko fallout has been discussed much in recent years, but most accounts attribute this fracture to personal vendetta more than professional opinions. It seems more likely, however, that both men were acting perfectly within the bounds of their experience over the NI propellant issue, with Glushko supporting storables and Korolev cryogenics. Both men had solid reasons for their choices—rationales that had almost nothing to do with personality conflicts or outright hatred. The two had, after all, worked together through the Purges, through prison, and through the Stalinist era and maintained their cooperation. Recent accusations notwithstanding, there is no evidence to suggest that Glushko's testimony led to Korolev's imprisonment in the 1930s. In fact, both men acted with remarkable honor, given the exigencies of the day. Perhaps the tragedy of Glushko's life, if there is one, is that his ultimate ambition of being known as the most important person in the tapestry of the Soviet space program will never come true. He will always be behind Korolev, and he probably knew this fact very well. As early as 1968, a couple of years after Korolev's death, when a journalist asked Glushko about Korolev, Glushko replied. "But why are you always going on about Korolev! Korolev! And what was Korolev? He was just a thin metallic pipe. Inside it I placed my engines. Pilyugin—his instruments. Barmin put it on the launch pad and it flew. . . ." ⁴⁹

By the late 1980s, Glushko was seriously ill and partially paralyzed, to the point that a special stamp was made for him because he could not even sign his own name. While he was able to attend the first launch of his life's dream, *Energiya*, he was too ill to be at the Baykonur Cosmodrome for the launch of *Buran*. He continued working from his bed, asking for reports from his deputies on every little detail. In August 1988, knowing his days were numbered, he told one of his deputies that he wanted his ashes to be placed in an urn and kept in a safe place so that one day it may be taken to the surface of *Venus*.⁵⁰ Just fifty-six days after the first and last flight of the *Buran* space shuttle, on January 10, 1989, Glushko passed away in Moscow at the age of eighty." Even Gorbachev paid his respects. Thus ended the journey that had begun in 1923, when a fifteen-year-old boy had written to Tsiolkovskiy about rockets traveling in space.

Mishin

If Glushko is conventionally known as the man who sabotaged the NI program, then the popular retrospective evaluations of the contributions of Academician Vasiliy Pavlovich Mishin have been even less generous. One can almost randomly pick up any article on the history of the Soviet space program, and there will probably be a disparaging remark about Mishin. The hapless Mishin, after all, presided over the most ignominious period in Soviet space history. What better way to explain away all those failures than to attribute it to a short-tempered, impulsive, and unskilled manager who had a drinking problem? In all likelihood, there is probably much truth in the negative assessment of Mishin's role as a chief designer. He made some exceptionally poor decisions and pursued causes that collectively had seriously regressive repercussions on the effort as a whole. But like any figure in a complex history, his contributions were not one dimensional. In fact, quite possibly, his role has been demeaned unfairly.

After he was fired in May 1974, Mishin declined to take up Brezhnev's offer to help find a job, and he returned to full-time teaching at the prestigious Moscow Aviation Institute, his alma mater. He had originally founded the Cosmonautics Faculty at that institute in 1959 and taught

49. Colovanov, Korolev. p 707.

50. Semenov, ed., *Raketno-Kosmicheskaya Korporatsiya*. p. 434, Katorgrn and *Sternin*. "Pushing Back the Missile Technology Frontiers " Note that in the latter source, the authors state that Glushko wanted his ashes taken to the Moon or Mars.

51. "Academician V. P. Glushko." *Pravda*, January 13, 1989, p. 8; "Valentin Glushko. 80. Rocket Pioneer for Soviet Program." *New York Times*, January 13, 1989, p. B5.

on a part-time basis for fifteen years. After his dismissal, he went back only once to his old design bureau, as part of a project to document Korolev's scientific heritage. While he was no longer involved in the mainstream Soviet space program. Mishin continued to pursue an academic career focused on space technology. As part of his teaching, he directed a design project that led to the creation of the *Radio-1* and *Radio-2* amateur communications satellites." His name was, of course, never mentioned in any histories of the period. Clushko apparently wished to remove Mishin from history. Although he was allowed to publish under his own name. Mishin wrote only technical books or contributed to historical works without being able to admit his own personal role in any space or missile project."

His relatively obscure existence was interrupted dramatically in 1985 when the KGB abruptly summoned him for questioning about his relationship to a journalist named Suslov who had interviewed him. The KGB agents told him that Suslov was under arrest on charges of passing Soviet secrets to the West: they believed that Mishin was his accessory and threatened to strip him of membership in the Communist Party and put him on trial. The KGB finally dropped the case when they could not find evidence to implicate Mishin. He had simply been one of the people Suslov interviewed."

Given that Mishin was not allowed to talk about his role in the history of the Soviet missile and space program, few people in the West were even aware of his significant role. His name was first mentioned by a Soviet emigre in 1982 and later by a French journalist in 1985, but most Western analysts remained unconvinced, believing that it was Yangel or perhaps Chelomey who had succeeded Korolev in 1966." As the new era of *glasnost* ("openness") dawned on the Soviet Union during the mid-1980s, it slowly opened up the cellar doors of long-forgotten tales. A nation began to rewrite its history. In 1986, journalist Yaroslav K. Colovanov was allowed, by special clearance of the Central Committee, to write on the original group of cosmonauts. In a six-part article in the official Soviet newspaper *Izvestiya*, Colovanov revealed the events behind Gagarin's historic mission.⁵⁶ Among the more tantalizing revelations were the names of all twenty men who had been selected as cosmonauts in 1960. Until then, Soviet censors had allowed the publication of only the twelve who had flown into space.

Unflown cosmonauts were not the only ones who benefited from this free exchange of information. In late 1987, as part of celebrations for the thirtieth anniversary of the launch of the first Sputnik, the Soviet astronomy and space journal *Zemlya i usemennaya* (*Earth and Universe*) published a short article by Mishin in which he openly revealed that he had succeeded Korolev." *Glasnost* may have meant openness, but Glushko made sure that there was no talk of the piloted lunar program, for to admit such a history was to admit that not only did the USSR race the United States to the Moon, but that it had lost. It finally took Glushko's death in January 1989 to change the climate. In July 1989, a relatively obscure newspaper named *Poisk* (*Search*) published a short article consisting of a few diary entries from the personal journal of Air Force General Nikolay P. Kamanin. There was no ambiguity in his writing: the Soviet Union had had a piloted lunar

52 Jacques Villain ed *Baikonour la porte des étoiles* (Paris Armand Colin 1994) p 136

53 Two of his books from the 1970s and 1980s are V P Mishin *Vvedeniye v mashinnoye proyektirovaniye letatelnykh apparatov* (Moscow Mashinostroyeniye 1978) and V P Mishin *Osnovy proyektirovaniya letatelnykh apparatov* (Transportnyye sistemy) (Moscow Mashinostroyeniye 1985)

54 Mikhail Rebrov 'The Last Argument A Study of the Designer in Black and White' (English title) *Krasnaya zvezda* March 25 1995 p 6

55 For the emigre see Victor Yevisikov *Re Entry Technology and the Soviet Space Program (Some Personal Observations)* (Falls Church VA Delphic Associates 1982) For the French journalist see C Wachtel 'The Chief Designers of the Soviet Space Program' *Journal of the British Interplanetary Society* 38 (December 1985) 561-63

56 The articles were titled "Cosmonaut No 1" and were published between April 2 and 6 1986

57 "Our Interviews' (English title) *Zemlya i usemennaya* no 6 (November-December 1987) 2-5

program, timed to compete with Apollo.⁵⁸ The following month, veteran cosmonaut Valeriy F. Bykovskiy, one of those who had trained for the project, admitted the same thing in his just-published biography.⁵⁹ These two publications burst the floodgates. Within weeks, there was a major in-depth article in *Izvestiya* on the N I program, and by October 1989, Mishin gave a long interview on the project, covering his role as one of the pioneers of the Soviet space program.⁶⁰

In this and subsequent interviews, Mishin did not hide his bitterness at having been wiped from the history of the Soviet space program. He took aim at Clushko, Ustinov, and all the other individuals who had silenced him for fifteen years. He also did not have kind words for the current Soviet space program:

Very little has been done about what we thought about and dreamed about 20 years ago, even 30 years ago with Korolev. It is simply vexing that so few useful and efficient space vehicles are in Earth orbit. . . we have become addicted to the long, monotonous long-duration manned missions in the tight Salyut-Mir which repeat each other. It is uery wasteful.⁶¹

When asked how there could be a vigorous forward-looking space program, he replied:

Space exploration has been hampered by monopoly and secrecy, and by nepotism and politically dealing in the allocation of buildings and subsidies. We need broad, open competition in projects for a unified technical task. And discussion of tasks, ideas, and proposals, and independent expert evaluations, and open selection of the winners. Only after this, in full view of everyone, should there be implementation of projects in which the whole of society is convinced of their need and soundness.?

He might as well have been talking of an alien world as compared to the Soviet system. Mishin also added his own two cents to the emerging debate over whether if Korolev had lived, the Soviets might not have had more success in their ventures into space:

. . . in the main thing, in the desire to create a well-considered strategy for space exploration, we were. I hope, fellow thinkers. No. I probably did not possess the kind of will and sharp tongue that distinguished Korolev. I am prepared to admit that. But in our space situation, the replacement of one character for another and the replacement of leading personalities did not play any decisive role."

In the initial flurry of publicity concerning the Soviet Union's aborted piloted lunar program, Mishin wrote extensively and granted many interviews, but in recent years, he has remained out of the public eye, except to occasionally author pieces paying tribute to his mentor, Sergey P. Korolev. The latter clearly had a very high regard for Mishin, having picked the thirty-year-old Mishin to serve as principal deputy in 1946. Korolev told a journalist once:

I found this to be true and recurring regardless of circumstances, every now and again, all of a sudden a man would come from out of nowhere, from the great unknown, a

58. Lev Kamanin. "From the Earth to the Moon and Back" (English title). *Poisk* 12 (July 1989) 7-8

59. Grigoriy Reznichenko. *Kosmonaut-5* (Moscow Politicheskoy literatury, 1989). p. 98

60. Sergey Leskov. "How We Didn't Get to the Moon" (English title). *Izvestiya* August 18, 1989, p. 3. A Tarasov. "Missions in Dreams and Reality" (English title). *Prauda*, October 20, 1989, p. 4

61. Tarasov. "Missions in Dreams and Reality "

62. *Ibid*

63. *Ibid*

man that would be remarkable precisely for the qualities you sought: he is gifted, courageous, honest. . . . He would introduce himself, extend his hand in a trustworthy manner, modestly speak of the work he has done, and a miracle would happen, the unknown is no longer the unknown. And then you would say to yourself: "This is he, precisely the man I need."⁶⁴

He was evidently speaking of Mishin.

Perhaps wanting his story to be told. Mishin put his personal diaries — thirty-one volumes covering the period from 1960 to 1974 — up for sale at a special auction of Soviet and Russian space artifacts at Sotheby's in late 1993.⁶⁵ The Perot Foundation purchased the diaries for \$190,000. Unfortunately at the time of this writing, the institution has yet to make these priceless writings available to scholars. Portions have been exhibited as part of the National Air and Space Museum's "Space Race" exhibit opened in 1997. Mishin himself continues to teach at the Moscow Aviation Institute, having just turned eighty-two. He wrote perhaps the best epitaph to his own contribution to the Soviet piloted lunar program in a monograph he authored in 1990 on the N1-L3 program:

I do not want the readers to think that I am trying to relieve myself as Chief Designer of responsibility for certain errors committed (including by me personally) during work on the lunar program. Only he who does nothing makes no mistakes. We, the successors of S. P. Korolev, did everything we could, but our efforts proved to be *inadequate*.⁶⁶

64 Rebrov "The Last Argument"

65 *Russian Space History Sale 6516* (New York: Sotheby's, 1993) description for Lot 29. John Noble Wilford "Soviet Space Papers Going on Sale" *New York Times*, December 5, 1993, p. 36.

66 V. P. Mishin "Why Didn't We Fly to the Moon?" (English title) *Znaniye tekhnike seriya kosmonavtika astronomiya* no. 12 (December 1990) 3-43.



CHAPTER TWENTY

CODA

For a brief period in the late 1950s and early 1960s, one could reasonably argue that the Soviet Union was the leading spacefaring nation in the world. In the light of the ultimate demise of the Soviet empire, however, thinking of the USSR as launching humanity's first steps into the cosmos seems a strange abstraction—the memory feels oddly empty, almost irrelevant perhaps. When we do remember, we tend to divorce Sputnik from its origin as a uniquely Soviet artifact—an eighty-four-kilogram sphere that was designed and built by men who lived through a war in which their country lost more than 25 million people, experienced the terror of Stalinist times, and defined themselves as Communists. Instead, we focus overwhelmingly on the impact of Sputnik rather than the construction of the artifact itself. I do not mean to suggest that meanings are unimportant. But in privileging only Sputnik's impact, we have told only half the story. Certainly, this is partly because the Soviet space program was given birth—and given flight—behind closed doors. Peeking through the now opened curtains, what I have tried to present here is an account of the missing half of that tale. This is only one version of the story, and certainly not the only one. But in sifting through the evidence and constructing the narrative, three broad themes have served as guidelines.

The first theme has to do with the institutional framework and the interplay among different factions within the Soviet space program and its antecedent missile project. Four primary constituencies were fundamental to establishing a Soviet ballistic missile program in the 1940s and 1950s. They were the engineers, the artillery officers, the defense industrialists, and the Communist Party. Each faction had its own agenda, but for a period of about fifteen years following the end of the war, their motivations intersected at crucial points to give rise to the world's first space program. The engineers were driven by their somewhat idealistic dreams of exploring space—dreams that had taken flight when they were young rocketry enthusiasts in the 1930s. The artillery officers were in need of a new generation of strategic weaponry to transform their backdated service into a powerful deterrent force. The defense industrialists had the not inconsiderable task of expediting the development of a strong military. And the Party leaders—in particular Stalin and Khrushchev—were driven by the political exigencies of the Cold War to direct the three other factions to elevate the Soviet Union from a nation afraid to defend itself to one that could threaten with offense.

The collusion of these four groups was necessary for the development of the world's first intercontinental ballistic missile, the R-7. This missile, of course, was simply a military weapon—a tool for mass destruction. In the hands of one visionary—Sergey Pavlovich Korolev—it became something entirely different. In the unlikely marriage of military imperative and idealistic ambition, the R-7 missile fired the first salvo in the space era—not by exploding a nuclear warhead, but by sending a small ball of metal around Earth on October 4, 1957. A

country that had been dismissed as a nation of farmers and factory workers had suddenly arrived on the world's stage with an achievement that was too impressive to ignore.

There was more to come. Within four years, using the same rocket that had launched Sputnik, the Soviet Union, now armed with a new tint to the old socialist doctrine of harnessing technologies in the interest of the state, reached the apotheosis of its dizzying trajectory into the heavens. Historian Walter A. McDougall, writing in the introduction of his seminal work, . . . *the Heavens and the Earth*, compared the event to the migration of the fish Eusthenopteron from the seas to the land:

In A.D. 1961 Homo sapiens, in turn, left the realm of solids and gases and lived, for 108 minutes, in outer space. Life again escaped, or by definition extended, the biosphere. The earth's crust and canopy of air became another platform to a new universe as infinite as soil and sky must have seemed to Eusthenopteron.'

Only the vicissitudes of history will decide whether the flight of Yuriy Alekseyevich Gagarin in the spaceship Vostok will be remembered with such sweeping comparisons in the centuries hence. Even as the decade of the 1960s passed through tumult and chaos, humankind's first trip into space began to recede into the background. By the time that the first humans landed on the surface of the Moon in 1969, Gagarin's flight had been eclipsed in the popular conception of space exploration by the spectral images of two American men who left their footprints on another planetary body. The technology, the men, the pictures, and even the parades seemed so much more compelling to a new generation. In the historiography of space exploration, Gagarin's excursion assumed more importance for how it affected the American decision to aim for the Moon than for its own place in the history of human evolution.

But Gagarin's flight, both from a historical and a technological perspective, warrants more scrutiny. This is not only because it was achieved by a nation that was not expected to do so, but, simply and ultimately, because it was, as McDougall pointed out, an event that, like perhaps Apollo 11, transcended nations, languages, cultures, and continents and, for 108 minutes, represented the planet Earth: for the first time since the origin of life on this planet, one life form had managed to escape it. At the same time, we should not minimize more earthly considerations. Gagarin's flight did not, after all, happen in isolation from the political, economic, and social dimensions of the Cold War. And ironically, as this book has shown, the same forces that allowed the Soviet Union to send the first human into space—the need to arm themselves with powerful new weapons—deprived the country of further national triumphs in the space race.

Considering the post-Gagarin era leads to the second major theme of this work: the Soviet effort to beat the United States in landing the first person on the Moon. After an unprecedented catalogue of firsts in the late 1950s and early 1960s, the Soviets failed dismally in this quest. The road to failure began almost as soon as Gagarin had floated down in his parachute. After 1961, the Soviet space program, jostling for a role in the new Soviet military technocracy, began to stumble and slide in trying to attain a stable position of growth. Different factions were all vying for the same piece of pie. The artillery officers, now subsumed under the Strategic Missile Forces, increasingly declined to fund the primarily civilian endeavors of the human space program. The military, it seems, was more interested in missiles than the Moon. Grand visions of space exploration, as the one Korolev proposed in 1960, died under their own weight as the military siphoned off funding from important space projects in favor of developing a new generation of strategic weapons systems. Because their primary job was to design intercontinental

1. Walter McDougall, . . . *the Heavens and the Earth. A Political History of the Space Age* (New York: Basic Books, 1985), p. 3.

ballistic missiles, the main space design organizations had to sacrifice ambitious space plans on the altar of strategic necessity. The Cold War, having given birth to the Soviet space program, would seriously threaten its very existence. In this climate, important avenues of research, such as the development of high-energy cryogenic rocket engine technology, never reached beyond the exploratory stage.

Despite the visible firebrand rhetoric of Nikita S. Khrushchev in the early 1960s, his support of a coherent long-range civilian space program was lukewarm at best. In 1961, when U.S. President John F. Kennedy laid down the challenge of reaching the surface of the Moon prior to the end of the decade, the Soviet space leadership hardly took notice. Organizational chaos emerged as a flurry of competitors began to dilute the hard-earned gains of the space program. The engineer faction, so united at the time of Sputnik, began to fragment in the face of limited funding. Between 1961 and 1964, Korolev ran his program on a shoestring budget, as proposal after proposal ended up in ministry file cabinets, never to be seen again. In desperation, he mounted two hastily prepared spectacles in the mid-1960s—missions that had no value other than to please the Party leaders: the launch of the first multicosmonaut crew in 1964 and the accomplishment of the first spacewalk in 1965. The diversion cost the Soviets dearly. It was only in 1964 that Khrushchev sanctioned a piloted lunar landing program, three years after Kennedy's own challenge. The commitment itself was never followed up as the military continued to withhold funding, prompting the engineers to omit crucial phases in the ground testing of their lunar rocket. The shortcuts inexorably led to the series of crushing failures just as the United States was landing its first citizens on the surface of the Moon.

With the loss of the Moon race in 1969, the Soviets diverted much of their resources in the following years to space station programs. Korolev's successor, Vasiliy Mishin, has argued in recent years that despite the success of Apollo, there was no cause to abandon the massive N1-L3 lunar program simply because the Americans had arrived at the Moon first. As sound as this logic seems to be, engineers in the 1970s had to deal with a political climate that was vehemently hostile to expensive civilian programs such as lunar missions. Soviet leaders saw little need for such projects, because their success would raise inevitable questions about the original failure to beat Apollo.

The third and final theme of this work addresses the manner in which the Soviets handled technological innovation in the space program. The evidence both confirms and counters our a priori conceptions of Soviet technology as one characterized by evolutionary rather than revolutionary changes. In the space program, the Soviets used a combination of both: the decision to forego the former in favor of the latter often had as much to do with accident as with political expediency. For example, having built the first piloted spaceship Vostok by 1960, the Soviets tried hard to extend its capabilities by introducing relatively minor changes that cumulatively added to moderate gains. They abandoned Vostok as a viable piloted spaceship only in 1966 when they absolutely had to—that is, when the Soyuz spacecraft, which represented a qualitative leap in design and performance, was virtually ready. The decision to fly one over the other in 1966 had as much to do with the impossibility of fulfilling contemporary objectives in space with the Vostok as with the fact that flying the Vostok (or its surrogate Voskhod) in 1966 would have demonstrated a visible and obvious lag to U.S. space technology.

In the thirty-year period spanning from 1945 to the mid-1970s, I looked at two cases of technological leaps: the R-7 ICBM and the N1 Moon rocket. Both projects required immense coordination in scale and scope across a Byzantine state-controlled landscape of research, development, and production. The success of the R-7 resulted not only from the high degree of financial commitment afforded by the state, but also because of the use of unorthodox management institutions such as the Council of Chief Designers. For example, in 1952, when Korolev decided to skip an intermediate stage in missile development and move directly to the ambitious ICBM project, the council proved to be a key and influential forum through which he

could substantiate the proposal and ultimately convince the Soviet government of its feasibility. The council also served as an unusual managerial mechanism that allowed chief designers to intervene at key points in the development of the ICBM. Ultimately, the Council of Chief Designers managed to circumvent the internal self-generated inertia of Soviet industry, which discouraged major technological leaps and favored short-term gains.

In his important study on the origins of the Soviet atomic bomb, *Stalin and the Bomb*, David Holloway concluded that "[a]fter Stalin's death, nuclear scientists . . . enjoyed unprecedented authority among the political leaders." The evidence from the space program suggests that the privilege of authority granted to the nuclear scientists was eventually expanded to include the engineers who played influential roles in the rise of the Soviet ballistic missile program. Although Western observers have long thought that it was Sputnik that changed the fortunes of these engineers such as Korolev and Glushko, their relationship to the political leadership changed more than a year before Sputnik with the successful test of the first Soviet strategic missile, the R-5M. The landmark test dramatically escalated the space engineers' leverage with both the Communist Party and the government and eventually led to the formation of a loose coalition of designers who would wield considerable power and influence. Although after 1960 they rarely, if ever, acted as a united front, the missile and space designers represented a formidable constituency that profoundly affected the direction of space policy beginning the late 1950s.

Because the Soviet political leadership lacked a clear understanding of the new technologies of the missile and space program, they needed the engineers to actively participate in policy formulation. The chief designers obliged willingly by forming lobbies, and, in the process, they acquired sufficient power to oppose important mandates from the top. There should be no confusion as to how the designers attained their powerful positions—it was not space, but rather their contribution to missile development that empowered them. Because the space program was largely a byproduct of missile production, the privileges almost by default were extended from the latter to the former. Both Nikita Khrushchev and Sergey Korolev played key roles in this process: Khrushchev because he allowed the rise of a constituency, and Korolev because he strongly pushed for it. But as the powerful chief designers vied for limited resources, they began to abuse the patronage system through various contacts within the Central Committee. "The favor of not even Khrushchev, Brezhnev, or Ustinov, but of a totally forgotten Central Committee agent," one Russian journalist wrote, "could determine the prospects for the development of the highly complex [space] sector for years." The chaos was one of the key factors in the failure of the NI program.

Korolev did not live long enough to witness the ultimate decline of the juggernaut he helped create. He did, however, leave behind an unmatched legacy—one that continues to be debated more than thirty years after his death. Most historians, both in Russia and in the West, have not argued with the holy grail of the history of the Soviet space program: that Sergey Pavlovich Korolev was its founder and central motivator. Given what is known about the vortex of events surrounding the launch of both Sputnik and Gagarin, it would be hard to dispute that claim. But at the same time, there has been an eagerness to attribute to Korolev roles that he clearly did not play, at least in his later life. It is particularly noteworthy that Sergey Korolev, the person who was most responsible for Sputnik was neither a scientist nor an engineer, but rather a manager with a vision. Boris V. Raushenbakh, one of Korolev's close associates from the 1960s, later wrote:

2 David Holloway, *Stalin and the Bomb: The Soviet Union and Atomic Energy, 1939–1956* (New Haven, CT: Yale University Press, 1994), pp. 366–67.

3 S. Leskov, "'Salyut-7' Is Falling: No One Knows Where and When" (English title), *Izvestiya*, January 18, 1991, p. 8.

Sometimes one hears it said that Korolyov was an excellent engineer and scientist. *It* is difficult to agree with this *if* the terms "engineer" and "scientist" are accorded their usual meaning. Korolyov himself did not devise any especially interesting solution to a complicated structural problem, as is the case with brilliant engineers. He was also not a scientist in the usual sense of the word: his name is not linked with any original scientific theory or with any prolonged and extensive study of a complicated phenomenon. However, these statements are not to be construed as a deprecation of the role which he played in the birth of space travel. There are many outstanding scientists and engineers, and Korolyov is a unique *individual*. His uniqueness, moreover, is linked to the fact that he was to introduce a new era into human history: the space *age*.⁴

The rise of the Soviet space program was one of the most significant processes in the history of science and technology in this century, not only because it opened what Raushenbakh calls "the space age," but also because it had profound sociopolitical consequences all over the world. Within the context of the Cold War itself, the Soviet space effort was a benchmark—a milestone that turned history from one path to another. For the first decade after Sputnik, the space *age* was indistinguishable in many ways from the space race. As the breadth of retrospect grows longer and longer, the import of the latter—that is, the space race—will no doubt recede far into the background, as perhaps it should. But for a short period in this century, the race provided the impulse for humankind to depart from this planet and reach the Moon. The Soviets, of course, lost this race, although they managed to throw shreds of doubt onto the victor's parade by denying that they had even signed up for the event. This deception existed for more than two decades, and when the truth was finally revealed, few took notice.

In 1999, during the thirtieth anniversary of the landing of humans on the surface of the Moon, the memory of Apollo spurred a brief but important resurgence of the sense of wonder and fascination that humans attach to space exploration. But lost amid the reevaluations and archaeology digs through Apollo, perhaps the greatest technological adventure of humankind was the other side of the coin—the story of those who had given reason to embark on Apollo in the first place. Buried under history was Korolev's "last love," the N1 program. That the N1 program was consigned to the status of a footnote is not so unusual: history has a way of privileging successes over failures. Our understanding of this dichotomy, between success and failure, is intrinsically tied to a second one—that between inevitability and contingency. On the one hand, we tend to see an inevitability in history's trajectory to the present—for example, that given the set of prevailing circumstances, the N1 program had to fail and that Apollo had to succeed. On the other hand, the story is compelling precisely because the outcome was not inevitable—that is, it was contingent on thousands of circumstantial factors. The tension between contingency and inevitability has contributed much to the enduring myths we now associate with the race to the Moon. The story of the Soviet space program has long been part of that myth. We have tended to see Soviet successes in space (such as Sputnik) as contingent and Soviet failures (such as the N1) as inevitable. This myth, it seems, is far too simplistic and takes away from the genuinely worthy accomplishments of Sputnik and Gagarin. The myth served its purpose during the Cold War, but now with the collapse of the Soviet Union and the opening of the Russian archives, it is finally time to put it away.

4. Boris V. Rauschenbach. *Hermann Oberth: The Father of Space Flight* (Clarence, NY: West-Art, 1994).
p 172

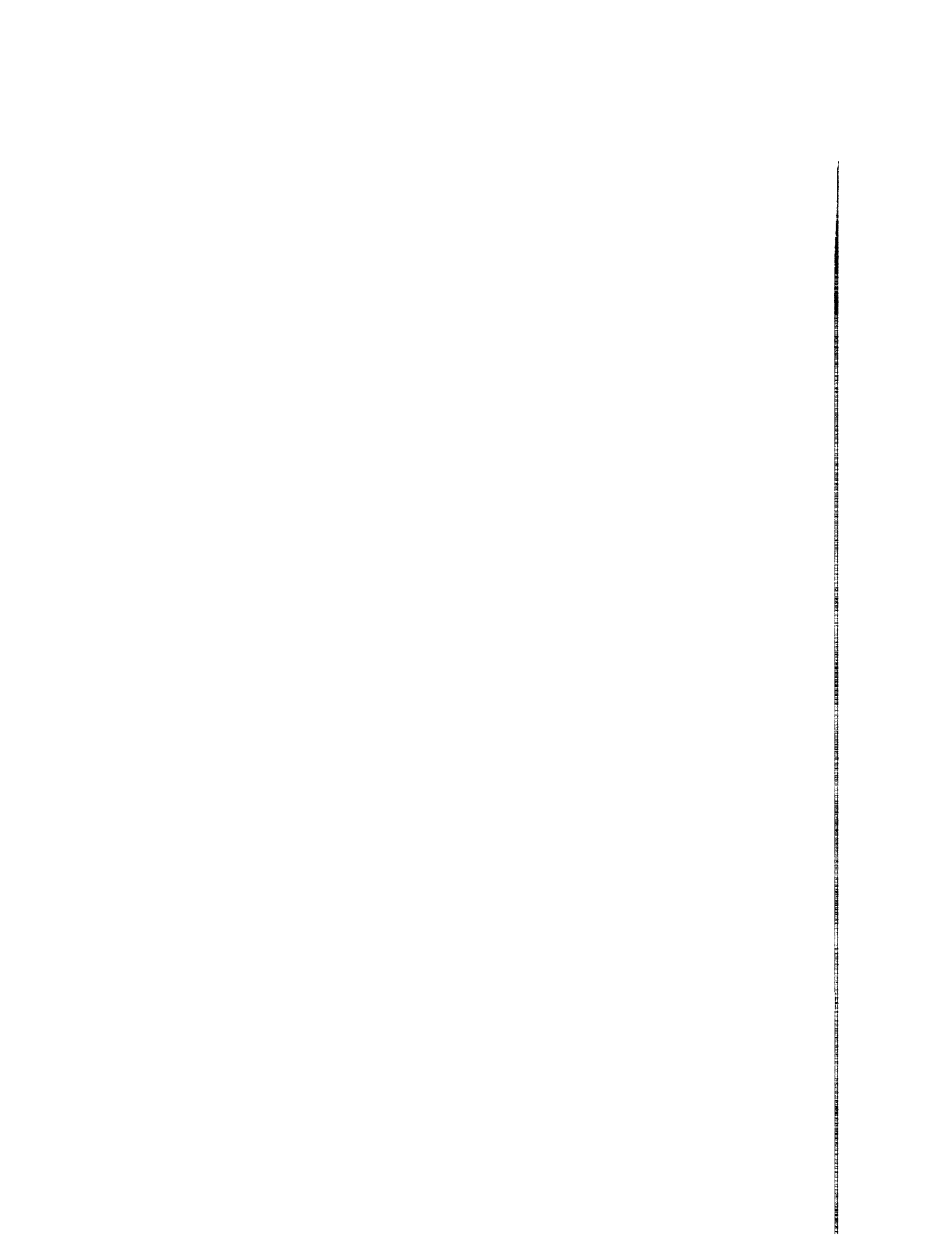

BIBLIOGRAPHIC ESSAY

Writing a history of the Soviet space program poses some interesting historiographical challenges in terms of source selection. As much as possible, I have tried to rely on Russian language sources. With very little exception, Western literature on the history of the Soviet space program has been a hodgepodge of speculation and sensationalism. Problems abound within Russian-language literature. Almost everything published prior to about 1988 was filtered through the Soviet censorship apparatus; details were sparse, and accounts often filled with inaccuracies. A major problem in the post-1988 literature is the dearth of primary sources. All archival sources, both at the governmental and Communist Party levels as well as within specific design bureaus, remain off limits to Western researchers.

Almost all of the Russian-language books and journals I have listed below are available at the Library of Congress in Washington, D.C. Others are available at libraries with large Russian-language collections, such as the University of Pennsylvania, the University of Pittsburgh, the NASA Headquarters Library, the NASA History Division archives, and the University of Massachusetts-Amherst. Many articles from the Russian media have also been translated into English by the Joint Publications Research Service (JPRS) under the JPRS-USP (Central Eurasia: space), JPRS-UAC (aviation and cosmonautics), and the JPRS-UMA (Soviet/Russian military affairs) titles. The JPRS apparently discontinued the first two series by 1995. Space articles are now continued under the JPRS-UST (science and technology) series. I would encourage all researchers of Soviet space history to begin with the JPRS issues, especially those covering 1988-95. All JPRS issues are available at the Library of Congress in both paper and microfiche forms. Most large university libraries also carry the entire series on microfiche.

I have used a combination of eight different types of materials to piece together this narrative:

Primary documents that have been published as collected works by Russian historians with access to archives

2. Official histories from Soviet-era space organizations
3. Biographies of major participants of the Soviet space program
4. Oral histories and memoirs from veteran participants of the Soviet space program
5. Articles and books by historians of the Soviet space program
6. English-language sources
7. Declassified documents
8. Interviews and correspondence

Primary Russian Documents

Falling into the first category, four works were invaluable as the backbone of this current work. The most important of these was *Tvorcheskoye naslediyе Akademika Sergeya Pavlovicha Koroleva: izbrannyye trudy i dokumenty* (The Creative Legacy of Academician Sergey Pavlovich Korolev: Selected Works and Documents) (Moscow: Nauka, 1980), collectively edited under the leadership of Academy of Sciences President Mstislav Keldysh. This particular book is a collection of many of Korolev's technical works spanning 1930 to 1965. What the book suffers in terms of Soviet-era censorship is more than compensated by the remarkable breadth of materials. A less than stellar English translation of this book is available at the NASA History Division as prepared by the Translation Division of the Foreign Technology Division at Wright-Patterson

Air Force Base in Ohio. The translation reference number is FTD-ID(RS)T-0504-81; it was issued on September 3, 1981. The main compiler of the Russian-language work was Georgiy S. Vetrov, a historian at RKK Energiya who died in October 1997. At the time of his death, he had completed a second complementary volume of similar documents titled *Korolev i yego delo: svet i teni v istorii kosmonavtiki* (*Korolev and His Works: Light and Shadows in the History of Cosmonautics*), which was published by the Nauka publishers in Moscow in mid-1998. This volume contains many documents on secret programs that could never have been published during the Soviet era. Unfortunately, I was only able to make minimal use of Vetrov's new work because my own manuscript was already completed at the time of its publication.

There are two other book-length works that are collections of primary documents. They are V. S. Avduyevskiy and T. M. Eneyev's *M. V. Keldysh: izbrannyye trudy: raketnaya tekhnika i kosmonautika* (*M. V. Keldysh: Selected Works: Missile Technology and Cosmonautics*) (Moscow: Nauka, 1988), and B. V. Raushenbakh's *Materialy po istorii kosmicheskogo korabl "uostok"* (*Materials on the History of the "Vostok" Space Ship*) (Moscow: Nauka, 1991). I would recommend the latter especially for those interested in the development of the Vostok spacecraft. This slim volume also contains the completely unexpurgated version of Korolev and Tikhonravov's landmark 1954 letter to the Soviet government.

Several works from these three books have been translated into English. Some of them, including the complete 1954 report, can be readily seen at the NASA History Office Web site at <http://www.hq.nasa.gov/office/pao/History/sputnik/ussr.html>.

Soviet-era military organizations have published their own histories. The two most useful texts of the Strategic Missile Forces are *Raketnyye voyska strategicheskogo naznacheniya* (*Missile Forces of Strategic Designation*) (Moscow: RVSN, 1992) and *Khronika osnounykh sobyitiy istorii raketnykh uoyk strategicheskogo naznacheniya* (*Chronicle of the Primary Events in the History of the Missile Forces of Strategic Designation*) (Moscow: TsIPK, 1994). The latter is a particularly important book because it includes the complete text of the famous May 1946 decree on the formation of the Soviet missile program. The book also contains unedited reproductions of many relevant documents from the famous R-16 disaster in 1960, which killed more than 100 people. The original decree on the formation of the Strategic Missile Forces is also included. There is also Ye. B. Volkov's *Mezhkontinentalnyye ballisticheskiye rakety SSSR (RF) i SShA* (*Intercontinental Ballistic Missiles of the USSR (RF) and the USA*) (Moscow: RVSN, 1996), which is an official history of the missile programs of the Strategic Missile Forces, handy for a technical overview. Finally, a recent history of the defunct Military Space Forces that contains much previously classified information is worth seeking out for understanding Soviet military space policy during the Cold War. See V. V. Favorskiy and I. V. Meshcheryakov, eds., *Voyenno-kosmicheskiye sily (uoyenno-istoricheskiy trud): kniga I: kosmonautika i uooruzhennyye sily* (*Military-Space Forces [Military-Historical Work]: Volume I. Cosmonautics and the Armed Forces*) (Moscow: Sankt-Peterburgskoy tipografii no. 1 VO Nauka, 1997).

There is also a remarkable work available on the evolution of the Soviet military-industrial complex, based exclusively on primary archival documentation. I would highly recommend the following book for any scholar attempting to gain insight into the interactions among the Soviet military, industry, and state during the Cold War. See N. S. Simonov, *Voyenno-promyshlenny kompleks SSSR v 1920-1950-ye gody: tempy ekonomicheskogo rosta, struktura, organizatsiya proizvodstva i uprauleniye* (*Military-Industrial Complex of the USSR from 1920-1950s: Rate of Economic Growth, Structure, Organization of Production and Administration*) (Moscow: ROSSPEN, 1996).

I would add some more sources into this first category. One Soviet-era journal has published a remarkable set of original and unedited documents from Gagarin's flight in 1961. These included the complete downlink during the launch phase of the mission and Gagarin's own report to the State Commission following landing. They can be found in V. Belyanov, L. Moshkov, Yu.

CHALLENGE TO APOLLO

Murin, N. Sobolev, A. Stepanov, and B. Stroganov, "Yuriy Gagarin's Star Voyage: Documents from the First Flight of a Human into Space" (English title), *Izvestiya TsK KPSS* 5 (1991): 101-29. In addition, the journal *Voyenno-istoricheskiy zhurnal* (Military-History journal) has published complete texts of many of the documents related to Korolev's arrest and incarceration in the late 1930s. These can be found in its October and November 1989 issues.

All of Georgiy Vetrov's works should also be included in this first category. His book *S. P. Korolev i kosmonavtika: pervye shagi* (*S. P. Korolev and Cosmonautics: First Steps*) (Moscow: Nauka, 1994) is quite possibly the best scholarly work on Korolev's pre-1945 work on rocketry. Vetrov's April and May 1994 articles in *Nauka i zhizn* (Science and Life) on the NI rocket include reproductions of several original design bureau and governmental documents from the 1960s on the development of this booster. Before his death, Vetrov prepared a number of manuscripts that contain original documentation or interpretations of primary sources. These include *S. P. Korolev: Nauchnaya biografiya* (*S. P. Korolev: A Scientific Biography*), co-authored with his wife K. A. Krasnova. He also prepared a book called *Otkrytiye kosmosa* (Opening Space), which is a history of the early space program. Excerpts from this book have been published in issues 16 and 23 of the journal *Novosti kosmonavtiki* (News of *Cosmonautics*) in 1997 as well as the October 1997 issue of *Nauka i zhizn*. Another book, not completely finished, was *Taynyye tropy kosmonavtiki* (Hidden Ways of Cosmonautics), which is a nontechnical account of the relationships among Korolev, Glushko, and Ustinov. A final book apparently also completed is *Sekrety ostrova Gorodomlya* (Secrets of *Gorodomlya* Island), about the German rocket scientists in the Soviet Union following World War II. Most of these books were to have been published in 1997-98, but financial problems at the Nauka publishers have delayed their issuing. Vetrov's death seems to have delayed plans for publishing even further.

Official Organization Histories

In the second category, at least three Soviet-era space organizations have published detailed institutional and technical histories. I would highly recommend *Raketno-Kosmicheskaya Korporatsiya "Energiya" imeni S. P. Koroleva* (The "*Energiya*" Rocket-Space Corporation Named After *S. P. Korolev*) (Korolev: RKK Energiya, named after *S. P. Korolev*, 1996), which is a massive work covering the entire history of the Korolev design bureau. The book reproduces many of original documents from the space program; the entire narrative is based completely on the internal archives of the organization. Less useful is *Gosudarstvennyy kosmicheskii nauchno-proizvodstvennyy tsentr imeni M. V. Khrunicheva* (State Space Scientific-Production Center Named After *M. V. Khrunichev*) (Moscow: RUSLIT, 1997), a somewhat Soviet-era style history of the Khrunichev Machine Building Plant. Chief Designer Yangel's Yuzhnoye Plant has also published a detailed chronology of its participation in the missile and space programs. This is *V. Pappo-Korystin, V. Platonov, and V. Pashchenko's Dneprovskiy raketno-kosmicheskii tsentr* (Dneprov Rocket-Space Center) (Dnepropetrovsk: PO YuMZ/KBYu, 1994). This work has an incredibly detailed chronology of the life of the organization and is packed with previous classified information relevant to the evolution of the Soviet space program.

Participant Biographies

Without a doubt, the most essential biography of any player in the Soviet space program is Yaroslav Golovanov's *Korolev: fakty i mify* (Korolev: Facts and Myths) (Moscow: Nauka, 1994). This 800-page work, sixteen years in the making, is not only an indispensable historical

work, but also a magnificent piece of literature, unrivaled in its scope and lyrical quality. Another recommended biography of Korolev is Aleksandr Romanov's *Koroleu* (Moscow: Molodaya gvardiya. 1996), which has been updated several times since its original publication in 1976. Romanov's work has a different tenor to Golovanov's biography in that it is slightly more anecdotal and lacks critical analysis.

Unfortunately, there have not been any in-depth treatments of other Soviet chief designers or officials in the post-1988 era. Researchers can search out N. C. Babakin, A. N. Banketov, and V. N. Smorkalov's *G. N. Babakin: zhizn i deyatelnost* (*G. N. Babakin: Life and Activities*) (Moscow: Adamant. 1996), which is a fairly good post-Soviet account of Babakin's life. There is also V. K. Kupriyanov and V. V. Chernyshev's *■ uechernyy start. . . : rasskaz o glavnom konstruktorye raketnykh duigateley Alekseye Mikhaylouichye Isayevye* (*Evening Launch Accounts on the Chief Designer of Rocket Engines Aleksey Mikhaylovich Isayev*) (Moscow: Moskovskiy rabochiy. 1988), which suffers a little from Soviet-era censorship. One book, A. P. Romanov and V. S. Gubarev's *Konstruktory (Designers)* (Moscow: Izdatelstvo politicheskoy literatury. 1989), contains substantial biographies of Clushko and Yangel in addition to Korolev.

Although strictly not a biography, another book, A. Yu. Ishlinskiy's *Akademik S. P. Koroleu. ucheniy, inzhener, chelouek* (*Academician S. P. Koroleu: Scholar, Engineer, Person*) (Moscow: Nauka. 1986), is a very useful gathering of recollections by dozens of men and women who knew Korolev. I highly recommend it to anyone interested in Korolev's life. A complete English translation of this is available at the NASA History Division prepared by the Translation Division of the Foreign Technology Division at Wright-Patterson Air Force Base in Ohio. The translation reference number is FTD-ID(RS)T-1140-87; it was issued on April 29, 1988. Comparable in spirit, but vastly more informative is a work on Clushko, *Odnazhdy i nausegda . . . : dokumenty i lyudi o sozdatelye raketnykh duigateley i kosmicheskikh sistem akademikye Valentinye Petrouichye Clushko* (*Once and Forever . . . : Documents and People on the Creation of Rocket Engines and Space Systems of Academician Valentin Petrovich Clushko*) (Moscow: Mashinostroyeniye. 1998), edited by V. F. Rakhmanin and L. Ye. Sterpin. This particular book on Clushko illuminates many episodes from the Soviet space program from a completely different perspective—that is, the story from "the other side," as it were. Less helpful is Drnritriy Khrapovitskiy's *Generalnyy Konstruktor Akademik V N. Chelomey* (*General Designer Academician V N. Chelomey*) (Moscow: Vozdushniy transport, 1990). There is also B. V. Raushenbakh's *Iz istorii Souetskoy kosmonautiki: sbornik pamyati Akademika S. P. Koroleva* (*From the History of Soviet Cosmonautics: A Collection of Memories of Academician S. P. Koroleu*) (Moscow: Nauka. 1983), which has an extremely detailed chronology of Korolev's entire life, including dates for many of his missile and spacecraft studies.

Oral Histories and Memoirs

The fourth category is memoirs. The most thorough and impartial memoirs authored by any participant in the Soviet space program have been those by Korolev's deputy Boris Chertok. By 1998, he had published three thick volumes: *Rakety i lyudi* (*Rockets and Men*) (Moscow: Mashinostroyeniye, 1994), which addresses roughly the period 1945 to 1957; *Rakety i lyudi: Fili Podlipki Tyuratam* (*Rockets and Men: Fili Podlipki Tyura-Tam*) (Moscow: Mashinostroyeniye. 1996), which contains events from 1957 to 1961; and *Rakety i lyudi: goryachiye dni kholodnoy voyny* (*Rockets and Men: Hot Days of the Cold War*) (Moscow: Mashinostroyeniye, 1997), which covers 1961 to 1968. These three volumes collectively should be the starting point for any scholar interested in the history of the Soviet space program. Chertok is an amazingly astute observer with a stunning memory for detail. These are invaluable rich contributions to this history. A fourth volume on the lunar program is evidently on the way.

CHALLENGE TO APOLLO

Equally essential are the diaries of General Nikolay Kamanin. Since 1989, his son Lev Kamanin has published excerpts from his diaries piece by piece in various newspapers. His journals from 1960 to 1966 have been collected into two very handy volumes, *Skrytiy kosmos: kniga pervaya. 1960–1963gg* (Hidden Space: Volume One. 1960–1963) (Moscow: Infotekst IF, 1995) and *Skrytiy kosmos: kniga vtoraya, 1964–1966gg* (Hidden Space: Volume Two. 1964–1966) (Moscow: Infotekst IF, 1997). Further additions to the series are expected in the near future. In the meantime, those interested in diary entries for 1966 to 1974 can search out issues of the Russian newspaper *Vozdushniy transport* (Air Transport), which has published extensive entries in issues 12 to 15, 23 to 25, and 43 to 50 in 1993 and in issues 9 to 19 in 1994. Almost all of these newspaper issues have been translated into English and are available at the NASA History Division as NASA TT-2 1658 dated December 1994. Researchers should note that the translations have been compiled in some cases without regard to chronological order.

Other memoirs relevant to Soviet space history include Sergey Khrushchev's two-volume *Nikita Khrushchev: krizisy i rakety: vzglyad iznutri* (Nikita Khrushchev: Crises and Missiles: View From the Inside) (Moscow: Novosti, 1994). A slightly different English version of these two volumes is to be published in 2000 under the title *The Creation of a Superpower (A View From the Inside)*. One designer of the Soviet lunar lander has published a book on its development, *Vospominaniya o lunnom korablye* (Recollections on the Lunar Ship) (Moscow: Kultura, 1992).

An invaluable addition to the literature on Soviet space history are the *Dorogi v kosmos* (Roads to Space) series prepared by the Scientific-Research Center for Space Documentation in Moscow. These volumes include reminiscences from some of the most important players in the 1950s and 1960s—most notably some politicians, who have been notoriously absent in writing their memoirs. The contributors to this series include Minister Afanasyev, Military-Industrial Commission Deputy Pashkov, Chief Designers Barmin and Mishin, NI designer Kryukov, Vostok designer Ivanovskiy, artillery officers Mozzhorin, Nesterenko, and Tyulin, and physician Yazdovskiy. Three volumes have been published so far: *Dorogi v kosmos: I* (Roads to Space: I) (Moscow: MAI, 1992), *Dorogi v kosmos: II* (Roads to Space: II) (Moscow: MAI, 1992), and *Nachalo kosmicheskoy ery: vospominaniya veteranou raketno-kosmicheskoy tekhniki i kosmonavtiki: uypusk vtoroy* (The Beginning of the Space Era: Memoirs of Veterans of Rocket-Space Technology and *Cosmonautics*: Volume Two) (Moscow: RNITsKD, 1994). A large selection from these three volumes has been translated into English and published as one book under the title *Roads to Space* (New York: McGraw-Hill, 1995). Unfortunately, I would not recommend the translation; it is filled with egregious errors and distorts many of the original passages and quotes from the Russian edition. The NASA History Division has translated two chapters from the first volume of the Russian edition. These can be found in NASA TT-2 1770 dated 1995.

For those interested in the development of the Soviet ground communications network, I would recommend *Kosmos nachinayetsya na zemlye* (Space Begins From the Earth) (Moscow: Patriot, 1996), which is written by B. A. Pokrovskiy, one of the major players in the network's creation. There have been many memoirs published on the creation of the Baykonur Cosmodrome. Perhaps the best one is the Council of Veterans of the Baykonur Cosmodrome's *Nezabyuayemyy Baykonur* (Unforgettable Baykonur) (Moscow: Interregional Council of Veterans of the Baykonur Cosmodrome, 1998), which among other things contains a blow-by-blow detailed chronology of the launch range from 1957 to 1961. I would also recommend the same council's *Proryu v kosmos: ocherki ob ispitatelyakh spetsialistakh i stroitelyakh kosmodroma Baykonur* (Breakthrough Into Space: Essays on Test Specialists and Builders of the Baykonur Cosmodrome) (Moscow: TOO Veles, 1994).

Some participants have published isolated articles in the Soviet and Russian media. Former NII-88 Director Yuriy Mozzhorin has co-authored an excellent two-part series of articles with

A. Yeremenko on the origins of the Soviet missile and space program. These can be found in the July and August 1991 issues of *Auiatsiya i kosmonautika* (Aviation and Cosmonautics). Translations of these can be found in JPRS-UAC-92-002 dated February 3, 1992, and JPRS-UAC-92-003 dated February 13, 1992. An amplification of these articles by Biryukov and Yeremenko was published in *Nouosti kosmonautiki* in issue 10 from 1996. Artillery officer Aleksandr Maksimov has authored an illuminating series of articles on the first launches from Baykonur. These can be found in the September–October 1990, November–December 1990, January–February 1991, and March–April 1991 issues of *Zemlya i uselennaya* (Earth and Universe). Before his death, artillery officer Georgiy Tyulin authored a wonderful series of memoirs from his experiences covering the early years of the space program. These were published in the newspaper *Krasnaya zvezda* (Red Star) on April 2, 3, and 5, 1988, May 18, 1988, and April 1, 1989. The April 1988 issues have been translated in JPRS-USP-89-001 issued on January 18, 1989. The April 1989 article can be found in JPRS-UMA-89-013 issued on May 26, 1989.

NI designers Dolgopyatov, Dorofeyev, and Kryukov published an article on the giant rocket in the September 1992 issue of *Auiatsiya i kosmonautika*. NI designer Kryukov has also written on the rocket in the April 1994 issue of *Nauka i zhizn*. Chief Designer Mishin wrote a long article on the same project in the December 1990 issue of *Znaniye: tekhnika: seriya kosmonautika, astronomiya* (Knowledge: Technology: Cosmonautics. Astronomy Series). This is a very important piece because it is Mishin's only in-depth commentary on the Soviet piloted lunar program, the central thematic goal of his design bureau during the late 1960s. There is a complete translation of this in JPRS-USP-91-006 dated November 12, 1991. Vladimir Polyachenko, a senior designer of Chelomey's Almaz program, has published a two-part article on Almaz in the January and April 1992 issues of *Krylia rodney* (Wings of the Motherland). These are available in English translation at the NASA History Division as NASA TT-21769 dated 1995.

Historian Articles and Books

The fifth category includes articles by Russian and Soviet journalists on the history of the Soviet space and missile programs. Many of these researchers have access to both primary documents and major participants in the effort. Certainly one of the most useful works by a Soviet researcher is Igor Afanasyev's "Unknown Spacecraft (From the History of the Soviet Space Program)," which was published in the December 1991 issue of *Znaniye: tekhnika; seriya kosmonautika, astronomiya*. This was the very first declassification of a plethora of Soviet piloted space projects that never reached fruition or were considered secret for more than thirty years. This work has been translated into English in JPRS-USP-92-003 dated May 27, 1992. Afanasyev has also authored an excellent series of articles on the history of the NI rocket in the journal *Krylia rodney* in the September, October, and November 1993 issues. Translations are available in JPRS-USP-94-002-L dated July 7, 1994. Viktor Kazmin's ground-breaking articles on the Spiral program were published in the same journal in November and December 1990 and in January 1991. A translation of this is in JPRS-USP-91-007 dated November 22, 1991. A useful article on Chelomey was in issues 4–5 of *Ogonek (Light)* in January 1994. An English translation of this is available at the NASA History Division as NASA TT-21771 dated 1995.

Several journals and newspapers were indispensable for research on this book. First and foremost was *Nouosti kosmonautiki*, which is a monthly (formerly biweekly) publication produced from Moscow. Many unprecedented revelations about previously hidden aspects of Soviet space history have come forth through this magazine, probably the best publication in the world devoted to space exploration. For the most part, authors tend to focus on technical rather than political or institutional aspects. The editors can be reached at i-cosmos@mtu-net.ru. An irregularly published journal that is very useful for historians is *Iz istorii auiatsii*

i kosmonavtiki (From the History of Aviation and Cosmonautics). I particularly recommend its issue number 42 from 1980, which contains a series of informative articles on the works of the pioneer Mikhail Tikhonravov.

The Russian military newspaper *Krasnaya zvezda* often has had revealing articles on space history by its history correspondent, the late Mikhail Rebrov. Rebrov authored a wonderful six-part series on the original members of the Council of Chief Designers, which was published on October 22, 1988 (Barmin). January 7, 1989 (Kuznetsov). February 25, 1989 (Pilyugin). March 11, 1989 (Ryazanskiy). July 1, 1989 (Korolev), and August 26, 1989 (Glushko). A seventh article on April 8, 1989, was on the council itself. In the following years, Rebrov wrote dozens of more articles on various aspects of Soviet space history in the same newspaper. Many of these have been collected into one work. *Kosmicheskiye katastrofy: stranichki iz sekretnogo dosye (Space Catastrophes: Pages From the Secret Dossier)* (Moscow: Eksprint NV, 1996).

English-language Sources

For those without knowledge of the Russian language, studying Soviet space history presents significant obstacles. Most of the English-language works are dated because they were published during the Soviet era. Fortunately, many of them are still worth perusing as excellent starting points for an introduction to the Soviet space program. I would highly recommend Nicholas Daniloff's *The Kremlin and the Cosmos* (New York: Alfred A. Knopf, 1972), which is a well-researched book that still stands up incredibly well, almost thirty years after its publication. F. J. Krieger's *Behind The Sputniks: A Survey of Soviet Space Science* (Washington, DC: Public Affairs Press, 1958) is an excellent collection of translations of pre-1958 articles on space exploration from the Soviet media. Certainly, the most famous book on the Soviet space program is James E. Oberg's *Red Star in Orbit* (New York: Random House, 1981), a still-readable account of what we knew about the Soviet space effort in the early 1980s. For those interested in more technical matters, Phillip Clark's *The Soviet Manned Space Program: An Illustrated History of the Men, the Missions, and the Spacecraft* (New York: Orion, 1988) is an incomparable treatise on all Soviet piloted space missions. Equally useful is Dennis Newkirk's *Almanac of Soviet Manned Space Flight* (Houston: Gulf Publishing Co., 1990), which is essentially a strict chronology culled from hundreds of sources. A good starting point for those interested in Soviet lunar and planetary exploration is Andrew Wilson's *Solar System log* (London: Jane's Publishing Co., 1987).

One of the few post-1989 works on Soviet space history is James Harford's *Korolev: How One Man Masterminded the Soviet Drive to Beat America to the Moon* (New York: John Wiley & Sons, 1997). Although strictly a biography, Harford masterfully weaves a larger history from dozens of priceless interviews with many participants of the Soviet program from the 1950s and 1960s. I would highly recommend T. A. Heppenheimer's *Countdown: A History of Space Flight* (New York: John Wiley & Sons, 1997), a superbly written history of the early space era with considerable attention to Soviet achievements. A book exclusively on the Soviet piloted lunar program is Nicholas L. Johnson's *The Soviet Reach for the Moon* (Cosmos Books, 1995). It is now out of print.

Two books peripherally related to the Soviet space program that were very useful for my own work were David Holloway's *Stalin and the Bomb: The Soviet Union and Atomic Energy: 1939-1956* (New Haven: Yale University Press, 1994) and Steven J. Zaloga's *Target America: The Soviet Union and the Strategic Arms Race, 1945-1964* (Novato, CA: Presidio, 1993). Both benefit greatly from the fact that the authors were able to extensively use recently declassified information from Russian sources. Combined together, these two works are probably the best existing studies in English on the development of Soviet strategic weapons in the immediate postwar era.

The Congressional Research Service at the Library of Congress published a series of excellent summaries of the Soviet space program during the Cold War titled *Soviet Space Programs*. They covered the years 1962, 1962-65, 1966-70, 1971-75, 1976-80, and 1981-87. Packed with vast amounts of information, all of these books are now out of print but can be found at any major university library. I highly recommend these volumes to any serious scholar of the Soviet space program. Unlike many other works on Soviet space history, these books are particularly useful for analyses of space law, institutions, resource burdens, political motives, and international cooperation in the Soviet space program. Soviet-U.S. international cooperation in space is also the subject of Dodd L. Harvey and Linda C. Ciccoritti's excellent *U.S.-Soviet Cooperation in Space* (Miami: Center for Advanced International Studies, University of Miami, 1974).

The political motives of the early Soviet space program are the subject of two seminal works. These are Walter McDougall's . . . the Heavens and the Earth: A Political History of the Space Age (New York: Basic Books, 1985) and William H. Schauer's *The Politics of Space: A Comparison of the Soviet and American Space Programs* (New York: Holmes & Meier, 1976). Although both have dated somewhat in terms of their interpretations of the Soviet space program, I would particularly recommend McDougall's work as an excellent starting place to understand the Soviet government's views toward the role of technology in society. For a more recent scholarly view from a political science perspective, I would recommend William P. Barry's excellent *The Missile Design Bureaus and Soviet Piloted Space Policy, 1953-1974*, which is a doctoral dissertation at the University of Oxford from 1995.

The American Astronautical Society (AAS) publishes a series titled *History of Rocketry and Astronautics* as part of the AAS History Series. Many of these volumes contain very informative articles by direct participants of the Soviet space program. The AAS can be reached at AAS Publications, P.O. Box 28130, San Diego, CA 92198.

One important English-language source for Soviet space history are papers presented at the annual congresses of the International Astronautical Federation. These can be obtained at the International Astronautical Federation, 3-5 Rue Mario-Nikis, 75015, France. There are usually several papers every year that address important aspects of Soviet space history.

Uncovering the institutional machinations of the Soviet defense industry, and thus their space program, has been a difficult process, but some Soviet-era works have been useful as starting points. These included Michael McGwire, Ken Booth, and John McDonnell's *Soviet Naval Policy: Objectives and Constraints* (Halifax, NS: Centre for Foreign Policy Studies, 1975), David Holloway's *The Soviet Union and the Arms Race* (New Haven, CT: Yale University Press, 1984), Jiri Valenta and William C. Potter's *Soviet Decisionmaking for National Security* (London: George Allen & Unwin, 1984), David Lane's *Elites and Political Power in the USSR* (Edward Elgar, 1988), Timothy J. Colton and Thane Gustafson's *Soldiers and the Soviet State: Civil-Military Relations From Brezhnev to Gorbachev* (Princeton, NJ: Princeton University Press, 1990), and Peter Almquist's *Red Forge: Soviet Military Industry Since 1965* (New York: Columbia University Press, 1990). Arthur J. Alexander's still-remarkable work "Decision-Making in Soviet Weapons Procurement" in the Winter 1978/1979 issue of *Adelphi Papers* is a gold mine of information on the operations of the Soviet defense industry. A useful summary of information on the organization of the Soviet space program is contained in the August and September 1994 issues of the magazine *Spaceflight*. There is also an excellent Web site maintained by the Federation of American Scientists that contains detailed historical information on dozens of Soviet-era design bureaus and institutes specializing in space and missile technology. See <http://www.fas.org/spp/civil/russia/index.html>.

Despite its age, particularly useful in excavating the shifts in the Kremlin power structure during the Khrushchev era was Michael Tatu's *Power in the Kremlin: From Khrushchev's Decline to Collective Leadership* (London: Collins, 1969). An indispensable reference of information on the Soviet government and Communist Party was Edward L. Crowley, Andrew I. Lebed, and

BIBLIOGRAPHIC ESSAY

Dr. Heinrich E. Schulz's *Party and Government Officials of the Soviet Union 1917-1967* (Metuchen, NJ: The Scarecrow Press, 1968), which contains lists of all senior Party and government officials in the Soviet era up to 1968. A post-Soviet English-language book highly recommended for those interested in the Cold War in general is Vladislav Lubok and Constantine Pleshakov's *Inside the Kremlin's Cold War: From Stalin to Khrushchev* (Cambridge, MA: Harvard University Press, 1996), which is based on recently declassified archival material.

A vast amount of technical information on the history of the Soviet space program has been published in English since 1989. *Quest: The Journal of Spaceflight History* should be a starting point for anyone with a cursory interest in the topic. Although not strictly focused on history, *Spaceflight*, a magazine of the British Interplanetary Society, has published many interesting articles on the history of the Soviet space program. For those interested in technical aspects, I would recommend articles by Timothy Varfolomeyev in the August 1995, February 1996, June 1996, January 1998, March 1998, and May 1998 issues on the development of Soviet launch vehicles. The journal *of the British Interplanetary Society* also publishes an annual Soviet astronautics issue. For example, readers can search out an article by Mikhail Tikhonravov in the May 1994 issue of the magazine on the creation of Sputnik. An ongoing series in the same journal on military space topics, edited by Dwayne Day, has also included several important articles on Soviet space history.

I would highly recommend two books written in neither English nor Russian. The first is Christian Lardier's *L'Astronautique Sovietique* (Paris: Armand Colin, 1992). For those interested in the technical arcana of the Soviet space program, this is the best book ever written on the subject. It uses much information declassified by the Soviets following 1988 and is incomparable in its breadth and ambition to any other book published on the subject in either English or Russian. Although published during the Soviet era, I would also highly recommend Peter Stache's *Sowjetischer Raketen* (Berlin: Militärverlag der DDR, 1987), which is in Polish. Fortunately, a complete English translation is available at the NASA History Division as prepared by the Translation Division of the Foreign Technology Division at Wright-Patterson Air Force Base. The translation reference number is FTD-ID(RS)T-0619-88; it is dated November 29, 1988.

Declassified Documents

A vast number of the CIA's National Intelligence Estimates (NIE) on the Soviet space and missile programs have now been declassified. For the space program in particular, these include NIEs issued on:

- December 5, 1962 (NIE 11-1-62)
- January 27, 1965 (NIE 11-1-65)
- March 2, 1967 (NIE 11-1-67)
- April 4, 1968 (NIE 11-1-68)
- June 19, 1969 (NIE 11-1-69)
- March 26, 1970 (NIE 11-1-70)
- July 1, 1971 (NIE 11-1-71)
- December 20, 1973 (NIE 11-1-73)
- July 19, 1983 (NIE 11-1-83)
- July 19, 1983 (NIE 11-1-83JX)
- December 1985 (NIE 11-1-85J)

All of these were titled *The Soviet Space Program* or (from 1973) *Soviet Space Programs*.

For the Soviet missile program in particular, most of the NIEs have also been declassified. Until 1962, assessments of the Soviet space program were included with the missile reports. I would recommend the following:

- October 5, 1954 (NIE 11-6-54)
- August 19, 1958 (NIE 11-5-58)
- November 3, 1959 (NIE 11-5-59)
- May 3, 1960 (NIE 11-5-60)
- April 25, 1961 (NIE 11-5-61)

These were titled *Soviet Capabilities and Probable Programs in the Guided Missile Field* (in 1954) and then *Soviet Capabilities in Guided Missiles and Space Vehicles*. All of these NIEs are invaluable for confirming or debunking unsubstantiated claims from the Russian media on various aspects of the Soviet space program. At the same time, I would caution researchers to use them with care, because it is clear that in certain areas, such as the institutional backdrop of the Soviet program, the CIA knew very little until well into the late 1960s.

One particularly useful CIA document is the agency's Office of Scientific Intelligence's *Scientific Research Institute and Experimental Factory 88 for Guided Missile Development, Moskva/Kaliningrad*. This report is numbered OSI-C-RA/60-2 and was issued on March 4, 1960. It addresses U.S. knowledge of the famous NII-88 institute in the late 1950s. Another useful report is the CIA Directorate of Science and Technology's *Scientific and Technical Intelligence Report: The Major Soviet Missile Design Bureaus*. This report was issued in June 1973. The study is notable because it illustrates not only what the CIA knew but also what it guessed completely wrong. For the defense industry in general, I would recommend the CIA Directorate of Intelligence's *The Soviet Weapons Industry: An Overview*, numbered DI 86-10016 and dated September 1986. A useful report on Soviet science is the NIE 11-6-59 titled "Soviet Science and Technology," issued on July 21, 1959. Several articles in the CIA journal *Studies in Intelligence* on the Soviet space program have also been declassified as part of the CIA's Historical Review Program. A number of the declassified CIA documents are readily available to any researcher at the National Archives at 8601 Adelphi Road, College Park, MD 20740-6001. The phone number is (301) 713-6645. The National Archives can also be reached by e-mail at cer@nara.gov.

Interviews and Correspondence

The final category is interviews and correspondence. These are listed in chapter references.

TABLES

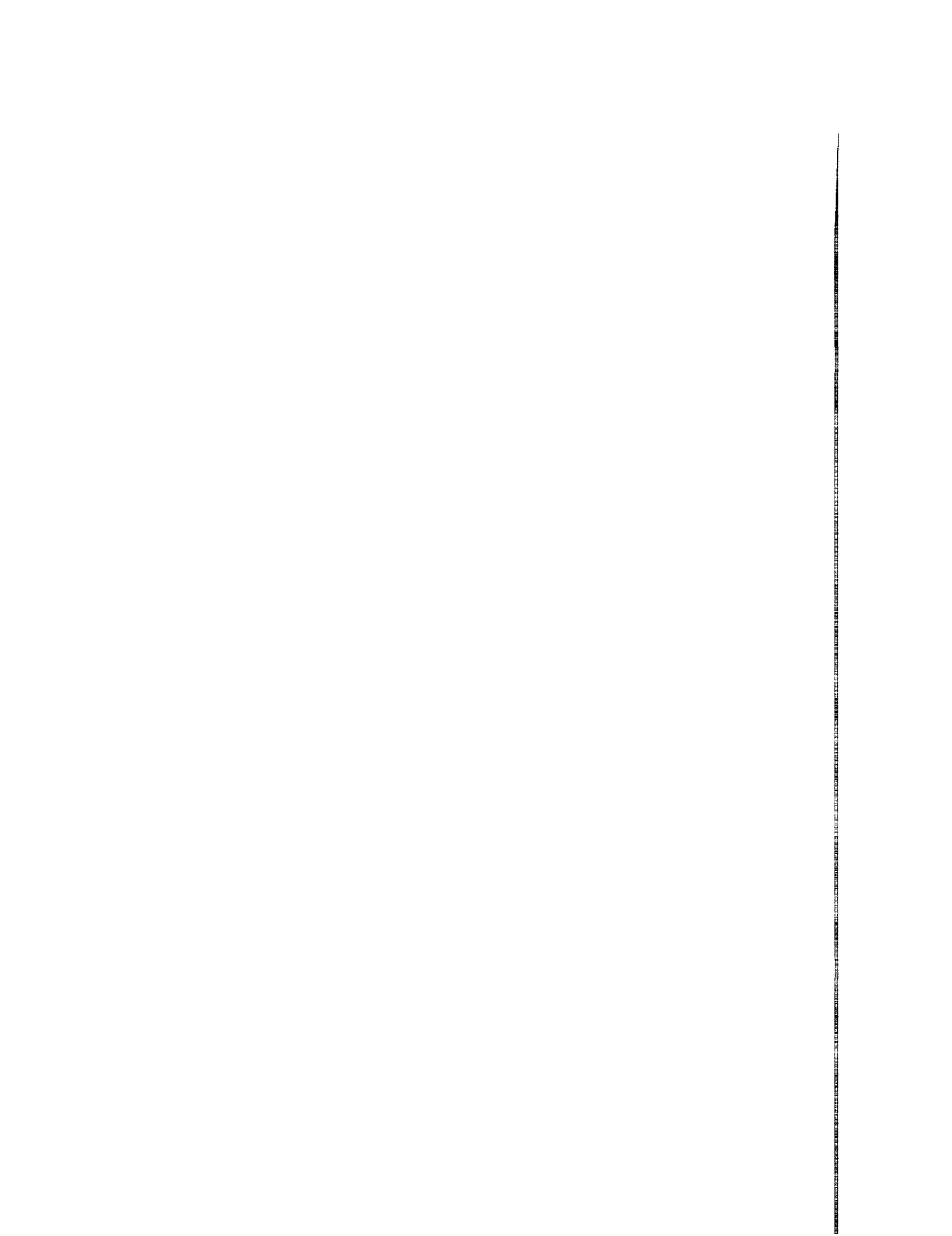

Table IA
Orbital Launch Attempts in the Soviet Piloted Space Program, 1960-74

Mission Name	Launch Date	Launch Time (Moscow Time)	Production Index of Spacecraft	Spacecraft Type	Spacecraft Serial No.	Launcher	Launcher Serial No.	Launch Site at Tyura-Tam
Vostok Program								
Korabl-Sputnik	May 15, 1960	0300:05.6	11F61	1KP		8K72	L1-11	1
	July 28, 1960	1231	11F61	1K	1	8K72	L1-10	1
Korabl-Sputnik 2	Aug. 19, 1960	1144:06.8	11F61	1K	2	8K72	L1-12	1
Korabl-Sputnik 3	Dec. 1, 1960	1030:04.3	11F61	1K	5	8K72	L1-13	1
	Dec. 22, 1960	1045:19	11F61	1K	6	8K72K	L1-13A	1
Korabl-Sputn-14	Mar. 9, 1961	0928:59.6	11F63	3KA	1	8K72K	E103-14	1
Korabl-Sputn-16	Mar. 25, 1961	0854:00.4	11F63	3KA	2	8K72K	E103-15	1
Vostok	Apr. 12, 1961	0906:59.7	11F63	3KA	3	8K72K	E103-16	1
Vostok 2	Aug. 6, 1961	0900	11F63	3KA	4	8K72K	E103-17	1
Vostok 3	Aug. 11, 1962	1130	11F63	3KA	5	8K72K	-	1
Vostok 4	Aug. 12, 1962	1102:33	11F63	3KA	6	8K72K	-	1
Vostok 5	Jun. 14, 1963	1158:58	11F63	3KA	7	8K72K	-	1
Vostok 6	Jun. 16, 1963	1229:52	11F63	3KA	8	8K72K	-	1
Voskhod Program								
Kosmos-47	Oct. 6, 1964	1000	11F63	3KV	2	11A57	-	1
Voskhod	Oct. 12, 1964	1030:01	11F63	3KV	3	11A57	-	1
Kosmos-57	Feb. 22, 1965	1030	11F63	3KD	1	11A57	-	1
Kosmos-59	Mar. 7, 1965	-	11F69	4K	-	11A57	-	-
Voskhod 2	Mar. 18, 1965	1000:00	11F63	3KD	4	11A57	-	1
Kosmos-110	Feb. 22, 1966	2309.36	11F63	3KV	5	11A57	-	1
Soyuz Program								
Kosmos-133	Nov. 28, 1966	1400	11F615	7K-OK(A)	2	11A511	U150002	31
-	Dec. 14, 1966	1400	11F615	7K-OK(P)	1	11A511	U150001	31
Kosmos-140	Feb. 7, 1967	0620	11F615	7K-OK(P)	3	11A511	-	1
Soyuz 1	Apr. 23, 1967	0035:00	11F615	7K-OK(A)	4	11A511	-	1
Kosmos-186	Oct. 27, 1967	1230	11F615	7K-OK(A)	6	11A511	-	31
Kosmos-188	Oct. 30, 1967	1112	11F615	7K-OK(P)	5	11A511	-	1

TABLE I

CHALLENGE TO APOLLO

Mission Name	Lunch Date	Launch Time (Moscow Time)	Production Index of Spacecraft	Spacecraft Type	Spacecraft Serial No.	Launcher	Launcher Serial No.	Lunch Site at Tyura-Tam
Kosmos-212	Apr 14, 1968	1300	11F615	7K-OK(A)	8	11A511	-	
Kosmos-213	Apr 15, 1968	1234	11F615	7K-OK(P)	7	11A511	-	
Kosmos-238	Aug 28, 1968	1259	11F615	7K-OK(P)	9	11A511	-	
Soyuz 2	Oct 25, 1968	1200	11F615	7K-OK(P)	11	11A511	-	1
soyuz 3	Oct 26, 1968	1134	11F615	7K-OK(A)	10	11A511	-	31
Soyuz 4	Jan 14, 1969	1029	11F615	7K-OK(A)	12	11A511	-	31
Soyuz 5	Jan 15, 1969	1005	11F615	7K-OK(P)	13	11A511	-	1
Soyuz 6	Oct 11, 1969	1410:00	11F615	7K-OK(D)	14	11A511	-	31
soyuz 7	Oct 12, 1969	1344:47	11F615	7K-OK(P)	15	11A511	-	1
Soyuz 8	Oct 13, 1969	1319:09	11F615	7K-OK(A)	16	11A511	-	31
soyuz 9	June 1, 1970	2300:00	11F615	7K-OK(D)	17	11A511	-	
soyuz 10	Apr 23, 1971	0254	11F615A8	7K-T	31	11A511	25	-
Soyuz 11	June 6, 1971	0755	11F615A8	7K-T	32	11A511	-	-
Kosmos-496	June 26, 1972	1753	11F615A8	7K-T	33L	11A511	-	-
Kosmos-573	June 15, 1973	0900	11F615A8	7K-T	35	11A511	-	-
soyuz 12	Sept 27, 1973	1518	11F615A8	7K-T	36	11A511	-	-
Kosmos-613	Nov 30, 1973	0820	11F615A8	7K-T	34L	11A511	-	-
Soyuz 13	Dec 18, 1973	1455	11F615A8	7K-T	33A	11A511	-	-
Kosmos-638	Apr 3, 1974	1031	11F615A12	7K-TM	71	11A511U	-	-
Kosmos-656	May 27, 1974	1026	11F615A9	7K-TA	61	11A511	-	-
Soyuz 14	July 3, 1974	2151	11F615A9	7K-TA	62	11A511	-	-
Kosmos-670	Aug 6, 1974	0301	11F732	7K-S	1L	11A511U	-	-
Kosmos-672	Aug 12, 1974	0924	11F615A12	7K-TM	72	11A511U	-	-
Soyuz 15	Aug 26, 1974	2257:54	11F615A9	7K-TA	63	11A511	-	-
Soyuz 16	Dec 2, 1974	1240:00	11F615A12	7K-TM	73	11A511U	-	-
Zond Program								
Kosmos-146	Mar 10, 1967	1430:33	11F91	7K-LIP	2P	8K82K/11S824	227-01	81L
Kosmos154	Apr 8, 1967	1200:33	11F91	7K-LIP	3P	8K82K/11S824	228-01	81L
-	Sept 28, 1967	0111:54	11F91	7K-LI	4L	8K82K/11S824	229-01/12L	81L
-	Nov 22, 1967	2207:59	11F91	7K-LI	5L	8K82K/11S824	230-01/13L	81P
Zond 4	Mar 2, 1968	2129:23	11F91	7K-LI	6L	8K82K/11S824	231-01	81L
-	Apr 23, 1968	0201:27	11F91	7K-LI	7L	8K82K/11S824	232-01/15L	81P

Mission Name	launch Date	launch Time (Moscow Time)	Production Index of Spacecraft	Spacecraft Type	Spacecraft Serial No.	Launcher	Launcher Serial No.	launch Site at Tyura-Tam
-	July 14, 1968	-	11F91	7K-LI	8	8K82K/11S824	233-01	81
Zond 5	Sept. 15, 1968	0042:11	11F91	7K-LI	9L	8K82K/11S824	234-01/17	81L
Zond 6	Nov. 10, 1968	2211:31	11F91	7K-LI	12L	8K82K/11S824	235-01/19	81L
-	Jan. 20, 1969	0714:36	11F91	7K-LI	13L	8K82K/11S824	237-01	81L
Zond 7	Aug. 8, 1969	0248:06	11F91	7K-LI	11	8K82K/11S824	243-01	81L
Zond 8	Oct. 20, 1970	2255:39	11F91	7K-LI	14	8K82K/11S824	250-01	81L
NI-L3 Program								
-	Feb. 21, 1969	1218:07	11F92	7K-LIS	3S	11A52	15003	110P
	July 3, 1969	2318:32	11F92	7K-LIS	5L	11A52	15005	110P
	June 28, 1971	0215:08	11F94/11F93 mock-ups	-	-	11A52	15006	110L
	Nov. 23, 1972	0911:55	11F93	7K-LOK	6A	11A52	15007	110L
7K-LIE Program								
-	Nov. 28, 1969	1200:00		7K-LIE	1	8K82K/11S824	245-01/25L	81L
Kosmos-382	Dec. 2, 1970	2000:00		7K-LIE	2K	8K82K/11S824	252-01/26	81L
T2K Program								
Kosmos-379	Nov. 24, 1970	1400	11F94	T2K	1	11A511L		
Kosmos-398	Feb. 26, 1971	1514	11F94	T2K	2	11A511L		
Kosmos-434	Aug. 12, 1971	1250	11F94	T2K	3	11A511L		
DOS/Salyut Program								
Salyut	Apr. 19, 1971	0440:00	11F715	17K	121	8K82K	254-01	81P
-	July 29, 1972	0620:57	11F715	17K	122	8K82K	260-01	81L
Kosmos-557	May 11, 1973	0320:00	11F715	17K	123	8K82K	284-01	81L
Salyut 4	Dec. 26, 1974	0715	11F715	17K	124	8K82K	284-02	81P
Almaz/Salyut Program								
Salyut 2	Apr. 3, 1973	1200:00	11F71	-	101-1	8K82K	283-01	81L
Salyut 3	June 25, 1974	0138:00	11F71	-	101-2	8K82K	283-02	81L

Table 1B
Mission Parameters for Selected Orbital Flights

Name	Mass(kg)	Orbits	Initial Orbital Parameters (km)*	Orbital Inclination (°)	Duration (days:hrs:min:sec)**	Crew
Vostok						
Korabl Sputnik	4540	-	312 X 369	65	843:09:36	
Korabl Sputnik 2	4600	27	306 X 339	64.95	01:02:23:36	
Korabl Sputnik 3	4563	24	180 X 249	64.97	01:01:45:36	
Korabl Sputnik 4	4700	1.92	183.5 X 248.8	64.93	00:01:47	
Korabl Sputnik 5	4695	1.92	178 X 247	65.9	00:01:47	
Vostok	4725	1	181 X 327	64.95	00:01:48	Gagarin
Vostok 2	4731	17	183 X 244	64.93	01:01:18	Titov
Vostok 3	4722	64	180.7 X 234.6	64.98	03:22:22	Nikolayev
Vostok 4	4728	48	179.8 X 236.7	64.95	02:22:56:27	Popovich
Vostok 5	4720	81	174.7 X 222.1	64.96	04:23:07:02	Bykovskiy
Vostok 6	4713	48	180.9 X 231.1	64.95	02:22:50:08	Tereshkova
Voskhod						
Kosrnos-47	c. 5320	-	177 X 413	64.77	01:00:18	-
Voskhod	5320	16	177.5 X 408	-	01:00:17.03	Kornarov, Feoktistov, Yegorov
Kosrnos-57	c. 5680	-	175 X 512	64.77	03:00:02	-
Kosrnos-59	c. 4730	-	209 X 339	65	8 days	-
Voskhod 2	5682	18	137 X 498	65	01:02:02:17	Belyayev, Leonov
Kosrnos-110	c. 5700	-	187 X 904	51.9	21:18:00	-
Soyuz						
Kosrnos-133	6386	34	181 X 232	51.9	01:21:21	-
Kosrnos-140	c. 6450	33	170 X 241	51.7	01:23:32	-
Soyuz 1	6450	18	203.1 X 221.1	51.72	01:02:47:52	Komarov
Kosmos-186	c. 6530	-	209 X 235	51.7	03:22:49	-
Kosrnos-188	c. 6530	-	200 X 276	51.68	03:00:58	-
Kosmos-212	6569	-	210 X 239	51.7	04:22:50	-
Kosmos-213	6458	-	205 X 291	51.4	05:00:37	-
Kosmos-238	c. 6520	-	199 X 219	51.7	03:23:04	-
Soyuz 2	6550	-	185 X 224	51.7	02:22:51	-

Name	Mass (kg)	Orbits	Initial Orbital Parameters (km)*	Orbital Inclination (°)	Duration (days:hrs:min:sec)**	Crew
soyuz 3	6575	64	183.5 X 222.2	51.69	03:22:50:45	Beregovoy
soyuz 4	6625	48	173 X 225.3	51.72	02:23:20:47	Shatalov
Soyuz 5	6585	49	198.7 X 230.2	51.69	03:00:54:15	Volynov, Yeliseyev, Khrunov
Soyuz 6	6577	80	186.2 X 222.8	51.68	04:22:42:47	Shonin, Kubasov
Soyuz 7	6570	80	207.4 X 225.9	51.68	04:22:40:23	Filipchenko, Volkov, Corbatko
Soyuz 8	6646	80	204.5 X 223.7	51.68	04:22:50:49	Shatalov, Nikolayev
Soyuz 9	6590	286	208 X 220.6	51.7	17:16:59	Nikolayev, Sevastyanov
Soyuz 10	6575	32	209.6 X 248.4	51.6	01:23:45:54	Shatalov, Yeliseyev, Rukavishnikov
soyuz 11	6790	384	191.5 X 220.5	51.64	23:18:21:43	Dobrovolskiy, Volkov, Patsayev
Kosmos-496	c. 6570	-	195 X 342	51.6	05:23:01	
Kosmos-573	c. 6570	-	209 X 268	51.55	02:01:12	
Soyuz 12	6720	31	193 X 248.6	51.61	01:23:15:32	Lazarev, Makarov
Kosmos-613	c. 6570	-	195 X 295	51.6	60:00:09	-
Soyuz 13	6560	127	193.3 X 272.7	51.6	07:20:55:35	Klimuk, Lebedev
Kosmos-638	c. 6570	-	195 X 325	51.8	09:21:34	
Kosmos-656	c. 6570	-	194 X 354	51.6	00:23:46	-
Soyuz 14	c. 6570	252	195.9 X 242.7	51.62	15:17:30:28	Popovich, Artyukhin
Kosmos-670	c. 6700		217 X 307	51.6	02:23:58	-
Kosmos-672	c. 6570		198 X 239	51.8	05:22:38	-
Soyuz 15	6760	32	193.4 X 235.2	51.62	02:00:12:11	Sarafanov, Demin
Soyuz 16	6800	96	191.7 X 314.8	51.79	05:22:23:35	Filipchenko, Rukavishnikov
Zond						
Kosmos-146	c. 5375		190 X 310	51.5	08:17:01	-
Kosmos-154	c. 5375		186 X 232	51.6	02:05:23	-
Zond 4	c. 5375			-	07:00:20	-
Zond 5	c. 5375			-	06:28:26	-
Zond 6	c. 5375			-	06:18:48	-
Zond 7	5979			-	06:18:25	-
Zond 8	c. 5375			-	06:18:00	-
T2K						
Kosmos-379	c. 7495		198 X 253	51.6	4.686 days	-
Kosmos-398	c. 7255		196 X 276	51.63	Dec 10, 1995 (decayed)	

Name	Mass(kg)	Orbits	Initial Orbital Parameters (km)*	Orbital Inclination (°)	Duration (days:hrs:min:sec)**	Crew
Kosmos-434	c. 7000	-	197 X 285	51.6	3.653 days	
7K-LIE						
Kosmos-382	c. 10,380	-	320 X 5040	51.5	in orbit	-
DOS/Salyut						
<i>Salyut</i>	c. 18,500	-	200 X 222	51.6	175 days	-
Kosmos-557	c. 19,400	-	218 X 266	51.6	11:02:39	-
<i>Salyut 4</i>	c. 18,900	-	219 X 270	51.6	769.19:12	-
Almaz/Salyut						
<i>Salyut 2</i>	c. 18,500	-	215 X 260	51.6	55:02:39	
<i>Salyut 3</i>	c. 18,500	-	219 X 270	51.6	213 days	

* The orbital parameters announced by Soviet/Russian sources (shown above) differ from those tracked by Western sources because the Soviet Union used a different model of Earth

** For durations with only three figures such as 00 01 48 for the first Vostok the seconds were not included

Table IC
Nonorbital Launch Attempts Supporting the Soviet Piloted Space Program, 1951-74

Launch Date	Launch Time (Moscow Time)	Altitude (km)	Launch Vehicle	Site	Comments
July 22, 1951	1254	101	R-1V	Kapustin Yar	Dogs Dezik and Tsygan. recovered
July 29, 1951		100	R-1B	Kapustin Yar	Dogs Dezik and Lisa. both killed
Aug. 18, 1951		100	R-1B	Kapustin Yar	Smelaya and unnamed dog recovered, spectral composition studies
Aug. 19, 1951		100	R-1V	Kapustin Yar	Two dogs successfully recovered
Aug. 28, 1951		100	R-1B	Kapustin Yar	Failure. two dogs killed
Sept. 3, 1951		100	R-1B	Kapustin Yar	ZIB and unnamed dog recovered
July 2, 1954		110	R-1D	Kapustin Yar	Two dogs. one successfully recovered
July 7, 1954		110	R-1D	Kapustin Yar	Two dogs, one successfully recovered
July 26, 1954		110	R-1D	Kapustin Yar	Dogs Lisa and Ryzhik. one recovered
Jan 25, 1955		100	R-1Ye	Kapustin Yar	Two dogs, spurious payload separation at T+22 seconds
Feb 5, 1955		100	R-1Ye	Kapustin Yar	Two dogs. neither recovered
Nov 4, 1955		100	R-1Ye	Kapustin Yar	Two dogs, recovered
May 14, 1956		100	R-1Ye	Kapustin Yar	Two dogs. recovered
May 31, 1956	-	100	R-1Ye	Kapustin Yar	Two dogs, recovered, first with SOI spectrograph
June 7, 1956	-	100	R-1Ye	Kapustin Yar	Two dogs. recovered
May 16, 1957	0515	212	R-2A	Kapustin Yar	Dogs Ryzha and Darnka, both recovered
May 24, 1957	-	212	R-2A	Kapustin Yar	
Aug. 25, 1957	0627	212	R-2A	Kapustin Yar	
Aug. 31, 1957	-	212	R-2A	Kapustin Yar	
Sept 9, 1957	-	212	R-2A	Kapustin Yar	
Feb. 21, 1958	1140	473	R-5A	Kapustin Yar	
Aug. 2, 1958	-	212	R-2A	Kapustin Yar	
Aug. 13, 1958	-	212	R-2A	Kapustin Yar	
Aug. 27, 1958	0806	451	R-5A	Kapustin Yar	Dogs Palma and Pushuk. radiation research
Sept. 19, 1958	-	473	R-5A	Kapustin Yar	Two dogs
Oct. 31, 1958	1554	473	R-5A	Kapustin Yar	Two dogs
June 22, 1959	-	195	R-2A	Kapustin Yar	
July 2, 1959	0740	212	R-2A	Kapustin Yar	Dogs Otvazhnaya and Snezhinka
July 10, 1959	-	212	R-2A	Kapustin Yar	Does Otvazhnaya and unnamed. solar ultraviolet study
July 14, 1959	-	212	R-2A	Kapustin Yar	

TABLE I

bunch Date	bunch Time (Moscow Time)	Altitude (km)	bunch Vehicle	Site	Comments
June 15, 1960	0643	212	R-2A	Kapust-nYar	Does Otvazhnaya and unnamed solar ultraviolet study
June 24, 1960	-	212	R-2A	Kapust-nYar	Two dogs
Sept 16, 1960	-	210	R-2A?	Kapust-nYar	Two dogs
Sept 22, 1960	-	210	R-2A?	Kapustin Yar	Two dogs
Dec. 27, 1961	-	-	R-12	Vladimirovka	MP-1 spaceplane testbed, recovered
Mar. 21, 1963	1440	-	R-12	Kapustin Yar	M-12 spaceplane testbed, destroyed
Sept. 26, 1964	0650	-	R-5V	Kapust-nYar site 84	VAO payload with Soyuz descent apparatus, shroud breakup
July 15, 1969	-	-	R-12	Plesetsk	BOR-1 Spiral/EPOS subscale model
Aug 18, 1970	0645	-	8K82K no. 246-01	Tyura-Tam site 81L	82EV, Proton-K test

Note: There were a total of seven BOR-2 and BOR-3 suborbital launches between 1969 and 1974. No dates are known.

Selected Sources for Tables 1A, 1B, and 1C

1. E-mail correspondence: Vladimir Agapov to the author, September 27, 1996.
2. E-mail correspondence: Vladimir Agapov to the author, September 30, 1996.
3. The piloted mission parameters are from V. P. Glushko, ed., *Kosmonavtika entsiklopediya* (Moscow: Sovetskaya entsiklopediya, 1985) and V. P. Glushko, *Razvitiye raketostroyeniya i kosmonavtiki v SSSR: izdaniye vtoroye dopolnennoye* (Moscow: Mashinostroyeniye, 1981).
4. The automated mission durations are from Sergey A. Voevodin, VSA074, electronic newsletter, June 5, 1997.

Table II
Cosmonaut Selection Groups, 1960–74

Name	Birth	Resign.	Death	Space Missions
March–June 1960 (by order of the GK VVS)—VVS Group I*				
1. S. Ivan Nikolayevich Anikeyev	02-12-33	04-17-63	08-20-92	
2. M. Pavel Ivanovich Belyayev	06-26-25	01-10-70	01-10-70	Voskhod 2 (1965)
3. S. Valentin Vasilyevich Bondarenko	02-16-37	03-23-61	02-23-61	
4. S. Valery Fedorovich Bykovskiy	08-02-34	01-26-82		Vostok 5 (1963), Soyuz 22 (1976), Soyuz 31 (1978)
5. S. Valentin Ignatyevich Filatyev	01-21-30	04-17-63	09-15-90	
6. S. Yuriy Alekseyevich Gagarin	03-09-34	03-27-68	03-27-68	Vostok (1961)
7. S. Viktor Vasilyevich Gorbatko	12-03-34	08-28-82		Soyuz 7 (1969), Soyuz 24 (1977), Soyuz 37 (1980)
8. C. Anatoliy Yakovlevich Kartashov	08-25-32	04-07-62		
9. S. Yevgeniy Vasilyevich Khrunov	09-10-33	12-25-80	05-19-00	Soyuz 5 (1969)
10. C. Vladimir Mikhaylovich Komarov	03-16-27	04-24-67	04-24-67	Voskhod (1964), Soyuz 1 (1967)
11. L. Aleksey Arkhipovich Leonov	05-30-34	01-26-82		Voskhod 2 (1965), Soyuz 19 (1975)
12. S. Grigoriy Grigoryevich Nelyubov	03-21-34	05-04-63	02-18-66	
13. S. Andrian Grigoryevich Nikolayev	09-25-29	01-26-82		Vostok 3 (1963), Soyuz 9 (1970)
14. C. Pavel Romanovich Popovich	10-05-30	01-26-82		Vostok 4 (1960), Soyuz 14 (1974)
15. S. Mars Zakirovich Rafikov	09-30-33	03-24-62		
16. S. Georgiy Stepanovich Shonin	08-03-35	04-28-79	04-07-97	Soyuz 6 (1969)
17. S. German Stepanovich Titov	09-11-35	06-17-70		Vostok 2 (1961)
18. S. Valentin Stepanovich Varlamov	08-15-34	03-06-61	10-02-80	
19. S. Boris Valentinovich Volynov	12-18-34	03-17-90		Soyuz 5 (1969), Soyuz 21 (1976)
20. S. Dmitriy Alekseyevich Zaykin	04-29-32	10-25-69		
March–April 1962 (GK VVS)—TsPK Women'				
1. P. Tatyana Dmitriyevna Kuznetsova	07-14-41	10-01-69		
2. P. Valentina Leonodovna Ponomareva	09-18-33	10-01-69		
3. P. Irina Baenovna Solovyeva	09-06-37	10-01-69		
4. P. Valentina Vladimirovna Tereshkova	03-06-37	04-30-97		Vostok 6 (1963)
5. P. Zhanna Dmitriyevna Yerkina	05-06-39	10-01-69		
January 10, 1963 (GK VVS)—VVS Group 2				
<i>Pilots</i>				
1. M. Georgiy Timofeyevich Dobrovolskiy	06-01-28	06-30-71	06-30-71	Soyuz 11 (1971)

	Name	Birth	Resign.	Death	Space Missions
2	M Anatoliy Vasilyevich Filipchenko	02-26-28	01-26-82		Soyuz 7 (1969). Soyuz 16 (1974)
3	M Aleksey Aleksandrovich Cubarev	03-29-31	09-01-81		Soyuz 17 (1975). Soyuz 28 (1978)
4	M Anatoliy Petrovich Kuklin	01-03-32	09-15-75		
5	LC Vladimir Aleksandrovich Shatalov	12-08-27	06-25-71		Soyuz 4 (1969). Soyuz 8 (1969). Soyuz 10 (1971)
6	M Lev Vasilyevich Vorobyev	02-24-31	06-28-74		
	<i>Engineers</i>				
7	ME Yuriy Petrovich Artyukhin	07-22-30	01-26-82	08-04-98	Soyuz 14 (1974)
8	SLE Eduard Ivanovich Buynovskiy	02-26-36	12-11-64		
9	LCE Lev Stepanovich Demin	01-11-26	01-26-82	12-18-98	Soyuz 15 (1974)
10	SLE Vladislav Ivanovich Gulyayev	05-31-38	03-06-68	04-19-90	
11	CE Petr Ivanovich Kolodin	09-23-30	04-20-83		
12	SLE Eduard Pavlovich Kugno	06-27-35	04-16-64		
13	CE Aleksandr Nikolayevich Matinchenko	09-04-27	01-19-72	06-18-99	
14	C Anatoliy Fedorovich Voronov	06-11-30	05-25-79	10-31-93	
15	SLE Vitaliy Mikhaylovich Zholobov	06-18-37	07-01-81		Soyuz 21 (1976)
	January 25, 1964 (GK VV5)—VVS Group 2 Supplementary				
1.	LC Georgiy Tirnofeyevich Beregovoy	04-15-21	02-25-82	06-30-95	Soyuz 3 (1968)
	May-June 1964 (MK)—Voskhod'				
	<i>IAT A N SSSR</i>				
1.	Georgiy Petrovich Katys'	08-31-26	10-xx-64		
	<i>IMBP</i>				
2.	Boris Ivanovich Polyakov	Unknown	07-02-64		
	<i>GosNII AiKM</i>				
3	LC Vasily Grigoryevich Lazarev'	02-23-28	10-xx-64	12-31-90	
4.	Boris Borisovich Yegorov	11-26-37	10-xx-64	09-12-94	Voskhod (1964)
	<i>OKB-1</i>				
5.	Konstantin Petrovich Feoktistov'	02-07-26	10-xx-64		Voskhod (1964)
	<i>OKB-156</i>				
6.	Vladimir Nikolayevich Benderov	08-24-24	07-02-64	06-03-73	
	<i>TsPK</i>				
7.	Aleksey Vasilyevich Sorokin	03-30-32	10-xx-64	01-23-76	

Name	Birth	Resign.	Death	Space Missions
October 28, 1965 (CK VVS)—VVS Group 3				
<i>Pilots</i>				
1 L Leonid Denisovich Kizim	08-05-41	06-13-87		Soyuz T-3 (1980). Soyuz T-10(1984). Soyuz T-15(1986)
2 L Petr Ilich Klimuk	07-10-42	03-03-82		Soyuz 13 (1973). Soyuz 18 (1975). Soyuz 30 (1978)
3 L Aleksandr Yakovlevich Kramarenko	11-08-42	04-30-69		
4 L Aleksandr Yakovlevich Petrushenko	01-01-42	06-15-73	11-11-92	
5 L Gennadiy Vasilyevich Sarafanov	01-01-42	07-07-86		Soyuz 15 (1974)
6 L Ansar Ilgamovich Sharafutdinov	06-26-39	01-05-68		
7 L Vasilii Dmitriyevich Shcheglov	07-09-40	10-18-72	07-16-73	
8 L Aleksandr Aleksandrovich Skvortsov	06-08-42	01-05-68		
9 L Valeriy Abramovich Voloshin	04-24-42	04-09-69		
10 L Oleg Anatolyevich Yakovlev	12-31-40	05-22-73	05-02-90	
11 L Vyacheslav Dmitriyevich Zudov	01-08-42	05-14-87		Soyuz 23 (1976)
<i>Engineers</i>				
12 ME Boris Nikolayevich Belousev	07-24-30	01-05-68	06-17-98	
13 M Vladimir Aleksandrovich Degtyarev	04-09-32	01-17-66		
14 L Anatolii Pavlovich Fedorov	04-14-41	05-28-74		
15 SLE Yuriy Nikolayevich Clazkov	10-02-39	01-26-82		Soyuz 24 (1977)
16 L Vitaliy Andreyevich Grishchenko	04-26-42	02-05-68	05-04-92	
17 SLE Yevgeniy Nikolayevich Khludeyev	09-10-40	10-11-88	09-19-95	
18 CE Gennadiy Mikhaylovich Kolesnikov	10-07-36	12-16-67		
19 CE Mikhail Ivanovich Lisun	09-05-35	09-19-89		
20 SC Vlad Yevenyevich Preobrazhenskiy	02-03-39	11-18-80	10-25-93	
21 SLE Valeriy Ilich Rozhdestvenskiy	02-13-39	06-24-86		Soyuz 23 (1976)
22 CE Eduard Nikolayevich Stepanov	04-17-37	10-31-92		
January 17, 1966 (GK VVS)—VVS Group 3 Supplementary				
1. LC Vasily Grigoriyevich Lazarev	02-23-28	11-27-85	12-31-90	Soyuz 12 (1973). Soyuz 18-1 (1975)
May 23, 1966—TsKBEM'				
1 CO Sergey Nikolayevich Anokhin	03 19 10	05-27-68	04-15-86	
2 Vladimir Yefgrafovich Bugrov	01 18 33	07-12-67		
3 Gennadiy Aleksandrovich Dolgoplov	11-14 35	05-03-67		
4 Georgiy Mikhaylovich Crechko'	05 25-31	06-05-86		Soyuz 17 (1975). Soyuz 26 (1977). Soyuz T-14 (1985)
5 Valeriy Nikolayevich Kubasov	01 07-35	11-03-93		Soyuz 6 (1969). Soyuz 19 (1975). Soyuz 36 (1980)

Name	Birth	Resign.	Death	Space Missions
6 Oleg Grigoryevich Makarov	01-06-33	04-04-86		Soyuz 12 (1973), Soyuz 18-1 (1975), Soyuz 27 (1978), Soyuz T-3 (1980)
7 Vladislav Nikolayevich Volkov	11-23-35	06-30-71	06-30-71	Soyuz 7 (1969), Soyuz 11 (1971)
8 Aleksey Stanislovich Yeliseyev	07-13-34	01-10-86		Soyuz 5 (1969), Soyuz 8 (1969), Soyuz 10 (1971)
January–February 1967—TsKBEM¹⁰				
1 Nikolay Nikolayevich Rukavishnikov	09-18-32	07-07-87		Soyuz 10 (1971), Soyuz 16 (1974), Soyuz 33 (1979)
2 Vitaliy Ivanovich Sevastyanov	07-08-35	12-30-93		Soyuz 9 (1970), Soyuz 18 (1975)
April–May 1967 (GK VVS)—VVS Group 4¹¹				
<i>Pilots</i>				
1 SL Valeriy Mikhaylovich Beloborodov	10-26-39	08-29-69		
2 C Sergey Nikolayevich Caydukov	10-31-36	12-04-78		
3 SE Vladimir Vasilyevich Kovalenok	03-03-42	06-23-84		Soyuz 25 (1977), Soyuz 29 (1978), Soyuz T-4 (1981)
4 SL Vladimir Sergeyevech Kozelskiy	01-12-42	04-20-83		
5. SL Vladimir Afanasevich Lyakhov	07-20-41	08-19-94		Soyuz 32 (1979), Soyuz T-9 (1983), Soyuz T-6 (1988)
6. SL Yuriy Vasilyevich Malyshev	08-27-41	07-02-88	11-08-99	Soyuz T-2 (1980), Soyuz T-11 (1984)
7. SL Viktor Mikhaylovich Pisarev	08-15-41	05-21-68		
8. C Mikhail Vladimirovich Sologub	11-06-36	09-20-68	08-04-96	
<i>Engineers</i>				
9. ME Vladimir Borisovich Alekseyev	08-19-33	04-20-83		
10 ME Mikhail Nikolayevich Burdayev	08-27-32	04-20-83		
11. SL Vladimir Timofeyevich Isakov	04-04-40	04-20-83		
12 ME Nikolay Stepanovich Porvatkin	04-15-32	04-20-83		
May 22, 1967 (AN SSSR)				
<i>IZMIRAN AN SSSR</i>				
1. Mars Nurgaliyevich Fatkullin	05-14-39	xx-xx-70		
2 Rudolf Alekseyevich Culyayev	11-14-34	08-xx-68		
3 Ordinard Panteleymonovich Kolomyitsev	01-29-39	xx-xx-68		
<i>IPM AN SSSR</i>				
4 Valentin Gavriilovich Yershov	06-21-28	08-xx-74	02-15-98	
May 27, 1968 (MOM)—TsKBEM Group 1¹²				
1 Vladimir Grigoryevich Fartushniy ¹³	02-03-38	xx-xx-71		

	Name	Birth	Resign.	Death	Space Missions
2	Konstantin Petrovich Feoktistov ¹⁴	02-07-26	10-28-87		Voskhod (1964)
3	Georgiy Mikhaylovich Crechko ⁵	05-25-31	06-05-86		Soyuz 17 (1975). Soyuz 26 (1977). Soyuz T-14 (1985)
4	Valeriy Nikolayevich Kubasov	01-07-35	11-03-93		Soyuz 6 (1969). Soyuz 19 (1975). Soyuz 36 (1980)
5	Oleg Grigoryevich Makarov	01-06-33	04-04-86		Soyuz-12 (1973). Soyuz-18-1 (1975). Soyuz-27 (1978), Soyuz T-3 (1980)
6	Viktor Ivanovich Patsayev	06-19-33	06-30-71	06-30-71	Soyuz 11 (1971)
7	Nikolay Nikolayevich Rukavishnikov	09-18-32	07-07-87		Soyuz 10 (1971), Soyuz 16 (1974). Soyuz 33 (1979)
8	Vitaliy Ivanovich Sevastyanov	07-08-35	12-30-93		Soyuz 9 (1970). Soyuz 18 (1975)
9	Vladislav Nikolayevich Volkov	11-23-35	06-30-71	06-30-71	Soyuz 7 (1969). Soyuz 11 (1971)
10	Valeriy Aleksandrovich Yazdovskiy	07-08-30	07-01-82		
11	Aleksey Stanislavovich Yeliseyev	07-13-34	01-10-86		Soyuz 5 (1969). Soyuz 8 (1969). Soyuz 10 (1971)
April 27, 1970 (GK VVS)—VVS Group 5					
<i>Pilots</i>					
1	C Anatoliy Nikolayevich Berezovoy	04-11-42	10-21-92		Soyuz T-5 (1982)
2	SL Anatoliy Ivanovich Dedkov	07-27-44	04-20-83		
3	C Vladimir Aleksandrovich Dzhanibekov	05-13-42	06-24-86		Soyuz 27 (1978). Soyuz 39 (1981). Soyuz T-6 (1982). Soyuz T-12 (1984). Soyuz T-13 (1985)
4	SL Yuriy Fedorovich Isaulov	08-31-43	01-29-82		
5	L Vladimir Ivanovich Kozlov	10-02-45	05-28-73		
6	L Leonid Ivanovich Popov	08-31-45	06-13-87		Soyuz 35 (1980). Soyuz 40 (1981). Soyuz T-7 (1982)
7	SL Yuriy Viktorovich Romanenko	08-01-44	10-11-88		Soyuz 26 (1977). Soyuz 38 (1980). Soyuz TM-2 (1987)
<i>Engineers</i>					
8	L Nikolay Nikolayevich Fefelov	05-20-45	11-09-95		
9	Valeriy Vasilievich Illarionov	06-02-39	10-30-92	03-10-99	
March 22, 1972 (GMVK)					
<i>IMBP Group 1</i>					
1	Georgiy Vladimirovich Machinskiy	10-11-37	06-04-74		
2	Valeriy Vladimirovich Polyakov	04-27-42	06-01-95		Soyuz TM-6 (1988). Soyuz TM-18 (1994)
3	Lev Nikolayevich Smirennyy	10-25-32	11-xx-86		
<i>TsKBEM Group 2</i>					
4	Boris Dmitriyevich Andreyev	10-06-40	09-05-83		
5	Valentin Vitalyevich Lebedev ¹⁶	04-14-42	11-04-89		Soyuz 13 (1973). Soyuz T-5 (1982)
6	Yuriy Anatolyevich Ponomarev	03-24-32	04-11-83		

Name	Birth	Resign.	Death	Space Missions
<i>TsKBM Group 1</i>				
7. Valery Grigoryevich Makrushin	xx-xx-40	04-08-87		
March 27, 1973 (GMVK)				
<i>TsKBEM Group 3</i>				
1. Vladimir Viktorovich Aksenov	02-01-35	10-17-88		Soyuz 22 (1976). Soyuz T-2 (1980)
2. Aleksandr Seregeyevich Ivanchenkov	09-28-40	11-03-93		Soyuz 29 (1978). Soyuz T-6 (1982)
3. Valeriy Viktorovich Ryumin	08-16-39	10-28-87		Soyuz 25 (1977). Soyuz 32 (1979). Soyuz 35 (1980). STS-91 (1998)
4. Cennadiy Mikhaylovich Strekalov	10-28-40	01-17-95		Soyuz T-3 (1980). Soyuz T-8 (1983). Soyuz T-11 (1984). Soyuz TM-10 (1990). Soyuz TM-21 (1995)
<i>TsKBM Group 2</i>				
5. Dmitriy Andreyevich Yuyukov	02-26-41	04-08-87		

Notes

1. Anikeev, Bykovskiy, Gagarin, Corbatko, Komarov, Leonov, Nelyubov, Nikolayev, Popovich, Shonin, Titov, and Volynov joined the TsPK cosmonaut detachment by an order of the GK of VVS dated March 7, 1960. Khrunov joined on March 9, 1960. Zaykin and Filatyev joined on March 25, 1960, Belyayev, Bondarenko, and Rafikov joined on April 28, 1960, and Kartashov joined on June 17, 1960
2. Kuznetsova, Solovyeva, and Tereshkova joined the TsPK cosmonaut detachment by an order of the GK of W S dated March 12, 1962. Yerkina and Ponomareva joined on April 3, 1962
3. MK selected Lazarev, Polyakov, Sorokin, and Yegorov on May 26, 1964. On May 29, they and Katys were ordered to begin training at TsPK. On June 1, 1964, the five of them began training. Feokt-stowas selected by MK on June 11, 1964
4. Katys was selected later as a candidate cosmonaut in April 1965.
5. Lazarev was selected later as a pilot/physician on January 17, 1966.
6. Feokt-stowas reselected as a test-cosmonaut of MOM on May 27, 1968. Despite the rank of cosmonaut 3rd class, Feoktistov was not transferred to the flight-test department. He was officially named ~nstructor-test-cosmonaut on January 1, 1977, and remained so until October 28, 1987.
7. Lazarev had already been selected as a candidate cosmonaut on June 1, 1964.
8. Grechko, Kubasov, Makarov, Volkov, and Yeliseyev were reselected on May 27, 1968, as test-cosmonauts of MOM's TskBEM.
9. Grechko was selected later as a test-cosmonaut from AN SSSR on July 6, 1986.
10. Rukavishnikov was named test-engineer on February 1, 1967, while Sevastyanov was named the same on January 31, 1967. Both were reselected later as test-cosmonauts of MOM's TskBEM on May 27, 1968.
11. Alekseyev, Burdayev and Porvatkin joined by order of the GK of W S on April 12, 1967, and the remaining men joined on May 7, 1967.
12. Of the eleven, all except Fartushniy, Feokt-stov and Yazdovskiy had been selected as part of the OKB-I selections in May 1966 and January-February 1967.
13. Fartushniy was originally a researcher at the Paton Institute of Welding at Kiev, but he transferred to TskBEM upon selection.
14. Feokt-stowas selected as a Voskhod candidate cosmonaut from OKB-I on June 12, 1964. He was named a cosmonaut 3rd class on May 25, 1966, but did not officially join the test-flight department. He was officially named an NPO Energiya ~nstructor-test-cosmonaut on January 1, 1977, and remained so until October 28, 1987.
15. Grechko was selected later as a test-cosmonaut from AN SSSR on July 6, 1986.
16. Lebedev was later reselected as an NPO Energiya test-cosmonaut on November 1, 1989.

Sources

1. I. Marinin "Russian Cosmonaut Scholars" (English title) *Nouostr kosmonavtiki* 3 (January 28-February 11, 1996) 49-54
2. I. Marinin "The First Civilian Cosmonauts" (English title) *Novosti kosmonavtiki* 12-13 (June 3-30, 1996) 81-87
3. V. Semenov, I. Marinin and S. Shamsutdinov *Iz istorii kosmonavtiki: vypusk I: nabory v otryady kosmonavtov i astronautov* (Moscow: AO Videokosmos, 1995)
4. S. Yegupov and I. Karpenko "Detachment of Air Forces Cosmonauts" (English title) *Aviatsiya i kosmonavtika* no. 5 (May 1990) 46-47
5. "Air Force Cosmonaut Detachment" (English title) *Aviatsiya i kosmonavtika* no. 6 (June 1990) 46-47

Abbreviations

AN SSSR	USSR Academy of Sciences
C	Captain
CO	Colonel
CE	Captain Engineer
GK VVS	Commander in-Chief of the Air Force
CMVK	State Interdepartmental Commission for the Selection of Candidate Cosmonauts
GosNII AiKM	State Scientific Research Institute for Aviation and Space Medicine
IAT	Institute of Automation and Telemechanics
IMBP	Institute of Medico-Biological Problems
IPM	Institute of Applied Mathematics
IZMIRAN	Institute of Terrestrial Magnetism and Radio Waves
L	Lieutenant
LC	Lieutenant-Colonel
LCE	Lieutenant Colonel Engineer
M	Major
ME	Major-Engineer
MK	Mandate Commission
MOM	Ministry of Machine Building
р	Private
SG	Sergeant
SL	Senior Lieutenant
SLE	Senior Lieutenant-Engineer
TsKBEM	Central Design Bureau of Experimental Machine Building
TsKBM	Central Design Bureau of Machine Building
TsPK	Cosmonaut Training Center
VVS	Air Force

TABLE III

Table III
Administrative Organizations in the Soviet Missile and Space Programs, 1945-91

Policy

Special Committee for Reactive Technology of the USSR Council of Ministers

(established on May 13, 1946)

History This committee was established by official decree no. 1017-419ss of the USSR Council of Ministers dated May 13, 1946, to oversee the development of all long-range ballistic, cruise, and air defense missiles. The committee was dissolved in 1949. By 1957, policy aspects of the missile and space programs were moved to the Central Committee of the USSR Council of Ministers.

Designations	Date From	Date to
• Special Committee for Reactive Technology of the USSR Council of Ministers	May 1946	June 1947
• Special Committee No. 2 of the USSR Council of Ministers	June 1947	October 1949

Chairmen	Date From	Date to
• G. M. Malenkov	May 1946	March 1947
• N. A. Bulganin	March 1947	October 1949

Secretary for Defense Industries and Space of the Secretariat of the Central Committee of the Communist Party (established in June 1957)

History The position was established in June 1957 by Nikita S. Khrushchev as the locus of power in the Soviet Union shifted from the USSR Council of Ministers to the Central Committee of the Communist Party. The holder of the post was the most powerful leader in the USSR in determining Soviet space policy during the 1957-91 period.

Secretaries	Date From	Date to
• L. I. Brezhnev	July 1957	July 1960
• F. R. Kozlov	July 1960	June 1963
• L. I. Brezhnev	June 1963	March 1965
• D. F. Ustinov	March 1965	October 1976
• Y. P. Ryabov	October 1976	April 1979
• A. P. Kirilenko	April 1979	August 1983
• G. V. Romanov	August 1983	July 1985
• L. N. Zaykov	July 1985	February 1988
• O. S. Baklanov	February 1988	August 1991

Central Committee Defense Industries Department

History The origins of this department are obscure, but it clearly assumed a greater role beginning in 1958 when I. D. Serbin became its chief. Its role was to serve as doctrinal overseer of the defense industrial and space sectors. The department reported directly to the Secretary of the Central Committee for Defense Industries and Space. The department was abolished in June 1990.

Designations	Date From	Date to
• Defense Industries Department of the Central Committee	Unknown	September 1988
• Defense Department of the Central Committee	September 1988	June 1990

Chiefs	Date From	Date to
• I. D. Serbin	February 1958	February 1981
• I. F. Dmitriyev	February 1981	August 1985
• O. S. Belyakov	August 1985	June 1990

First Deputy Chief

• I. F. Dmitriyev	1965	February 1981
• N. M. Luzhin	1988	June 1990

Sector Head for Space

• B. A. Stroganov	1960s	Unknown
-------------------	-------	---------

Instructor for Space

• V. A. Popov	1960s	Unknown
---------------	-------	---------

*Implementation***Military-Industrial Commission (VPK) of the Presidium of the USSR Council of Ministers** (established on April 14, 1955)

History: VPK traces its ancestry back to the Third Chief Directorate (TGU) of the USSR Council of Ministers, which was established on February 3, 1951, to manage the development of all Soviet missile weapons (cruise, ballistic, air defense, and naval). On July 1, 1953, the TGU was combined with the First Chief Directorate of the USSR Council of Ministers to form the new Ministry of Medium Machine Building (MSM). The TGU, now known as GlavSpetsMash (Chief Directorate of Special Machine Building), became a subordinate department to MSM. On April 14, 1955, GlavSpetsMash was separated from MSM. A portion, including all subordinate design bureaus and subdivisions, was moved to the Ministry of Defense Industries. Simultaneously, the remainder (that is, the old structure of the TGU) was used as the basis for the new Special Committee for Armaments for the Army and VMF (the Navy) and subordinated directly to the USSR Council of Ministers. From then on, this Special Committee supervised all tactical and strategic missile programs in the Soviet Union. In December 1957, this Special Committee was renamed the Commission of the Presidium of the USSR Council of Ministers for Military-Industrial Issues or more familiarly, the Military-Industrial Commission (VPK). Its supervisory duties were expanded from missiles to the entire Soviet defense industry.

Designations

	Date From	Date to
• Special Committee for Armaments for the Army and VMF of the USSR Council of Ministers	April 1955	December 1957
• Commission of the Presidium of the USSR Council of Ministers for Military-Industrial Issues	December 1957	1986
• State Commission of the USSR Council of Ministers for Military-Industrial Issues	1986	August 1991

Chairmen

• V. M. Ryabikov	April 1955	December 1957
• D. F. Ustinov	December 1957	March 1963
• L. V. Smirnov	March 1963	December 1985
• Yu. D. Maslyukov	December 1985	February 1988
• I. S. Belousey	February 1988	January 1991
• Yu. D. Maslyukov	January 1991	August 1991

First Deputy Chairmen

• G. A. Titov	April 1955	December 1957
• S. I. Vetoshkin	December 1957	1964
• N. S. Stroyev	1977	1987
• V. L. Koblov	1987	August 1991

Deputy Chairmen

	Date From	Date to
• A. K. Repin	April 1955	Unknown
• A. N. Shchukin	April 1955	1969
• G. N. Pashkov	December 1957	1970
• G. A. Titov	December 1957	1974
• N. S. Stroyev	1966	1977
• L. I. Gorshkov	1966	1970s
• S. A. Arzhakov	Unknown	Unknown

CHALLENGE TO APOLLO

TABLE III

• B. A. Komissarov	1970s	Unknown
• A. I. Voznesenskiy	Unknown	Unknown
• L. B. Vasilyev	March 1988	Unknown

Ministry of Armaments (MV) (established on January 11, 1939)

History: This ministry was originally established in January 1939, having being split off from the People's Commissariat of Defense Industry. Through its various incarnations, it managed the development of the Soviet ballistic missile and space programs from 1946 to 1965 via its subordinate Seventh Chief Directorate. In March 1965, the Seventh Chief Directorate was removed from the ministry and became the basis for the new Ministry of General Machine Building. Since that time, the ministry had little involvement in the ballistic missile and space programs.

Designations	Date From	Date to
• People's Commissariat of Armaments (NKA)	January 1939	March 1946
• Ministry of Armaments (MV)	March 1946	March 1953
• Ministry of Defense Industry (MOP)	March 1953	December 1957
• State Committee for Defense Technology (GKOT)	December 1957	March 1965
 People's Commissars/Ministers/Chairmen		
• B. L. Vannikov	January 1939	June 1941
• D. F. Ustinov	June 1941	December 1957
• A. V. Domrachev	December 1957	March 1958
• K. N. Rudnev	March 1958	June 1961
• L. V. Smirnov	June 1961	March 1963
• S. A. Zverev	March 1963	March 1965
 First Deputies		
• V. M. Ryabikov	1940	February 1951
• A. V. Domrachev	1951	1957
• S. I. Vetoshkin	1955	December 1957
• S. A. Zverev	December 1959	March 1963
• G. A. Tyulin	June 1961	March 1965
 Deputies		
• V. N. Novikov	1941	1948
• K. M. Gerasimov	1949	1951
• I. G. Zubovich	October 1949	March 1953
• A. V. Domrachev	1951	1951
• S. A. Zverev	March 1952	March 1953
• K. N. Rudnev	May 1952	March 1958
• P. N. Goremykin	August 1953	April 1955
• K. M. Gerasimov	1954	1957
• V. N. Novikov	1954	April 1955
• S. A. Zverev	March 1954	December 1959
• L. A. Grishin	March 1958	October 1960
• G. N. Kozhevnikov	Late 1950s	Unknown
• V. M. Larionov	Late 1950s	Unknown
• S. N. Makhonin	Late 1950s	Unknown
• L. V. Smirnov	February 1961	June 1961
 Chiefs of the Chief Directorates		
• N. E. Nosovskiy (First GU)	1940	1947
• K. M. Gerasimov	1941	1949
• K. M. Gerasimov	1951	1954
• L. A. Grishin	October 1952	March 1958
• S. A. Zverev (Second GU)	March 1952	March 1952
• S. A. Zverev (Eighth GU)	March 1952	March 1954
• V. N. Novikov (Fifth GU)	1953	1953

• P. V. Finogenov (Sixth GU)	1963	March 1965
• S. I. Vetoshkin (Seventh CU)	1939	October 1949
• I. G. Zubovich (Seventh GU)	October 1949	August 1951
• L. V. Smirnov (Seventh CU)	August 1951	June 1952
• M. S. Ryazanskiy (Seventh CU)	June 1952	1954
• V. A. Koiychev (Seventh GU)	December 1955	Unknown
• A. S. Tomilin (Seventh CU)	Late 1950s	Unknown
• B. A. Kornissarov (Seventh GU)	Early 1960s	Unknown

Ministry of Aviation Industry (MAP) (established on January 11, 1939)

History This ministry was originally established in January 1939 having being split off from the Peoples Commissariat of Defense Industry. As more and more aviation organizations began participating in the missile and space sector beginning the late 1950s the ministry took a greater role in such efforts. Note that from March to August 1953, it was part of the Ministry of Defense Industries. Many of the space and missile organizations were transferred from the Ministry of Aviation Industry to the new Ministry of General Machine Building upon the latter's formation in March 1965.

Designations	Date From	Date to
• Peoples Commissariat of Aviation Industry (NKAP)	January 1939	March 1946
• Ministry of Aviation Industry (MAP)	March 1946	December 1957
• State Committee for Aviation Technology (GKAT)	December 1957	March 1965
• Ministry of Aviation Industry (MAP)	March 1965	January 1992

People's Commissars/Ministers/Chairmen

• M. M. Kaganovich	January 1939	January 1940
• A. I. Shakhurin	January 1940	March 1946
• M. V. Khrunichev	March 1946	March 1953
• P. V. Dementyev	August 1953	May 1977
• V. A. Kazakov	June 1977	February 1981
• I. S. Silayev	February 1981	November 1985
• A. S. Systov	November 1985	November 1991

First Deputies

• P. V. Dementyev	1941	1946
• V. P. Balandin	August 1953	1957
• S. M. Leshchenko	1957	1964
• V. A. Kozlov	1964	1965
• S. I. Kadyshev	1965	1974
• V. A. Kazakov	1974	June 1977
• I. S. Silayev	1977	December 1980
• A. S. Systov	February 1981	November 1985

Ministry of General Machine Building (MOM) (established on March 2, 1965)

History This ministry was established on the basis of the Seventh Chief Directorate of the State Committee for Defense Technology (CKOT) which oversaw all ballistic missile and space programs. MOM managed the development of almost all Soviet ballistic missiles and spacecraft from 1965 to 1991. It was officially abolished in November 1991.

Ministers	Date From	Date to
• S. A. Afanasyev	March 1965	April 1983
• O. D. Baklanov	April 1983	February 1988
• V. K. Doguzhiyev	April 1988	July 1989
• O. N. Shishkin	July 1989	August 1991
• R. R. Kiryushin	August 1991	November 1991

First Deputy Ministers	Date From	Date to
• G. A. Tyulin	March 1965	1976

CHALLENGE TO APOLLO

TABLE III

• B. V. Balmont	1976	February 1981
• O. D. Baklanov	February 1981	April 1983
• V. N. Konovalov	April 1983	1987
• V. K. Doguzhiyev	1987	March 1988
• O. N. Shishkin	February 1988	July 1989
• R. R. Kiryushin	July 1989	August 1991

Deputy Ministers

• V. Ya. Litvinov	March 1965	1973
• G. M. Tabakov (engines)	March 1965	1981
• Ye. V. Mazur (construction)	March 1965	1982
• G. R. Udarov (launch complexes)	March 1965	1979
• N. D. Khokhlov (quality)	March 1965	1983
• L. I. Gusev (guidance)	March 1965	1965
• M. A. Brezhnev (guidance systems)	1965	Unknown
• B. V. Balmont	1973	1976
• V. V. Lobanov (finances)	January 1974	1980s
• O. D. Baklanov	1976	1981
• V. N. Konovalov (naval)	Unknown	April 1983
• V. N. Soshin (construction)	1982	Late 1980s
• V. K. Doguzhiyev	1983	1987
• Ye. A. Zhelonov	1984	Unknown
• A. S. Matrenin (quality)	1984	November 1991
• O. N. Shishkin (space)	Unknown	February 1988
• G. F. Grigorenko	1980s	November 1991
• Yu. N. Koptev	Unknown	November 1991
• A. Ye. Shestakov	Unknown	November 1991
• R. R. Kiryushin	Unknown	1989
• V. Ye. Sokolov	Unknown	1990s
• S. S. Vanin (complexes)	Unknown	1980s
• V. N. Ivanov	Mid-1980s	Unknown

Chiefs of Chief Directorates

• K. A. Kerimov (Third GU)	March 1965	June 1974
• V. D. Vachnadze (Third GU)	June 1974	June 1977
• A. K. Vanitskiy	1974	1976
• B. V. Balmont (Sixth GU)	1965	1972
• B. V. Balmont (Eighth GU)	1972	1973
• A. S. Matrenin (Seventh GU)	1969	1984
• A. S. Kirillov	June 1969	November 1977
• Yu. N. Koptev (Third GU)	Mid-1980s	Unknown
• V. A. Andreyev (First GU)	January 1989	Unknown
• A. I. Dunayev (Thirteenth GU)	June 1985	November 1991
• I. N. Gabelko	Unknown	November 1991

Ministry of Medium Machine Building (MSM) (established on July 1, 1953)

History: This ministry was responsible for the manufacture of all Soviet nuclear warheads from 1953 to 1991. Its lineage goes back to August 20, 1945, with the formation of the First Chief Directorate (PGU) of the USSR Council of Ministers. On March 16, 1953, the PGU absorbed the Second Chief Directorate of the Council of Ministers. On July 1, 1953, the PGU and the Third Chief Directorate combined to form the Ministry of Medium Machine Building (MSM). MSM oversaw all missile programs through its subordinate GlavSpetsMash between July 1953 and April 1955.

Designations

• First Chief Directorate	Date From August 1945	Date to June 1953
• Ministry of Medium Machine Building (MSM)	July 1953	March 1963
• State Committee for Medium Machine Building (GKSM)	March 1963	March 1965
• Ministry of Medium Machine Building (MSM)	March 1965	June 1989

Chiefs/Ministers/Chairmen

• B. L. Vannikov	August 1945	June 1953
• V. A. Malyshev	July 1953	February 1955
• A. P. Zavenyagin	February 1955	December 1956
• M. G. Pervukhin	April 1957	July 1957
• Ya. P. Slavskiy	July 1957	November 1986
• L. D. Ryabev	November 1986	June 1989

State Commissions in the Early Space and Missile Programs

Product	Chairmen	Dates
A-4	N. D. Yakovlev	1947
R-1	S. I. Vetoshkin	1948-50
R-2	C. I. Ioffe	1950-51
R-5	P. A. Degtyarev	1953-55
R-11	A. I. Nesterenko	1953-55
R-5M	P. A. Degtyarev	1954-56
R-7	V. M. Ryabikov	August 1956-57
	K. N. Rudnev	1957-59
R-7A	M. I. Nedelin, A. G. Mrykin, A. I. Nesterenko, K. V. Cerchik	1959-60
Scientific vertical launches	A. A. Blagonravov	1951-61
Sputnik	V. M. Ryabikov	1957-58
Luna	K. N. Rudnev	1958-60
	M. I. Nedelin	1960
	G. A. Tyulin	1963-76

Product	Chairmen	Dates
Vostok	M. I. Nedelin	1960
	K. N. Rudnev	1960-61
	L. V. Smirnov	1961-63
	G. A. Tyulin	1963
Voskhod	C. A. Tyulin	August 1964-66
Soyuz, DOS/Salyut, Mir	K. A. Kerimov	October 1966-91
	V. L. Ivanov	1991-96
UR-500K-L1	C. A. Tyulin	December 1966-70
NI-L3	S. A. Afanasyev	1967-72
T2K	A. A. Maksimov	1970-71
Almaz/Salyut	M. G. Grigoryev	1973-77
MP-1	A. G. Zakharov	1961

Clients

Ministry of Defense (established in postwar form on February 25, 1946)

History The Ministry of Defense was the primary client of the Soviet missile and space programs. Its subordinate Strategic Missile Forces managed all missile and space operations during 1959-81. The Deputy Minister of Defense for Armaments was responsible for weapons (and spacecraft) procurement. Note that between 1960 and 1970, N. N. Alekseyev was the Chairman of the Scientific-Technical Committee (NTK) of the General Staff of the Ministry of Defense, essentially performing the same duties as the Deputy Minister of Defense for Armaments, a post that did not exist during that period.

Designations

• Ministry of Armed Forces (MVS)	Date From February 1946	Date to February 1950
• Ministry of War	February 1950	March 1953
• Ministry of Defense (MO)	March 1953	January 1992

CHALLENGE TO APOLLO

TABLE III

Ministers

• I. V. Stalin	February 1946	March 1947
• N. A. Bulganin	March 1947	March 1949
• A. M. Vasilyevskiy	March 1949	March 1953
• N. A. Bulganin	March 1953	February 1955
• C. K. Zhukov	February 1955	October 1957
• R. Ya. Malinovskiy	October 1957	March 1967
• A. A. Crechko	April 1967	April 1976
• D. F. Ustinov	April 1976	December 1984
• S. L. Sokolov	December 1984	May 1987
• D. T. Yazov	May 1987	September 1991
• Ye. I. Shaposhnikov	September 1991	December 1991

Deputy Ministers of Defense for Armaments

• M. I. Nedelin	March 1955	December 1959
• N. N. Alekseyev	1960	1978
• V. M. Shabanov	1978	Unknown

Missile Forces of Strategic Designation (RVSN) (established on December 17, 1959)

History. RVSN managed all Soviet missile and space operations during 1959–81

Commanders	Date From	Date to
• M. I. Nedelin	December 1959	October 1960
• K. S. Moskalenko	October 1960	April 1962
• S. S. Biryuzov	April 1962	March 1963
• N. I. Krylov	March 1963	February 1972
• V. F. Tolubko	February 1972	July 1985
• Yu. P. Maksimov	July 1985	August 1992

First Deputy Commanders

• V. F. Tolubko	March 1960	1968
• M. G. Grigoryev	1968	December 1981
• Yu. A. Yashin	December 1981	1989
• A. P. Volkov	1989	1994

Chiefs of the Scientific-Technical Committee (NTK)

• V. P. Morozov	June 1962	1967
• A. A. Vasilyev	1967	1969
• A. S. Kalashnikov	1969	1974
• S. A. Sergeyev	1974	1979
• V. M. Ryumkin	1979	1989
• V. C. Popov	1989	

Chief Directorate of Reactive Armaments (GURVO) (established on May 13, 1946)

History. From 1946 GURVO in its various incarnations oversaw the procurement of ballistic missiles into armaments of the Strategic Missile forces. Between 1960 and 1970 GURVO's subordinate TsUKOS was the primary client of the Soviet space program.

Designations	Date From	Date to
• 4th Directorate of the Chief Artillery Directorate	May 1946	April 1953
• Directorate of the Deputy Commander of Artillery (UZKA)	April 1953	March 1955
• Directorate of the Commander of Reactive Armaments (UNRV)	March 1955	December 1959
• Chief Directorate of Reactive Armaments (CURVO)	December 1959	1993

Commanders	Date From	Date to
• A. I. Sokolov	May 1946	August 1954
• A. I. Semenov	August 1954	August 1964

• A. A. Vasilyev	August 1964	1967
• N. N. Smirnitkiy	1967	December 1975
• Yu. A. Pichugin	December 1975	1984
• A. A. Ryazhskikh	1984	1993

Chief Directorate of Space Assets (GUKOS) (established in October 1964)

History In October 1964 the Third Directorate of the Chief Directorate of Reactive Armaments (CURVO) of the Strategic Missile Forces (RVSN) was reorganized into TsUKOS. In March 1970 TsUKOS was combined with the Center for Leading the Development and Production of Space Assets (itself established in March 1963 within GURVO) to form the new CUKOS and subordinated to RVSN. On November 10 1981 GUKOS was separated from RVSN and subordinated directly to the Ministry of Defense. GUKOS was the primary client for the Soviet space program responsible for all operational aspects including tracking and launch activities. It had jurisdiction over NIIP 5 (Tyura Tam) military units at Mirnyy (Plesetsk) the Command Measurement Complex (KIK) the A F Mozhayskiy Military Academy TsNII 50 28 Arsenal (Karian Stroganov) and military representatives to research and development organizations.

Designations	Date From	Date to
• Third Directorate of the Chief Directorate of Reactive Armaments	September 1960	October 1964
• Central Directorate of Space Assets (TsUKOS)	October 1964	March 1970
• Chief Directorate of Space Assets (GUKOS)	March 1970	November 1986
• Directorate of the Chief of Space Assets (UNKS)	November 1986	August 1992

Commanders	Date From	Date to
• K. A. Kerimov	September 1960	March 1965
• A. G. Karas	March 1965	January 1979
• A. A. Maksimov	January 1979	1989
• V. L. Ivanov	1989	October 1996

First Deputy Commanders	Date From	Date to
• A. A. Maksimov	Unknown	January 1979
• G. S. Titov	July 1979	October 1991
• V. L. Ivanov	1984	1989

Command-Measurement Complex Center (TsKIK)

(established by order dated September 3, 1956)

History The Command Measurement Complex (KIK) was the ground communications network for the Soviet space program. It was established on the basis of the Range Measurement Complex network of tracking stations established for early R-7 ICBM launches. In 1956-57 the Range Measurement Complex was reconfigured into the KIK to support the launch of the Object D satellite (launched as Sputnik 3). The KIK including its main center the Command Measurement Complex Center (TsKIK) was subordinate to NII-4 until March 7 1962 when it was subordinated directly to the Strategic Missile Forces (RVSN). The TsKIK began operations on July 12 1957. In January 1982 the TsKIK was reorganized into the Chief Scientific-Research Testing Center for Space Assets of the Ministry of Defense (GNIITs KS MO). The center operated tracking for all Soviet era space operations via its various Scientific Measurement Points (NIP) spread across the Soviet Union.

Commanders of Military Unit No. 32103/TsKIK	Date From	Date to
• A. A. Vitruk	July 1957	1959
• A. G. Karas	1959	March 1965
• I. I. Spitsa	March 1965	January 1973
• I. D. Statsenko	January 1973	January 1976
• N. F. Shlykov	January 1976	1989
• V. N. Ivanov	1989	1989

Scientific-Measurement Points (NIP)	Location
• IP-1	Tyura-Tam
• IP-2	Makat
• IP-3	Sary-Shagan

CHALLENGE TO APOLLO

TABLE III

• NIP-4	Yeniseyesk
• IP-5	Iskhup
• NIP-6	Yelizovo (near Petropavlovsk Kamchatka)
• IP-7	Klyuchi
• NIP-9	Krasnoye selo (near Leningrad)
• NIP-10	Simferopol
• IP-11	Sartychaly
• NIP-12	Kolpashevo
• NIP-13	Ulan Ude
• NIP-14	Shchelkovo (near Moscow)
• NIP-15	TsDRS Galenkiy (near Ussuriysk)
• NIP-16	TsDKS Yevpatoriya
• NIP-17	Yakutsk
• NIP-18	Vorkuta
• NIP-19	Dunyevtzy Khmel'nitskaya oblast
• NIP-20	Solnechnyi (near Komsomolsk na Amur)
• NIP-22	Yevpatoriya?
• IP-41Ye	Simeiz
• IP-42Ye	Moscow

Air Force (VVS)

History The Deputy Chief of Combat Preparations of the Air Force was directly responsible for the selection and training of cosmonauts and the selection of crews for all piloted space missions. By an order dated April 10, 1962, the holder of these duties was made the General Staff Deputy Chief for Space. On March 29, 1966, the holder of these duties was made the Commander-in-Chief's Aide for Space. The Aide for Space officially supervised the Cosmonaut Training Center, the Air Force Biomedical Service, and the Solar Service.

Commanders-in-Chief	Date From	Date to
• K. A. Vershinin	1946	1949
• P. F. Zhigarev	1949	1957
• K. A. Vershinin	1957	March 1969
• P. S. Kutakhov	March 1969	December 1984
• A. N. Yefimov	December 1984	1990
• Ye. A. Shaposhnikov	1990	August 1991
First Deputy Commanders		
• S. I. Rudenko	1958	July 1968
• P. S. Kutakhov	July 1968	March 1969
• A. N. Yefimov	March 1969	December 1984
Deputy Chiefs of Combat Preparations		
• N. P. Kamanin	1958	October 1971
• V. A. Shatalov	October 1971	June 1986

Science Sector

USSR Academy of Sciences (AN SSSR)

History The Russian Academy of Sciences was established on January 28, 1724. In 1925, it was renamed the USSR Academy of Sciences.

Presidents	Date From	Date to
• S. I. Vavilov	July 1945	January 1951
• A. N. Nesmeyanov	January 1951	May 1961
• M. V. Keldysh	May 1961	November 1975
• A. P. Aleksandrov	November 1975	1986
• V. A. Kotel'nikov	1986	October 1986
• G. I. Marchuk	October 1986	1991

Launch Sites

Kapuatin Yar/State Central Test Range No. 4 (GTSP-4)

(established by order dated May 13, 1946)

History: The specific location of the range was confirmed by an order dated July 27, 1947

Commanders	Date From	Date to
• V. I. Voznyuk	August 1946	April 1973
• Yu. A. Pichugin	April 1973	1975
• P. C. Degtyarenko	1975	September 1981
• N. Ya. Lopatin	September 1981	1983
• N. V. Mazyarkin	1983	1991

Tyura-Tam/Scientific Research and Testing Range No. 5 (NIIP-5)

(established on June 2, 1955)

History: On January 29, 1958, the town of Zarya was renamed Leninsk. In December 1995, Leninsk was renamed Baikonur (also spelled Baykonur)

Commanders	Date From	Date to
• A. I. Nesterenko	June 1955	July 1958
• K. V. Gerchik	July 1958	April 1961
• A. G. Zakharov	May 1961	March 1965
• A. A. Kurushin	March 1965	1973
• V. I. Fadeyev	1973	1978
• Yu. N. Sergunin	1978	1983
• Yu. A. Zhukov	1983	1989
• A. L. Kryzhko	1989	1991

Mirnyy/Scientific-Research and Testing Range No. 53 (NIIP-53)

(established on January 11, 1957)

History: On August 30, 1963, this became a space launch center. In 1982, one portion of NIIP-53 became GTsIPKS-1278.

Commanders	Date From	Date to
• M. G. Grigoryev	January 1957	1962
• S. F. Shtanko	1962	1963
• C. Ye. Alpaidze	1963	August 1975
• Yu. A. Yashin	August 1975	1979
• V. L. Ivanov	1979	1984
• C. A. Kolesnikov	1984	1985
• I. I. Oleymk	1985	1991

CHALLENGE TO APOLLO

TABLE III

Selected Sources

1. Peter Almquist, *Red Forge: Soviet Military Industry Since 1965* (New York: Columbia University Press, 1990).
2. Central Intelligence Agency, *Directory of Soviet Officials, Vol. I: Personnel in the Communist Party, Government, and Mass Organizations of the U.S.S.R. and R.S.F.S.R.* (Washington, DC: Department of State, 1960).
3. B. Ye. Chertok, *Rakety i lyudi* (Moscow: Mashinostroyeniye, 1994).
4. B. Ye. Chertok, *Rakety i lyudi: Fili Podlipki Tyuratam* (Moscow: Mashinostroyeniye, 1996).
5. B. Ye. Chertok, *Rakety i lyudi: goryachiye dni kholodnoy voyny* (Moscow: Mashinostroyeniye, 1997).
6. Julian Cooper, "The Elite of the Defence Industry Complex," in David Lane, ed., *Elites and Political Power* (London: Edward Elgar, 1988), pp. 167-87.
7. Edward L. Crowley, Andrew I. Lebed, and Dr. Heinrich E. Schulz, eds., *Party and Government Officials of the Soviet Union 1917-1967* (Metuchen, NJ: The Scarecrow Press, 1968).
8. Grigoriy Kisunko, *Sekretnaya zona* (Moscow: Sovremennik, 1996).
9. Christian Lardier, *L'Astronautique Soviétique* (Paris: Armand Colin, 1992).
10. Yu. P. Maksimov, ed., *Raketnyye voyska strategicheskogo naznacheniya* (Moscow: RVSN, 1992).
11. I. D. Sergeyev, ed., *Khronika osnovnykh sobityy istorii raketnykh voysk strategicheskogo naznacheniya* (Moscow: TsPIK, 1994).
12. Michel Tatu, *Power in the Kremlin: From Khrushchev's Decline to Collective Leadership* (London: Collins, 1970).

1

Table IV
Major Contractor Organizations in the Soviet Space Program, 1945-74

Designer Bureau Name Established Location	Designations	Chief/General Designers	History
Spacecraft and launch <i>Vehicles</i>			
Babakin OKB-301 July 1, 1937 Khimki	<ul style="list-style-type: none"> • OKB-301 (1945-60) • GSNMZ Lavochkin (1960-62) • OKE-52 Branch No. 3 (1962-65) • GSNMZ Lavochkin (1965-74) • NPO Lavochkin (1974-) 	<ul style="list-style-type: none"> A. A. Dubrovniin (1937-39) S. A. Lavochkin (1939-60) M. M. Pashinin (1960-62) A. I. Eidis (1962-65) C. N. Babakin (1965-71) S. S. Kryukov (1971-77) V. M. Kovtunenکو (1977-95) V. A. Serebrennikov (1995-97) S. P. Kulikov (1997-) 	This was established at Plant No. 301. During the war it was transferred to other locations but returned to Khimki in October 1945. OKB-301 was Branch No. 3 of OKB-52 from December 18, 1962 to March 2, 1965. At various times this entity specialized in aircraft (1940s), missiles (1950s), and robotic spacecraft (from 1965). In 1974 OKB and the plant merged to form NPO Lavochkin.
Chelomey OKB-St August 8, 1955 Reutov	<ul style="list-style-type: none"> • OKB-52 (1955-66) • TsKBM (1966-83) • NPO Mashinostroyeniya (1983-) 	<ul style="list-style-type: none"> V. N. Chelomey (1955-84) C. A. Yefremov (1984-) 	Special Design Group No. 10 (SKC 10) was established at Plant No. 500 at Tushino on June 9, 1954. On August 8, 1955, the group became OKB 52, moving in 1956 to the Reutov Machine Building Plant to focus on naval cruise missiles. It was subordinate to GSNII 642 from November 6, 1957 to March 8, 1958, but their roles reversed when GSNII 642 dissolved and turned into a plant. During 1958-59, OKB-52 began work on spacecraft and ballistic missiles.
Iosifyan NII-627 September 1941 Moscow	<ul style="list-style-type: none"> • NII-627 (1944-53) ■ VNII EM (1953-92) • NPP VNII ElektroMekhaniki (1992-) 	<ul style="list-style-type: none"> A. C. Iosifyan (1941-74) N. N. Shermetyevskiy (1974-91) Yu. N. Trifonov (1993-) 	This was established at Plant No. 627 in Moscow in 1941 and became NII in 1944. It originally developed power generators for ballistic missiles in the 1940s and 1950s before moving into spacecraft in the 1960s after inheriting the Meteor program from OKB-586.
Korolev OKB-I August 26, 1946 Kaliningrad	<ul style="list-style-type: none"> • NII-88 SKB Dept. No. 3 (1946-50) • NII-88 OKB-I (1950-56) ■ OKB-I (1956-66) 	<ul style="list-style-type: none"> S. P. Korolev (1946-66) V. P. Mishin (1966-74) V. P. Glushko (1974-89) Yu. P. Semenov (1989-) 	This was established as Dept. No. 3 of NII-88 at Plant n88 on August 26, 1946, to develop long-range ballistic missiles. On April 24, 1950, this department was restructured into OKB-I, still subordinate to NII-88. On August 14, 1956, OKB-I became independent of NII-88. On May

Designer Bureau Name Established Location	Designations	Chief/General Designers	History
OKB-I cont.	<ul style="list-style-type: none"> • TsKBEM (1966-74) • NPO Energiya (1974-91) • Korolev NPO Energiya (1991-94) • Korolev AOOT RKK Energiya (1994-) 		<p>22 1974 OKB I (then called TsKBEM) merged with KB EnergoMash to form the new NPO Energiya KB EnergoMash separated from NPO Energiya on January 19 1990 From 1945 until the early 1960s the primary thematic thrust was the development of long-range ballistic missiles From the early 1960s on the organization focused primarily on piloted and robotic spacecraft</p>
Kozlov TsSKB July 23, 1959 Kuybyshev	<ul style="list-style-type: none"> • OKB-I SKO No. 25 (1959-60) • OKB-I Branch No. 3 (1960-66) • OKB-I (1956-66) • TsKBEM Kuybyshev Branch (1966-74) • TsSKB (1974-96) • GNPRTs TsKB-Progress (1996-) 	D. I. Kozlov (1959-)	<p>This was established on July 23, 1959, as Special Design Department No. 25 (SKO-25) at Plant No. 1 to supervise the manufacture of the R-7 and derivative launch vehicles, becoming OKB-I Branch No. 3 on July 17, 1960. It inherited all work on robotic reconnaissance satellites and R-7-based launch vehicles in 1964 from OKB-I, although it remained subordinate to its parent entity until July 30, 1974, when it became independent as TsSKB. It combined with the production facility Progress Plant (formerly Plant No. 1) on April 12, 1996, to form GNPRTs TsSKB-Progress</p>
Mikoyan OKB-155 December 8 1939 Moscow	<ul style="list-style-type: none"> • OKO (1939-42) • OKB-155 (1942-66) • MMZ Zenit (1966-71) • MMZ Mikoyan (1971-78) • Mikoyan ANPK MiG 	A. I. Mikoyan (1939-71) R. A. Belyakov (1971-)	<p>This was established as Experimental Design Section (OKO) in December 1939. It was evacuated to Kuybyshev in October 1941 but returned to Moscow in March 1942 at Plant No. 480. On March 16, 1942, it was renamed Plant No. 155. It worked on the Spiral spaceplane in 1965-78.</p>
Myasishchev OKB-23 March 24, 1951 Fili	<ul style="list-style-type: none"> • OKB-23 (1951-60) • OKB-52/TsKBM Branch No. 1 (1960-81) • NPO Energiya KB Salyut (1981-88) • NPO EM KB Salyut • KB Salyut • GKNPTs Khrunchev KB Salyut (1993-) 	V. M. Myasishchev (1951-60) V. N. Bugaysky (1960-73) D. A. Polukhin (1973-93) A. S. Moysheyev (1993-94) A. K. Nedayvoda (1994-)	<p>This was established at Fili in Moscow at Plant No. 23 (established as a factory in April 1916) to develop long-range bombers and cruise missiles. On October 3, 1960, it became a branch of OKB-52 and began developing spacecraft, ICBMs, and space launch vehicles. The aviation database went to OKB-51 and OKB-156. This organization remained an OKB-52 branch until June 30, 1981, when it became a branch of NPO Energiya. On June 22, 1988, it separated from NPO Energiya and formed NPO EM. This NPO eventually dissolved, and KB Salyut became independent for a short while before joining with the M. V. Khrunchev Machine Building Plant to form GKNPTs Khrunchev on June 7, 1993.</p>

Designer Bureau Name Established Location	Designations	Chief/General Designers	History
Raspletin KB-1 September 8, 1947 Moscow	<ul style="list-style-type: none"> • SB-1 (1947–50) • KB-1 • MKB Strela • TsKB Almaz (1967–71) • NPO Almaz (1971–95) • TsKB Almaz (1995–) 	P. N. Kuksenko (1947–53) S. L. Beriya (1947–53) S. M. Vladimirov (1953) A. A. Raspletin (1953–67) B. V. Bunkin (1967–)	This was formed in 1947 to work on the Kometa system. In August 1950, it was reorganized into KB-1 to work on the Berkut Moscow defense system. In April 1955, three subdivisions were created within KB-1, one of which, SKB-31, was a primary subdivision of KB-1 and headed by Raspletin since its founding. From 1960 on, when Raspletin became KB-1 Director, SKB-31 was headed by B. V. Bunkin. It worked on robotic military reconnaissance satellites via its subordinate OKB-41
Reshetnev OKB-10 June 4, 1959 Krasnoyarsk	<ul style="list-style-type: none"> • OKB-1 Branch (1959–60) • OKB-1 Branch No. 2 (1960–61) • OKB-10 (1961–66) • KB PM (1966–77) • NPO Prikladnoy mekhaniki (1977–96) • Reshetnev NPO Prikladnoy mekhaniki (1996–) 	M. F. Reshetnev (1961–96) A. G. Kozlov (1996–)	This was formed at Plant No. 1001 to supervise ICBM production for OKB-1 but it inherited a number of communications satellite projects from OKB-586 and OKB-1 in 1962–67 and began indigenous space projects. On December 18, 1961, it separated from OKB-1 and became an independent entity (Prikladnoy mekhaniki means Applied Mechanics)
Savin OKB-41 April 1955 Moscow	<ul style="list-style-type: none"> • KB-1 SKB-41 (1955–62) • KB-1 OKB-41 • KB-1 OKB Kometa • TsNII Kometa (1973–??) • TsNPO Kometa 	A. A. Kolosov A. I. Savin (1962–)	This was established in 1955 as SKB-41, a subdivision of KB-1, to focus on rocket armaments for aircraft. In 1973, OKB-41 (by then named OKB Kometa) detached from KB-1 (by then MKB Strela) and became an independent organization, TsNII Kometa. It worked on robotic military EORSATs, RORSATs, and ASATs.
Tsybin OKB-256 May 23, 1955 Dubna	<ul style="list-style-type: none"> • OKB-256 (1955–59) 	P. V. Tsybin (1955–59)	This was established at Plant No. 256 in Dubna. When OKB-256 dissolved on October 1, 1959, the database on spaceplane research was transferred to OKB-155. OKB-256 was absorbed by OKB-23, while the plant went to OKB-2-155. Tsybin ended up at OKB-1 in 1960.
Tyurin TsKB-7 November 21, 1949 Leningrad	<ul style="list-style-type: none"> • TsKB-7 (1949–67) • Frunze KB Arsenal (1967–) 	N. P. Antonov (1949–52) P. A. Tyurin (1953–81) S. P. Parnyakov (1981–83) Yu. F. Valov (1983–95) B. I. Poletayev (1995–) V. F. Kalabin (1969–83) V. G. Volkov	This was established in 1949 at Plant No. 7 at Leningrad and subordinated to MATSKB for designing naval anti-ship artillery armaments. In 1959–60, it began work on solid propellant ballistic missiles. In 1969, it began work on space themes after being assigned the production of US-P spacecraft from KB-1. In the late 1980s, it was part of PO Arsenal, remaining so until the early 1990s.

Designer Bureau Name Established Location	Designations	Chief/General Designers	History
Yangel OKB-586 May 9, 1951 Dnepropetrovsk	<ul style="list-style-type: none"> • SKB-586 (1951-54) • OKB-586 (1954-66) • KB Yuzhnoye (1966-86) • NPO Yuzhnoye (1986-) 	V. S. Budnik (1951-54) M. K. Yangel (1954-71) V. F. Utkin (1971-90) S. N. Konyukhov (1990-)	This was established at Plant No. 586 through the transfer of personnel from NII-88 OKB-1 as Serial Design Bureau No. 586 to supervise the production of OKB-1 missiles. On April 10, 1954, another group of engineers from NII-88 was transferred to the plant, and OKB-586 was formally established.
Zaslavskiy TsNII-108 July 4, 1943	<ul style="list-style-type: none"> • VSNII Radiolokatsii (1943-46) • TsNII-108 (1946-66) • TsNIRTI (1966-) • NPO imeni P. S. Pleshakova 	M. Ye. Zaslavskiy (1960s) A. I. Berg (1946-53) N. Yemokhonov (1953-59) P. S. Pleshakov (1959-64) Yu. N. Mazhorou (1964-70s) A. Shulunov (1987-)	This is the overall systems integrator for all Soviet electronic intelligence satellite systems. It also developed electronic intelligence packages for all Soviet civil and military satellites. S. I. Baburin and V. L. Grechki were Directors of the Kaluga Branch (space) of TsNII-108, which eventually became NPO Palma.
Rocket and Ramjet Engines			
Bondaryuk OKB-670 October 1950 Moscow	<ul style="list-style-type: none"> • OKB-670 • MKB Krasnaya zvezda • NPO Krasnaya zvezda (1972-) 	M. M. Bondaryuk (1947-69) V. I. Serbin N. I. Mikhiyevich G. M. Cryaznov	This was established in 1940 as EKB-3 of NII CVF. It became part of OKB-293 before becoming part of the new NII-1 in 1944. Bondaryuk was named Chief Designer of NII-1 OKB-3 on August 30, 1947. OKB-3 separated in 1950 to become the Independent OKB-670. It worked on ramjet engines for a variety of missiles. Activities and personnel related to ramjets were transferred to TMKB Soyuz at Turayev in December 1972. The remaining part became NPO Krasnaya zvezda to work on nuclear power reactors inherited from OKB-300. Ramjet personnel were reorganized as the Plamya Branch of NII TP (later NPVO Plamya) in 1978.
Glushko OKB-456 September 29, 1946 Khimki	<ul style="list-style-type: none"> • OKB-456 (1946-67) • KB EnergoMash (1967-74) • NPO Energiya KB EnergoMash (1974-90) • Glushko NPO EnergoMash (1990-) 	V. P. Glushko (1946-89) V. P. Radovskiy (1989-91) B. I. Katargin (1991-)	This was established at Plant No. 16 at Kazan in July 1944 as OKB SD. In 1946, the group moved to Khimki near Moscow at the premises of Plant No. 456 (established on April 16, 1942) to become OKB-456. It worked on rocket engines for ICBMs and space launchers. KB EnergoMash merged with TsKBEM on May 22, 1974, to create NPO Energiya. On January 19, 1990, the two organizations separated, and KB EnergoMash became the independent NPO EnergoMash.

Designer Bureau Name Established Location	Designations	Chief/General Designers	History
Isayev OKB-2 June 23, 1944 Kaliningrad	<ul style="list-style-type: none"> • OKB-293 Dept. (1943–44) • NII-1 Dept. (1944–48) • NII-88 SKB Dept No. 9 (1948–52) • NII-88 OKB-2 (1952–59) • KB KhimMash (1967–71) • Isayev KB KhimMash (1971–) 	<p>A. M. Isayev (1947–71) V. N. Bogomolov (1971–85) N. I. Leontyev (1985–)</p>	<p>This was established as part of KB-D in OKB-293 on February 4, 1943. On May 29, 1944, OKB-293 merged with NII RA to form the new NII-1. On June 23, 1944, Isayev was named chief of the department at NII-1. He was then named Chief Designer on August 30, 1947. The department was transferred to NII-88 on July 1, 1948, as the new SKB Department No. 9, which in March 1952 became OKB-2 of NII-88. OKB-2 and NII-88's OKB-3 combined in December 1958. On January 16, 1959, OKB-2 became independent. It worked on engines for SAMs, submarine-launched ballistic missiles, spacecraft, and space launchers (KhimMash means Chemical Machine Building).</p>
Izotov OKB-117 August 1935 Leningrad	<ul style="list-style-type: none"> • OKB-117 • Leningrad OKB Klimov (1963–75) • Leningrad NPO Klimov (1975–92) • AOOT Klimov (1992–) 	<p>V. Ya. Klimov (1946–62) S. P. Izotov (1960–83) V. C. Stepanov (1983–88) A. A. Sarkisov</p>	<p>This was established in 1935 at Plant No. 26 at Rybinsk which later evacuated to Ufye. There in 1941 it merged with the Krasnyy Oktyabr Plant (established originally as Russkiy Reno Plant in 1914 in St Petersburg) which also evacuated to Ufye in August 1941. In 1946 Klimov became head of the Leningrad OKB and simultaneously headed OKB 45 in Moscow in 1947–56. This organization worked on engines for the upper stage of Chelomey's ICBMs and the LK 700 lunar lander.</p>
Kartukov Plant No. 81 1946 Moscow	<ul style="list-style-type: none"> • Plant No. 81 KB-2 • KB Iskra • MKB Iskra 	<p>I. I. Kartukov (1946–60s) B. A. Raysberg Yu. K. Kulikov (1980s)</p>	<p>This was established at Plant No. 81, which later became the Iskra Plant. It worked on solid-propellant accelerators for SAMs, naval missiles, and space launcher escape systems.</p>
Kosberg OKB-154 October 13, 1941 Voronezh	<ul style="list-style-type: none"> • OKB-296 (1941–46) • OKB-154 (1946–57) • GSOKB-154 (1957–66) • KB KhimAvtomatiki (1966–) 	<p>S. A. Kosberg (1941–65) A. D. Konopátov (1965–93) V. S. Rachuk (1993–)</p>	<p>This was established as OKB-296 at Berdsk as a result of the evacuation of Plant No. 296 from Kharkov and part of OKB of Plant No. 33 from Moscow. In late 1945, it was transferred to Voronezh to Plant No. 265, becoming OKB-154 on May 30, 1946. On August 20, 1957, it was reorganized into the State Union Experimental Design Bureau No. 154 (CSOKB-154). It worked on engines for SAMs, SLBMs, ICBMs, and space launch vehicles (KhimAvtomatiki means Chemical Automation).</p>

CHALLENGE TO APOLLO

Designer Bureau Name Established Location	Designations	Chief/General Designers	History
Kuznetsov OKB-276 April 17, 1946 Kuybyshev	<ul style="list-style-type: none"> • OKB-276 (1953–67) • KB Trud (1967–81) • Kuybyshev NPO Trud (1981–91) • Samara GNPP Trud (1991–94) • Samara NTK NK Dvigatel (1994–96) • AOOT Samara NTK Kuznetsov (1996–) 	N. D. Kuznetsov (1949–94) Ye. A. Critsenko (1994–)	This was established at Plant No. 2 at Kuybyshev in 1946. Plant No. 2 was reformed into Plant No. 276 in June 1953. It became NPO in 1982 after merging with the Kuybyshev Motor Plant. Its main work was jet engines for aircraft. It moved into rocket engines for ICBMs and space launch vehicles in the late 1950s.
Lyulka OKB-165 March 30, 1946 Moscow	<ul style="list-style-type: none"> • OKB-165 (1946–67) • KB Saturn (1967–82) • NPO Saturn (1982–84) • Lyulka NPO Saturn • Lyulka OAO Saturn 	A. M. Lyulka (1946–84) V. M. Chepkin (1984–)	This was originally a department at NII-1 and detached in 1946 to Plant No. 165 (later MZ Saturn) in Moscow to form the Independent OKB-165. In 1982, MKB Granit and MZ Saturn combined to create NPO Saturn. MKB Granit had been established in 1945 as OKB-45 at Plant No. 45 in Moscow. In 1963, OKB 45 was renamed OKB-45-165 and then MKB Granit in 1966. OKB 165's main work was jet engines but it developed the liquid hydrogen engine for the lunar program in the 1960s.
Stechkin OKB Fakel 1959 Kaliningrad	<ul style="list-style-type: none"> • OKB Fakel (1971–) 	B. S. Stechkin (1955–69) A. S. Moyegulov (1980s) M. I. Shalamov V. V. Suslennikov (1980s) A. S. Bober (1989–)	This was established in 1959 as a laboratory under the USSR Academy of Sciences. It was reorganized in 1971 as OKB Fakel. It worked on attitude control thrusters for spacecraft. It may have been related to NII-88's OKB-3 headed in 1952–58 by D. D. Sevruk.
Stepanov TMKB Soyuz August 1, 1964 Turayevo	<ul style="list-style-type: none"> • TMKB Soyuz • NPO Soyuz 	V. G. Stepanov (1964–83) D. D. Gilevich (1983–91) G. V. Komissarov (1991–)	This was established in 1964 as a branch of OKB-300 for the development of attitude control engines for spacecraft. TMKB Soyuz inherited all work on ramjet engines from OKB-670 in December 1972. Eventually, the space-related activities of TMKB Soyuz moved to a location in Moscow while ramjet research continued at Turayevo until 1978.
Tumanskiy OKB-300 February 18, 1943 Tushino	<ul style="list-style-type: none"> • OKB-300 (1943–66) • MMZ Soyuz (1966–81) • MNPO Soyuz • Tushino MKB Soyuz 	A. A. Mikulin (1943–55) S. K. Tumanskiy (1955–73) O. N. Favorskiy (1973–87) V. K. Kobchenko (1987–)	This organization's original profile was jet engines for aircraft. In the 1960s, it developed low thrust rocket engines for robotic spacecraft and small nuclear reactor power sources. Its former profile moved to TMKB Soyuz while the latter moved to MKB Krasnaya zvezda, both in 1972.

Designer Bureau Name Established Location	Designations	Chief/General Designers	History
launch Complexes			
Barmin GSKB SpetsMash June 30, 1941 Moscow	<ul style="list-style-type: none"> • Kompressor Plant SKB (1941–46) • GSKB SpetsMash (1946–67) KB OM (1967–93) • Barmin KB Obshchego mashinostroyeniya (1993–) 	V. P. Barmin (1941–93) I. V. Barmin (1993–)	This was established at the Kompressor Plant in Moscow to produce Katyusha launchers during World War II. In May 1946, it began work on launch complexes for ballistic missiles and SAMs. It later did the same for space launch vehicles. It also worked on robotic soil scoopers and long-term lunar bases (SpetsMash means Special Machine Building).
Solovyev TsKB TransMash August 10, 1948 Moscow	<ul style="list-style-type: none"> • GSKB (1948–67) • KB TransMash (1967–) 	G. A. Yakovlevtch (1948–51) V. P. Petrov (1951–63) V. N. Solovyev (1963–91) G. P. Biryukov (1992–)	This organization originally produced ground equipment for missiles. In 1963, it became the leading developer of launch complexes for ICBMs and space launch vehicles (TransMash means Transport Machine Building).
Communications, Control, and Guidance Systems			
Abramov OKB-12	<ul style="list-style-type: none"> • NISO • OKB-12 	G. A. Levin (1940s) N. I. Petrov (1940s) A. S. Abramov (1960s)	This organization developed propellant loading control systems for the NI, as well as nuclear reactor control systems.
Bogomolov OKB MEI 1947 Moscow	<ul style="list-style-type: none"> • MEI ONIP (1947–58) • OKB Moskovskogo energeticheskogo instituta (1958–) 	V. A. Kotelnikov (1947–54) A. F. Bogomolov (1954–88)	This was established as the Experimental Scientific-Research Profile (ONIP) sector of MEI (Moscow Power Institute) in 1947. In September 1958, this sector became OKB. It developed telemetry systems for ICBMs, space launchers, and spacecraft.
Bykov NII-695 1927 Moscow	<ul style="list-style-type: none"> • NII-695 (1950–65) • MNII RadioSvyazi • AOOT MNII RadioSvyazi 	B. M. Konoplev (1955–59) Yu. S. Bykov (1959–70) A. P. Bilenko I. D. Bogachev N. N. Nesvit N. A. Pochtar N. Kh. Golshteyn M. R. Kaplanov	This entity became involved in space and missile programs in 1957. It developed communications systems for piloted and automated spacecraft (RadioSvyazi means Radio Communications).

Designer Bureau Name Established Location	Designations	Chief/General Designers	History
NII-695 cont.		M. S. Nemirovskiy (1960s) V. I. Mescheryakov (1980s) Yu. N. Matveyev (1990s)	
Gubenko SKB-567 1950s		Ye. S. Gubenko (1950-59) A. V. Belousev (1959-??)	This was originally Department No. 12 of NII-885 but it separated from the parent organization in the 1950s. It developed telemetry systems for ICBMs and robotic spacecraft.
Kuznetsov NII-944 September 1955 Moscow	<ul style="list-style-type: none"> • NII-944 • NII PM • Kuznetsov NII Prikladnoy mekhaniki 	V. I. Kuznetsov (1955-89) I. N. Sapozhnikov (1969-)	This was established on the basis of NII-10's SKB which separated in 1955. Kuznetsov was Chief Designer of NII 10 in 1946-55. NII-944 developed gyroscopes for ICBMs, space launchers, and spacecraft (Prikladnoy mekhaniki means Applied Mechanics).
Mnatsakanyan NII-648 1953 Moscow	<ul style="list-style-type: none"> • NII-648 • NII Tochnykh priborov • NPO Tochnykh priborov 	P. Z. Stas (1953-55) N. I. Belov (1955-61) A. S. Mnatsakanyan (1961-77) O. N. Shishkin (1977-81) A. V. Churkin (1981-86) V. A. Corkovoy (1986-94) A. V. Shishanov (1994-)	This entity was established as Department No. 4 at NII-885 before becoming independent in 1953. It developed systems for robotic and piloted spacecraft. It later developed rendezvous radars for piloted spacecraft (Tochnykh priborov means Precision Instruments).
Pilyugin NII AP April 1963 Moscow	<ul style="list-style-type: none"> • NII-885 Dept. No. 31 Complex No. 1 (1948-63) • NII AP (1963-78) • NPO Avtomatiki i priborostroyeniya (1978-) • NPTs AP 	N. A. Pilyugin (1948-82) V. L. Lapygin (1982-97)	This organization was established in 1948 as Department No. 3 at NII-885. By the early 1960s, it was incorporated into Complex No. 1 which also included other departments and Pilot Plant No. 1. Complex No. 1 separated from NII 885 in April 1963 to become the Independent NII AP. It developed inertial guidance systems for missiles and spacecraft (AP stands for Automation and Instrument Building).
Ryazanskiy NII-885 February 20, 1938	<ul style="list-style-type: none"> • NII-885 (1938-46) • NII ST (1946) • NII-885 (1946-63) • NII P (1963-78) • NPO RadioPribor (1978-92) • RNII Kosmicheskogo priborostroyeniya (1992-) 	M. S. Ryazanskiy (1946-51) N. A. Pilyugin (1948-63) B. M. Konoplev (1950-55) M. S. Ryazanskiy (1955-87) N. Ye. Ivanov (1960s) M. I. Borisenko (1966-74) L. I. Gusev (1988-)	In May 1946, this entity was transferred to the Ministry of Electrical Industries (MEP) while changing its name to the Scientific Research Institute of Special Technology (NII ST). Plant No. 1 (located at the site originally built for Plant No. 192) of the Ministry of Armed Forces was handed over to NII ST on June 8, 1946. In April 1963, Complex No. 1 separated from NII-885. The remainder became the Scientific Research Institute for Instrument Building (NII P). It

Designer Bureau Name Established Location	Designations	Chief/General Designers	History
NII-885 cont.		Ye N Galin	developed radio guidance systems for missiles, launch vehicles and spacecraft as well as remote sensing, communications and navigation spacecraft payloads
Utkin NII IT July 22, 1966 Kaliningrad	<ul style="list-style-type: none"> • NII IT (1966–78) • NPO Izmeritel'noy tekhniki (1978–) 	I. I. Utkin (1953–70) O. A. Sulimov (1992–)	This was established on December 17, 1953, as Department No. 20 for measurement technology at NII-88. In October 1960, this department was reorganized into Complex No. 5 for measuring systems at NII-88. On July 22, 1966, Complex No. 5 separated from its parent institute and became independent. In July 1978, NII IT, its Ukraine Branch, and the Izmeritel' Plant combined to become NPO IT. It developed data recorders for missiles and spacecraft (Izmeritel'noy tekhniki means Measurement Technology).
<i>Biomedicine</i>			
Gazenko IMBP October 28, 1963 Moscow	<ul style="list-style-type: none"> • IMBP (1963–94) • GNTs RF-Institut mediko-biologicheskikh problem (1994–) 	A. V. Lebedinskiy (1963–65) V. V. Parin (1965–69) O. G. Gazenko (1969–88) A. I. Grigoryev (1988–)	This entity was formed by the merger of subdivisions from the Air Force Institute for Aviation and Space Medicine and then transferred to the Ministry of Health. It specialized in biomedicine research and cosmonaut training (IMBP stands for Institute for Biomedical Problems).
Samoylov SKTB Biofiz Pribor June 3, 1955 Leningrad		A. V. Samoylov (1950s) G. S. Mayorov (1992–)	This organization developed feeding systems for biological payloads in spacecraft.
Severin Plant No. 918 1952 Tomilino	<ul style="list-style-type: none"> • Plant No. 918 • KB Zvezda • AOOT NPP Zvezda 	S. M. Alekseyev (1952–73) G. I. Severin (1964–)	This entity developed ejection seats, spacesuits, and airlocks for piloted spacecraft. It also developed Soviet EVA maneuvering units.

Designer Bureau Name Established Location	Designations	Chief/General Designers	History
Volynkin GosNII AiKM 1935 Moscow	<ul style="list-style-type: none"> • NII AM (1935–60) • GosNII AiKM (1960–) 	<p>A. V. Pokrouskiy (1950s) A. G. Kuznetsov (1959–60) Yu. M. Volynkin (1960–69) N. M. Rudnry (1969–74) S. A. Gozulov (1974–84) S. A. Bugrov (1974–88) V. A. Ponomarenko (1988–92)</p>	<p>This entity was established subordinate to the Soviet Air Force. It was responsible for early cosmonaut selection and biomedicine research. Its duties for the most part were taken over by IMBP in the 1960s (AiKM stands for Aviation and Space Medicine).</p>
Voronin OKB-124 1950s Moscow	<ul style="list-style-type: none"> • OKB-124 • KB Nauka • NPO Nauka • AOOT NPO Nauka 	<p>G. I. Voronin (1939–85) I. V. Tishin (1985–) G. F. Khomutov (1990s)</p>	<p>Plant No. 124 was established during the 1930s. The design branch of the plant became OKB-124 in the 1950s. It developed life support systems for all piloted spacecraft.</p>
<i>Testing and Training</i>			
Karpov TsPK January 11, 1960 Zelenyy	<ul style="list-style-type: none"> • TsPK (1960–68) • Gagarin TsPK (1968–95) • Gagarin RGNII Tsentr podgotovki kosmonavtov (1995–) 	<p>Ye. A. Karpov (1960–63) M. I. Odintsov (1963) N. F. Kuznetsov (1963–72) G. T. Beregouov (1972–86) V. A. Shatalov (1986–91) P. I. Klimuk (1991–)</p>	<p>From 1960 to 1962 this center was subordinate to the Institute of Aviation and Space Medicine (GosNII AiKM) of the Soviet Air Force. By a decision dated April 10, 1962, this entity was directly subordinated to the Air Force General Staff. It has always been responsible for cosmonaut training.</p>
Lyzhkov NII KhSM February 24, 1960 Zagorsk	<ul style="list-style-type: none"> • NII Khimicheskikh i stroitelnykh mashin 	<p>M. V. Sukhopalko (1960–??) V. S. Lyzhkov (1960s) G. I. Matysyak (1988–)</p>	<p>This was established as the Scientific-Testing Range (NIP) for testing ground equipment. On March 6, 1966, it was reorganized as NII KhSM and served as the site for testing piloted lunar landers on a simulated lunar landscape (KhSM stands for Chemical and Building Equipment).</p>
Stroyev LII March 8, 1941 Zhukovskiy	<ul style="list-style-type: none"> • LII • Gromov LII • Gromov GNTs Letno-issledovatel'skiy institut 	<p>M. M. Gromov (1941) A. V. Chesalov (1941–42) V. S. Molokov (1942–43) A. V. Chesalov (1943–47) I. F. Petrou (1947–51) A. A. Kobzarev (1951–54)</p>	<p>The decree for establishing the Institute for Flight Research was issued on June 13, 1940. On March 8, 1941, the Peoples Commissariat of Aviation Industry adopted a decree on the creation of LII (Flight-Research Center) from a number of subdivisions of TsAGI. This entity was originally established as an aircraft and systems test center. It engaged in research on parachutes, simulators, flight training, and</p>

Designer Bureau Name Established Location	Designations	Chief/General Designers	History
LII cont.		N S <i>Stroyev</i> (1954–66) V V <i>Utkrn</i> (1966–81) A D <i>Mironov</i> (1981–85) K K. <i>Vasrichenko</i> (1985–) F. D. <i>Zolotarev</i> V M <i>Bakayev</i>	aerodynamics. It was responsible for building the Spiral spaceplane testbeds during the 1960s–80s.
Tabakov NII-229 July 7, 1948 Zagorsk	<ul style="list-style-type: none"> • NII-88 Branch No. 2 (1948–56) • NII-229 (1956–67) • NII KhimMash (1967–) 	G M <i>Tabakov</i> (1948–49) V S <i>Shachin</i> A I <i>Bykhovskiy</i> G M <i>Tabakov</i> (1957–63) V A <i>Pukhov</i> (1960s) N M <i>Samsonov</i> (1970s) Yu A <i>Korneyev</i> (1980s) A A <i>Makarov</i> (1988–)	This entity was established in 1948 as Branch No. 2 of NII-88. On August 14, 1956, it separated into an independent organization as NII-229. It served as a rocket engine test facility (KhimMash means Chemical Machine Building).
Research and Development			
GIPKh May 13, 1946 Leningrad	<ul style="list-style-type: none"> • GIPKh • NPO GIPKh 	V. S. <i>Shpak</i> (1952–77) B. V. <i>Çidasov</i> (1977–89) Ç. F. <i>Tereshchenko</i> (1989–)	This organization developed and synthesized new propellants for Soviet missile and space programs (GIPKh stands for State Institute of Applied Chemistry)
GOI December 15, 1918 Leningrad	<ul style="list-style-type: none"> • GOI • Vavilov COI • Vavilov VNTs Gosudarstvennyy opticheskiy institut (1991–) 	B A <i>Yermakou</i> L B. <i>Çlebov</i> (1990s) V I <i>Puchkov</i> (1990s) M M. <i>Miroshnikov</i> (1990s) Ç. T. <i>Petrovskiy</i> (1994–)	This entity designed optical instruments for robotic and piloted spacecraft, both civilian and military (GOI stands for State Optical Institute)
IES 1934 Kiev-5	<ul style="list-style-type: none"> • IES • Paton Institut ElektroSvarky 	B. Ye. <i>Paton</i> (1953–)	This organization developed welding technology for the missile and space programs (IES stands for Institute of Electrical Welding).
IKI July 14, 1965 Moscow	<ul style="list-style-type: none"> • Institut kosmicheskikh issledovaniy 	Ç. I <i>Petrov</i> (1965–73) R. Z. <i>Sagdeyev</i> (1973–88) A A <i>Çaleyev</i> (1988–)	This entity was established on the basis of a department at the Institute of Applied Mathematics dedicated to mission planning and data processing of scientific information. It was responsible for scientific payloads (IKI stands for Institute of Space Research).

Designer Bureau Name Established Location	Designations	Chief/General Designers	History
IPM 1953 Moscow	<ul style="list-style-type: none"> • OPM MIAN (1953-66) ■ IPM (1966-78) • Keldysh Institut prikladnoy mekhaniki (1978-) 	<p><i>M V Keldysh (1953-78)</i> <i>A N Tikhonov</i> <i>S P Kurdyumov (1990s)</i></p>	<p>This entity was established as the Department of Applied Mathematics Of the Mathematics Institute Named After V A Steklov of the USSR Academy of Sciences (OPM MIAN). In 1966 it became independent. It was responsible for mission modeling and ballistics computations (IPM means Institute of Applied Mathematics)</p>
LOMO February 4, 1914 Leningrad	<ul style="list-style-type: none"> • RAOOMP (1914-) • LOMO (until 1993) • AOOT Leningradsoye optiko-mekhanicheskoye obedineniye (1993-) 	<p><i>M P Panfilov (1970-94)</i> I I Klebanov (1994-97) <i>A S Kobitskiy (1997-)</i></p>	<p>This organization developed optical systems for robotic and piloted spacecraft (LOMO stands for Leningrad Optical Mechanical Association)</p>
NII-1 September 21 1933 Moscow	<ul style="list-style-type: none"> • RNII (1933-36) • NII-3 (1936-42) • GIRT (1942-44) • NII RA (1944) ■ NII-1 (1944-48) • TsiAM Branch No. 1 (1948-52) • NII-1 (1952-65) • NII Teplovyy protsessy (1965-95) • Keldysh issledovatel'skiy tsentr (1995-) 	<p><i>I T Kleymenov (1933-37)</i> <i>B N Slonimer (1937-39)</i> <i>A G Kostikov (1939-44)</i> <i>V I Polikovskiy (1944)</i> <i>P I Fedorov (1944-45)</i> <i>Ya L Bibikov (1945-46)</i> <i>M V Keldysh (1946-55)</i> <i>V Ya Likhushin (1955-88)</i> <i>A S Koroteyev (1988-)</i></p>	<p>This entity was established in 1933 with the merger of GIRD and CDL. On July 15, 1942, it was renamed the State Institute of Reactive Technology (GIRT) with subordinates Plant No. 55 and Plant No. 462. On February 18, 1944, it was renamed NII RA, and on May 29, 1944, it absorbed OKB-293 and became NII-1. In June 1946, OKB-293 separated. Between 1948 and March 10, 1952, NII-1 was a branch of TsiAM. It was responsible for research on high speed flight, advanced rocket engines, nuclear rocket engines, and aerodynamic modeling. A branch (established in 1958) of NII-1 separated in 1981 to become NII Mashinostroyeniya, which developed micro rocket engines for spacecraft (Teplovyy protsessy means Thermal Processes)</p>
NII-4 June 21, 1946 Bolshevo	<ul style="list-style-type: none"> • NII-4 (1946-72) • TsNII-4 (1972-) 	<p><i>A I Nesterenko (1946-50)</i> <i>G A Tyul'n (1950-51)</i> <i>P P Chechulin (1951-55)</i> <i>A I Sokolov (1955-70)</i> <i>Ye B Volkov (1970-82)</i> <i>L I Volkov (1982-93)</i> <i>V Z Dvorkin (1993-)</i></p>	<p>This was established as a result of a Council of Ministers decree on May 13, 1946. The Ministry of Armed Forces order for formation was dated May 24, 1946. The entity was responsible for research on military applications of ballistic missiles and spacecraft. On April 3, 1972, the space branch of NII-4 (established on March 11, 1968) separated to become the independent TsNII-50.</p>
NII-88 May 16, 1946 Kaliningrad	<ul style="list-style-type: none"> • NII-88 (1946-67) • TsNIIMash (1967-) 	<p><i>L R Gonor (1946-50)</i> <i>K N Rudnev (1950-52)</i> <i>M K Yangel (1952-53)</i></p>	<p>This entity was established on the premises of Plant No. 88 at Kaliningrad. The plant was established in 1866 as Plant No. 8 at St. Petersburg. The organizational structure of NII-88 was fortified by a</p>

Designer Bureau Name Established Location	Designations	Chief/General Designers	History
NII-88 cont.		A S <i>Spiridinov</i> (1953–59) G A <i>Tyulin</i> (1959–61) Yu A <i>Mozzhorin</i> (1961–90) V F <i>Utkin</i> (1990–2000)	decision date August 26 1946 It was responsible for basic research and development on various space profiles as well as for the long range planning of the Soviet space program (TsNIIMash stands for Central Scientific Research Institute of Machine Building)
NITI-40 May 28, 1938 Moscow	<ul style="list-style-type: none"> • TsSKB-40 (1938–40) • GSPI-40 (1940–46) • NITI-40 (1946–67) • NII TekhnoMash (1967–90) • NPO TekhnoMash (1990–92) • CP NPO TekhnoMash (1992–) 	A V <i>Kolupayev</i> (1960s 1980s) O Ye <i>Ostrousky</i> (1960s) V A <i>Isachenko</i> (1990s) V V <i>Bulavkin</i> (1991–)	GSPI 40 was established in 1940 on the basis of TsSKB-40 GSPI 3, and part of CSPI-7 in NKOP In August 1946 it was renamed NITI-40 It was responsible for research and development on manufacturing processes and tool manufacture for the Soviet missile and space industry
TsAGI December 1, 1918 Zhukovsk-y	<ul style="list-style-type: none"> • TsAGI • Zhukovsk-y TsAGI • Zhukovsk-y GNTs RF-Tsentralnyy aerogidrodinamicheskiy institut 	5 N <i>Shtshkn</i> (1941–50) A I <i>Makareusky</i> (1950–60) V M <i>Myasishchev</i> (1960–67) G P <i>Suishchev</i> (1967–89) G I <i>Zagaynov</i> (1989–93) V Ya <i>Neyland</i> (1993–) V G <i>Dmitriyev</i> (1990s)	This was responsible for basic and applied research on high-speed flight, including the spaceplane and lifting body programs (TsAGI stands for Central Aerohydrodynamics Institute)
TsIAM December 3, 1930 Moscow	<ul style="list-style-type: none"> • IAM (1930–32) • TsIAM (1932–33) • Baranov Tsentralnoye institut aviatsionnogo motorostroyeniya (1933–) 	G P <i>Suishchev</i> (1954–67) 5 M <i>Shiyakhthenko</i> (1967–82) D A <i>Ogorodntkou</i> (1982–)	This entity was responsible for research and testing of air breathing propulsion systems for spaceplanes and lifting bodies (TsIAM stands for Central Institute of Aviation Motor Building)
TsNII-50 April 3, 1972 Moscow	<ul style="list-style-type: none"> • TsNII-50 (1972–95) • Tikhonravov TsNII-50 (1995–) 	G P <i>Melntkou</i> (1972–83) I V <i>Meshcheryakou</i> (1983–88) E V <i>Alekseyev</i> (1988–93) V A <i>Menshtkou</i> (1993–)	This entity was established the space branch of NII-4 on March 11 1968 before separating from the parent institute on April 3 1972 Starting in 1982 TsNII 50 was subordinated to UNKS It was also known as military unit no 73790 It became a branch of GKNPTs Khronichev in November 1997 It was responsible for planning military applications of spacecraft

Designer Bureau Name Established Location	Designations	Chief/General Designers	History
VIAM June 28, 1932 Moscow	<ul style="list-style-type: none"> • VIAM (1932–92) • Vserossiyskiy NII aviatsionnykh materialov (1992–) 	<p>R. T. Tumanov (1938–50) V. V. Boytsou (1950–63) R. T. Tumanov (1963–76) P. Ye. Shalin (1977–)</p>	<p>This organization was formed on the basis of the aviation material testing department at TsAGI. It was responsible for research and development, testing, and certification of all metallic and nonmetallic materials used on spacecraft, and hypersonic vehicles (VIAM stands for All-Russian Institute of Aviation Materials).</p>
<i>Other Systems</i>			
Darevskiy SOKB LII August 21, 1967 Zhukovskiy-2	<ul style="list-style-type: none"> • SOKB LII (1967–83) • NII Aviatsionnogo oborudovaniya (1983–97) • SOKB KT NII AO (1997–) 	<p>S. G. Darevskiy (1965–75) S. A. Borodin (1975–)</p>	<p>This was established as a subdivision of LII. It separated from LII in 1971. In 1982, it merged with another branch at LII to become NII AO. It developed simulators, cockpit consoles, and avionics for piloted spacecraft (AO stands for Aviation Equipment).</p>
Goltsman OKB-686 Moscow	<ul style="list-style-type: none"> • OKB-686 • GOKB Prozhektor • PO Prozhektor 	<p>A. M. Goltsman V. A. Okunev</p>	<p>This entity developed power source components for missiles and spacecraft.</p>
Kemurdzhian VNII-100 1947 Leningrad	<ul style="list-style-type: none"> • VNII-100 • VNII TransMash 	<p>A. A. Kemurdzhian (1960s) E. K. Potemkin (1990s)</p>	<p>This organization developed mobile robots for robotic and piloted spacecraft, including Lunokhod (TransMash means Transport Machine Building).</p>
Khrustalev TsKB-589 Moscow	<ul style="list-style-type: none"> • TsKB-589 • TsKB Geofizika • NPO Geofizika 	<p>V. A. Khrustalev (1950s–60s) N. G. Vinogradov (1960s) V. S. Kuzmin</p>	<p>This plant was established in 1852. In 1957–58, it became involved in the space program. It developed attitude control sensors for robotic and spacecraft.</p>
Lidorenko VNII IT Moscow	<ul style="list-style-type: none"> • VNII IT • GNPP Kvant (1987–) 	<p>N. S. Lidorenko Yu. V. Skokov A. B. Slutskiy</p>	<p>This entity developed battery and solar power sources for missiles and spacecraft. In 1987, it merged with the Foton Experimental Plant to become GNPP Kvant (IT stands for Current Sources).</p>
Rosselevich NII-380 1946 Leningrad	<ul style="list-style-type: none"> • NII-380 • VNII Televideniya • NII Televideniya 	<p>I. A. Rosselevich M. A. Grudzhinskiy (1983–)</p>	<p>This organization developed TV systems for robotic and piloted spacecraft.</p>

Designer Bureau Name Established Location	Designations	Chief/General Designers	History
Tkachev NIEI PDS 1946 Moscow	<ul style="list-style-type: none"> • NIEI PDS (1946–66) • NII ALI (1966–80s) • NII Parashutostroyeniya 	F. D. Tkachev (until 1968) N. A. Lobanov (1968–77) O. V. Rysev (1978–)	This entity developed parachute systems for robotic and piloted spacecraft.
<i>Offensive Space Systems</i>			
Kisunko OKB-30 1962	<ul style="list-style-type: none"> • KB-1 SKB-30 (1955–61) • OKB-30 (1961–70) • TsNPO Vympel (1970–92) • MAK Vympel (1992–) 	C. V. Kisunko (1955–75) A. G. Basistov (1960s-90s) V. G. Repin (1970–) A. A. Kuzmin (1990s) A. V. Menshikov (1990s) M. A. Arkharov (1990s)	This entity was established as SKB-30, a subdivision of KB-1, in April 1955 to focus on anti-ballistic missiles. It separated from KB-1 in August 1961 to become the Independent OKB-30. In 1970, it combined with several other organizations (Radiotechnical Institute, NII DAR, KB RadioPribor, and Dnepropetrovsk Radio Plant) to form TsNPO Vympel. It worked on anti-ballistic missile systems and the Soviet "Star Wars" program.
Nudelman OKB-16	<ul style="list-style-type: none"> • OKB-16 • KB TochMash 	A. E. Nudelman (1943–87)	This entity was established to focus on anti-aircraft guns. In the late 1950s it shifted to anti-tank missiles and later to lasers. It designed space-based cannons for Chelomey and Kozlov (TochMash means Precision Machine Building).
Ustinov TsKB Luch 1969 Moscow	<ul style="list-style-type: none"> • TsKB Luch • TsKB Astrofizika • NPO Astrofizika 	N. D. Ustinov (1969–88) B. Chemodanov (1988–92) N. D. Belkin (1992–) V. Orlov N. Sheburkin	This entity was established to work on ground and space-based lasers. NPO Astrofizika eventually included KB Rubin, KB Ametist, KB Granat, and Nov Electromechanical Plant. This organization was also linked to KB Raduga, which focused on the creation of laser weaponry. Orlov and Sheburkin were at KB Cranat, which separated in April 1992, followed by Nov Plant and KB Ametist.

Note. Design entities often had a Director in addition to a Chief Designer or General Designer. For the sake of brevity, only the Chief/General Designers are listed. In the cases of some institutes, the Directors are listed (in italic type).

Selected Sources

1. *Raketno-kosmicheskaya otrasl' rossii, 1996-97: katalog predpriyatiy, uchrezhdeniy i organizatsii* (Moscow: RKA, 1996).
2. Stephane Chenard, *Euroconsult's Space Directory of Russia* (Paris: Euroconsult, 1993).
3. V. V. Favorskiy and I. V. Meshcheryakov, eds., *Voyenno-kosmicheskiiy trud: kniga I: kosmonavtika vooruzhennyye sily* (Moscow: Sankt-Peterburgskoy tipografii no. 1 VO Nauka, 1997).
4. Grigoriy Kisunko, *Sekretnaya zona* (Moscow: Sovremennik, 1996).
5. Yu. A. Mozzhorn, et al., eds., *Nachalo kosmicheskoy ery: vospominaniya veteranou raketno-kosmicheskoy tekhniki i kosmonavtiki: vypusk utoroy* (Moscow: RNITSKD, 1994).
6. Yu. P. Semenov, ed., *Raketno-Kosmicheskaya Korporatsiya "Energiya" imeni S. P. Koroleva* (Korolev: RKK Energiya, named after S. P. Korolev, 1996).
7. U.S.-Russia Business Development Committee Defense Conversion Subcommittee, *Russian Defense Business Directory* (Washington, DC: U.S. Department of Commerce, 1993).
8. Various correspondences with Mark S. Hilmyer.

TABLE V

Table V
Space Launch Vehicle Designations

U.S. Dept. of Defense	Sheldon	Soviet Public	Missile Derived From	Production Index	First Orbital Attempt	Payload
SL-1	A	Sputnik	R-7	8K71PS	Oct. 4, 1957	Sputnik
SL-2	A	Sputnik	R-7	8A91	April 27, 1958	<i>Sputnik</i>
SL-3	A-1	Luna	R-7	8K72	Sept. 23, 1958	Luna
SL-3	A-1	Vostok	R-7	8K72K	Dec. 22, 1960	<i>Korabl-Sputnik</i>
SL-3	A-1	Vostok	R-7A	8A92	July 28, 1962	Kosmos-7
SL-3	A-1	Vostok-M	R-7A	8A92M	March 17, 1966	Kosmos-112
SL-4	A-2	Voskhod	R-7A	11A57	Nov. 16, 1963	Kosmos-22
SL-4	A-2	Soyuz	R-7A	11A511	Nov. 28, 1966	Kosmos-133
SL-4	A-2	Soyuz-L	R-7A	11A511L	Nov. 24, 1970	Kosmos-379
SL-4	A-2	Soyuz-M	R-7A	11A511M	Dec. 27, 1971	Kosmos-470
SL-4	A-2	Soyuz-U	R-7A	11A511U	May 18, 1973	Kosmos-559
SL-4	A-2	Soyuz-U2	R-7A	11A511U2	Dec. 28, 1982	Kosmos-1426
SL-5	A-1m		R-7A	11A510	Dec. 22, 1965	Kosmos-102
SL-6	A-2e	Molniya	R-7A	8K78	Oct. 10, 1960	Mars
SL-6	A-2e	Molniya-M	R-7A	8K78M	Feb. 19, 1964	Venera
SL-7	B-1	Kosmos-2	R-12	63S1	Oct. 27, 1961	Kosmos
SL-7	B-1	Kosmos-2	R-12	63SIM/11K63	Oct. 19, 1965	Kosmos-93
SL-8	C-1	Kosmos-1	R-14	65S3	Aug. 18, 1964	K-38139140
SL-8	C-1	Kosmos-3	R-14	11K65	Nov. 16, 1966	Kosmos
SL-8	C-1	Kosmos-3M	R-14	11K65M	May 15, 1967	Kosmos-158
SL-8	C-1	-	R-14	K65MR	June 3, 1982	Kosmos-1374
SL-9	D	Proton	UR-500	8K82	July 16, 1965	Proton-1
SL-10	A-m	-	R-7A	11A59	Nov. 1, 1963	Polet-1
SL-11	F-1r	-	R-36-O	8K69	Dec. 16, 1965	<i>OQCh</i>
SL-11	F-1m	Tsiklon-2A	R-36	11K67	Oct. 27, 1967	Kosmos-185
SL-11	F-1m	Tsiklon-2	R-36	11K69	Aug. 6, 1969	Kosmos-291
SL-12	D-1e	Proton-K	UR-500K	8K82K	March 10, 1967	Kosmos-146
SL-13	D-1	Proton-K	UR-500K	8K82K	Nov. 16, 1968	Proton-4
SL-14	F-2	Tsiklon-3	R-36	11K68	June 24, 1977	Kosmos-921
SL-15	G-1e	NI	-	11A52	Feb. 21, 1969	L3S
SL-16	J-1	Zenit-2	-	11K77	June 21, 1985	
SL-17	K-1	Energiya	-	14A02	May 15, 1987	Polyus
SL-17	K-1	Energiya	-	11K25	Nov. 15, 1988	Buran

U.S. Dept. of Defense	Sheldon	Soviet Public	Missile Derived From	Production Index	First Orbital Attempt	Payload
SL-18	L-1	Start-1	RT-2PM	-	March 25, 1993	Start-1-1
SL-19	-	Rokot	UR-100N	-	Dec. 26, 1994	RS-15
-	-	Start	RT-2PM	-	March 28, 1995	Gurwin-1, UNAMSAT EKA
		Start-12	RT-2PM	-	March 4, 1997	Zeya
		Shtil-1N	R-29RM	-	July 7, 1998	Tubsat-N, Tubsat-N1

Abandoned Projects

Name	Production Index	Dates	Design Bureau	Description
A-300		Late 1950s	Chelomey	For Raketoplan
UR-200K	8K81K	1960-64	Chelomey	For IS and US
UR-200A	8K83	1960-64	Chelomey	Orbital bomb
UR-700		1964-69	Chelomey	Moon rocket
UR-700M	-	1969-71	Chelomey	Mars rocket
UR-530	11K99	Late 1970s	Chelomey	For heavy Alrnaz
RLA-150	-	1974-76	Glushko	Heavy lift
Vulkan	-	1974-76	Glushko	Heavy lift
-	8A93	1957-60	Korolev	For recon satellite
-	8K73	1958-59	Korolev	Lunar rocket
YaKhR-2		Early 1960s	Korolev	Nuclear rocket
-		Early 1960s	Korolev	Nuclear rocket
KhR-3		Early 1960s	Korolev	Heavy-lift rocket
MR	8K711	1960-62	Korolev	For Sever
	11A55	1962-63	Korolev	For Soyuz-A
-	11A56	1962-63	Korolev	For Soyuz-B/V
N1	11A51	1960-62	Korolev	Early N1
N2	11A52	1960-62	Korolev	Early N1
N11	11A53	1962-65	Korolev	N1 variant
N111	11A52	1962-65	Korolev	N1 variant
GR-1	8K513	1962-65	Korolev	GR-1 variant
	11A514	1964-65	Kozlov	For Soyuz-R
M-1	-	1959-60	Myasishchev	
Tsiklon-1	64S2	Early 1960s	Yangel	Based on R-16
SK-100		Early 1960s	Yangel	Heavy rocket
R-56		1962-64	Yangel	Moon rocket

CHALLENGE TO APOLLO

TABLE V

Notes

1. The "SL" column refers to U.S. Department of Defense designations for "Satellite Launcher." The system is roughly chronological from SL-8 to SL-17 in order of introduction of the launcher. The first mention of the "SL" system in a declassified CIA document dates from March 2, 1967. This was in U.S. Central Intelligence Agency, "National Intelligence Estimate 11-1-67: The Soviet Space Program," Washington, DC, March 2, 1967, as declassified December 11, 1992, by the CIA Historical Review Program.
2. The one major discrepancy in the "SL" system is with SL-5 and SL-10. For almost three decades, Western analysts have equated SL-5 with the Polet launches in 1963-64 and SL-10 with two isolated Kosmos launches in 1965-66. When CIA NIE 11-1-67 was declassified in December 1992 (see first note above), it turned out that in truth it was exactly the opposite—that is, SL-5 launched Kosmos-102 and Kosmos-105 in 1965-66, while SL-10 launched the two Polet satellites in 1963-64.
3. The "Sheldon" column denotes the system devised by Charles S. Sheldon II, who was the Chief of the Science Policy Research Division at the Library of Congress. It was first described in Charles S. Sheldon II, "The Soviet Space Program: A Growing Enterprise," *TRW Space Log* 8(4) (Winter 1968-69): 3-23.
4. If the payload is listed in italics, it indicates that the payload failed to attain Earth orbit.

Selected Sources

1. B. Ye. Chertok. *Rakety i lyudi: goryachiye dni kholodnoy uoyny* (Moscow: Mashinostroyeniye, 1997).
2. S. N. Konyukhov and V. A. Pashchenko. "History of Space Launch Vehicles Development." paper presented at the 46th Congress of the International Astronautical Federation, IAA-95-IAA 2.2.09. Oslo, Norway, October 2-6, 1995.
3. V. Pappo-Korystin, V. Platonov and V. Pashchenko, *Dneprovskiy raketno-kosmicheskii tsentr* (Dnepropetrovsk: PO YuMZ/KBYu, 1994).
4. Yu. P. Semenov, ed., *Raketno-Kosmicheskaya Korporatsiya "Energiya" imeni S. P. Koroleva* (Korolev: RKK Energiya, named after S. P. Korolev, 1996).
5. U.S. Central Intelligence Agency, "National Intelligence Estimate 11-1-71: The Soviet Space Program." Washington, DC, July 1, 1971, as declassified in 1997 by the CIA Historical Review Program.

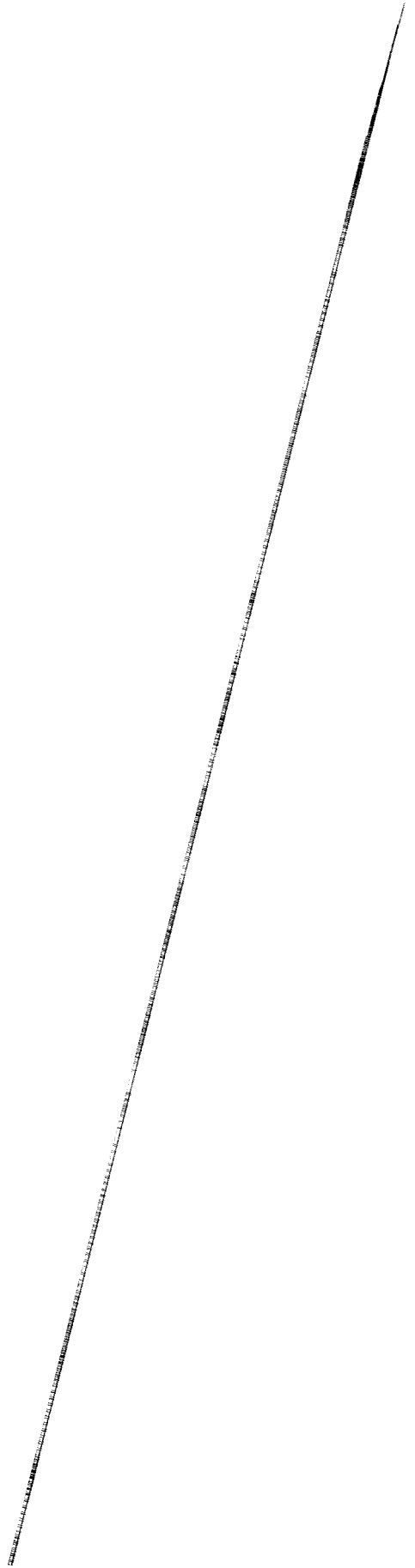

Table VI
Details of Launch Vehicles Used in the Soviet Piloted Space Program, 1957-74

Launcher	Served	OKB	Length (meters)	Base Diameter (meters)	Total Launch Thrust (tons)	Total Launch Mass (tons)	Capacity* (tons)	Stages and Engines	Engine Contractors
8K71PS Sputnik	1957	Korolev	29.17	10.3	398	267.3	c. 2 to LEO	1. 4 x 8D74PS 2. 1 x 8D75PS	1. Glushko 2. Glushko
8A91 Sputnik	1958	Korolev	30.21	10.3	388	269.4	c. 2 to LEO	1. 4 x 8D76 2. 1 x 8D77	1. Glushko 2. Glushko
8K72 Luna	1958-60	Korolev	33.5	10.3	407.5	279.1	c. 5 to LEO	1. 4 x 8D74 2. 1 x 8D75 3. 1 x 8D714	1. Glushko 2. Glushko 3. Kosberg
8K72 Vostok	1960-62	Korolev	38.36	10.3	407.5	283.5	4.55 to LEO	1. 4 x 8D74 2. 1 x 8D75 3. 1 x 8D714	1. Glushko 2. Glushko 3. Kosberg
8K72K Vostok	1960-63	Korolev	38.36	10.3	409.8	287	4.73 to LEO	1. 4 x 8D74 2. 1 x 8D75 3. 1 x 8D719	1. Glushko 2. Glushko 3. Kosberg
11A57 Voskhod	1963-76	Korolev	43.5- 45.22	10.303	413.3	—	c. 7.5 to LEO	1. 4 x RD-107 2. 1 x RD-108 3. 1 x RD-0108	1. Glushko 2. Glushko 3. Kosberg
8K82 Proton	1965-66	Chelomey	43.5	7.4	894	550	12.2 to LEO	1. 6 x RD-253 2. 3 x RD-0208 1 x RD-0209	1. Glushko 2. Kosberg
11A511 soyuz	1966-75	Kozlov	49.913	10.303	413.3	310	c. 7.5 to LEO	1. 4 x RD-107 2. 1 x RD-108 3. 1 x RD-0110	1. Glushko 2. Glushko 3. Kosberg

TABLE VI

CHALLENGE TO APOLLO

Launcher	Served	OKB	Length (meters)	Base Diameter (meters)	Total Launch Thrust (tons)	Total Launch Mass (tons)	Capacity' (tons)	Stages and Engines	Engine Contractors
8K82K Proton-K	1967-	Chelomey	57.1- 61.1	7.4	894	690	4.8 to GTO. 5.7 to Moon	1. 6 x RD-253 2. 3 x RD-0210 1 x RD-0211 3. 1 x RD-0212 4. 1 x 11D58	1. Clushko 2. Kosberg 3. Kosberg 4. Korolev
8K82K Proton-K	1968-	Chelomey	57.8	7.4	894		20-21 to LEO	1. 6 x RD-253 2. 3 x RD-0210 1 x RD-0211 3. 1 x RD-0212	1. Clushko 2. Kosberg 3. Kosberg
11A52 NI	1969-72	Korolev	105.286	16.875	4,620	2,750	91.5 to 220-km orbit	1. 30 x NK-15 2. 8 x NK-15V 3. 4 x NK-21 4. 1 x NK-19 5. 1 x 11D58	1. Kuznetsov 2. Kuznetsov 3. Kuznetsov 3. Kuznetsov 3. Korolev
11A511L Soyuz-L	1970-71	Kozlov	45	10.3	413.3	310	c. 7.5 to LEO	1. 4 x RD-107 2. 1 x RD-108 3. 1 x RD-0110	1. Clushko 2. Clushko 3. Kosberg
11A511U Soyuz-U	1973-	Kozlov	49.3	10.303	413.3	310	6.8 to 220-km orbit	1. 4 x RD-107 2. 1 x RD-108 3. 1 x RD-0110	1. Clushko 2. Clushko 3. Kosberg

* LEO = low-Earth orbit; GTO = geostationary transfer orbit; km = kilometer

Selected Sources

1. Igor Afanasyev. "N-1: Absolutely Secret" (English title). *Krylia rodiny* no. 9 (September 1993). 13-16.
2. M. V. Keldysh, ed.. *Tuorcheskoe nasledie Akademika Sergeya Pavlovicha Koroleva. izbrannie trudi i dokumenty* (Moscow: Nauka. 1980).
3. V. P. Mishin, "Why Didn't We Fly to the Moon?" (English title). *Znaniye: tekhnika. seriya kosmonavtika, astronomiya* no. 12 (December 1990): 3-43.
4. S. Sergeev, "Tsiklon." *Aviatsiya i kosmonavtika* no. 2 (March-April 1994): 38-41.
5. S. P. Urnanskiy. "Russian Space Launch Vehicles" (English title). *Zemlya i usemennaya* no. 2 (March-April 1994): 97-105.
6. T. Varfolomeyev. "Soviet Rocketry that Conquered Space: Part 1: From First ICBM to Sputnik Launcher," *Spaceflight* 37 (1995): 260-63.
7. T. Varfolomeyev, "Soviet Rocketry that Conquered Space: Part 2: Space Rockets for Lunar Probes." *Spaceflight* 38 (1996). 49-52.
8. T. Varfolomeyev. "Soviet Rocketry that Conquered Space: Part 3: Lunar Launchings for Impact and Photography." *Spaceflight* 38 (1996): 206-08.
9. Phillip Clark, ed.. *Jane's Space Directory: 1997-98* (Coulsdon. UK: Jane's Information Group Ltd.. 1997).

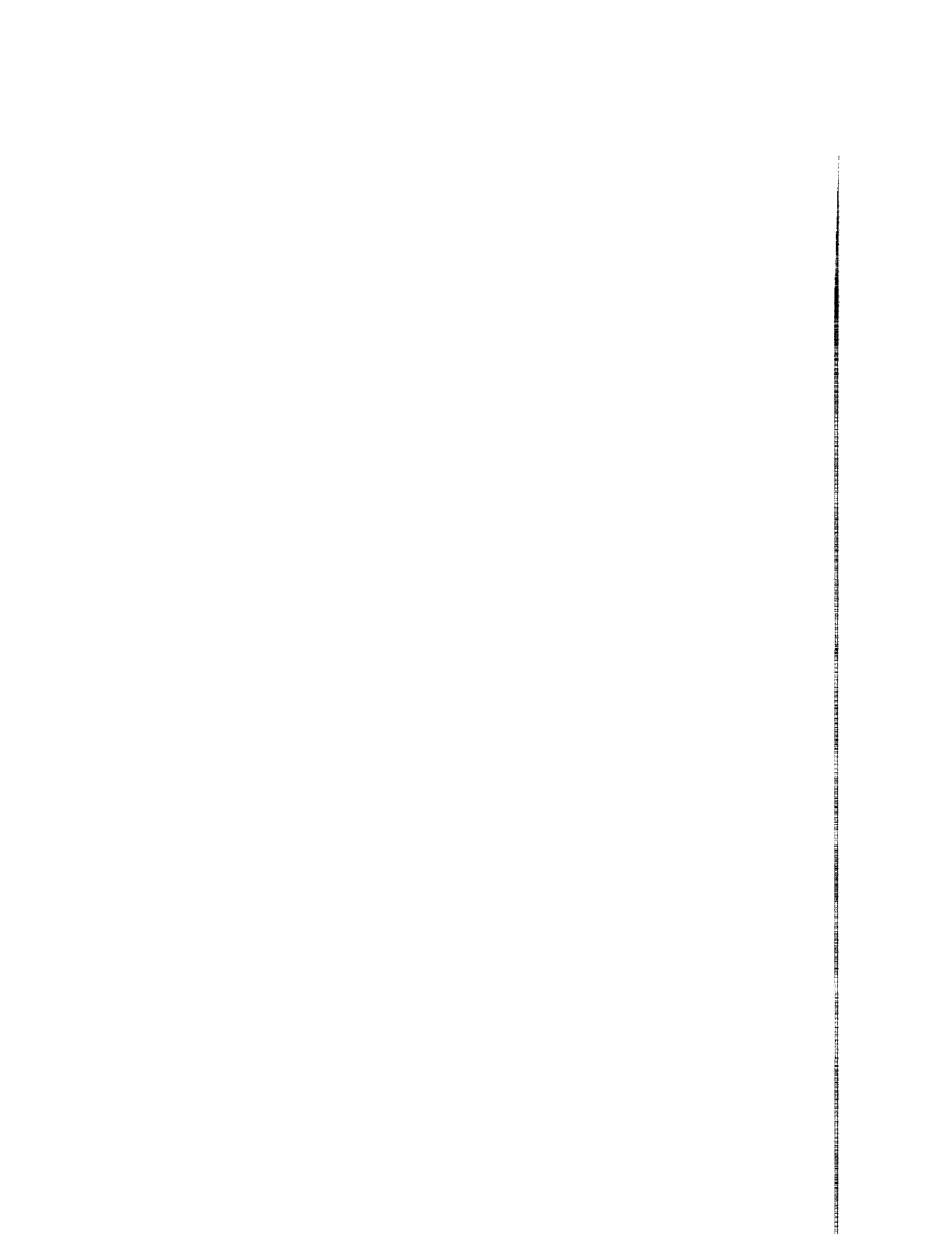

Table VII
Designations for Piloted Space Vehicles

Public Name	KB Name	Production Index	System	First Launch	OKB	Comments
Almaz Complex						
Salyut		11F71 11F711	Almaz OPS	<i>Salyut 2</i>	Chelomey Chelomey and Kozlov	Military system Almaz OPS plus Soyuz 7K-VI
Kosmos		11F712 11F72 11F74 11F75 11F76 11F77 11F667	TKS TKS VA Almaz OPS SpK/KSI TKS FCB Almaz-K/Mech-K	Kosmos-929 Kosmos-881/882 On Salyut 2 On Salyut 2 On Kosmos-929	Chelomey Chelomey Chelomey Chelomey Bugayskiy Chelomey	Almaz OPS plus TKS Transport ship TKS return ship Main part of OPS OPS capsule TKS main module OPS with two ports
Luna and Lunokhod						
Luna	Ye-1			(Sept. 23, 1958)	Korolev	Lunar impact
Luna	Ye-1A			(June 18, 1959)	Korolev	Lunar impact
Luna	Ye-2/Ye-2A			AMS	Korolev	Far side photography
Luna	Ye-3				Korolev	Lunar explosion
Luna	Ye-2F/Ye-3			(April 15, 1960)	Korolev	Far side photography
Luna	Ye-5				Korolev	Far side photography
Luna	Ye-6			(January 4, 1963)	Korolev	Lunar lander
Luna	Ye-6M			Luna 9	Korolev	Lunar lander
Luna	Ye-6S			Kosmos-111	Korolev	Lunar orbiter
Luna	Ye-6LF			Luna 11	Babakin	Lunar orbiter
Luna	Ye-6LS			Kosmos-159	Babakin	Communications test
Luna	Ye-7				Babakin	Lunar orbiter
Luna	Ye-8			Luna 17	Babakin	Lunar rover
Luna	Ye-8-5			Luna 15	Babakin	Lunar lander
Luna	Ye-8LS			Luna 19	Babakin	Lunar orbiter
Luna	Ye-8-5M			Luna 23	Babakin	Lunar lander
Lunokhod	8YeL			Lunokhod (1)	Babakin	Lunar rover

Public Name	KB Name	Production Index	System	First Launch	OKB	Comments
	7K-S-I	11F733			Korolev	Short duration
	7K-S-II	11F734			Korolev	Long duration
	7K-G	11F735			Korolev	OIS tanker
Soyuz	7K-OK	11F615		Kosmos-133	Korolev	Basic Soyuz
Soyuz	7K-T	11F615A8		Soyuz 10	Korolev	DOS ferry
Soyuz	7K-T	11F615A9		Kosmos-656	Korolev	Almaz ferry
Soyuz	7K-TM	11F615A12		Kosmos-638	Korolev	EPAS Soyuz
Soyuz-T	7K-ST	11F732		Kosmos-1001	Korolev	DOS ferry
Soyuz-TM	7K-STM	11F732		Soyuz TM(-1)	Korolev	Mir ferry
Soyuz-TM	7K-STM	11F732		Soyuz TM-16	Korolev	APAS-89 version
		14F70	Zarya		Korolev	Mir-2 crew ferry
Space Shuttles and Spaceplanes						
Buran	OK	11F35		Buran	Korolev and Lozino-Lozinskiy	
Kosmos	BOR-4 BOR-5 LO NPG	14F33 17F32		(Dec. 5, 1980) (June 5, 1984)	Lozino-Lozinskiy Lozino-Lozinskiy Korolev Korolev	Buran payload Buran payload
Space Stations and Modules						
<i>Salyut</i>	17K	11F715	DOS Zarya	<i>Salyut</i> (1)	Korolev	Station
Mir	17KS no. 12701			<i>Mir</i>	Korolev	Station core
SM	17KSM no. 12801 27KS				Korolev Korolev	ISS module Mir complex
Kvant	37KE 377KE 37KD 37KT	11F37	TsM-E TKM-E	Kvant Kvant	Korolev Korolev Korolev Korolev	Astrophysics Kvant plus tug Augment module Tech. module

CHALLENGE TO APOLLO

Public Name	KB Name	Production Index	System	First Launch	OKB	Comments
	37KP 37KG				Korolev Korolev	Remote sensing Cargo module
	37KB 37KBI 37KBE 37KBT		BDP		Korolev Korolev Korolev Korolev	For Buran Research module Power module Biotechnology
Kvant	77KSD	11F77D	TsM-D	Kvant-2	Korolev	EVA module
Priroda	77KSI	11F77I	TsM-I	Priroda	Korolev	Earth observ. module
Spektr	77KSO	11F77O	TsM-O	Spektr	Korolev	Remote sensing
Kristall	77KST	11F77T	TsM-T	Kristall	Korolev	Tech. module
SO	316GK			SO	Korolev	Docking module
FGB	77KSM no. 17501			FCB	Korolev	Core of ISS
		11F71	Soyuz-R		Kozlov	Military station
	OIK	11F730	Soyuz-VI		Korolev	Military station
	OB-VI	11F731			Korolev	OIS base station
	19K		MOK		Korolev	Large station
Sputnik						
Sputnik	PS-1			Sputnik (1)	Korolev	First satellite
Sputnik	PS-2			Sputnik 2	Korolev	Biosatellite
Sputnik	D-1			(April 27, 1958)	Korolev	Scientific
	OD-1				Korolev	Recon. satellite
	OD-2				Korolev	Biosatellite
Vostok and Voskhod						
Korabl-Sputnik	1KP	11F61		Korabl-Sputnik	Korolev	Precursor
Korabl-Sputnik	1K	11F61		Korabl-Sputnik 2	Korolev	Manned precursor
Vostok	3KA	11F63		Korabl-Sputnik 4	Korolev	Manned precursor

Public Name	KB Name	Production Index	System	First Launch	OKB	Comments
Voskhod	3KV	11F63		Kosmos-47	Korolev	Three-person Voskhod
Voskhod	3KD	11F63		Kosmos-57	Korolev	EVA Voskhod
	7K		Vostok-7		Korolev	Upgraded Vostok

Sources

- 1 Various issues of *Novosti kosmonavtiki*
- 2 Sergey Voevodin, *VSA071*, newsletter over Internet. April 30 1997

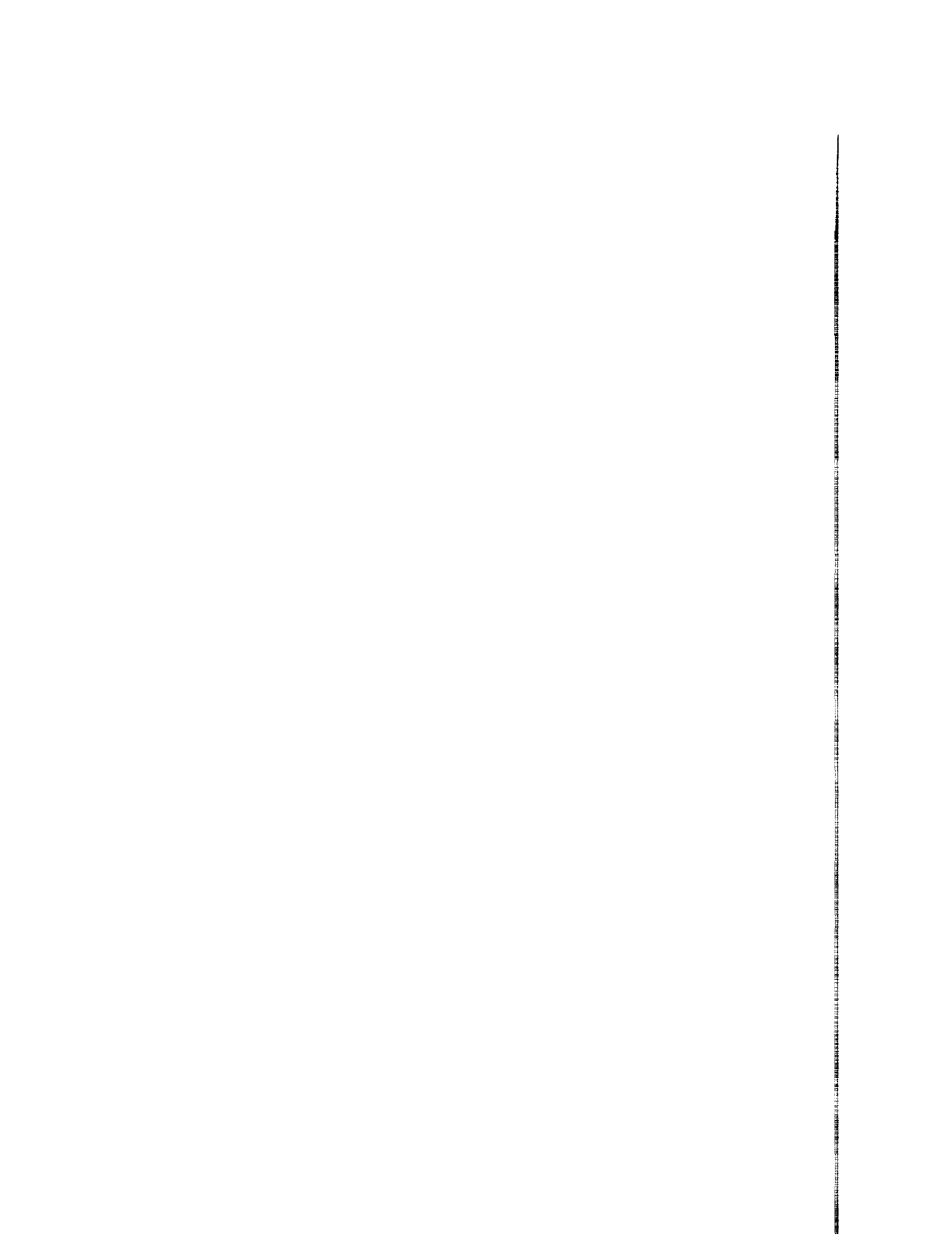

Table VIII
Automated Launches Related to the Soviet Piloted Space Program, 1957-76

Name	Launch Date	Launch Time (Moscow Time)	Spacecraft	S/C No.	Launcher and Serial No.	Comments
Sputnik						
Sputnik	Oct. 4, 1957	2228:34	PS-1	—	8K71PS MI-1PS	Successful launch
Sputnik 2	Nov 3, 1957	0530:42	PS-2	—	8K71PS MI-2PS	Successful launch
Sputnik 3	April 4, 1958	1201	D-1	1	8A91 B1-2	Launcher breakup at T+96.5 seconds
	May 15, 1958	1000:35	D-1	2	8A91 B1-1	Successful launch
Luna						
Space Rocket	Sept 23, 1958		Ye-1	1	8K72 B1-3	First-stage failure, no lunar impact
	Oct. 12, 1958		Ye-1	2	8K72 B1-4	First-stage failure, no lunar impact
	Dec. 4, 1958		Ye-1	3	8K72 B1-5	Second-stage failure, no lunar impact
	Jan. 2, 1959	1941:21	Ye-1	4	8K72 B1-6	Missed Moon, no lunar impact
	June 18, 1959	1108	Ye-1A	5	8K72 11-7	Second-stage failure. no lunar impact
Second Space Rocket Automatic Interplanetary Station	Sept. 12, 1959	0939:42	Ye-1A	7	8K72 11-7B	Successful lunar impact
Station	Oct. 4, 1959	0343:40	Ye-2A	1	8K72 11-8	Successful far side photography
	April 15, 1960	1806:44	Ye-3/Ye-2F	1	8K72 11-9	No escape velocity attained. no photography
	April 16, 1960	1907:43	Ye-3/Ye-2F	2	8K72 11-9A	First- and second-stage failures. far side Photography
Luna 4	Jan. 4, 1963	1149	Ye-6	2	8K78/Ye-6 T103-09	Blok L transformer failure, TLI failure
	Feb. 3, 1963	1229	Ye-6	3	8K78/Ye-6 G103-10	Blok L guidance failure, no Earth orbit
	April 2, 1963		Ye-6	4	8K78/Ye-6 G103-11	Yupiter astro-navigation system failure
	Mar. 21, 1964	1116	Ye-6	6	8K78M/Ye-6 T15000-20	Third-stage valve failure. no Earth orbit
	April 20, 1964	1108	Ye-6	5	8K78M/Ye-6 T15000-21	Blok I and Blok L failure. no Earth orbit
Kosmos-60	Mar 12, 1965	1230	Ye-6	9	8K78/Ye-6 R103-25	Blok L guidance failure, TLI failure
	Apr. 10, 1965		Ye-6	8	8K78M R103-26	Blok I failure, no Earth orbit
Luna 5	May 9, 1965	1049:37	Ye-6	10	8K78M U103-30	Incorrect command to engine landing failure

Name	Launch Date	Launch Time (Moscow Time)	Spacecraft	S/C No.	Launcher and Serial No.	Comments
Luna 6	June 8, 1965	1040	Ye-6	7	3K78 U103-31	Spacecraft guidance failure, landing failure
Luna 7	Oct. 4, 1965	1056:40	Ye-6	11	3K78 U103-27	Loss of s/c orientation, landing failure
Luna 8	Dec. 3, 1965	1346:14	Ye-6	12	3K78 U103-28	Soft-landing failure
Luna 9	Jan. 31, 1966	1441:37	Ye-6M	202/13	3K78M U103-32	First successful landing first s/c built by Lavochkin (202 serial no.)
Kosmos-111	Mar. 1, 1966	1403:49	Ye-6S	204	3K78M N103-41	TLI failure, no lunar orbit
Luna 10	Mar. 31, 1966	1347	Ye-6S	206	3K78M N103-42	First successful lunar orbit
Luna 11	Aug. 24, 1966	1103	Ye-6LF	101	3K78M N103-43	Successful lunar orbit
Luna 12	Oct. 22, 1966	1142	Ye-6LF	102	3K78M N103-44	Successful lunar orbit
Luna 13	Dec. 21, 1966	1317	Ye-6M	205/14	3K78M N103-45	Successful lunar soft-landing
Kosmos-159	May 17, 1967	1344	Ye-6LS	111	3K78M Ya716-56	Insufficient velocity, no lunar orbit
	Feb. 7, 1968		Ye-6LS	112	3K78M Ya716-57	No Earth orbit, launcher failure
Luna 14	April 7, 1968		Ye-6LS	113	3K78M Ya716-58	Successful lunar orbit
	Feb. 19, 1969	0948:15	Ye-8	201	3XZK 239-01 + N0X D	No Earth orbit, launcher failure
	June 14, 1969	0700:47	Ye-8-5	402	3XZK 238-01 + 30X D	Blok D failure
Luna 15	July 13, 1969	0354:42	Ye-8-5	401	3XZK 242-01 + 30X D	Sample returner impacted on Moon
Kosmos 0400	Sept. 23, 1969	1707:36	Ye-8-5	403	3XZK 244-01 + 30X D	Scooper failed to leave Earth orbit
Kosmos 0405	Oct. 22, 1969	1709:59	Ye-8-5	404	3XZK 241-01 + 30X D	Scooper failed to leave Earth orbit
	Feb. 6, 1970	0716:06	Ye-8-5	405	3XZK 247-01 + 30X D	First-stage failure
Luna 16	Sept. 12, 1970	1625:53	Ye-8-5	406	3XZK 248-01 + 30X D	First successful sample return
Luna 17	Nov. 10, 1970	1744:01	Ye-8	203	3XZK 251-01 + 30X D	Released Lunokhod rover
Luna 18	Sept. 2, 1971	1640:40	Ye-8-5	407	3XZK 256-01 + 30X D	Failed sample returner
Luna 19	Sept. 28, 1971	1300:22	Ye-8LS	202	3XZK 257-01 + 30X D	Successful advanced lunar orbiter
Luna 20	Feb. 14, 1972	0627:59	Ye-8-5	408	3XZK 258-01 + 30X D	Second successful sample return
Luna 21	Jan. 8, 1973	0955:38	Ye-8	204	3XZK 283-01 + 30X D	Released Lunokhod 2 rover
Luna 22	May 29, 1974	1156:51	Ye-8LS	206	3XZK 282-01 + 30X D	Successful advanced lunar orbiter
Luna 23	Oct. 28, 1974	1730:32	Ye-8-5M	410	3XZK 285-01 + 30X D	Advanced sample returner crashed on Moon
	Oct. 16, 1975	0704:56	Ye-8-5M	412	3XZK 287-01 + 30X D	No Earth orbit, launch failure
Luna 24	Aug. 9, 1976	1804:12	Ye-8-5M	413	3XZK 288-02 + 30X DM	Third successful sample return
Zond						
Kosmos 1	Nov. 11, 1963	0924	3MV-1A	2	8K78 G103-18	Blok
						Mars test

CHALLENGE TO APOLLO

Name	Launch Date	Launch Time (Moscow Time)	Spacecraft	SIC No.	Launcher and Serial No.	Comments
	Feb. 19, 1964	0848	3MV-1A		8K78 T15000-19	Communications loss with Blok L. Venus test flight. model variously reported as 3MV-1A and 3MV-4
Kosmos-27	Mar. 27, 1964	0625	3MV-1	5	8K78 T15000-22	Blok L power supply failure, Venus lander
Zond 1	April 2, 1964		3MV-1	4	8K78 T15000-23	Lost pressure, no Venus landing
Zond 2	Nov. 30, 1964		3MV-4A	2	8K78	Unopened solar panel, Mars photo failure
Zond 3	July 18, 1965		3MV-4A	3	8K78	Successful lunar far side photography

Sources

1. B. Ye. Chertok. *Rakety i lyudi, goryachiye dni kholodnoy uoyny* (Moscow: Mashinostroyeniye, 1997).
2. K. Lantratov, "Jubilees: 25 Years for Lunokhod-1" (English title), *Nouosti kosmonautiki* 23 (November 5-18, 1995): 79-83.
3. K. Lantratov, "Jubilees: 25 Years for Lunokhod-1" (English title), *Novosti kosmonautiki* 24 (November 19-December 2, 1995): 70-79.
4. Christian Lardier, *L'Astronautique Sovetique* (Paris: Armand Colin, 1992).
5. Jonathan McDowell, April 26, 1994 and July 31, 1994, personal correspondence to the author.
6. Timothy Varfolomeyev, "Soviet Rocketry that Conquered Space. Part 1: From the First ICBM to Sputnik Launcher." *Spaceflight* 37 (1995): 260-63
7. Timothy Varfolomeyev, "Soviet Rocketry that Conquered Space. Part 2: Space Rockets for Lunar Probes." *Spaceflight* 38 (1996): 49-52.
8. Timothy Varfolomeyev, "Soviet Rocketry that Conquered Space: Part 5: The First Planetary Probe Attempts." *Spaceflight* 40 (1998): 85-88.

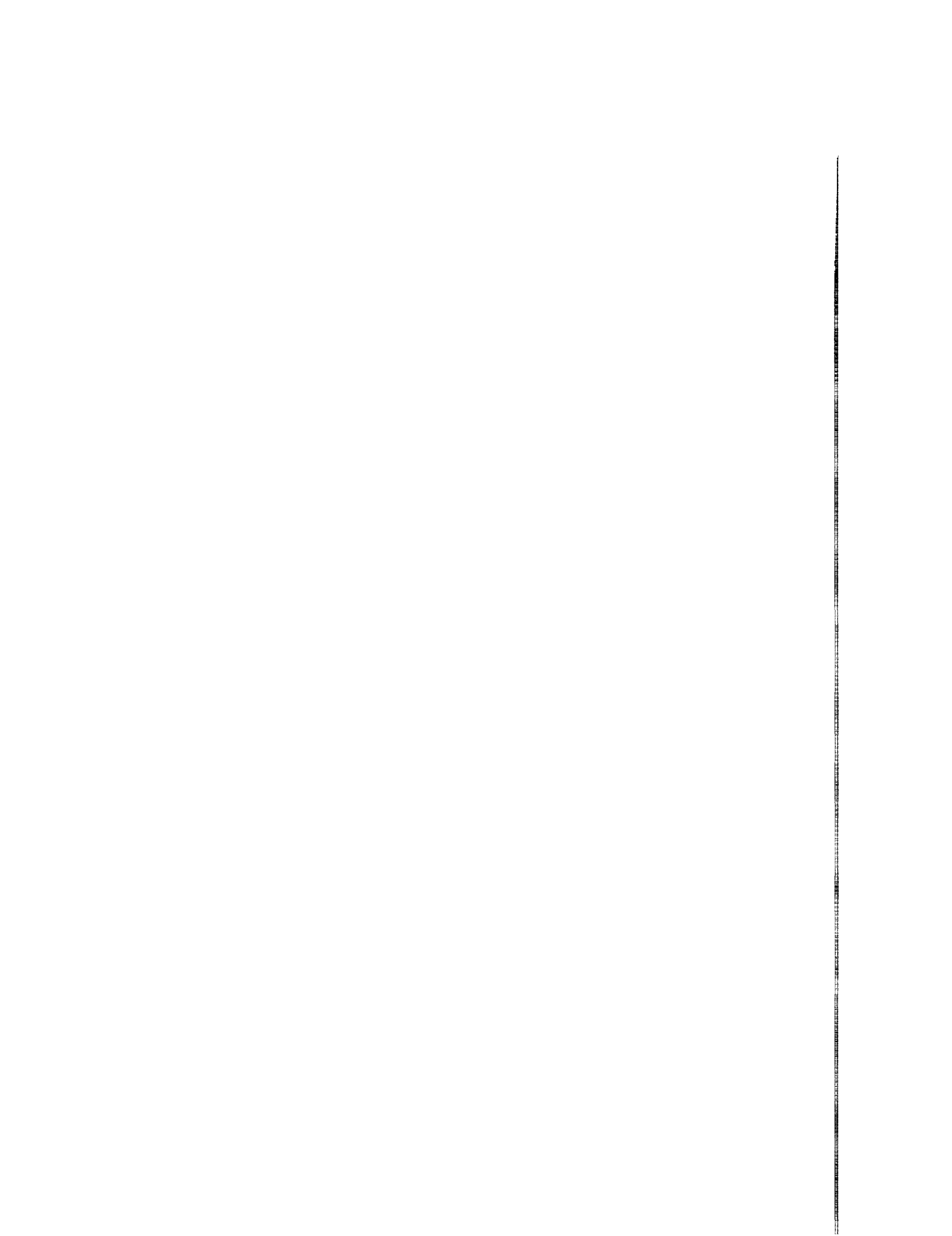

Table IX
Governmental Decrees in the Soviet Missile and Space Programs, 1945-76

Date	Decree No.*	Title of Decree and Description	Issuing Body**
1945			
January 18	7350	On tasking OKB-51 to develop a copy of the Fi-103 missile	NKAP
May 26	8803	"On Measures to Reconstruct Industry in Connection with Maintaining Production of Armaments"—postwar rearmament plan	CKO
August 20	9887/ss/op	"On a Special Committee Under the GKO's Jurisdiction"—creation of Special Committee and its subordinate First Chief Directorate of GKO (later of Council of Ministers) for the development of atomic bomb	CKO
November 30		On organization of Special Design Bureau for rocket technology at Plant No. 88	NKA
1946			
May 13	1017-419ss	"Questions of Reactive Armaments"—formation of Special Committee for Reactive Technology (later Special Committee No. 2) of Council of Ministers for the coordination of work on missiles	SM
June 21		On establishment of NII-4	-
July 3	424	On redirecting Plant No. 456 at Khimki for the production of rocket engines	MAP
July 14		On establishment of BON of Fourth Directorate of GAU in Ministry of Armed Forces	-
August 9	83-K	On appointment of S. P. Korolev as Chief Designer of R-1	MV
August 26		On establishment of structure of NII-88	-
August 30		On appointment of S. P. Korolev as Chief of Department No. 3 of NII-88 SKB	-
September 29	1167	On establishment of OKB-456 at Plant No. 456 at Khimki	SM

Date	Decree No. *	Title of Decree and Description	Issuing Body**
1947			
July 26	2643-818ss	On testing of two series of A-4 rockets in 1947	SM
July 27		On establishment of GTsP-4 at Kapustin Yar	MVS
1948			
April 14		On work on the R-1 and R-2 missiles	SM
June 11	2018-791	On construction of a test site to ground-test rocket engines	SM
July 7	256	On establishment of NII Branch No. 2 to ground-test rocket engines	MV
1949			
December 27	5744-2162	On creation of Second Chief Directorate of Council of Ministers to manage uranium mining	SM
December 30		On work on geophysical variants of the R-1 missile	SM
1950			
April 26		On creation of OKB-1 within Nil-88	MV
August 13	3456-1446	On termination of the work of German scientists in the Soviet missile program	SM
November 28		On adoption of the R-1 into armaments	SM
December 4		On themes N1, N2, and N3 in the ballistic missile program	SM
December 7	947-712	On transfer of OKB-456 from the Ministry of Aviation Industry to the Ministry of Armaments	SM
1951			
February 3		On creation of the Third Chief Directorate of Council of Ministers to manage missile programs	SM

Date	Decree No."	Title of Decree and Description	Issuing Body *
May 9		"On the Transfer of the Dnepropetrovsk Automobile Plant From the Ministry of Automobile and Tractor Industry to the Ministry of Armaments"—transfer of Dnepropetrovsk Plant No. 586 into the Ministry of Armaments for missile production	SM
May 24		On formation of OKB-23 at Fili	SM
June 1		On starting of series production of the R-1 at Dnepropetrovsk Plant No. 586	MV
November 27	4972-2096	On adoption of the R-2 into armaments	SM
November 30		On starting of series production of the R-2 at Dnepropetrovsk Plant No. 586	MV
1953			
February 13		On approval of work on themes T1 and T2, on approval of work on the R-5, R-11, and EKR missiles, and on transferring draft plan work for the R-12 from NII-88 to SKB-586	SM
February 18		On formation of AN SSSR Commission for Research on the Upper Layers of the Atmosphere	AN SSSR
February 19	533-271	On dissolution of OKB-51 and its transfer to OKB-155	SM
March 16		On uniting the First and Second Chief Directorates of Council of Ministers	SM
March 27		On renaming the Ministry of Armaments to the Ministry of Defense Industry	SM
April 18		On formation of UZKA of CAU	MVS
July 1		On unification of the First and Third Chief Directorates of Council of Ministers into the new Ministry of Medium Machine Building	SM
July 29		On transferring all missile work on guided missiles to the Ministry of Medium Machine Building	SM
September 23	2498-1031	On order of scientific-design work on new weapons systems	SM

Date	Decree No.*	Title of Decree and Description	Issuing Body**
1954			
January 26		On approval of work on the R-11FM	SM
March 17		On selection of launch area for the R-7, 40 Buran, and 350 Burya	SM
April 10		On approval of work on the R-5M missile and on establishment of OKB-586 at Dnepropetrovsk Plant No. 586	SM
May 20	956-4088s	On approval of work on the R-7 ICBM, R-5R, and MSRDR missiles	SM
May 20	957-409	On transfer of intercontinental cruise missile work to the Ministry of Aviation Industry	SM
June 9		On establishment of Special Design Group 10 at Plant No. 500 at Tushino under V. N. Chelomey	MAP
June 28		"On NIP Plan for Special Product" —course of work on the R-7 ICBM	SM
July 9		On appointment of M. K. Yangel as Chief Designer of OKB-586	-
August 26		On approval of work on the R-11M missile	SM
November 20		On approval of the R-7 draft plan	SM
1955			
February 3		On creation of the submerged submarine-launched ballistic missile	SM
February 12	292-181	"On New Range for the USSR Ministry of Defense" —establishment of NIIP-5 at Tyura-Tam	SM
April 14		On creation of Special Committee for Armaments of the Army and VMF (later VPK) of Council of Ministers to manage missile programs	SM
July 13		On adoption of the R-11 into armaments	SM

CHALLENGE TO APOLLO

Date	Decree No.*	Title of Decree and Description	Issuing Body**
August 8		On establishment of OKB-52 at Reutov	TsK and SM
August 13		"On the Creation and Preparation of the R-12 (8K63) Missile" —start of work on the R-12	SM
1956			
January 30	149-88s	On creation of the Object D artificial satellite	SM
March 20		On means to ensure testing of the R-7	TsK and SM
June 20		On <i>production</i> of the R-5A and R-2A scientific missiles at Plant No 586	MOP
June 21		On adoption of the R-5M into armaments	
July 11		On approval of work on the R-11A missile for the IGY	-
August 14	310	On separation of OKB-1 from NII-88	MOP
August 31		On creation of the State Commission for the R-7	SM
September 3	1241-632	On creation of the Command-Measurement Complex	TsK and SM
September 30		On approval of the draft plan for Object D	VPK
December 17		"On the Creation of the Intercontinental Ballistic Missile R-16 (8K64) with Start of LKI in June 1961" —start of work on the R-16 ICBM	SM
1957			
January 11	61-39ss	On creation of launch complex Angara at NIIP-53	SM
January 11		On approval of flight-testing program for the R-7 ICBM	SM
February 15	171-83ss	"On Measures to Carry Out During the International Geophysical Year" —launch of simple satellites in mid-1957	SM

Date	Decree No. *	Title of Decree and Description	Issuing Body**
May 10		"On Future Improvements in the Organizational Control of Industry and Construction"—abolishing the branch ministry system	VS SSSR
August 20		On transfer of two R-12 missiles to China (or August 6?)	MV
November		On termination of work on the 40 Buran intercontinental cruise missile	SM
November 6		On subordinating OKB-52 to GSNII-642	MAP
December 14		On creation of the Military-Industrial Commission on the basis of the Special Committee of the Council of Ministers and on change of the defense industry system from ministries to State Committees	TsK and SM
<hr/>			
1958			
January 2		On adding of space work to Plant No. 1 (later Progress Plant) at Kuybyshev	
January 29		On renaming town of Zarya to Leninsk at site 10 at Tyura-Tam	Kazakh VS
March 8	293-140	On subordinating GSNII-642 to OKB-52	MAP
March 20		On work on automated lunar probes and three-stage launch vehicles for them	-
March 20		On creation of Branch No. 1 of OKB-456	-
March 24		"On the Creation of the Burya Winged Missile"-course of work on 40 Burya	GKOT
April 1		On adoption of the R-11M into armaments	
April 3		On creation of OKB1 branch at Progress Plant	
April 11		On creation of Branch No. 1 of OKB-456	GKOT
June 30		"On the Creation of Rockets With Engines on the Basis of Nuclear Energy Applications"—work on a draft plan for rockets with nuclear engines	TsK and SM

Date	Decree No.*	Title of Decree and Description	Issuing Body**
July 2	726-346	On start of work on the R-14 missile, on creation of the R-7A ICBM, and on creation of the winged-ballistic rocket at OKB-52	TsK and SM
August 28		On expansion of work on the R-16 ICBM	
September 2		On launch of automated lunar probes	
November		On course of work on the piloted spaceship	SCK
December 6	1550-659	On reorganization of the missile and space industry	SM
1959			
January 5	22-10ss	On biomedical preparations for human spaceflight	TsK and SM
January 16		On separation of OKB-2 from NII-88	-
February 20		On adoption of the R-11FM into armaments	
March 4		On adoption of the R-12 into armaments	-
March 14		"On Work on the R-7 Product and Flight-Design Testing of the R-7A Product"—testing of the R-7 and R-7A ICBMs	TsK and SM
April 1		On production of the R-7A missile at Plant No. 1001 at Krasnoyarsk-26 and establishment of a branch	TsK and SM
May 13		On start of dedicated work on the R-9 and R-16 ICBMs	TsK and SM
May 13		On creation of the Computer Center of NII-88	
May 22	569-264	On work on a reconnaissance satellite and piloted spaceship	TsK and SM
June 4	191	On creation of OKB-1 Branch No. 2 at Krasnoyarsk-26	GKOT
July 3		On attaching of TsNII-58 for solid-propellant work to OKB-1	GKOT

CHALLENGE TO APOLLO

Date	Decree No.*	Title of Decree and Description	Issuing Body**
July 15		On formation of the Design Department of OKB-1 at the Progress Plant in Kuybyshev	
November 15		On tasking NII-4 to create a sea-based communications network	TsK and SM
December 10		"On the Development of Research on Cosmic Space" —future of Soviet space program (piloted, interplanetary, spaceplane)	TsK and SM
December 10	1386-618	"On the Creation of AMS for Landing on the Moon, and Flights to Venus and Mars" — approving automated lunar and interplanetary spacecraft	TsK and SM
December 17	254	"On the Establishment of the Post of Commander-in-Chief of Missile Forces in the Armed Forces of the SSSR" —creation of the Strategic Missile Forces	TsK
December 17	1384-615	"On the Establishment of the Post of Commander-in-Chief of Missile Forces in the Armed Forces of the SSSR" —creation of the Strategic Missile Forces	SM
1960			
January 11		On creation of the Cosmonaut Training Center	VVS
January 20		On adoption of the R-7 ICBM into armaments	
February 5	138-48	On termination of work on the La-350 Burya at OKB-301	
February 22	236-89	On creation of the State Commission for the R-16 ICBM	SM
May 9		On approval of work on the Elektron scientific satellite	TsK and SM
June 4	587-238	"On the Realization of the Plan to Master Cosmic Space in 1960 and the First Half of 1961" — creation of a four-stage launcher for interplanetary missions and schedule for the Korabl-Sputniks	TsK and SM
June 14		On creation of shaft units (silos) for the R-12, R-14, R-16, and R-9 missiles	GKOT
June 23	715-295	On approval of preliminary work on the Raketoplan, UR-200 ICBM, and IS anti-satellite system	-
June 23	715-296	"On the Creation of Powerful Booster Rockets, Satellites, Spacecraft and the Mastery of Space in 1960-67" —future of Soviet space program	TsK and SM

Date	Decree No.*	Title of Decree and Description	Issuing Body**
August 3		On training of cosmonauts only at the Cosmonaut Training Center	SM
August 3		On naming June 2, 1955, as the birthday of NIIP-5	MO
August 8		"On the Creation of the Rocket-Carrier 6351 Based on the R-12 Missile. and the Development and Launch of 10 Small ISZ" —start of work on launcher and satellites at OKB-586	TsK and SM
August 30	866-361	"On the Status of Cosmonauts" —medical requirements for cosmonauts	
September 12		On adoption of the R-7A into armaments	-
October 3	1057-434	On transfer of OKB-23 as Branch No 1 of OKB-52 and on course of work on IS anti-satellite system	
October 11		On plan to launch the first human in space on Vostok	TsK and SM
1961			
During the year		On formalizing powers of the Council of Chief Designers	-
March 16	420-1741	On approval of work on the US satellite and UR-200 launch vehicle/ICBM	TsK and SM
April 3		On approval for launch of Vostok	TsK Presidium
April 24		On adoption of the R-14 missile into armaments	-
April 27		"On the Organization of Military Duty of the R-16U (Unified Variant)" — putting the R-16U missile into operation	GKOT
May 13		"On the Revision of Plans for Space Objects to Directions for Accomplishing Goals of Defense Designations" —heavy boosters, course of work on Elektron, and suspension of work on the Kosmoplan and Raketoplan with continuation of new Raketoplan work	TsK and SM
July 3		On naming OKB-23 plant after M. V. Khrunichev	SM

CHALLENGE TO APOLLO

Date	Decree No.¹	Title of Decree and Description	Issuing Body*²¹
August 1		On course of work on the UR-200 missile and launcher	TsK and SM
October 20		On adoption of the R-16 into armaments	
October 30		On plans for the military use of space during the period 1961-65	TsK and SM
October 30		On approval of work on the Molniya-1 communications satellite and Meteor-1 weather satellite	TsK and SM
October 31		"On the Creation of the Space Carrier 6553" —start of work on a launch vehicle based on the R-14 and Meteor, Strela, and Pchela satellites	TsK and SM
December 18		On establishment of the Independent OKB-10 at Krasnoyarsk-26 on the basis of OKB-1's Branch No. 2	GKOT
December 30	10/19	On selection of sixty new cosmonauts, including five women	TsK and SM
1962			
March 23		On Luna spacecraft for soft-landing on the Moon	TsK and SM
April 13		On restriction of work on the NI	
April 16		"On Important Development of Intercontinental Ballistic and Global Missiles and Carriers-Rockets for Space Objects" —work on the NI, R-36, R-36-O, and R-56	
April 16		"On the Development of the 'Soyuz' Complex for Piloted Flight to the Moon" —approving the Soyuz program for circumlunar flight	TsK and SM
April 29		On start of work on the UR-500 missile and carrier-rocket	SM
June 3		On course of work on the US reconnaissance satellite system launched on the UR-200	-
June 27		On formation of the Scientific-Technical Council of the Strategic Missile Forces	MO
September 24	1021-436	On start of work on the NI and CR-1	TsK and SM

Date	Decree No.*	Title of Decree and Description	Issuing Body**
October 13	640106	On start of work on the GR-I	GKOT
1963			
January 2	15-5	On creation of the space and missile cosmodrome at NIIP-53 at Mirnyy/Plesetsk	-
February 8	24	"On the Manufacture of 'Vostok' Objects"—manufacture of Vostok spacecraft in 1963	VPK
March 21		On approval of work on the Soyuz complex	MNTS-KI
March 21		On preparation of proposals on launches of Vostok spacecraft	TsK and SM
April 13		On plans for Vostok launches in 1963	TsK and SM
June 15		On adoption into armaments of the R-16 surface variant	-
July 15		On adoption into armaments of the R-12U, R-14U, and R-16U shaft versions	-
August 30		On formation of NIIP-53 at Angara	MO
September 16	999-347	On creation of the space and missile cosmodrome at NIIP-53 at Mirnyy/Plesetsk	-
October		"Program for Space Investigations With Small ISZ. Launched on the Kosmos RN"—course of work on small satellites at OKB-586	
November 13		On approval of the schedule of work for the NI launch complexes	VSNKh
December 3		On approval of work on the Soyuz 7K-9K-11K circumlunar complex	TsK and SM
December 24		On ensuring the manufacture of ground equipment for the NI	
1964			
January 9		On adoption of the R-12U and R-14U shaft versions into armaments	-
March 10	0045	On adopting the Zenit-2 satellite launched on the 8A92 into armaments	MO

CHALLENGE TO APOLLO

Date	Decree No.¹	Title of Decree and Description	Issuing Body**
March 13	59	On approval of work to convert Vostok to Voskhod and use it for three-person space missions	VPK
April		On appointing KB TM as main space launch pad design organization	-
April 13		On approval of work on four Voskhods and five EVA-equipped Vykhdos	TsK and SM
May 22		On termination of work on the Kosmoplan and Raketoplan at OKB-52 and approval for the LK-1	TsK and SM
June 14		On approval of work on Voskhod and Vykhdod	
June 18		On military space programs for 1964-69, including the R spaceplane	MO
June 19		On termination of work on the R-56 launch vehicle and on schedule of the testing for the NI	
August 3	655-268	"On Work on the Exploration of the Moon and Mastery of Space"—piloted LK-1 circumlunar and L3 lunar landing projects and the Ye-6M lunar lander	TsK and SM
August 3		On formation of the State Commission for Voskhod	TsK and SM
October		On formation of TsUKOS in the Strategic Missile Forces	MO
October 28		On assignment of lunar programs to OKB-52 and OKB-1	VPK
<hr/> 1965 <hr/>			
During the year		On end of work on the Raketoplan at OKB-52	-
During the year		On plan of work on Spiral at OKB-155	
During the year		On work on space stations at OKB-52	TsK and SM
January 12		"On Detailed Work on Ampulized R-36 and R-36-O Missiles"—design work on the R-36 and R-36-O missiles	GKOT
February 10		On approval of the L3 draft plan	MNTS-KI

Date	Decree No.*	Title of Decree and Description	Issuing Body**
March 2	126-47	"On Improved Leadership of Defense Branch Industry"—creation of ministries for aviation, defense, ship building, radio-technology, electronics, and general machine building for managing the Soviet defense industry	TsK and SM
April 15		"On Cooperation of the USSR and Socialist Countries in the Sphere of Research and Use of Space"—international cooperation	TsK and SM
May 15		On establishment of the Institute of Space Research in the USSR Academy of Sciences on July 14, 1965	TsK and SM
June 22		"On Preparations in 1965-66 of 18 Small Unifunctional Earth Satellites for Carrying out Scientific Investigations"—creation of small scientific satellites at OKB-586	MOM
July 21		On adoption of the R-9A in shaft and surface variants into armaments	
July 28	156	"On the Manufacture of 'Voskhod' Space Ship-Satellites"—manufacture of five more voskhod spacecraft	VPK
August		On creation of military Voskhod and Soyuz spacecraft	VPK
August 18	180	"On the Order of Work on the Soyuz Complex"—approval of the schedule of work for Soyuz spacecraft	VPK
August 24		"On Creation of an R-36 Based Carrier Rocket for Launching the IS and US KA"—start of work on an R-36-based launch vehicle for the IS and US programs	
August 24		On expansion of military space research and on 7K-VI Zvezda	TsK and SM
September 6		On delays in work on piloted lunar programs	MOM
October 20		On approval of work on the draft plan of the UR-700-LK-700 lunar complex	MOM
October 25		"On the Concentration of Forces of Industrial Design Organizations for the Creation of Rocket-Space Complex Means for Circling the Moon"—work on the UR-500K-LI program	TsK and SM

CHALLENGE TO APOLLO

Date	Decree No.*	Title of Decree and Description	Issuing Body**
November 13		On work on the UR-500K-L1 program	MOM
1966			
February 22		"On Performing in March 1966 the Launch of 3KV n6 With Two Cosmonauts. for Solving Problems of Extended Space Flight (18-20 Days)" —course of Voskhod-3 preparations	TsK and SM
March 6		On renaming OKB-1 as TsKBEM and OKB-52 as TsKBM	MOM
March 30	145ss	On approval of the 7K-TK as transport for the Almaz station	MOM
April 27	101	"On Approving the Work Plan to Build the Piloted Spacecraft 7K L1" —approving the plan for the UR-500K-L1 and terminating the UR-500K-LK-1	VPK
May 15	144	On assessing preparations for flights of the 7K-OK spacecraft	VPK
May 23	43 or 47	On creation of the civilian detachment of cosmonauts	OKB-1
June 15	144	On preparation of crews for the 7K-OK spacecraft and civilian cosmonauts	VPK
June 21		On long-range military use of space in 1966-70	TsK and SM
September		On approval of the N 1-13 mission profile	AN SSSR
September 14		On course of work on the N1-L3	VPK
September 17		On creation of a commission to compare the UR-700-LK-700 and the N1-L3	MOM
October		On renaming OKB-586 as KB Yuzhnoye	—
November		On lag of work on the N1-L3 and UR-500K-L1 programs	VPK
December 28	304	On changes in the timeline for the Almaz program and suspension of the 7K-TK	VPK
December 28	305	On approval of work on the 7K-VI Zvezda and course of work on Almaz	VPK

Date	Decree No.¹	Title of Decree and Description	Issuing Body**
1967			
During the year	0015	On transfer of Zenit-2 from the 8A92 to the 11A57 launcher	MO
February 4	115-46	"On the Progress of the Work on the Development of the UR500K-L1"—confirmation of schedule for piloted lunar missions	TsK and SM
February 9		On approval of work on Almaz	MOM
February 14		On construction of the NI payload fairing by the Khrunichev Plant	MOM
March 15	42	On search service for returning missions from the Moon	VPK
March 27	270-105	"On Preparation of Cosmonaut-Testers and Cosmonaut Researchers"—formation of group of research and test-cosmonauts to support future missions	TsK and SM
March 30		On formation of Anti-Space and Anti-Missile Forces of the Air Defense Forces (RKO) to operate Soviet ASAT systems	MO General Staff
April 22	145	"On the Preparation of Test-Cosmonauts and Research-Cosmonauts"—selection of the group of engineer-cosmonauts under the Ministry of General Machine Building	MOM
May		On adoption into armaments of the Raduga complex of DS-PI-YU	-
June		On full approval of the Almaz and 7K-TK programs	TsK and SM
June 21		On approval of the Almaz draft plan	VPK
July		On use of the R-36-based launcher for the Kosmos and Meteor satellites	SM
July 21		On approval of the R-36 ICBM variant with means to overcome PRO and on adoption of the R-36 ICBM into armaments	
July 21	715-240	"On the Creation of Space Systems for Naval Reconnaissance Comprising the US ISZ and the Rocket-Carrier on the Basis of the R-36"—further work on the US naval reconnaissance satellite, approval of work on the Yantar-2K, and course of work on the 7K-VI Zvezda and OIS	

Date	Decree No. *	Title of Decree and Description	Issuing Body *
July 24	220	On approval of work on the Yantar-2K	MOM
August 14		On schedule of work on the Almaz space station	TsK and SM
November 14		On revision of the timetable for the NI-L3	
November 17	1070-363	On approval of work on the UR-700 launch vehicle	TsK and SM
1968			
February 21		"On Introduction of Hydrogen in Rocket-Space Technology" — future of liquid hydrogen stages	TsK and SM
March 11		On formation of the Space Branch of NII-4	
March 13		On approval of the training program for lunar cosmonauts	VVS
March 19	88	On use of liquid hydrogen in the space program	MOM
May 27	163	On formation of a new group of engineer-cosmonauts under MOM	MOM
October 24		On establishment of the Kristall communications system based on Molniya-2 satellites	TsK and SM
October 28		On renaming of Zelenyy as Zvezdnyy gorodok	Moscow Oblast Exec Committee
November 19		On adoption of the R-36-O into armaments	
1969			
January 8	19-10	"On Work on Research of the Moon, Venus and Mars by Automatic Stations" — work on automated lunar and Interplanetary spacecraft	TsK and SM
June 30	232	On start of work on the UR-700M rocket	MOM

Date	Decree No.*	Title of Decree and Description	Issuing Body**
1970			
January 2		"On the Creation of the Carrier-Rocket 11K68 on The Basis of 11K69 RN and S5M Stage for Launch of Space Apparatus 'Tselina' and 'Meteor'" — approval of work on the Tsiklon-3 RN	TsK and SM
February 9	105-41	On creation of the DOS using Almaz as a basis	TsK and SM
February 16	57ss	On creation of the DOS using Almaz as a basis	MOM
March		On formation of GUKOS on the basis of TsUKOS and subordinated to RVSN	MO
June 4		On standardized weather satellite system	VPK
June 16	437-160	On creation of the TKS and termination of the 7K-TK	TsK and SM
1971			
June 8		On work on nuclear rocket engines	-
September		On cooperatton to build an Indian satellite	TsK and SM
October		"On the Development of a System of Global Television Reconnaissance (TGR)—'Tayfun' ISZ" —approval of work on the Tayfun reconnaissance satellite	-
October		"On the Development of an Adjustment Complex with the 'Tayfun-2' ISZ" —approval of work on the Tayfun-2 system	-
December 21		"On Expansion of Work on Research of the Earth's Natural Resources by Space Systems Technology" —Meteor-Priroda system	TsK and SM
1972			
February 16		On approval of work on the draft plan for the NI-L3M two-launch lunar landing proposal	VPK
February 23		On work on the technical proposal for the creation of the MOK	VPK

Date	Decree No.*	Title of Decree and Description	Issuing Body**
March 26		On adoption of Tselina-O into armaments	TsK and SM
April 5		On use of Molniya and Gran for a unified satellite communications system	TsK and SM
May 15		On approval of the NI-L3M proposal	SCK
June 15		On schedule of work for the Almaz and TKS programs	MOM
June 26		"On the Creation of Automatic Universal Orbital Stations (AUOS)"—on approval of work on the AUOS satellite bus	MOM
September		On termination of production work on the L3	
September 25		On formation of TsNII-50 on the basis of NII-4's Space Branch	-
November 19		"On Cooperation of USSR and India on Space Research"—USSR-India cooperation	TsK and SM
December 16		On establishment of the Planeta-S weather satellite system	VPK
1973			
February		On adoption of the Tayfun-1 into armaments	TsK and SM
March 26	182-63	On development of the Yantar-1KFT reconnaissance and cartographic satellite and the IASIK launcher	TsK and SM
December		"On Carrying out Work on Reusable Space Systems"—response to NASA's Space Shuttle	VPK
1974			
May 19		On suspension of further launches of the NI	MO
May 22		On formation of NPO Energiya	-
June 21		On establishment of the State Commission for testing the Soyuz-T	VPK

TABLE IX

Date	Decree No.*	Title of Decree and Description	Issuing Body**
June 24		On suspension of work on the NI-L	NPO Energiya
July 30		On separation of TsSKB from NPO Energiya and creation of the Volzhkiy Branch	-
December 31	314	On development of the Topaz-1 thermionic nuclear reactor for Plazma-A spacecraft	VPK
1975			
June 5	178	On development of the IIA511U2 launch vehicle	MOM
September 21		On USSR-France cooperation in space	TsK and SM
October		On adoption of US-A with Tsiklon-2 into armaments	-
1976			
January 19	46-13	On course of work on Almaz and the TKS	TsK and SM
February 3		On USSR-France cooperation in space	TsK and SM
February 17		On work on Energiya-Buran, DOS-7K nos. 7 and 8, Gamma, Gevzer, and Altair and cancellation of the NI	TsK and SM
February 27		On long-range military use of space up to 1990	TsK and SM
March 16		"On the Creation of a Universal Space Missile Complex IK77 'Zenit'"—approval of work on the Zenit launcher	TsK and SM
May 31	409-147	"On Creation of Yantar-1KFT Space Complex for Solving Goals of Cartography"—development of the Yantar-1KFT reconnaissance satellite	TsK and SM
June 11		On selection of design layout for Buran	SGK

Date	Decree No.*	Title of Decree and Description	Issuing Body**
June 15		On course of work on nuclear rocket engines	
November 8		On approval of a tactical-technical requirement for Buran	MO
December		"On Expansion of the Global Navigation Satellite System (CLONASS) Single Space Navigation System"—development of CLONASS	TsK and SM
December 10		On adoption of the Tselina-D into armaments	TsK and SM
December 10	342	On development of the Topaz-I thermionic nuclear reactor for Plazma-A spacecraft	VPK
December 18		On course of work on Energiya-Buran	VPK

* All known decrees related to the Soviet space program in the period 1945-76 are shown above. All decrees related to ballistic missile development in the period 1945-57 are shown. In the period 1958-76, only the R-7A, R-9, and R-16 ICBMs are shown.

** Acronyms for the issuing bodies are as follows

AN SSSR	USSR Academy of Sciences
CKO	State Committee for Defense
CKOT	State Committee for Defense Technology
MAP	Ministry of Aviation Industry
MNTS-KI	Interdepartmental Scientific-Technical Council on Space Research
MO	Ministry of Defense
MOM	Ministry of General Machine Building
MOP	Ministry of Defense Industries
MV	Ministry of Armaments
MVS	Ministry of Armed Forces
NKA	People's Commissariat of Armaments
NKAP	People's Commissariat of Aviation Industry
SGK	Council of Chief Designers
SM	Council of Ministers
TsK	Central Committee
VPK	Military-Industrial Commission
W S	The Air Force
VS SSSR	USSR Supreme Soviet
VSNKh	All Russian Council of the National Economy

APPENDICES

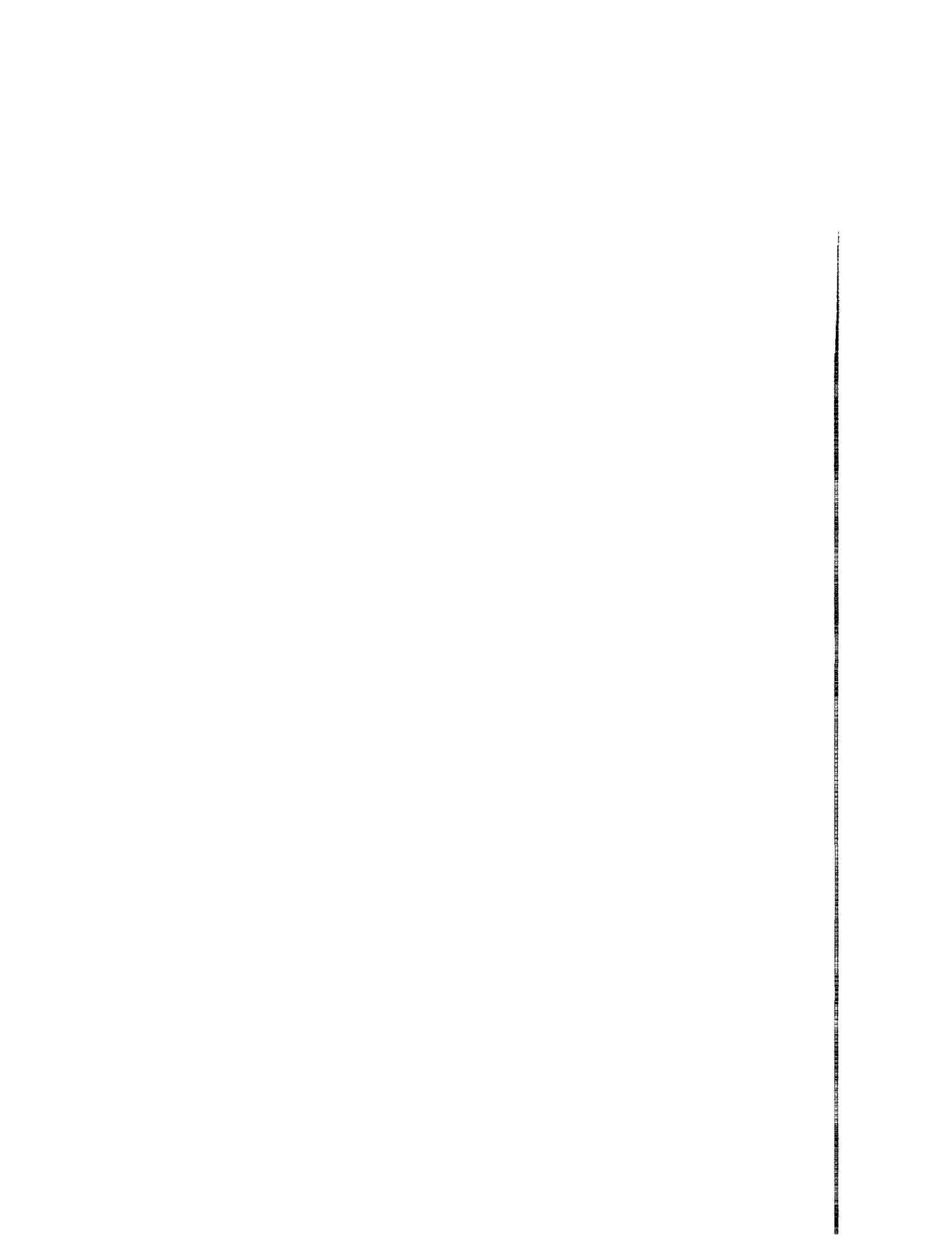

APPENDIX A

Appendix A Soviet Piloted Space Projects, 1945-74

1. VR-190

Lead institutions	NII-1 (1945-46), NII-4 (1946-49)
Lead designer	M. K. Tikhonravov
Initiation of studies	1944-45
Project termination	1949
Spacecraft	VR-190
Launch vehicle	A-4 derivative
Objective	Launch of "stratonauts" on vertical flights to upper atmosphere

2. Antipodal Bomber

Lead institutions	NII-1 TsIAM
Lead scientists	M. V. Keldysh, V. F. Bolkhovitinov
Initiation of studies	1945-46
Preparation of design documentation	1947
Project termination	1950
Spacecraft	Sanger-Bredt winged bomber
Objective	Transatlantic upper atmospheric piloted flight

3. Vertical/Suborbital Program

Lead institutions	NII-88 OKB-1, OKB-1
Chief Designer	S. P. Korolev
Lead designer	N. P. Belov
Initiation of studies	April 1955
Preparation of design documentation	May 1956
Termination of studies	November 1958
Launch vehicles	R-1Ye, R-2A
Objective	Launch of humans on vertical and suborbital trajectories

4. Vostok

Lead institution	OKB-1
Chief Designer	S. P. Korolev
Deputy Chief Designer (for Vostok)	K. D. Bushuyev
Chief of Planning Department (for Vostok)	M. K. Tikhonravov
Group Chief (for Vostok)	K. P. Feoktistov
Lead designers	O. G. Ivanovskiy, Ye. A. Frolov
Initiation of studies	April 1957
Preparation of design documentation	August 18, 1958
Approval by Council of Chief Designers	November 1958
TsK KPSS/SM approval	January 5, 1959; May 22, 1959
Draft plan signed	April-May 1959 (for 1K); July 31, 1961 (for 3KA)
First orbital launch attempt	May 15, 1960 (Korabl-Sputnik)
Last orbital launch attempt	June 16, 1963 (Vostok 6)
Program termination	March-April 1964
Spacecraft	1K/11F61, 3KA/11F63
Launch vehicles	8K72/Luna, 8K72K/Vostok
Objective	Piloted orbital flight with a single cosmonaut

5. Gliding Cosmic Apparatus (PKA)

Lead institutions	OKB-256 (spacecraft), OKB-1 (launcher)
Chief Designer	P. V. Tsybin

Initiation of design studies	1957-58
Predraft plan signed	May 17 1959
Termination of studies	October 1 1959
Spacecraft	PKA/Lapotok
Launcher	8K72K/Vostok
Objective	Piloted military operations in Earth orbit with reusable spaceplane

6. M-48/VKA-23

Lead institutions	OKB-23 (spacecraft and launcher), OKB-1 (launcher)
General Designer	V. M. Myasishchev
Initiation of design studies	1957-58
TsK KPSS/SM approval	December 10, 1959
Project termination	October 3, 1960
Spacecraft	M-48
Launch vehicles	8K72K/Vostok, M-1
Objective	Piloted military operations in Earth orbit with reusable spaceplane

7. Sever/Space Station/IL Circumlunar Spacecraft

Lead institution	OKB-1
Chief Designer	S. P. Korolev
Initiation of studies	April 1959
Technical prospectus signed	March 10, 1962
Termination of studies	mid-1962
Spacecraft	5K/Sever 5KA & 5KB/space station 7K/Vostok 9K/rocket stage ILcircumlunar vehicle
Launch vehicle	8K711
Objectives	All-purpose Earth orbital operations with guided reentry, space station piloted circumlunar flight

8. Heavy Interplanetary Ship (TMK)

Lead institution	OKB-1
Chief Designers	S. P. Korolev, M. P. Mishin
Chief of Planning Department	M. K. Tikhonravov
Group Chiefs	G. Yu. Maksimov, K. P. Feoktistov
Initiation of studies	1959
Predraft plan signed	May 1966
Experimental design signed	1969
Termination of studies	1969
Spacecraft	MEK
Launch vehicle	N1, N1M
Objective	Piloted spacecraft for orbiting and landing on Mars

9. Raketoplan

Lead institutions	OKB-52 (spacecraft and launchers): OKB-586, OKB-1, and OKB-52 Branch No. 1 (launchers)
General Designer	V. N. Chelomey
Initiation of studies	1959
TsK KPSSISM approval	June 23, 1960
First launch attempt in program	December 22, 1961 (MP-1)
Draft plan signed	1963
Project termination	1965
Spacecraft	SR, MP-1, M-12, R-1, R-2
Launch vehicles	R-12, R-14, 8K81K, 8K82/Proton
Objective	Piloted reusable spaceplane for suborbital, orbital, and lunar missions

CHALLENGE TO APOLLO

APPENDIX A

10. Kosmoplan

Lead institutions	OKB-52 (spacecraft and launchers), OKB-1 and OKB-52 Branch No. 1 (launchers)
General Designer	V. N. Chelomey
Initiation of studies	1959
TsK KPSSISM approval	June 23, 1960
Predraft plan signed	1961
Project termination	May 22, 1964
Spacecraft	AK-1-7, AK-1-300, AK-3-300, AK-4
Launch vehicles	8K72K, A-300, 8K82/Proton
Objective	Automated and piloted reusable spacecraft to the Moon, Mars, and Venus

11. Soyuz Complex

Lead institutions	OKB-1 (7K and launcher), SKB-10 (11K), SKB-385 (9K)
Chief Designer	S. P. Korolev
Initiation of studies	January 26, 1962
Predraft plan signed	December 24, 1962
Technical prospectus signed	May 10, 1963
TsK KPSS/SM approval	December 3, 1963
Program termination	August 3, 1964
Spacecraft	7K/Soyuz-A, 9K/Soyuz-B, 11K/Soyuz-V
Launch vehicles	11A55, 11A56
Objective	Piloted circumlunar flight

12. R-56

Lead institution	OKB-586
Chief Designer	M. K. Yangel
TsK KPSSISM approval	April 16, 1962
Termination of studies	June 19, 1964
Launch vehicles	R-56, SK-100
Objectives	Robotic lunar landing, piloted circumlunar missions

13. Zvezda/Heavy Orbital Station (TOS)

Lead institution	OKB-1
Chief Designers	S. P. Korolev, V. P. Mishin
Initiation of design studies	1960
Predraft plan signed	May 3, 1961
Termination of studies	1969
Spacecraft	TOS/Zvezda
Launch vehicle	N1 derivatives
Objective	Large piloted space station in Earth orbit

14. Soyuz-R

Lead institution	OKB-1 Branch No. 3
Chief Designer	D. I. Kozlov
Initiation of studies	1962-63
MO approval	June 18, 1964
Predraft plan signed	July 15, 1965
Program termination (11F71 station)	Early 1966
Program termination (7K-TK ferry)	June 21, 1967
Spacecraft	7K-TK/11F72/Soyuz-R, 11F71 station
Launch vehicle	Soyuz-type
Objective	Piloted reconnaissance platform in Earth orbit

15. Soyuz-P

Lead institution	OKB-1 Branch No 3
Chief Designer	D. I. Kozlov
Initiation of studies	1962-63
Program termination	1965
Spacecraft	7K PPK/Soyuz-P
Launch vehicle	11A514
Objective	Piloted anti-satellite spacecraft in Earth orbit

16. NI-L3

Lead institution	OKB-1
Chief Designers	S. P. Korolev, V. P. Mishin, B. A. Dorofeyev
Deputy Chief Designers	K. D. Bushuyev, S. S. Kryukov, S. O. Okhapkin
Initiation of studies	March 1963
TsK KPSSISM approval	August 3, 1964
Predraft plan signed	December 30, 1964
Draft plan signed	November 11, 1965
First orbital launch attempt	February 21, 1969
Last orbital launch attempt	November 23, 1972
Project suspension	June 24, 1974
Program termination	February 18, 1976
Spacecraft	7K-LIS/11F92, 7K-LOK/11F93, LK/11F94, TIK, T2K, 7K-LIE Blok D (originally included L1, L2, L3, L4, and L5)
Launch vehicles	NI, NI derivatives, 8K82K/Proton-K
Objective	Landing of one cosmonaut on the Moon

17. Voskhod

Lead institutions	OKB-1 (spacecraft), OKB-1 Branch No 3 (launcher)
Chief Designers	S. P. Korolev, V. P. Mishin
Lead designer	Ye. A. Frolov
Initiation of studies	December 1963
VPK approval	March 13, 1964
TsK KPSS/SM approval	April 13, 1964
Draft plan signed	August 1964
First orbital launch attempt	October 6, 1964 (Kosmos-47)
Last orbital launch attempt	February 22, 1966 (Kosmos-110)
Program termination	September-October 1966
Spacecraft	3KV/11F63, 3KD/11F63
Launch vehicle	11A57/Voskhod
Objective	Propaganda goals in Earth orbit (multicrews, EVA, long duration, tethers)

18. UR-500K/LK-1

Lead institutions	OKB-52 (spacecraft), OKB-52 Branch No. 1 (launcher)
General Designer	V. N. Chelomey
Initiation of studies	Late 1963
Predraft plan signed	August 3, 1964
TsK KPSSISM approval	August 3, 1964
Draft plan signed	July 1965
Project termination	April 27, 1966
Spacecraft	LK-1, Blok A
Launch vehicle	8K82K/Proton-K
Objective	Piloted circumlunar flight

CHALLENGE TO APOLLO

APPENDIX A

19. UR-700/LK-700

Lead institutions	OKB-52 (spacecraft). OKB-52 Branch No. 1 (launch vehicle)
General Designer	V. N. Chelomey
Initiation of studies	1964
Approval for work on draft plan	October 20, 1965
Predraft plan signed	August–September 1966
Program suspended	November 1966
TsK KPSS/SM approval	September 17, 1967
LK-700 draft plan signed	October 1968
Project termination	Early 1969
Spacecraft	LK-700
Launch vehicle	UR-700
Objective	Direct ascent piloted lunar landing

20. Soyuz

Lead institutions	OKB-1 (spacecraft). OKB-1 Branch No. 3 (launcher)
Chief Designers	S. P. Korolev, V. P. Mishin, V. P. Glushko
Lead designers	Ye. A. Frolov, A. F. Topol, Yu. P. Semenov, Ye. P. Vyatkin, V. P. Guzenko
Initiation of studies	Late 1964
VPK approval	August 18, 1965
Draft plan signed	October 23, 1965
First orbital launch attempt	November 28, 1966 (Kosmos-133)
Last orbital launch attempt	May 14, 1981 (Soyuz 40)
Program termination	May 1981
Spacecraft	7K-OK/11F615, 7K-T/11F615A8, 7K-TA/11F615A9, 7K-TM/11F615A12
Launch vehicles	11A511/Soyuz, 11A511U/Soyuz-U
Objectives	Master rendezvous and docking techniques in Earth orbit, station ferry

21. Almaz Orbital Piloted Station (OPS)/Salyut

Lead institutions	OKB-52 (spacecraft). OKB-52 Branch No. 1 (launch vehicle)
General Designer	V. N. Chelomey
Lead designer	V. A. Polyachenko
Initiation of studies	October 1964
Draft plan signed	June 23, 1967
TsK KPSS/SM approval	August 14, 1967
First orbital launch attempt	April 3, 1973 (Salyut 2)
Last orbital launch attempt	June 22, 1976 (Salyut 5)
Project termination	December 19, 1981
Spacecraft	OPS/11F71 station, 7K-TK/11F72 ferry, 7K-TA/11F6159 ferry (see also TKS)
Launch vehicle	8K82K/Proton-K
Objective	Piloted military station in Earth orbit

22. N11-Soyuz

Lead institution	OKB-1
Chief Designer	S. P. Korolev
Initiation of studies	Late 1964
Technical prospectus signed	February 5, 1965
Termination of studies	August 1965
Spacecraft	7K-PLK
Launch vehicle	N11
Objective	Piloted lunar orbital flight

23. 7K-VI Zvezda

Lead institution	OKB-I Branch No. 3
Chief Designer	D. I. Kozlov
Initiation of studies	Late 1964
TsK KPSS/SM approval	August 24, 1965
Draft plan signed (first variant)	1965
Draft plan signed (second variant)	1967
MOM approval	July 7, 1966
Program termination	January-February 1968
Spacecraft	7K-VI/11F73/Zvezda
Launch vehicle	11A511M/Soyuz-M
Objective	Piloted military operations in Earth orbit

24. Spiral

Lead institutions	OKB-155 and Gromov LII (spaceplane), OKB-1 (conventional launcher), OKB-52 (booster). OKB-156 (GSR)
General Designer	A. I. Mikoyan
Chief Designer	G. Ye. Lozino-Lozinskiy
Initiation of studies	1964
Predraft plan signed	June 29, 1966
First launch attempt	July 15, 1969 (BOR-1)
Last launch attempt	1974 (BOR-3)
First airdrop	October 11, 1976 (105.11)
Last airdrop	September 1978 (105.11)
Project termination	September 1978
Spacecraft	Orbital Aircraft/50, EPOS, booster rocket. BOR-1, BOR-2, BOR-3, 105.11, 105.12, 105.13
Launch vehicle	GSR/50-50, 11A511/Soyuz, Tu-95K
Objective	Reusable military spaceplane for Earth-orbital operations

25. Zvezda Spaceplane

Lead institution	OKB 156
General Designer	A. N. Tupolev
Initiation of studies	Early 1960s
Termination of studies	1966
Spacecraft	Zvezda
Launch vehicle	Tu-95K
Objective	Air-launched reusable military spaceplane

26. Zond

Lead institutions	OKB-1 (spacecraft and upper stage), OKB-52 Branch No. 1 (launcher)
Chief Designers	S. P. Korolev, V. P. Mishin
Lead designers	B. V. Rublev, Yu. P. Semenov
Initiation of studies	August 1965
TsK KPSSISM approval	October 25, 1965
MOM approval	November 13, 1965
Predraft plan signed	November 30, 1965
First orbital launch attempt	March 10, 1967 (Kosmos-146)
Last orbital launch attempt	October 20, 1970 (Zond 8)
Program termination	October 1970
Spacecraft	7K-L111F91/Zond, 7K-OK-TISoyuz
Launch vehicle	8K82K/Proton-K
Objective	Piloted circumlunar flight

APPENDIX A

27. Multirole Orbital Complex (MOK)

Lead institution	TsKBEM
Chief Designers	S. P. Korolev, V. P. Mishin
Initiation of studies	September 30, 1963
VPK decree on issue of technical plan	February 23, 1972
Draft plan signed	Early 1973
Program termination	May 1974
Spacecraft	MBKS. 19K modules. TKS
Launch vehicles	NI. NI derivatives
Objective	Massive piloted complex in Earth orbit

28. Long-Duration Lunar Base (DLB)

Lead institutions	KB OM (spacecraft), GSMZ Lavochkin (spacecraft). TsKBEM (spacecraft and launcher)
Chief Designers	V. P. Barrnin. V. P. Mishin
Initiation of studies	1965-66
Termination of studies	Late 1970s
Spacecraft	Bolshoye koltso. Kolumb. Dal. Osvoyeniye
Launch vehicles	NI. NI derivatives
Objective	Permanent piloted base on lunar surface

29. Transport-Supply Ship (TKS)

Lead institutions	OKB-52 and OKB-52 Branch No. 1 (spacecraft). OKB-52 Branch No. 1 (launcher)
Initiation of studies	1966-67
Draft plan signed	1969
First orbital launch attempt/TKS	July 17, 1977 (Kosmos-929)
Last orbital launch attempt/TKS	September 27, 1985 (Kosmos-1686)
First orbital launch attempt/TKS VA	December 15, 1976
Last orbital launch attempt/TKS VA	May 23, 1979 (Kosmos-1 1001101)
Project termination	1986
Spacecraft	TKS/11F72, TKS VA/11F74, TKS FGB/11F77
Launch vehicle	8K82K/Proton-K
Objective	Transport ship for Almaz and Salyut space stations

30. Soyuz-VI

Lead institutions	TsKBEM and TsKBEM Branch No. 3 (spacecraft), TsKBEM Branch No. 3 (launcher)
Chief Designers	V. P. Mishin, D. I. Kozlov
Initiation of studies	Late 1967
Project approval	January-February 1968
Draft plan signed	June 23, 1968
Project termination	February 1970
Spacecraft	OB-VI station/11F731, 7K-S/11F732, 7K-S-II/11F733, 7K-S-III/11F734, 7K-G/11F735
Launch vehicle	11A511/Soyuz
Objectives	Small military space station in Earth orbit with different ferry craft

31. UR-700M/MK-700

Lead institutions	TsKBM (spacecraft), TsKBM Branch No. 1 (launcher)
General Designer	V. N. Chelomey
Initiation of studies	Early 1969
MOM approval	June 30, 1969
Predraft plan signed (MK-700)	April 1970

Predraft plan signed (UR-700M)	October 1970
Project termination	Late 1970
Spacecraft	MK-700
Launch vehicle	UR-700M
Objective	Piloted landing on Mars

32. Long-Duration Orbital Station (DOS)/Salyut

Lead institutions	TsKBEM and TsKBM Branch No. 1 (spacecraft), TsKBM Branch No. 1 (launcher)
Chief/General Designers	V. P. Mishin, V. P. Glushko, Yu. P. Semenov, V. N. Bugayskiy
Lead designer	Yu. P. Semenov, V. V. Pallo
Initiation of studies	December 1969
TsK KPS/SM approval	February 9, 1970
First orbital launch attempt	April 19, 1971 (<i>Salyut</i>)
Last orbital launch attempt	February 19, 1986 (<i>Mir</i>)
Project termination	—
Spacecraft	17K/DOS, 17KS/ <i>Mir</i> , 17KSM/ISS
Launch vehicle	8K82K/Proton-K
Objective	Small piloted station in Earth orbit with ferry craft

33. NI-L3M

Lead institution	TsKBEM
Chief Designers	V. P. Mishin, V. A. Borisov
Initiation of studies	1969–70
Draft plan signed	Late 1971
Approval by Council of Chief Designers	May 15, 1972
Project termination	May 1974
Spacecraft	L3M
Launch vehicle	NIF
Objective	Long-duration piloted landings on the Moon

APPENDIX B

Appendix B Dramatis Personae. 1945-74

Full Name	Date of Birth/Death	Contribution to the Soviet Space Program
<i>Designers and Scientists</i>		
Abramov , Anatoliy Petrovich	1919–August 15, 1998	Deputy Chief Designer in 1966–80 at OKB Korolev worked on launch complexes
Alekseyev , Semyon Mikhaylovich	1909–	Chief Designer in 1952–73 at OKB Zvezda worked on spacesuits and airlocks
Avduyevskiy , Vsevolod Sergeyevich	July 28, 1920–	Scientist at NII-1 in 1953–73 and First Deputy Director at TsNIIIMash in 1973–87
Babakin , Georgiy Nikolayevich	November 14, 1914– August 3, 1971	Chief Designer in 1965–71 at OKB Lavochkin led work on lunar and interplanetary spacecraft
Barmin , Vladimir Pavlovich	March 17, 1909– July 17, 1993	Chief Designer in 1941–93 at CSKB SpetsMash designed launch complexes
Blagonravov , Anatoliy Arkadyevich	June 1, 1894– February 4, 1975	President of the Academy of Artillery Sciences in 1946–50 and public spokesperson
Blokhin , Yuriy Dmitriyevich	Unknown	Head of Mikoyan KB space branch worked on the Spiral spaceplane.
Bogomolov , Aleksey Fedorovich	June 2, 1913	Chief Designer in 1954–88 at OKB MEI worked on telemetry and guidance systems
Bogomolov , Vladislav Nikolayevich	September 14, 1919– February 9, 1997	Chief Designer in 1971–85 at OKB Isayev worked on rocket engines and succeeded Isayev
Boguslavskiy , Yevgeniy Yakovlevich	1917–May 18, 1969	Deputy Chief Designer in 1950–69 at Ryazanskiy NII worked on spacecraft guidance systems
Bolkhovitinov , Viktor Fedorovich	1989–1970	At NII-1, he worked on the Sänger-Bredt antipodal bomber
Bondaryuk , Mikhail Makarovich	1908–1969	Chief Designer in 1950–69 at OKB-670 worked on ramjet engines for Burya and Buran
Borodin , Sergey Aleksandrovich	1935–	Chief Designer from 1975 on at SOKB of Gromov LII designed simulators and cockpit consoles
Budnik , Vasilii Sergeyevich	June 24, 1913–	Deputy Chief Designer in 1954–72 at OKB Yangel worked on missiles and was a Korolev protege
Bugayskiy , Viktor Nikifirovich	Unknown	He headed OKB Chelomey Branch No. 1 in 1960–73 and worked on rockets and spacecraft
Bushuyev , Konstantin Davidovich	May 23, 1914– October 26, 1978	Deputy Chief Designer in 1954–72 at OKB Korolev led piloted spacecraft projects

Full Name	Date of Birth/Death	Contribution to the Soviet Space Program
Bykov , Yuriy Sergeyevich	1916-1970	Chief Designer in 1959-70 at NII-695 worked on communications systems for piloted spacecraft.
Chelomey , Vladimir Nikolayevich	June 30, 1914- December 8, 1984	Chief Designer/General Designer in 1955-84 at OKB-52 led work on cruise missiles, ICBMs, and spacecraft
Chertok , Boris Yevseyevich	March 1, 1912-	Deputy Chief Designer in 1956-91 at OKB Korolev worked on guidance systems
Darevskiy , Sergey Grigoryevich	Unknown	Chief Designer in 1965-75 at SOKB of Gromov LII designed simulators and cockpit consoles
Dorofeyev , Boris Arkadyevich	November 25, 1927- July 9, 1999	Deputy Chief Designer at OKB Korolev, was Chief Designer for N1 rocket in 1972-74 (demoted in 1974)
Eidis , Arkadiy Ionovich	1913-	He headed OKB Chelomey Branch No. 3 in 1962-65 and was later Chelomey's First Deputy General Designer.
Foektistov , Konstantin Petrovich	February 7, 1926	Department Chief at OKB Korolev worked on Vostok and other piloted spacecraft
Gazenko , Oleg Georgiyevich	December 12, 1918-	Director of IMBP in 1969-88 performed early work on space medicine
Glushko , Valentin Petrovich	September 2, 1908- January 10, 1989	Chief Designer/General Designer in 1946-89 at OKB-456 designed rocket engines for missiles and launchers
Gubanov , Boris Ivanovich	March 14, 1930- March 18, 1999	He was First Deputy Chief Designer/General Designer in 1972-82 at OKB Yangel and in 1982-93 at OKB Korolev
Gubenko , Yevgeniy Stepanovich	Unknown-1959	Chief Designer in 1950-59 at SKB-567 worked on ground communications segment
Gusev , Leonid Ivanovich	1922	Director of NII-695 and from 1965 on Director of NII-695 led work on guidance systems.
Iosifyan , Andronik Gevondovich	1905-1993	Chief Designer in 1941-74 at NII-627 worked on power sources and remote-sensing craft
Isayev , Aleksey Mikhailovich	October 24, 1908- June 10, 1971	Chief Designer in 1947-71 at OKB-2 led work on engines for piloted spacecraft
Ishlinskiy , Aleksandr Yulevich	August 6, 1913-	Director of Institute of Mechanics in 1964-89 prepared space communications
Ivanov , Ivan Ivanovich	1918	Deputy Chief Designer at OKB Yangel led work on LK lander engine.
Ivanovskiy , Oleg Genrikhovich	January 18, 1922-	He worked at OKB-1 on Sputnik and Vostok and was Deputy Chief Designer in 1971-83 at OKB Lavochkin

CHALLENGE TO APOLLO

APPENDIX B

Full Name	Date of Birth/Death	Contribution to the Soviet Space Program
Ivensen , Pavel Albertovich	1908-	At OKB-52, he worked on the early development of Proton and <i>Salyut</i>
Izotov , Sergey Petrovich	June 30, 1917- May 6, 1983	Chief Designer/General Designer in 1960-83 at OKB-117 worked on Chelomey's lunar lander engines
Kartukov , Ivan Ivanovich	Unknown	Chief Designer of KB-2 at Plant No. 81 worked on solid-propellant engines for spacecraft
Keldysh , Mstislav Vsevolodovich	February 10, 1911- June 24, 1978	Director of NII-1 in 1946-55. Chief of IPM in 1953-78, and President of Academy of Sciences in 1961-75 led scientific work on missiles/spacecraft
Kemurdzhian , Aleksandr Leonovich	Unknown	Chief Designer at VNII-100 worked on robotic lunar rovers.
Khomyakov , Mikhail Stepanovich	Unknown	At OKB-1, he was lead designer for Sputnik. later he was Deputy General Designer at NPO Energiya
Khristianovich , Sergey Aleksandrovich	November 9, 1908	He worked on ICBMs at TsAGI in 1942-53 and then at Institute of Theoretical and Applied Mechanics
Khrushchev , Sergey Nikitich	1934-	Deputy Department Chief in 1958-68 at OKB Chelomey is son of Nikita Khrushchev
Kisunko , Grigoriy Vasilyevich	July 20, 1918-1998	Chief Designer/General Designer in 1953-75 at KB-1 and later at OKB-30 led work on early anti-ballistic missile/ASAT
Konopatov , Aleksandr Dmitriyevich	March 10, 1922-	Chief Designer in 1965-93 at OKB Kosberg led work on rocket engines
Konoplev , Boris Mikhaylovich	1912-October 24, 1960	He worked on guidance at NII-885, NII-695, and OKB-692 and died in the R-16 accident
Korolev , Sergey Pavlovich	January 12, 1907- January 14, 1966	Chief Designer in 1946 at OKB-1 and founder of the Soviet space program, his early prewar rocketry work was at GIRD and NII-3
Kosberg , Semyon Ariyevich	December 14, 1903- January 3, 1965	Chief Designer in 1941-65 at OKB-154 led work on engines for ICBMs and launchers
Kotelnikov , Vladimir Aleksandrovich	September 6, 1908-	He was at OKB MEI in 1947-54 and then at the Institute of Radio Technology and Electronics
Kovtunen , Vyecheslav Mikhaylovich	August 31, 1921- July 10, 1995	With early work at OKB Yangel, he later was Chief Designer/General Designer at NPO Lavochkin in 1977-95
Kozlov , Dmitriy Ilich	October 1, 1919-	As head of OKB Korolev Branch No. 3/TsSKB from 1959 on, he worked on reconnaissance satellites
Kryukov , Sergey Sergeyevich	1918-	He was Deputy Chief Designer in 1961-65 at OKB Korolev then Chief Designer in 1971-77 at OKB Lavochkin

Full Name	Date of Birth/Death	Contribution to the Soviet Space Program
Kurchatov , Igor Vasilyevich	January 12, 1903- February 7, 1960	At KB-11, he worked on first hydrogen bomb-work coordinated with OKB-1
Kuznetsov , Nikolay Dmitriyevich	June 23, 1911- July 30, 1995	Chief Designer/General Designer in 1949-94 at OKB-276 worked on rocket engines for the NI and GR-1
Kuznetsov , Viktor Ivanovich	April 27, 1913- March 22, 1991	Chief Designer in 1946-89 at NII 10 and Nil-944 worked on missile and spaceship gyros
Lapugin , Vladimir Lavrentyevich	February 4, 1925-	Deputy Chief Designer at Pilyugin NII worked on guidance and succeeded Pilyugin in 1982
Lavochkin , Semyon Alekseyevich	September 11, 1900- June 9, 1960	Chief Designer in 1939-60 at OKB-301 worked on Burya cruise missile
Lebedinskiy , Andrey Vladimirovich	1902-January 3, 1965	He was first Director of IMBP in 1963-65 and an early space medicine pioneer
Lidorenko , Nikolay Stepanovich	April 15, 1916	Chief Designer at NII IT worked on power sources for spacecraft including Sputnik
Likhushin , Valentin Yakovlevich	May 29, 1918- December 4, 1982	Director of NII-1 in 1955-88 worked on advanced engines
Lobanov , Nikolay Aleksandrovich	1909-1978	Chief Designer in 1968-77 at NII PDS worked on parachutes and succeeded Tkachev
Lozino-Lozinskiy , Gleb Yevgenyevich	December 25, 1909-	Chief Designer in 1966-76 at OKB Mikoyan led work on the Spiral spaceplane
Lyulka , Arkhip Mikhaylovich	March 23, 1908- June 2, 1984	Chief Designer/General Designer in 1946-84 at OKB-165 worked on cryogenic engines for the NI
Makeyev , Viktor Petrovich	October 25, 1924- October 25, 1985	This Chief Designer/General Designer in 1955-85 at SKB-385 was a Korolev protege
Melnikov , Mikhail Vasilyevich	September 22, 1919- 1996	Deputy Chief Designer in 1960-74 at OKB Korolev worked on engines including Blok D
Mikoyan , Artem Ivanovich	August 5, 1905- December 9, 1970	Chief Designer/General Designer in 1942-69 at OKB-155 led work on the Spiral spaceplane system
Mishin , Vasily Pavlovich	January 18, 1917-	Chief Designer in 1966-74 at OKB Korolev led work on the NI-L3 lunar program was fired in 1974 and was later at MAI
Mnatsakanyan , Armen Sergeyevich	November 7, 1918-1992	Chief Designer in 1953-69 at NII-648 worked on spacecraft telemetry and radar systems
Myasishchev , Vladimir Mikhaylovich	September 28, 1902- October 14, 1978	Chief Designer in 1951-60 at OKB-23 worked on a spaceplane and was later Director of TsAGI
Nesmeyanov , Aleksandr Nikolayevich	September 9, 1899-1980	President of the Academy of Sciences in 1951-61 approved the first satellite project

CHALLENGE TO APOLLO

APPENDIX B

Full Name	Date of Birth/Death	Contribution to the Soviet Space Program
Nudelman , Aleksandr Emmanuilovich	1912–August 2, 1996	Chief Designer in 1965–87 at OKB-16 worked on a space cannon for Chelomey and Kozlov
Okhapkin , Sergey Osipovich	1910–March 1980	Deputy Chief Designer in 1952–76 at OKB Korolev led work on the N1 and was Mishin's First Deputy
Okhotsimskiy , Dmitriy Yevgenyevich	February 26, 1921–	This scientist at OPM MIAN did research work on an early ICBM.
Pallo , Vladimir Vladimirovich	Unknown	Deputy Chief Designer at OKB Chelomey Branch No. 1 led work on the DOS and <i>Salyut</i> stations.
Parin , Vasily Vasilyevich	March 18, 1903– June 15, 1971	Director of IMBP in 1965–69 was a premier space medicine specialist
Paton , Boris Yevgenyevich	November 27, 1918–	Director of Institute of Electrical Welding from 1953 on worked on the N1 and the Vulkan unit
Petrov , Boris Nikolayevich	March 11, 1913– August 23, 1980	Department Chief in 1951–1980 at Institute of Control Problems was a public spokesperson
Petrov , Georgiy Ivanovich	May 31, 1912 May 17, 1987	After conducting aerodynamic research at NII-1 he was Director of Institute of Space Research in 1965–73
Pilyugin , Nikolay Alekseyevich	May 18, 1908– August 2, 1982	Chief Designer in 1948–82 at NII 885 and NII AP worked on missile and spaceship guidance
Pobedonostsev , Yuriy Aleksandrovich	February 7, 1907– October 1973	He was Chief Engineer in 1946–49 at NII-88 and was later at NII-125
Polukhin , Dmitriy Alekseyevich	March 12, 1927– September 7, 1993	Chief Designer in 1973–93 at OKB Chelomey Branch No. 1 led the development of Proton.
Radovskiy , Viktor Petrovich	May 11, 1920–	Deputy Chief Designer at OKB-456 worked on rocket engines and succeeded Glushko in 1989
Raspletin , Aleksandr Andreyevich	August 25, 1908–1967	Chief Designer in 1953–67 at KB-1 worked on the RORSAT, EORSAT, and ASAT programs
Raushenbakh , Boris Vtkorovich	January 18, 1915–	Department Chief in 1960–73 at OKB Korolev worked on guidance systems
Reshetnev , Mikhail Fedorovich	November 10, 1924– January 26, 1996	Chief Designer/General Designer in 1961–96 at OKB-10 led work on communications satellites and was a Korolev protege
Rosselevich , Igor Aleksandrovich	1918–1991	Chief Designer in 1954–83 at NII-380 worked on TV systems for spacecraft
Ryazanskiy , Mikhail Sergeevich	April 5, 1909– August 7, 1987	Chief Designer in 1946–51 and 1955–87 at NII-885 worked on missile and spacecraft radio guidance.
Savin , Anatoliy Ivanovich	April 6, 1920–	General Designer from 1962 on at KB-1 and TsNII Kometa worked on the RORSAT, EORSAT, and ASAT programs

Full Name	Date of Birth/Death	Contribution to the Soviet Space Program
Semenov , Yuriy Pavlovich	April 20. 1935-	He was the lead designer of Soyuz and Zond at OKB Korolev and then General Designer at RKK Energiya from 1989 on
Sedov , Leonid Ivanovich	November 14. 1907-	He chaired the Commission for Promotion of Interplanetary Flights and was a public spokesperson.
Severin , Gay Ilich	July 24. 1926-	Chief Designer/General Designer from 1964 on at OKB Zvezda worked on spacesuits and EVA airlocks
Shabarov , Yevgenty Vasilyevich	1922-	Deputy Chief Designer at OKB Korolev led the flight testing of piloted spacecraft.
Sheremetyevskiy , Nikolay Nikolayevich	November 5. 1916-	Chief Designer in 1974-91 at NII Iosifyan in 1974-91 worked on power sources and Earth survey satellites
Sisakyan , Norair Martirosovich	January 25, 1907-March 10. 1966	At the Second Division of Biological Sciences under the Academy of Sciences, he was an early medicine specialist
Solovyev , Vsevolod Nikolayevich	Unknown	Chief Designer in 1963-92 at KB TransMash designed space launch complexes
Stechkin , Boris Sergeyeovich	1891-April 2. 1969	Chief Designer in 1955-69 at OKB Fakel under the Academy of Sciences performed attitude control engine work
Stroyev , Nikolay Sergeyeovich	1912-1997	Director of Gromov LII in 1954-66 worked on spacecraft testing and later was at VPK
Struminskiy , Vladimir Vasilyevich	April 29. 1914-	Director of Institute of Theoretical and Applied Mechanics in 1966-71 worked on liquid hydrogen.
Tikhonravov , Mikhail Klavdiyevich	July 29. 1900-March 4. 1974	Designer at NII-4 and OKB Korolev worked on Sputnik and Vostok and performed early ICBM work and early work at GIRD and NII-3.
Tkachev , Fedor Dmitriyevich	Unknown	Chief Designer at NII PDS worked on parachutes and was fired in 1968 after Soyuz 1
Tregub , Yakov Isayevich	Unknown	Deputy Chief Designer in 1964-73 at OKB Korolev led flight control for piloted flights
Tritko , Karl Ivanovtch	Unknown	Chief of SKB at NII-88 in 1946-49 led work on early missiles
Trufanov , Yuriy Nikolayevich	Unknown	He was Deputy Chief Designer at OKB Chelomey Branch No 1 and was then at NPO Energiya and NPO Lavochkin
Tsybin , Pavel Vladimirovich	December 23. 1905-February 4. 1992	Deputy Chief Designer in 1960s at OKB Korolev performed early spaceplane work at OKB-256
Tumanskiy , Sergey Konstantinovich	May 21. 1901-September 9. 1973	Chief Designer/General Designer in 1955-73 at OKB-300 worked on spacecraft attitude engines

CHALLENGE TO APOLLO

APPENDIX B

Full Name	Date of Birth/Death	Contribution to the Soviet Space Program
Tupolev , Andrey Nikolayevich	November 10, 1888– December 23, 1972	Chief Designer/General Designer in 1943–72 at OKB-156 worked on spaceplane carrier aircraft
Tyurin , Petr Aleksandrovich	June 25, 1917– February 26, 2000	Chief Designer in 1953–81 of KB Arsenal worked on L3 components and later performed EORSAT work.
Utkin , Ivan Ivanovich	April 23, 1910– August 29, 1985	Chief Designer in 1960–70 at NII IT worked on spacecraft memory data recorders.
Utkin , Vladimir Fedorovich	October 17, 1923– February 15, 2000	He was Deputy Chief Designer in 1961–71 at OKB Yangel and succeeded Yangel in 1971
Vernov , Sergey Nikolayevich	July 11, 1910– September 26, 1982	Director of NII-YaF of Moscow State University in 1960–82 worked on science experiments
Vinogradov , Aleksandr Pavlovich	August 21, 1895–1975	Director of Institute of Geochemical and Analytical Chemistry worked on lunar samples
Vitka , Vladimir Andreyevich	November 19, 1901– January 10, 1989	First Deputy Chief Designer in 1954–61 at OKB Clushko worked on rocket engines
Voronin , Grigoriy Ivanovich	December 21, 1906– 1987	Chief Designer in 1939–85 at OKB-124 worked on life support systems for spacecraft
Voskresenskiy , Leonid Aleksandrovich	July 14, 1913– December 15, 1965	Deputy Chief Designer in 1953–64 at OKB Korolev led flight testing of missiles.
Yangel , Mikhail Kuzmich	October 25, 1911– October 25, 1971	Chief Designer in 1954–71 at OKB-586 led work on missiles and robotic spacecraft.
Yefremov , Serbert Aleksandrovich	March 15, 1933–	Deputy General Designer in 1971–84 at OKB Chelomey succeeded Chelomey in 1984
Zaslavskiy , Mark Efimovich	1920–1995	He was Chief Designer in the 1960s at TsNII-108.
<i>Military Officers</i>		
Agadzhanov , Pavel Artemyevich	May 21, 1923–	Department Chief in 1957–71 at TsKIK led flight control for piloted missions.
Agaltsov , Fillip Aleksandrovich	January 8, 1900–1980	Air Force Deputy Commander-in-Chief in 1958–62 prepared the selection of cosmonauts.
Alekseyev , Nikolay Nikolayevich	1914–November 12 1980	He chaired the Science and Technical Committee, General Staff, Ministry of Defense, in 1960–70
Anokhin , Sergey Nikolayevich	March 19, 1910– April 15, 1986	He was a test pilot for Cromov LII in 1941–64 and then worked at OKB Korolev
Babychuk , Aleksandr Nikolayevich	Unknown	Chief, Biomedical Service at Air Force oversaw the early Vostok missions
Beregovoy , Georgiy Timofeyevich	April 15, 1921– June 30, 1995	He was a cosmonaut who later became Director of the Cosmonaut Training Center in 1972–86
Bibikov , Yakov Lvovich	Unknown	He was Director of NII-1 during German recovery operations in 1945–46

Full Name	Date of Birth/Death	Contribution to the Soviet Space Program
Biryuzov , Sergey Semenovich	August 21, 1904– October 19, 1964	He was Commander-in-Chief of RVSN in 1962–63 and later Chief of General Staff Ministry of Defense
Bolsшой , Amos Aleksandrovich	Unknown	Department Chief at TsKIK led flight control teams for early missions
Bulychev , Ivan Timofeyevich	Unknown	He was Chief of Communications Directorate Ministry of Defense in 1956–58
Chechulin , Petr Petrovich	September 10, 1906– September 16, 1971	He was Director of NII-4 in 1951–55 during early research on satellites
Fedorov , Petr Ivanovich	1898–February 7, 1945	First Director of NII I in 1944–45 oversaw the early search for the A-4
Gagarin , Yuriy Alekseyevich	March 9, 1934– March 27, 1968	First human in space later became Deputy Director of the Cosmonaut Training Center in 1963–67 and then died in a plane crash
Gallay , Mark Lazarevich	1914–1998	Test pilot at Gromov LII led training at the Cosmonaut Training Center
Caydukov , Lev Mikhaylovich	January 14, 1911–	Chief of the Interdepartmental Technical Commission in Germany in 1945–46
Genin , Abram Moiseyevich	May 12, 1922	He was Directorate Chief at Institute of Aviation and Space Medicine in 1964–75
Gerchik , Konstantin Vasilyevich	September 27, 1918–	He was Commander of Tyura-Tam during the R-16 disaster in 1958–61
Goreglyad , Leonid Ivanovich	1915–1986	He was General Staff representative at the Cosmonaut Training Center and an aide to Kamanin
Grechko , Andrey Antonovich	October 17, 1903– April 26, 1976	Deputy Minister of Defense in 1967–76 was against piloted space programs
Grigoryev , Mikhail Grigoryevich	October 23, 1917– November 12, 1981	First Commander of Mirnyy site in 1957–62 later chaired the State Commission for Almaz
Curovskiy , Nikolay Nikolayevich	Unknown	He was a doctor at Institute of Aviation and Space Medicine and later Deputy Director at IMBP
Kamanin , Nikolay Petrovich	1909–March 13, 1982	Deputy Chief of General Staff in 1958–66 and then Aide to Air Force Commander in 1966–71 oversaw cosmonaut training
Karas , Andrey Grigoryevich	September 27, 1918 January 2, 1979	He was Chief of TsKIK in 1959–65 and later Commander of TsUKOS/GUKOS in 1965–79
Karpov , Yevgeniy Anatolyevich	1921–May 1990	He was first Director of the Cosmonaut Training Center in 1960–63
Kerimov , Kerim Aliyevich	November 14, 1917	First Commander of TsUKOS in 1964–65 and Directorate Chief at Ministry of General Machine Building in 1965–74 chaired the State Commission for Soyuz in 1966–91

CHALLENGE TO APOLLO

APPENDIX B

Full Name	Date of Birth/Death	Contribution to the Soviet Space Program
Kirillov , Anatoliy Semenovich	December 31, 1924– March 30, 1987	Chief First Directorate, at Tyura Tam in 1960–67 oversaw launch teams
Krylov , Nikolay Ivanovich	April 29, 1903– February 9, 1972	Commander-in-Chief, Strategic Missile Forces. in 1963–72 was against piloted space programs
Kurushin , Aleksandr Aleksandrovich	March 14, 1922	He was Commander of Tyura-Tam in 1965–73 during the NI launches.
Kutakhov , Pavel Stepanovich	August 6, 1914–	Commander-in Chief of Air Force in 1969–84 succeeded Vershinin
Kuznetsov , Nikolay Fedorovich	December 26, 1916– March 5, 2000	He was Commander of the Cosmonaut Training Center in 1963–72 during the Voskhod and Soyuz programs
Kuznetsov , Nikolay Nikolayevich	1903–1983	He was first Chief of the Interdepartmental Technical Commission in Germany in 1945
Maksimov , Aleksandr Aleksandrovich	August 29, 1923– October 12, 1990	Deputy Chief of TsKIK was later Commander of GUKOS/UNKS in 1979–89
Malinovskiy , Rodion Yakovlevich	November 23, 1898– March 31, 1967	Minister of Defense in 1957–67 was against piloted space programs
Morozov , Viktor Pavlovich	November 1, 1918– July 4, 1981	He chaired the <i>Scientific-Technical</i> Committee of the Strategic Missile Forces in 1962–67.
Moskalenko , Kirill Semenovich	May 11, 1902–June 17, 1985	He was Commander-in-Chief of the Strategic Missile Forces in 1960–62 and succeeded Nedelin
Mozzhorin , Yuriy Aleksandrovich	December 28, 1920– May 15, 1998	Director of NII-88 in 1961–90 oversaw Soviet space policy
Mrykin , Aleksandr Grigoryevich	August 15, 1905– October 6, 1972	He was First Deputy Commander of GURVO in 1955–65 and Strategic Missile Forces liaison with space
Nedelin , Mitrofan Ivanovich	November 9, 1902– October 24, 1960	Deputy Minister of Defense in 1955–59 was first Commander-in Chief of the Strategic Missile Forces and died in the R-16 accident
Nesterenko , Aleksey Ivanovich	March 30, 1908– July 18, 1995	He was first Director of NII-4 in 1946–50 and then first Commander of Tyura-Tam in 1955–58
Nitochkin , Aleksey Alekseyevich	Unknown	Engineer at TsPI-31 designed Tyura-Tam launch range
Nosov , Aleksandr Ivanovich	March 27, 1913– October 24, 1960	Chief of launch command at Tyura Tam in 1955–58 died in the R-16 disaster
Odintsov , Mikhail Petrovich	1921–	Director of the Cosmonaut Training Center in 1963 was fired
Ostashev , Yevgeniy Ilich	March 22, 1924– October 24, 1960	First Directorate Chief at Tyura-Tam in 1956–60 died in the R-16 disaster

Full Name	Date of Birth/Death	Contribution to the Soviet Space Program
Pokrovskiy , Aleksey Vasilyevich	1903-1988	He was Director of Institute of Aviation and Space Medicine from the 1940s to 1959.
Rudenko , Sergey Ignatyevich	October 7, 1904-1990	First Deputy Commander-in-Chief of Air Force in 1958-68 oversaw cosmonaut training
Semenov , Anatoliy Ivanovich	November 12 1908- April 16 1973	He was Commander of CURVO during Sputnik and Vostok in 1954-64.
Shatalov , Vladimir Aleksandrovich	December 18. 1927-	Commander-in-Chief's Aide of Air Force in 1971-87 succeeded Kamanin.
Shubnikov , Georgiy Maksimovich	May 1. 1903-July 31 1965	He was Chief of Construction Directorate at Tyura-Tam in 1955-65.
Smirnitskiy , Nikolay Nikolayevich	August 9, 1918- April 15. 1993	Commander of CURVO in 1967-75 later moved to Ministry of General Machine Building
Sokolov , Andrey Illarionovich	October 30. 1910- February 5. 1976	He was Director of Nil-4 during the early space program in 1955-70
Spiridinov , Aleksey Sergeyevich	Unknown	He was in Seventh Chief Directorate of Ministry of Armaments and Director of NII-88 in 1953-59
Spitsa , Ivan Ivanovich	1919-1992	He was Commander of TsKIK during the NI launches in 1965-73.
Titov , German Stepanovich	September 11. 1935-	Second human in orbit was later First Deputy Commander of GUKOS in 1979-91
Tolubko , Vladimir Fedorovich	November 25. 1914- June 17. 1989	First Deputy Commander-in-Chief of the Strategic Missile Forces in 1960-68 was later Commander-in-Chief in 1972-85
Tveretskiy , Aleksandr Fedorovich	November 17. 1904- December 31. 1992	He was first Commander of Special Purpose Brigade precursor to the Strategic Missile Forces, in 1946-49
Tyulin , Georgiy Aleksandrovich	October 9. 1914- April 22. 1990	First Deputy Chairman of GKOT in 1961-65 and First Deputy Minister of General Machine Building in 1965-76 oversaw many State Commissions
Vasilyev , Anatoliy Aiekesevich	November 28. 1921- November 12. 1973	Commander of CURVO in 1964-67 later chaired the Scientific-Technical Committee of the Strategic Missile Forces in 1967-69
Vershinin , Konstantin Andreyevich	June 3. 1900- December 30. 1973	He was Commander of Air Force during the Vostok Voskhod and early Soyuz missions in 1957-69
Vitruk , Andrey Avksentyevich	1906-	He was first Commander of TsKIK during the Sputnik and Luna missions in 1957-59
Volynkin , Yuvenaliy Mikhaylovich	February 7. 1907	He was Director of Institute of Aviation and Space Medicine in 1960-69 during Vostok.
Voronov , Nikolay Nikolayevich	1899-February 28 1968	Commander of Artillery Forces in 1941-1950 later became President of Academy of Artillery Sciences

CHALLENGE TO APOLLO

APPENDIX B

Full Name	Date of Birth/Death	Contribution to the Soviet Space Program
Votintsev , Yuriy Vsevolodovich	1919-	First Commander of PRO/PKO forces in 1967-85 was in charge of ASAT forces
Voznyuk , Vasily Ivanovich	January 1, 1907- September 12, 1976	First Commander of Kapustin Yar range in 1946-73 selected the Tyura-Tam site
Yakovlev , Nikolay Dmitriyevich	1898-May 10, 1972	He was Chief of Chief Artillery Directorate in 1941-48.
Yazdovskiy , Vladimir Ivanovich	1913-	Deputy Director of Institute of Aviation and Space Medicine was a space medicine pioneer.
Zakharov , Aleksandr Grigoryevich	February 20, 1921-	He was Commander of Tyura-Tam range during Vostok and Voskhod in 1961-65.
Zakharov , Matvey Vasilyevich	1898-January 31, 1972	He was Chief of Ministry of Defense General Staff in 1960-73.
Zhukov , Georgiy Konstantinovich	December 1, 1896- June 18, 1974	He was Minister of Defense in 1955-57 during the selection of Tyura-Tam
<i>Party and Government Officials</i>		
Afanasyev , Sergey Aleksandrovich	August 30, 1918-	First Minister of General Machine Building in 1965-83 oversaw N1 project
Balmont , Boris Vladimirovich	October 6, 1927-	He was Chief of Chief Directorate at Ministry of General Machine Building in 1965-73 and First Deputy Minister of General Machine Building in 1976-81
Beriya , Lavrentiy Pavlovich	March 29, 1899- December 23, 1953	He was Soviet security apparatus chief through 1953
Brezhnev , Leonid Illich	December 19, 1912- November 10, 1982	He was Secretary of Central Committee for defense and space in 1957-60 and 1963-65.
Brezhnev , Mikhail Aleksandrovich	Unknown	Deputy Minister of General Machine Building was responsible for guidance systems
Bulganin , Nikolay Aleksandrovich	June 11, 1895- February 24, 1975	Minister of Defense in 1947-49 and 1953-55 chaired Special Committee No. 2 in 1947-49.
Burnazyan , Avetik Ignatyevich	1906-	Deputy Minister of Health from 1947 was involved in Voskhod crew selection
Butoma , Boris Yevstafiyevich	May 1, 1907-July 11 1976	He was Minister of Ship Building Industry in 1957-76
Dementyev , Petr Vasilyevich	January 24, 1907- May 14, 1977	Minister of Aviation Industry in 1953-77 was a supporter of Chelomey
Dmitryev , Igor Fedorovich	1909-	First Deputy Chief, Central Committee Defense Industries Department in 1965-81 succeeded Serbin
Domrachev , Aleksandr Vasilyevich	October 1906- January 26, 1961	First Chairman of GKOT in 1957-58 participated in Tyura-Tam selection

Full Name	Date of Birth/Death	Contribution to the Soviet Space Program
Gonor, Lev Robertovich	1906–November 13, 1969	First Director of NII-88 in 1946–50 was dismissed in 1950
Grishin, Lev Arkhipovich	1920–October 24, 1960	Deputy Chairman of GKOT in 1958–60 died in the R-16 disaster
Ivashutin, Petr Ivanovich	1903-	First Deputy Chairman of KGB during Vostok in 1959–63 was later GRU Chief in 1963–88
Kalmykov, Valeriy Dmitriyevich	August 28, 1908–March 22, 1974	He was Minister of Radio-Technical Industry in 1954–74
Khokhlov, Nikolay Dmitriyevich	Unknown	Deputy Minister of General Machine Building in 1965–83 was responsible for quality control
Khrunichev, Mikhail Vasilyevich	April 4, 1901–June 2, 1961	Minister of Aviation Industries in 1946–53 was later in Gosplan
Khrushchev, Nikita Sergeyeovich	April 5, 1894–September 11, 1971	First Secretary of Central Committee in 1953–64 during the early space era chaired Council of Ministers in 1958–64
Kozlov, Froi Romanovich	August 18, 1908–January 30, 1965	He was Secretary of Central Committee for defense and space during Vostok in 1960–63
Leshchenko, Sergey Mikhaylovich	Unknown	He was First Deputy Minister of Aviation Industries in 1957–64
Litvinov, Valentin Yakovlevich	1910–1983	Director of Progress Plant in 1944–62 later was Deputy Minister of General Machine Building in 1965–73
Malenkov, Georgiy Maksimilyanovich	January 2, 1902–January 23, 1988	first Chairman of Special Committee No. 2 in 1946–47 oversaw missile program
Malyshev, Vyecheslav Aleksandrovich	February 16, 1902–February 20, 1957	Minister of Medium Machine Building in 1953–55 was first manager of Soviet defense industry
Mazur, Yevgeniy Vasilyevich	Unknown-1982	He was Deputy Minister of General Machine Building in 1965–82
Pashkov, Georgiy Nikolayevich	1911-	He was at Gosplan Second Department in 1946–51 and Deputy Chairman of Military-Industrial Commission in 1957–70
Petrovskiy, Boris Vasilyevich	June 27, 1908-	Minister of Health from 1965 to 1980 operated on Korolev
Pleshakov, Petr Stepanovich	July 13, 1922–September 11, 1987	Director of TsNII 108 in 1958–64 was then Minister of Radio Industry 1974–87
Pravetskiy, Vladimir Nikolayevich	Unknown	He was Chief of Third Chief Directorate in Ministry of Health
Rudnev, Konstantin Nikolayevich	June 22, 1911–August 13, 1980	Director of NII-88 in 1950–52 later chaired CKOT during Vostok in 1958–61

CHALLENGE TO APOLLO

APPENDIX B

Full Name	Date of Birth/Death	Contribution to the Soviet Space Program
Ryabikov , Vasily Mikhailovich	January 14, 1907– July 19, 1974	Chief of Third Chief Directorate of Council of Ministers in 1951–53 chaired Military-Industrial Commission in 1955–57 and Sputnik State Commission
Serbin , Ivan Dmitriyevich	1910–February 16, 1981	He was Chief of Defense Industries Department in 1958–81
Serov , Ivan Aleksandrovich	September 29, 1905– July 1, 1990	First Deputy Minister of Internal Affairs later chaired KGB in 1954–58
Shakhurin , Aleksey Ivanovich	February 25, 1904– July 3, 1975	He was People's Commissar for Aviation Industries in 1940–46
Smirnov , Leonid Vasilyevich	April 16, 1916–	Director of YuzhMash Plant in 1952–61 chaired Military Industrial Commission in 1963–85
Stalin , Iosif Vissarionovich	December 21, 1879– March 5, 1953	General Secretary of Central Committee in 1924–53 was Chairman of Council of Ministers in 1941–53
Stroganov , Boris Aleksandrovich	Unknown	He was Sector Chief, Central Committee Defense Industries Department
Tabakov , Gleb Mikhaylovich	1912–1993	Director of NII 229 in 1958–63 was later Deputy Minister of General Machine Building in 1965–81
Udarov , Grigoriy Rafailovich	1904–1991	Deputy Minister of General Machine Building in 1965–79 was responsible for ground complexes
Ustinov , Dmitriy Fedorovich	October 30, 1908– December 20, 1984	Chairman of Military-Industrial Commission during Sputnik and Vostok in 1957–63 was later Secretary of Central Committee for defense and space in 1965–76
Vetoshkin , Sergey Ivanovich	September 25, 1905– July 19, 1991	Directorate Chief in Ministry of Armaments was then First Deputy Chairman of Military Industrial Commission in 1958–65
Vladimirskiy , Sergey Mikhaylovich	Unknown	Deputy Minister of Radio Technical Industries in 1954–79 was earlier at KB 1
Zubovich , Ivan Gerasimovich	1901–July 18, 1956	Deputy Chairman of Special Committee No. 2 was then Deputy Minister of Armaments in 1949–51
Zverev , Sergey Alekseyevich	October 18, 1912– December 17, 1978	He was Chairman of GKOT during the Voskhod program in 1963–65

INDEX

Numbers

- 09 rocket, 6, 63, 847
IK spaceship, 195, 250; see also Object K spaceship
IKP spaceship, 251; see also Vostok-IP spaceship
IL circumlunar spaceship, 338–45, 346
IMI test vehicle of NI rocket, 555
2K spaceship, 195, 250
2RS high-speed aircraft, 221
3K spaceship, 195, 250
3KA spaceship, 363, 382, 386; see also Vostok-3A spaceship
3KD spaceship, 386, 448, 451–54, 506; see also Voskhod 2
3KV spaceship, 386, 410–13, 422, 423, 506, 507, 522, 523, 524; see also Voskhod
3RS high-speed aircraft, 221
4K spaceship, 195
5D51 engine, 494
5KM space fighter, 344
5NM Mars sample return project, 753–54
7K spaceship, 345–50, 383, 463, 493, 719, 801, 802; and design of, 347–48; see also Soyuz circumlunar project
7K-G spaceship, 635
7K-LI spaceship, 497–506, 546, 556–61, 654, 699–701; and launches in early 1967, 561–64; and launches in 1967–68, 610–22; see also LI circumlunar spaceship and Zond
7K-LIE spaceship, see LIE spaceship
7K-LIS spaceship, see LIS spaceship
7K-LOK spaceship, 493, 494, 495; see also LOK lunar orbiter
7K-OK spaceship, 465–73, 492, 494, 501, 502, 503, 546, 556, 557, 561, 565, 567, 569, 570, 571, 573, 575, 591, 596, 624–26, 629–33, 635, 636, 659, 670, 701, 702, 705, 706, 716, 722, 723, 766, 804, 840; see also Soyuz spaceship
7K-OK-T spaceship, 559
7K-PLK spaceship, 498, 502
7K-PPK spaceship, 473; see also Soyuz-P spaceship
7K-S spaceship, 635, 636, 716, 722, 769, 770, 794, 804, 809; and preparations for flight, 826
7K-T spaceship, 717, 774, 777, 804, 805, 807, 809, 815, 816; and design of, 769, 807–08, 810
7K-TG spaceship, 826, see also Progress spaceship
7K-TK spaceship, 473, 591, 592, 597, see also Soyuz-R spaceship
7K-VI military spaceship, 527, 596–99, 633, 828; see also Zvezda military station
8A91 booster, 175, 176, 201
8A92 booster, 151
8D423 engine, 545
8D726 engine, 322
8K11 missile, see R-1
8K71 missile, see R-7
8K71PS booster, 163–64, 166, 173–74, 201; see also Sputnik booster
8K71SN missile, 156
8K72 booster, 201–02, 203, 206, 226, 235, 251, 252
8K72K booster, 203, 235, 259, 273, 276, 338, 343, 353, 355, 356, 366, 368; see also Vostok booster
8K73 booster, 201–02
8K78 booster, 328, 388, 488, 525, 529; see also Molniya booster
8K78M booster, 640; see also Molniya booster
8K513 booster, 482
9K rocket block, 346–50, 463, 465; and design of, 348; see also Soyuz circumlunar project
10X cruise missile, 22, 227
10XN cruise missile, 227
11A51 booster, see N1 booster
11A52 booster, see N2 booster
11A55 booster, 348
11A56 booster, 348
11A57 booster, 410, 411, 421, 448, 469, 507, 523, 524, 525, 571; see also Voskhod booster
11A59 booster, 394
11A511 booster, 469, 474, 503, 571, 573, 574, 581, 596, 605, 610, 705, 826; see also Soyuz booster

* Note that page numbers in italics indicate photographs.

- 11A511L booster. 735
 11A511M booster 596
 11A514 booster 473
 11D23 engine. 543
 11D54 engine. 483. 649. 677
 11D56 engine. 483. 548. 649. 847
 11D56M engine. 757. 759
 11D57 engine. 483. 649. 757. 759. 847
 11D58 engine 488
 11D121 engine. 820
 11D416 engine. 543
 11D417 engine. 531. 642. 739
 11F25 space shuttle see Buran space shuttle
 11F71 spaceship. 473, see also Soyuz-R spaceship
 11F71 station (of Almaz). 591. 592. see also Almaz
 11F72 spacesh-p473; see also Soyuz-R spacesh-p
 11F72 spacesh-p(of Almaz). 806; see also Transport-Supply Ship
 11F74 spaceship (of Almaz). 592
 11F75 spaceship (of Almaz). 592. 807
 11F76 spaceship (of Almaz), 592. 593
 11F77 spacesh-p(of TKS). 807; see also FGB
 11F91 spaceship. 503, see also 7K-L1, L1, and Zond space-ship
 11F94 lunar lander. 491. see also LK lander
 11F615 spacesh-p465, see also Soyuz spaceship
 11F711 station. 597
 11K spacesh-p.346-50 463. 465; and design of. 348; see also Soyuz circumlunar project
 11K25 booster, see Energiya booster
 11S824 payload block. 556
 14X cruise missile. 227
 15D13 engine. 543
 16X cruise missile 227
 17K space station see DOS station
 19K module 802
 23rd Special Purpose Engineer Brigade of the Rocket Troops of the High Command. 72
 25 bomber see M bomber
 45K attitude control sensor. 575. 582. 583. 584. 589 625. 626
 50-50 spaceplane project see Spiral
 95 bomber, see Tu-95 bomber
 99K attitude control sensor. 557. 655
 100K attitude control sensor. 616, 618, 654
 101 attitude control sensor. 557
 101K attitude control sensor 655
 103 bomber 15
 110K attitude control sensor. 557
 130 spaceplane carrier. 600 605
 212 missile. 11 13
 217 missile. 16
-
- A**
-
- A-4 German missile, 18-21, 24-32, 34-35, 37, 40, 41-42, 45, 46, 49, 50, 53, 54, 58-60, 62, 64, 66, 68, 73, 76, 78, 81, 83, 84, 88, 92, 98, 101, 107, 130, 131, 185, 212, 275, 331, 364, 380, 477, 538, 570, 848; and Soviet launches of 55-57
 A-91A10 German missile concept, 75
 A-200 ICBM, see UR-200 ICBM
 A-300 booster. 234, 307
 Abramov, Anatoly P. 50, 118, 137, 160, 801
 Abramovich, Genrikh N. 51, 53
 Academy of Armaments Industry 90
 Academy of Sciences see USSR Academy of Sciences
 Admira camera. 510
 Advanced Research Projects Agency (ARPA). 317
 ADU-100 communications antennas. 536
 Aelita Mars project. 745-54
 Aelita novel. 745
 Aerobee missile, 92
 Aerojet Propulsion Division. 846, 847
 AFA-41/20 camera. 767
 AFA-M-31 camera. 767, 779
 Afanasyev, A. V. 64
 Afanasyev, Sergey A. 433, 480, 481, 482, 500, 503, 514, 517, 518, 527, 538, 539, 547, 553, 554, 570, 585, 591, 613, 621, 631, 632, 634, 644, 645, 646, 647, 648, 649, 658, 659, 671, 675, 678, 679, 680, 699, 701, 703, 714, 720, 722, 724, 728, 730, 731, 733, 738, 746, 750, 752, 759, 762, 771, 781, 783, 786, 790, 796, 797, 800, 803, 806, 809, 824; and background of, 430-31; and end of NI-L3 project. 832-33; and firing of Mishin, 830-31; and fourth NI launch. 822, and latter-day career, 844-45, and on Ustinov, 434, and second NI launch 692; and supported by Marshal Crechko 787
 Agadzhanov, Pavel A. 162, 427, 537, 583, 584, 656
 Agafanov, Sergey P., 825
 Agaltsov, Filipp A. 243, 281, 291
 Agat-1 telescope. 592
 Agence France Presse agency. 805
 Air Force Medical Service. 425
 AK-17 Kosmoplan. 307
 AK-1-300 Kosmoplan. 307
 AK-3-300 Kosmoplan. 307
 AK-4 Kosmoplan. 307
 Akademik Sergey Korolev communications ship. 816
 Akademik Shirshov research ship, 726
 Akim, Efraim 835
 Albina (dog). 95, 173, 181
 Albring, Werner. 30, 58, 63
 Aldrin, Edwin E., Jr., 694, 695, 696, 713
 Aleksandrov, Anatoly P. 313, 317, 750
 Aleksandrov, S. I., 448
 Aleksandrov, V., 220
 Alekseyev, Nikolay N., 287, 635
 Alekseyev, Semyon A. 172, 198, 199, 254, 264, 272, 356, 359
 All-Union Conference on Rocket Research into the Upper Layers of the Atmosphere. 182-83
 All-Union Conference on Stratospheric Studies, 9
 All-Union Conference on the Uses of Rocket-Propelled Craft for the Exploration of the Stratosphere 9
 All-Union Institute for Aviation Materials, see VIAM

CHALLENGE TO APOLLO

INDEX

- All-Union Scientific-Research Institute for Digital Computer Technology. 594
- All-Union Scientific-Research Institute for Electromechanics. 594, 683. *see also* NII-627
- Almaz program. 597, 598, 607, 633, 635, 729, 766, 768, 770, 787, 800, 804, 814, 840, and conversion to DOS. 720-21 and coordination of schedules with DOS. 808-09; and delays in late 1960s. 716-17; and description of space-ship. 592-96; and first crews for, 808. and origins of. 590-92, and preparations for launch of Almaz 1/*Salyut* 2. 810-11; and *Salyut* 2 mission. 811-12; and work in 1970-72. 806-07, and work in 1970s and 1980s. 841-43
- Amak-3 experiment. 778
- Ambartsumyan, Viktor A. 770
- An-2 aircraft. 248
- An-12 aircraft. 198, 263, 422, 473, 569, 630, 656
- Analytical Instrument Building Design Bureau. 472
- Anders (a German), 58
- Anders, William A. 667, 674
- Andropov, Yuriy. 432, 846
- Anikeyev, Ivan N. 246, 247, 374-75
- Anna-3 telescope. 767, 778
- Anokhin, Sergey N. 566, 567, 588
- Anti-Party Group affair, 161, 177
- antipodal bomber, *see* Sanger-Bredt bomber
- Antonov, Oleg K. 198, 218
- Appazov, Refat F. 44
- Apollo Applications Program (NASA). 714; *see also* Skylab
- Apollo program/spaceship (NASA), 383, 384, 396, 397, 398, 399, 402, 405, 406, 408, 409, 444, 446, 471, 475, 482, 483, 497, 499, 502, 539, 544, 550, 553, 554, 562, 595, 607, 614, 641, 646, 655, 661, 662, 668, 712, 736, 739, 741, 742, 750, 757, 772, 779, 827, 853, 857, 859; and financial comparison with NII-L3. 838. and Soviet comparison with Luna sample return missions. 740
- Apollo 1 fire. 554, 562, 629, 651, 658
- Apollo 4 mission. 643, 644
- Apollo 5 mission. 734
- Apollo 7 mission. 658, 660, 663
- Apollo 8 mission. 667, 674, 693, 701, 713, 716; and decision on. 662-63, and Soviet response to. 665-68, 674-678, 687, 746, 754
- Apollo 9 mission. 684, 734
- Apollo 10 mission. 684, 686, 687
- Apollo 11 mission. 687, 688, 693, 694-96, 699, 714, 729, 733, 737, 740, 750, 765, 788, 856, and Soviet response to. 696-97, 703
- Apollo 12 mission. 729, 740
- Apollo 15 mission. 763
- Apollo 16 mission. 793, 804
- Apollo 17 mission. 793, 806
- Apollo-Soyuz Experimental Flight (EPAS), *see* Apollo-Soyuz Test Project
- Apollo-Soyuz Test Project (ASTP). 43, 814, 848; and crews for. 814-15 and origins of. 793-94; and test flights for. 826
- Argon-11 computer. 558, 614
- Argon-12A computer. 594
- Armenian Academy of Sciences. 778, 817
- Armstrong, Neil A. 694, 695, 696, 699, 713, 724
- Arsenal Machine Building Plant. 648, 733, 754
- artificial gravity experiments. *see* IT project
- Artyukhin, Yuriy. 811
- Arzamas-16, 120
- AS-203 Apollo mission. 734
- ASA-34R camera. 593
- Atlas booster. 846
- Atlas ICBM. 80
- Atlet spacesuit. 767
- atomic bomb development. 36, 51, 86
- Avduevskiy Vsevolod S. 189, 313
- Aviation Week & Space Technology* journal. 552
- Azov Machine Building Plant. 769

B

- B-29 bomber. 36
- B-52A bomber. 600
- Babakin, Georgiy N. 437-38, 528, 533, 534, 547, 548, 640, 668, 675, 679, 687, 688, 737, 738, 753, 782, 848; and background of. 530. and death of. 795-96, and development of Ye-8-5 lunar sample return spaceship. 641-43; and Luna 15 mission. 694-96; and Mars sample return. 753-54
- Babiychuk, Aleksandr N. 425
- Bakurin 28
- Balanina, Mariya N. 111
- Barani training device. 248
- Baranov Central Institute of Aviation Engine Building *see* TsIAM
- Bardin, Ivan P. 145
- Barmin, Vladimir P. 29, 35, 46, 47, 132, 134, 136, 155, 156, 159, 170, 177, 192, 201, 254, 272, 289, 293, 330, 331, 356, 393, 429, 459, 480, 504, 538, 545, 550, 560, 563, 611, 619, 647, 692, 704, 755, 851; and background of. 549, and becomes Academician. 519-20 and death of. 846, and gets first Hero of Socialist Labor. 121; and gets second Hero of Socialist Labor. 284. and Long-Duration Lunar Base. 764-66
- Baryshev, Vladimir M. 300
- Bashkin, Yevgeniy V. 813
- Batitskiy, Pavel F. 790
- Bauman Moscow Higher Technical School. 3, 85, 127, 183, 189
- Baykonur Cosmodrome. 512, 574, 579, 621, 625, 629, 655, 658, 659, 665, 680, 681, 688, 699, 700, 703, 705, 723, 772, 773, 805, 810, 851; and creation of name. 284; *see also* Tyura-Tam
- Bazhinov, Igor K. 85, 139, 140
- Belka (dog). 253
- Belov, Nikolay P. 183, 186
- Belyayev, Pavel I. 246, 247, 421, 461, 506, 512, 551, 609, 620, 717; and background of. 451-52, and Voskhod 2 mission. 454-60
- Benderov, Vladimir N. 415
- Beregovoy, Georgiy T. 522, 524, 622, 629, 630, 674, 693, 724; and Soyuz 213 mission. 657-62
- Bereznyak, Aleksandr Ya. 17, 19, 29, 31

- Beriya. Lavrentiy P. 12. 14. 22. 23. 36. 37. 38. 42. 53. 88. 109-12. 117. 119. 123. 135. 140. 151. 176. 258. 430. 503. 704-05
- Beriya. Sergey L. 227
- Berkut spacesuit. 450-51. 509
- Bezhitsa tracking ship. 534
- Bezverbiy. Vitaliy K. 676
- Bl-1 rocket-plane. 17. 19
- Biofizpribor Special Design Bureau, *see* SKB Biofizpribor
- Bios-1 biosphere. 746
- Biryuzov. Sergey S. 369. 373. 377. 379. 380
- Bisnovat. Matus R. 836
- Bison-A bomber *see* M-4 bomber
- Blagonravov. Anatoliy A. 65. 67-69. 87. 88. 93. 95. 96. 132. 148. 169. 283. 412. 685. 697
- Blass. Josef. 30. 45. 63
- Bleicherode. 28. 30. 31. 40
- Blok A stage of LK-1 project. 501. 502. 503
- Blok D stage of N1 and Proton. 327. 328. 483. 491. 492. 493. 495-96. 530. 532. 562. 563. 638. 640. 642. 648. 650. 654. 681. 688. 733. 737. 739. 742. 748. 821. 825; and accident with. 621; and description of. 487-88; and Earth orbit test of. 734; and ground firings of. 639; and LI Zond project. 501-06. 556-59. 663, and summary of flights in 1967-70. 738
- Blok DM stage of N1. 757. 760. 761
- Blok I stage of N1. 492. 493. 494. 495. 497. 548
- Blok R stage of N1. 483. 548. 649. 757. 759
- Blok S stage of N1. 483. 649. 687. 750. 757. 758. 759
- Blok S₀ stage of N1. 758
- Blok S₁ stage of N1. 757-61. 802
- Blok V stage of N1. 483. 485
- Blok Y6 stage of N1. 492. 493. 497. 548. 639. 733. 735-36; and first ground firing of. 684
- Blokhin. Yuriy D. 601. 835
- Bobik (dog) 95
- Bogomolov. Akhsey F. 155. 155. 157. 172. 201. 254. 272. 289. 356. 359. 421. 422. 820
- Boguslavskiy. Yevgeniy Ya. 28. 35. 78. 110
- Bolkhovitinov. Viktor F. 17. 18. 20. 21. 48. 51. 200. 461. 848
- Bolshevo. 39. 49. 85. 263. 535. 618
- Bolshoy. Amos A. 263. 453. 535
- Bolshoye koltso lunar base. 764
- bombers, strategic. 126. 128
- Bondarenko. Valentin V. 246. and death of. 266
- Bondaryuk. Mark M. 48. 53. 107. 126. 127. 318
- BOR-1 spaceplane. 606. 787-88. 790
- BOR-2 spaceplane. 606. 789. 790
- BOR-3 spaceplane. 606. 789. 790
- BOR-4 spaceplane. 789. 841
- Borisenko. Ivan. 155
- Borisenko. Mikhail I. 78
- Borman. Frank. 511. 662. 667. 674. 696. and visit to Moscow. 693
- Borodin. Sergey A. 490
- Borovich ship. 656
- Borovkov. Aleksey A. 21
- Bozhko. Andrey N. 746
- Bredt. Irene. 32
- Brezhnev. Leonid I. 177. 178. 179. 215. 218-19. 270. 281. 282. 367. 385. 404. 406. 408. 412. 418. 426. 427. 428. 432. 434. 436. 437. 459. 499. 513. 518. 552. 555. 577. 579. 587. 590. 598. 600. 627. 628. 644. 658. 674. 686-87. 692. 701. 703. 705. 709. 737. 758. 787. 790. 810. 813. 830. 834. 846. 858; and firing of Mishin. 831; and gets second Hero of Socialist Labor. 284, and origins of Buran. 835; and space station speech in 1969. 711-13. 714-15; and Voskhod 2 mission. 456
- Brykov. A. V. 85
- Budker. Andrey I. 635
- Budnik. Vasilii S. 29. 35. 42. 43. 50. 91. 97. 113. 114. 492
- Bugayskiy. Viktor N. 646. 806. and background of. 721; and space station decision in 1969. 718-22
- Bugrov. Vladimir N. 566. 567
- Bulganin. Nikolay A. 110. 117. 119. 121. 149. 156
- Bulychev. Ivan. 155
- Buran cruise missile. 127. 130. 224. 225. 318. 718
- Buran space shuttle. 842. 849. 850. 851; and end of project. 840-41; and origins of. 835-36. 837
- Bureau for the Investigation of Reactive Engines and Reactive Flight. 4
- Burnazyan. Avetik I. 414. 417. 525. 567. 647
- Burya cruise missile. 126. 127. 130. 300. 318; and flights of. 223-24
- Bushuyev. Konstantin D. 17. 19. 43. 50. 59. 63. 70. 73. 85. 94. 121. 133. 141. 151. 155. 163. 190. 195. 199. 254. 260. 264. 291. 327. 336. 338-40. 355. 359. 365. 381. 391. 397. 472. 479. 481. 488. 518. 572. 576. 578. 580. 588. 634. 636. 644. 645. 665. 769. 783. 785. 809. 827. and background of. 152. 461-62; and death of. 848. and gets Hero of Socialist Labor. 177; and name revealed. 794, and power struggle in TsKBEM. 828; and space station decision in 1969. 717-22
- Butoma. Boris Ye. 269
- Buylov. Boris G. 93
- Bykov. Yuriy S. 201. 272. 274. 471
- Bykovskiy. Valentin F. 246. 247. 248. 249. 261. 352. 353. 356. 363. 364. 381. 397. 551. 568. 577. 615. 620. 622. 653. 655. 657. 667. 678. 779. 853. and lunar program training. 684. and Soyuz 1. 577-80. 588. and Vostok 516 mission. 365-73
- Byurakan Astrophysical Observatory. 766. 818

C

- Cameron. Alexander M. 32
- Cape Canaveral. 263
- Cape Kennedy. 643. 644. 667
- Centaur upper stage. 317. 389. 759
- Central Artillery Design Bureau, *see* TsAKB
- Central Commission for Aviation Medicine. 244
- Central Directorate of Space Assets, *see* TsUKOS
- Central Intelligence Agency. *see* CIA
- Central Planning Institute No. 31. *see* TsPI-31
- Central Scientific-Research Aviation Hospital. 244. 245. 247. 508. 567. 623
- Central Scientific Research Institute No. 58. *see* TsNII-58

CHALLENGE TO APOLLO

INDEX

- Central Scientific-Research Institute of Machine Building, see TsNIIIMash
- Cernan, Eugene. 526
- Chaffee, Roger B. 562
- Charin, A. I., 78
- Chayka (dog), 252
- Chayka orientation system. 200. 226 251
- Chechulin, Petr. 102
- Chekunov, Boris S., 166. 167
- Chelomey, Vladimir N., 227-36, 239, 287, 289, 313, 314, 320, 322-24, 330, 333-45, 347, 349, 379, 395, 396, 400, 402, 406-08, 429, 432, 463, 473, 480, 487, 512, 520, 530, 548, 556, 560, 599, 600, 601, 602, 613, 616, 619, 621, 633, 635, 642, 679, 687, 762, 766, 786, 791, 804, 825, 828, 836, 837, 840, 852, and Aelita Mars project, 750-54; and agreement with Mishin on space station, 808-09; and Almaz *Isalyut* 2 mission, 810-12; and becomes Academician, 313, and "big space plan," 241-42, and "civil war" over missiles, 787, and early life, 21; and early work, 21-22, and end of life, 841-43, and gets Hero of Socialist Labor, 229, and in trouble after fall of Khrushchev, 436-46; and Li launches in early 1967, 561-64; and launch of Polet-1, 393-94; and LK-1 circumlunar program, 443-46, 497-502; and LKS proposal, 835; and Operation *Kedr*, 418-21; and opinion of Korolev, 843; and origins of Almaz program, 590-96; and personality of, 227-28, 427, and problems with Proton rocket, 738-39; and relationship with Khrushchev, 314, and relationship with Korolev, 234, 394, and relationship with Ustinov, 233, 419-20, 787, and rise of in early 1960s, 299-314; and space station decision in 1969, 716-22, and supported by Minister Afanasyev, 787; and UR 700/LK 700 program, 538-46, 645-46
- Cheremukhin, Aleksey M., 14
- Chernenko, Konstantin, 432, 846
- Chernigovskiy, Vladimir N., 93
- Chernushka (dog), 265
- Chernyakov, Naum S., 300
- Chernyshov, Nikolay C., 64, 67
- Chertok, Boris Ye., 17, 19, 26-31, 35, 44, 57, 58, 90, 110, 113, 121, 133, 238, 252, 272, 327, 340, 391, 397, 417, 463, 465, 475, 479, 514, 515, 518, 537, 562, 571, 572, 582, 584, 589, 618, 631, 634, 644, 645, 675, 676, 681, 801, 809, 821, 827, 838, and background of, 462, and fourth NI launch, 822-23, and latter-day work, 848-49; and power struggle in TsKBEM, 828; and space station decision in 1969, 717-22
- Chibis suit, 767, 780
- Chief Artillery Directorate, see CAU
- Chief Directorate of Reactive Armaments, see GURVO
- Chief Directorate of Space Assets, see CUKOS
- Chief Directorate of Special Construction, 134-35
- Chief Operations and Control Group (COCU), 453, 535-38, 572, 582, 584, 616, 625, 656, 659, 775, 781, 811
- China, 290
- Chizhevskiy, Vladimir A., 14
- Chizhikov, Semyon C., 29
- Chukotka tracking ship, 263
- Churchill, Winston, 18, 87
- CIA, 84, 205, 374, 432, 550-51, 647, 662, 687, 708, 709, 784, 791, 792-93
- circumlunar projects, early conceptions of, 337-45, 395-96
- Clark, Evert, 550
- Collins, Michael, 609, 694
- Command-Measurement Complex, see KIK
- Commission for the Investigation of the Upper Atmosphere, 69, 96
- Commission for the Promotion of Interplanetary Flights, 610
- Commission for the Study of the Stratosphere, 56, 69
- Committee for State Security, see KGB
- Coordination-Computation Center, at NII-4, 162, 167; and at TsNIIIMash, 618, 655
- CORONA program, 251, 793
- cosmonauts, selection of 1960 batch, 243-46; and disreputable behavior of, 295, and from USSR Academy of Sciences, 623-24; and journalist cosmonauts, 624, and political "correctness" of, 416-17, 817, and selection of civilians, 565-69, and training for Moon program, 561, 650-51, 657, 684-85
- Cosmonaut Maneuvering Motion Unit (UPMK), 509, 526-27
- Cosmonaut Training Center, 246, 352, 353, 365, 374, 383, 415, 451, 513, 561, 623, 627, 650, 667, 684, 693, 723, 724, 728, 729, 777, 786, 796, and expansion of, 375-76; and first civilian cosmonauts, 566-69; first Western visit to, 792, and formation of, 245
- Council for the Problems of Mastering the Moon, 553, 644
- Council of Chief Designers, 47, 50, 62, 90, 92, 141, 148, 169, 179, 188, 193, 200, 201, 210, 217, 241, 250, 254, 336, 367, 503, 505, 519, 554, 560, 581, 594, 632, 675, 677, 704, 705, 754, 772, 791, 823, 833, 841; and approval of piloted project, 192, and as innovative institution, 857-58; and fate of members, 846, and style of work, 289
- Council of Defense, 322, 598
- Crimea, 292, 413, 422, 536, 642, 777
- Crimean Astrophysical Observatory, 767
- cruise missiles, early development of, 105-07, 125-27
- Cuba, 295, 535, 547
- Cuxhaven, 32, 34, 40
- Czechoslovakia, 31, 37, 295, 412, 587

D

- D-1 missile, 16-17
- D-2 engine, 76, 99
- D-2 missile, 16-17
- Dal anti-aircraft missile system, 223-24
- Dal lunar base, 764
- Damka (dog), 186
- Darevskiy, Sergey C., 467, 727
- Debica (Poland), 18, 21
- Defense Industries Department, of the Central Committee, 205, 233, 271-72, 300, 515, 553, 568, 675
- Delta booster, 846
- Delta navigation system, 809
- Dementyev, Petr V., 16, 19, 20, 21, 222, 233, 235, 269, 379, 420, 547, 613, 631, 647, 823
- Demin, Lev, 522, 811
- Denerhkin, Igor I., 135

Department of Applied Mathematics in the V. A. Steklov Mathematics Institute of the USSR Academy of Sciences see OPM MIAN

Design Bureau No. 7 see KB 7

Design Bureau of Chemical Automation 592, 615, 752, 825 see also OKB 154

Design Bureau of Chemical Machine Building 548, 557, 649, 768, 795 see also OKB 2

Design Bureau of General Machine Building 549, 764 see also GSKB SpetsMash

Design Bureau of Power Machine Building 613, 791 see also OKB 456

Design Bureau of Precision Machine Building 594, 596 see also OKB 12

Design Bureau Olimpiya 35, 37

Dezik (dog) 95, 96

Directorate of the Commander of Reactive Armaments 211

Directorate of the Deputy Commander of Artillery 124

Discoverer 13 mission 253

Discoverer program 251

Dnepropetrovsk 97, 113, 114, 164, 177, 285, 431, 434

Dobrovolskiy Georgiy T. 613, 799, 818 and becomes primary crew for Soyuz 11, 776-77 and reconstruction of Soyuz 11 accident, 783-84 and Soyuz 11 mission, 777-81, 785 and training for *Salyut*/DOS 1, 772

Dobrynin Anatoliy 693

dogs in space 92-97

DOK see Engine Orientation Complex 648

Dolgoplov Gennadiy A. 566, 567

Dolgov Petr I. 198

Dolinsk tracking ship 263, 703

Domberger Walter 18

Dorofeyev Boris A. 681, 756, 819, 822, 838 and fired from TskBEM 833 and power struggle in TskBEM 828

DOS space station 729, 816, 817, 828 and conflict over two docking ports 829 and design of 766-69 and DOS 2 mission 804, 06 and DOS 3 mission 813-14, 815 and first crews for 770 and future plans for 769-70 and improved DOS changes 809, 10 and initial schedule for 771, 72 and launch of DOS 1, 773-74 and modernized variants in 1973-74, 826-27 and origins of 713, 22 and relationship to MKBS 800 and schedule coordinated with Almaz 808-09 and work in 1970s and 1980s 839-40 see also *Salyut* stations

DOS 7K space station complex 719, 769, 771, 782, 794, 804 see also DOS and *Salyut* space stations

DOS A station 770

DOS N station 770

Dryden Hugh L. 399

Dryden Flight Research Center 599

Dubna Machine Building Plant 601

Durant Fred C. 146

Dushkin Leonid S. 48, 53

Dymshits Veniamin E. 350

Dyna Soar spaceplane 220, 225, 306, 312, 590, 599, 601, 606, 607

Dzerzhyskiy B. 70

Dzerzhinskiy Military Academy 135

E

Eidiz, Arkadiy I. 437

Eisenhower Dwight D. 146, 147, 151, 193, 237

ÉKR cruise missile. 106, 107, 125, 126

Elbrus couches. 411, 421

Elektron satellite, 381

Energiya booster, 492, 836, 837, 840-41, 849, 850, 851

Energiya Rocket-Space Corporation. see RKK Energiya

Energiya Scientific-Production Association, see NPO Energiya

Eneyev, Timur M. 103, 142, 189

Engine Operation Control system, see KORD system

Engine Orientation Complex (DOK) 648, 733

EPOS spaceplane testbed. 605-07, 787-90; see also Spiral

ERA instrument. 768, 779

EU-15 test stand. 638

EU-16 test stand. 638

EU-27 test stand. 638

EU-28 test stand. 638

EU-29 test stand. 638

Experimental Design Bureau of the Lavochkin State Union Machine Building Plant. see OKB-301

Experimental Design Bureau of the Moscow Power Institute. see OKB MEI

Experimental Machine Building Plant (of Myasishchev). 836

Experimental Machine Building Plant (of TskBEM) 637, 715, 831; see also Plant No. 88

Explorer I satellite 83, 174

F

Faget Maxim A. 193

Fakel experiment. 707

Fartushniy Vladimir G. 623, 702

Fatkullov Mars N. 623

Faulstich (German scientist). 82

Fedorov, Petr I. 17-19, 21

Fedorov, Yevgeniy, 247

Fedoseev Piotr, 313

FEK emulsion chamber. 778

FEK-7A camera. 767

Feodosiya testing ground. 413, 416, 422, 473, 561, 569, 624

Feoktistov, Konstantin P. 194, 198, 252, 254, 264, 273, 275, 334-38, 345, 359, 422, 477, 478, 504, 507, 547, 581, 609, 693, 745, 746, 770, 785, 809, and design of first piloted spaceship. 188-93; and design of Voskhod 409 and power struggle in TskBEM. 828, and role in space station decision. 714, 717 and selection for Voskhod mission 415-18 and Voskhod (1) mission. 423-26

FCB module. 807, 840, 843

Fi-103 German cruise missile. 18, 19-20, 21, 22, 24-26, 227, 228

FIAN institute. 48, 49, 56, 767

FIAR-1, 70

Filatov, Valentin I., 246, 247, 374-75

Filipchenko, Anatoliy V. 804, and Soyuz 6/7/8 mission. 705-11

Finogeyev, Vladlen P. 676

- First Chief Directorate of the USSR Council of Ministers 111
 Flerov Petr V. 198, 412, 413
 Fletcher James C. 765
 Flight Control Center (TsUP) at Kaliningrad 618
 Floreyskiy 28
 Florianskiy Mikhail S. 336
 Foton communications system 547
 Fourth Directorate of Chief Artillery Directorate 39, 61, 124
 Fractional Orbital Bombardment System (FOBS) 482
 Freon fire extinguisher system for NI 732
 Frolov Yevgeniy A. 409, 421
 Frunze Central Airfield 245
 Functional Cargo Block (FCB) *see* FCB module
 funding of Soviet space program 552-53, 838 and public displeasure with 794
-
- G**
-
- G-1 German missile. 58, 59, 60, 61, 63, 72, 73, 80, 81, 83
 G-1M German missile, 81
 G-2 German missile. 80
 G-3 German missile. 81-82
 G-4 German missile. 81, 82
 G-5 German missile. 81, 82
 Gagarin, Yuriy A. 246, 247, 249, 271, 273, 287, 290, 291, 295, 312, 314, 337, 343, 350, 351, 353, 355, 356, 359, 365, 370, 372, 374, 383, 396, 406, 413, 421-23, 451, 454, 458, 461, 513, 551, 568, 575, 577, 579, 607, 616, 619, 622, 625, 669, 705, 772, 773, 792, 840, 852, 856, 858, 859, and background, 261-62 and death of, 627-29; and moves to desk job, 375 and postflight press conference, 283, and selection for first spaceflight, 271-72, and Soyuz 1 mission, 577, 579, 580, 581, 584, 588, and Vostok (1) mission, 276-82; and Vostok (1) mission preparations, 274-76; and work in 1960s, 568-69, 626-27
 Gagarin Cosmonaut Training Center *see* Cosmonaut Training Center
 Galkovskiy, Aleksandr. 140
 Gallay, Mark L. 248, 264, 271, 275
 Gas Dynamics Laboratory, *see* CDL
 Gatland, Kenneth. 695
 CAU. 8, 19, 25, 29, 36, 54, 55, 61, 87, 91, 124, 211
 Gaydukov, Lev M. 20, 29, 30, 33, 34, 37, 39, 40, 42, 116
 Gazenko, Oleg G. 173, 291, 376
 CDL. 6-7, 8, 98
 Gemini program (NASA), 383-86, 395, 443, 447, 453, 512, 513, 522, 525, 526, 553, 565, 577, 668
 Gemini-B spaceship. 590, 595
 Gemini III mission. 460
 Gemini IV mission. 386, 526
 Gemini V mission. 510
 Gemini VI mission. 511
 Gemini VII mission. 510, 511, 522, 526, 702, 723, 727
 Gemini VIII mission. 674
 Gemini IX mission. 526
 Gemini XI mission. 526
 Genin, Abram M. 183, 271, 376
 GeofIAN institute. 70, 71, 181
 Geofizika Design Bureau. 618
 Geophysical Institute of the Academy of Sciences *see* GeofIAN institute
 German scientists in the USSR. 57-63, 80-84
 Germany. 3, 18, 367, 380, and recovery mission in 1945-46, 25-37, 40-42, 212, 364, 461, 570, 704, 838, 848
 Gilruth, Robert R. 193
 GIRD. 4-7, 8, 15, 28, 30, 44, 45, 48, 68, 76, 90, 117, 267-68, 412
 Gitzelzon, Iosif I. 746
 Gladkiy, Viktor F. 44
 Glenn, John H. Jr. 296, 354, 424
 Clennan, T. Keith. 192
 Gliding Space Apparatus *see* PKA
 Globus instrument. 196, 467
 Glushko, Valentin P. 6-7, 8, 10, 12, 22, 34, 46, 47, 57, 76, 98, 100, 101, 114-16, 127, 129, 141, 147, 150, 155, 156, 159, 165, 166, 177, 179, 192, 199, 201, 224, 237-39, 242, 254, 258, 272, 275, 287, 289, 301, 319-21, 328-330, 335, 347, 365, 387, 388, 390, 429, 433, 434, 475, 479, 480, 483, 504, 510, 512, 519, 520, 538, 541, 545, 546, 549, 563, 613, 649, 687, 704, 763, 783, 786, 792, 836, 837, 838, 841, 842, 843, 846, 848, 852, 853, 858; and arrest of, 11, 13; and at OKB-5D in Kazan, 16, and becomes Academician, 177, and becomes head of NPO Energiya, 830-32; and conflict over R-9 and R-16 ICBMs, 214-19 and conflicts with Korolev, 108-09, 130, 202, 214-19, 237-38, 397-98 and continuing criticisms of NI, 548, and death of, 851; and development of UR-500 Proton booster, 302-04 and early discussions on NI engines, 314-18 and engine development in early 1970s, 824-25; and gets first Hero of Socialist Labor, 121 and gets second Hero of Socialist Labor, 284, and in Germany, 30-32, 34-37; and Korolev's memory in later years, 849-51; and MTKVP proposal, 835 and name publicly revealed, 791 and new booster and Moon base proposals in 1974, 834, and nuclear rocket engines, 318; and personality of, 850; and reaction to Korolev's death, 515 and rehabilitation for "crimes," 176; and secrecy, 169-70, 373-74; and support of UR-700, 646-47 and suspends NI project, 832, and UR-700M, 752
 Goddard, Robert H. 14
 GOCU, *see* Chief Operations and Control Group
 Colovanov, Yaroslav K. 272, 412, 461, 624, 776, 797, 838, 852
 Gonor, Lev R. 39, 40, 43, 58, 81, 90, and death of, 91
 Corbachev, Mikhail S. 432, 844, 846, 851
 Gorbatko, Viktor V. 246, 247, 451, 509, 567, 577, 588, 631, 717, 725, and Soyuz 6/7/8 mission, 705-11
 Corodomlya Island. 45, 50, 53, 60, 73, 80-82
 Coryunov 28
 Gosplan. 123, 431, 654, 845
 CR-1 orbital bombardment system (Chelomey), 313
 GR-1 orbital bombardment system (Korolev), 321-22, 323, 327, 328, 381, 387, 388, 392, 483, 486, 488, and approval of, 331 and problems in development of, 389-90, 482
 GR-2 orbital bombardment system. 305, 313
 Grechko, Andrey A. 377, 378, 380, 430, 555, 786, 787, 806, 842, 844; and Spiral program, 789-90 and suspends NI project, 832

Crechko, Georgiy M . 154. 158. 166. 566. 567. 645. 804. 806
 Grif attitude control sensor. 252
 Grigorovich, Dmitriy P. 3
 Grigoryev, Mikhail C. 72. 811
 Grishin, Lev A. 257
 Crissom, Virgil I. (Gus). 295. 351. 562
 Grizodubova, Valentina S. 12
 Gromov, Mikhail M. 12
 Gromov Flight Research Institute. 248. 249. 261. 309. 472.
 561. 566. 588. 624. 650. 684. 685. 787. 789. and Spiral
 spaceplane program. 599
 Crotrup, Helmut 30. 35. 42. 45. 55. 58. 59. 60. 63. 80. 82.
 83
 Crotrup, Irmgard. 82
 ground communications network, see KIK
 Croup for Study of Reactive Motion, see GIRD
 Grumman Aircraft Engineering Corporation. 397
 GSKB SpetsMash. 46. 132. 137. 201. 331. 393. 429. 480. 549.
 see also Design Bureau of General Machine Building
 GTsP-4. 54. 73. 133, see also Kapustin Yar launch range
 Cubanov, Boris I. 492
 Cubarev, Aleksey A. 636. 806
 Cubenko, Yevgeniy S. 536
 Guinea 535
 CUKOS 735 and formation of. 787, see also TsUKOS
 GULag. 13. 14. 23. 34. 41. 200. 215. 549
 Culyayev, Rudolf A. 623
 Curko, Oleg V. 85. 140
 Gurovskiy, Nikolay N. 244. 291. 376
 GURVO. 211-12. 284. 377. 380. 389
 Gurzut, Grigor. 817
 Gusev, Leonid. 356

H

Hagerty, James C. 146
 Hamburg 82
 Hawaii, Viktoria radio control system 78
 Heavy Interplanetary Automatic Ship see SNM Mars sample
 return project
 Heavy Interplanetary Ship see TMK
 Heavy Orbital Station see TOS
 heavy lift boosters early conceptions of 236-40
 Hermes Project 57
 Hiroshima 36
 Hitler, Adolf 23. 24. 367
 HL 10 lifting body 599
 Hoch johdnes 30. 55. 56. 58. 63. 72. 82
 Hochruth, M. 32
 Holloway, David 858
 Hungary 31. 295. 551. 620. 685
 Hypersonic Booster Aircraft (CSR) for Spiral 789

I

Iceland 295
 Iglu radar system. 340. 469-71. 492. 580. 581. 625. 639. 659.
 661. 701. 708. 711. 766. 769. 772. 774. 777. 804
 ICY, see International Geophysical Year

I-2 aircraft 721
 I-4 aircraft. 263
 I-14 aircraft. 271. 362
 I-18 aircraft. 585
 Ilichevsk tracking ship 263. 534
 Ilyin, 674
 Ilyushin, Sergey V., 218. 521. 721
 IMBP see Institute of Biomedical Problems
 Impuls instrument. 767
 India 295. 742. 847
 Indian Ocean. 559. 611. 654. 655. 656. 657. 664. 726. 742.
 755. 814
 Indian Space Research Organization, 847
 Institute Berlin, 31. 35. 46
 Institute for Biomedical Problems (IMBP). 472. 508. 511. 523.
 524. 565. 749. 773. 776, and formation of. 376
 Institute Nordhausen. 35
 Institute of Applied Geophysics. 187
 Institute of Applied Mathematics 537. 624. 641. 835
 Institute of Atomic Energy. 317
 Institute of Automation and Heat Technology. 415
 Institute of Aviation (and Space) Medicine. 92. 93. 94. 173.
 183. 243-45. 266. 271. 309. 352. 365. 375-76. 414-15.
 508. 614. 806
 Institute of Nuclear Physics. 635. 790. 791
 Institute of Radio-technology. 164
 Institute of Space Research. 586. 623. 770. 848; and forma
 tion of. 136
 Institute of Telemechanics and Automation 415. 507
 Institute of Terrestrial Magnetism, Ionosphere and Radio
 Wave Propagation. 624
 Institute of Theoretical and Applied Mechanics. 602. 789
 Institute Rabe. 28-31. 34. 35
 intelligence information on Soviet space program, see U.S.
 intelligence on Soviet missile and space programs
 intercontinental ballistic missile (ICBM). early development
 of. 74-75. 89. 97-98. 102-09. 128-33
 Interdepartmental Commission for the Coordination and
 Control of Work in the Field of Organization and
 Accomplishment of Interplanetary Communications. 145.
 169. 374
 Interdepartmental Scientific-Technical Council of the USSR
 Academy of Sciences. 209. 287. 290. 347. 349. 381. 383.
 397. 473. 479. 498. 519. 532. 849. and formation of. 210
 Interkosmos agency 794
 International Astronautical Federation (IAF) 146. 661
 international cooperation. Soviets with NASA. 793-94
 International Geophysical Year (ICY) 145-48. 154. 155. 160.
 166. 250. 374. 711
 International Space Station (ISS). 126. 248. 807. 840. 844
 Iosifyan, Andronik I. 487. 594
 IS satellite. 235. 242. 304. 312. 394. 419. 473. 540. 598
 Isayev, Aleksey M. 17. 19. 20. 25. 28. 29. 31. 48. 51. 63. 98.
 101. 102. 130. 199. 200. 217. 254. 272. 315. 317. 356.
 388. 429. 483. 495. 519. 543. 545. 548. 557. 649. 757.
 759. 768. 847. and death of. 795. and gets Hero of
 Socialist Labor. 121
 Ishlinskiy, Aleksandr Yu. 156. 365
 Iskhup ground tracking station, 162. 262

INDEX

IT artificial gravity project. 507-08, 522, 527
 ITSK spectrometer. 767
 Ivanov Pavel I., 48, 66, 68
 Ivanovskiy, Oleg G., 163, 166, 274, 530, 741
 Ivashutin, Petr I., 268
 Ivensen, Pavel A., 302
 Izotov, Sergey, 543
 Izhvestiya newspaper. 266, 852, 853

J

Jaffke, Heinz, 81, 83
 Jodrell Bank radio telescopes. 529, 655
 Johnson Lyndon B., 237, 296, 312, 590
 Jupiter missile, 81
 Jupiter C missile, 153, 166

K

Kaganovich, Lazar M., 121
 Kalina instrument, 767
 Kaliningrad, 38, 40, 41, 43, 45, 50, 57, 60, 63, 71, 73, 81, 82, 89, 101, 107, 115, 153, 172, 195, 225, 315, 351, 421, 461, 462, 463, 466, 501, 521, 531, 537, 611, 618, 631, 649, 715, 718, 795, 831
 Kalmykov, Valeriy, 165, 269, and gets Hero of Socialist Labor 284
 Kama stations, 156
 Kamanin, Nikolay P., 247, 249, 261, 262, 264, 266, 267, 269, 273, 274, 276, 291, 294, 195, 312, 352, 354, 364, 374, 375, 378, 384, 403, 421, 422, 508-10, 511, 512, 513, 522, 525, 545, 552, 553, 555, 560, 561, 563, 571, 573, 598, 611-12, 615, 616, 619, 622, 625, 626, 630, 631, 634, 646, 647, 650, 651, 653, 655, 657, 658, 659, 665, 667, 668, 669, 675, 679, 686, 693, 701, 703, 762, 770, 771, 772, 786, and background of, 245-46; and crew change on Soyuz 11, 776-77; and death of, 797, and death of Gagarin, 627-29; and diaries of, 852-53; and personality of, 797, and promotions, 376, and retirement of, 796, 804; and selection of civilian cosmonauts, 566-69; and selection of Gagarin, 271-72, and selection of Voskhod crew, 416-18; and Soyuz 1 mission, 576-90; and Soyuz 9 mission, 723-29, and Soyuz 11 mission, 780, 781, 783, 784; and Voskhod (1) mission, 423-26, and Voskhod 2 mission, 447, 452, 454, 459-60; and Vostok 3/4 mission, 353-61; and women cosmonaut training, 362
 Kamchatka peninsula, 157, 160, 167, 177, 224
 Kamyinin, Sergey S., 103
 Kapitsa, Petr L., 141
 Kapustin Yar launch range, 54, 55, 56, 60-63, 70-72, 73, 89, 95, 100, 101, 116, 119, 120, 133, 135, 136, 138, 149, 153, 159, 164, 181, 186, 212, 223, 227-30, 263, 274, 275, 310, 463, 503, 538, 570, 574, 614; see also GTS-4
 Karaganda, 372, 630, 661, 672, 710, 711, 728, 775
 Karas, Andrey G., 263, 435, 634, 655, 659, 724, 755, 786, 787, 800, 811, 812
 Kardan ground test system, 471
 Karpov, Yevgeniy A., 244-46, 247, 249, 273, 274, 291, 355, 365, 373

Kartashov, Anatoliy Y., 246, 249
 Kartukov, Ivan I., 196, 410, 469, 472
 Kasho, Aleksandr S., 44, 202
 Kaskad orientation system, 809
 Kaspiy suit backpack, 490
 Kasyan, Ivan I., 183
 Katys, Georgiy P., 507, 510, 522, 623, 624, and selection for Voskhod, 415-18
 Katyusha rockets, 17, 19, 20, 25, 29, 46, 49, 54, 549
 Kazakhstan, 134, 158, 253, 292, 372, 453, 558, 611, 619, 630, 660, 661, 669, 672, 700, 710, 740, 755, 775
 KB-1, 227, 309, 314
 KB-7, 8
 KB-11, 116, 128
 KB-82, 836
 KB-90, 836
 KB Burevestnik, 836, 837
 KB Energomash, 752, 791, 824-25; and becomes part of NPO Energiya, 830-31; see also OKB-456
 KB Molniya, 836, 837, see also OKB-4
 KB Nauka, 490, 561; see also OKB-124
 KB Salyut, 840, 842, 843, see also OKB-23 and TsKBM Branch No. 1
 KB Saturn, 649, 759, see also OKB-165
 KB Trud, 638, 752; and modernization of NI engines, 731-32, see also OKB-276
 KB Yuzhnoye, 639, 734, 760, 796, 814, and Aelita Mars project, 750, see also OKB-586
 KB Zvezda, 490, 527, 561, 640, 746, 775, 785, see also Plant No. 918
 Keggstrov tracking ship, 534
 Keldysh, Mstislav V., 48, 51, 52, 53, 69, 75, 79, 102, 103, 107, 125, 127, 130, 133, 141, 142, 147, 148, 150-52, 155, 156, 165-67, 177, 187, 189, 193, 225, 237, 241, 243, 251, 258, 264, 269, 272, 274, 290, 291, 293, 317, 318, 320, 326, 328, 330, 344, 347, 352-54, 359, 260, 364-66, 373, 376, 389, 396, 397, 399, 436, 446, 457, 459, 460, 477, 478, 479, 501, 508, 519, 532, 536, 538, 539, 546, 560, 567, 583, 585, 587, 590, 623, 624, 632, 644, 659, 661, 758, 790, 819, 821; and becomes President of USSR Academy of Sciences, 287, and death of, 849, and formation of OKB-52, 228, and gets second Hero of Socialist Labor, 284, and origins of Buran, 835-36; and proposals for reorganization of space industry, 205-06, 208-09; and response to Apollo 8, 677-78, and role in ASTP, 793-94, and saves Chelomey, 438-40, and selection of Voskhod crew, 414-18, and Soyuz 11 accident investigation, 782-85; and space station announcements in 1969, 712-13, and termination of original L3 project, 761-64, and use of secrecy, 169
 Kemurdzhian, Aleksandr L., 529, 530
 Kennedy, John F., 296, 297, 309, 311, 313, 333, 337, 396, 400, 401, 404, 408, 497, 554, 651, 653, 694, 711, 782, 857
 Kennedy Space Center, 643
 Kerimov, Kerim A., 284, 459, 629, 631, 632, 634, 647, 671, 701, 724, 727, 763, 773, 781, 805, 813, and appointment as Chairman of State Commission for Soyuz, 570, and appointment as Chief of Third Directorate of CURVO, 212, and appointment as Chief of TsUKOS, 380, and crew

change on Soyuz 11 776-77 and demotion of 833 and latter-day work 845 and Soyuz precursor missions 571 76 and Soyuz 1 mission 576-90

FKA 21 camera 779

KGB 166 268 453 568 587 814 852

Khachatryan Aram 1b

Kharchev Vasily 1 29

Kharkov 4 257

Khayfits N A 300

Khidirin I 621

Khilov training device 248

Khimki 17 30 46 76 125 300 315 319 388 437 530 831

Khlebtsevich Yu S 529

Khomyakov Mikhail S 163

Khristianovich Sergey A 107 125 222

Khronichev Machine Building Plant 299-300 305 438-39 539 769 771 806 810 813 827 844 and space station decision in 1969 718-22 see also Plant No 23

Khronichev State Space Scientific Production Center 126 462 840 843

Khrunov Yevgeniy V 246 247 261 363 364 451 454 509 567 568 577 579 581 588 632 684 770 and selection for Soyuz 415 630 31 and Soyuz 4/5 mission 669-74

Khrushchev Nikita S 16 53 110 114 117 119 122 124 149-51 156 159 161 175 178 179 180 210 211 220 224 233 237 239 241 256 281 282 285 287 295 299 304 305 309 311 314 373 377 396 399 405 413 423 432 443 445 447 480 538 549 552 591 601 699 721 855 857 858 and approval of first piloted spaceflight 255 56 270 and commitment to space program 408 426-27 and cooperative lunar project 400-01 and death of 428 and debate over R 9 and R 1b ICBMs 214 19 and decision on Vostok group flight 351-52 and early meetings with Chelomey 234-35 and fall of Chelomey 436-46 and favoritism for Chelomey 229-30 314 and gets third Hero of Socialist Labor 284 and influence of 177 and Korolev Glushko split 330 397-98 and only visit to Tyura Tam 418-21 and origins of Voskhod 384-86 and overthrow of 426-28 and Pitsunda meeting in 1962 322-24 and public responsibility for space program 295 and selection of Gagarin 272 and setting of launch date for Vostok 2 mission 292 and Soviet decision to go to Moon 397-98 403 and Sputnik (1) launch 167-68 and Sputnik 2 launch 171-72 and timetable for first piloted spaceflight 265 and Vostok 314 mission 354 60 and Vostok 516 mission 368

Khrushchev Sergey N 167 229 235 305 310 394 398 400 403-04 419 427 442 645-46

Kiev Aviation Institute 21

Kiev Institute of Civil Aviation Engineers 685

KIK ground tracking network 262 63 380 and establishment of 162 and expansion of 534-38 and sea based networks 703-04

Kirichenko Nikolay K 121 218

Kirilenko Andrey P 433 645 719 827 842

Kirillin Vladimir A 222

Kirillov Anatoliy S 275 276 368 536 563 574

Kisunko Grigoriy V 314

Kiwi nuclear rocket project 318

Klein Bodungen 29 35 55

Kleyenov Ivan T 7-9, 12, 13; and arrest of, 10-11

Klimov Vladimir Ya 218

Klimov design bureau see OKB 117

Klimuk Petr I 610, 657 806 and Soyuz 13 mission 817-18

Klippel Alfred 55

Klyuchi ground tracking station 162, 262, 453

Kobzarev Aleksandr A 233

Kolodin Petr I training for *Salyut/DOS-1* 770, 776-77, 785 and on Soyuz 11 accident 785-86

Kolomiitsev Ordinar P 623

Kolpashevo ground tracking station 263, 278

Koltunov Ya I 85

Kolumb lunar base 764

Kolyako Yakov P 338, 487

Kolyrna 12, 13 15 16 40

Komarov Vladimir M 246, 249 352 353, 356 422 551-52, 569 607, 609 611 613, 620 622, 660 669, and background of 568 and Soyuz 1 mission 576-90; and Voskhod crew selection 415-18 and Voskhod (1) mission 423-26

Komarova Valentina Ya (Valya) 582 588

Korneta (dog) 259

Kometa missile, see KS 1 Korneta missile

Kompressor Plant 46, 549

Komsomolskaya pravda newspaper 624

Kondratyuk Yuriy V (Aleksandr Shargey) 2, 4, 475, 799

Konopatov Aleksandr D 592 615, 687 825

Konoplev Boris M 78 134 259

Konovalev Yuriy 20

KONRID engine selection system for NI 731

Kontakt radar system 340 492 494 497 639, 701, and plans for Earth orbit tests 722-23 804, 817

Konvas camera 294

Korabl-Sputnik (1) mission 251-52

Korabl-Sputnik 2 mission 253-54

Korabl-Sputnik 3 mission 259

Korabl-Sputnik 4 mission 265-66

Korabl-Sputnik 5 mission 267, 268

Korabl-Sputniks 263

KORD system on NI rocket 325 393-94 486, 682, 683 684 692 729, 755 819 825

Korolev Sergey P 22 25 26 28 34 43-45, 47, 49-50 53-55, 57-61, 63, 66-68, 69-71, 73-81 84-86 89-91 92 93, 95, 97-100, 103-07, 110-15 116 120, 121, 123, 124 129 132-35, 137 139-44, 146, 152 153 155, 156, 157 179, 182, 186-90, 192, 193, 195 196, 198-200 203, 211 220-21 223 224, 226-28 230 233, 242, 244 246 249-51, 258, 260, 264, 265 267-68, 272, 285 287 289 290-92, 293, 295, 301-03, 306, 307, 311-13 326, 334 336, 337, 340, 341, 344-47, 349 350, 363 376, 377, 379 427, 429, 432-34, 436, 437, 439, 443-46, 461 462, 463 471, 472, 473 483 486, 488, 489, 492 495, 517 519, 520 521 522 536 538, 540, 547 548 549, 559 565 566 570 578, 591 594 602 624 628, 631, 645, 649 668 669, 674, 677 687 702 704, 715, 716, 722 735, 743 745 746 763, 764, 785, 790 791 795, 796 797

CHALLENGE TO APOLLO

INDEX

815. 817. 824. 831. 832. 833. 838 839 840. 841. 843. 844. 847. 848. 849. 850. 851. 852. 853. 855 856 857 858. and approval of first piloted spaceflight. 254-56 268-70; and arrest of and incarceration at Kolyma 11-14, and at OKB-SD in Kazan. 16-17; and awarded Ph.D. 176 and becomes Academician. 177; and "big space plan" of 1960, 237-41, and change to single-launch scheme for N1-13 program. 474-83, and conflict with Voskresenskiy 477-78, and conflicts over R-9 and R-16 ICBMs 212-19 and conflicts with Glushko. 108-09 130. 202 214-19, 237-38, 319-21, 328-30, 397-98; and death of 513-16; and debates over Voskhod crew selection. 413-18; and decision on Sputnik/PS-1. 154-55; and decision on Sputnik 2. 171-73 and design of Voskhod. 409-12; and early development of N1 rocket. 386-95; and early life. 3; and early options for N1 engines 314-18, and early satellite proposals. 139-51; and "extended Vostok" plans. 380-83. and first R-7 ICBM launches. 158-61 and gets first Hero of Socialist Labor. 121; and gets second Hero of Socialist Labor. 284 and in Germany, 30-32. 34-37. 39-42, and in GIRD. 4. 5. 6 7 and in RNII. 8-9; and incarceration at sharashka 14-16, and joins Communist Party. 115-16; and last days of 511-13 and liquid hydrogen engines 317-18. and meets with Stalin 60-61 87-88, and nuclear rocket engines 318; and Operation *Kedr*. 418-21; and opinion of Mishin. 853-54; and origins of LI Zond program. 497-506, and origins of Voskhod. 384-86 and personality of. 41, 116-18 and Pitsunda meeting in 1962. 322-24 and preparations for Voskhod launch. 421-23. and proposals for long-range space plans. 206-08; and proposals for reorganization of space industry 205-06 208-10; and rehabilitation for "crimes" 176; and relationship with Chelomey. 234. 394, and relationship with Khrushchev 180; and robotic lunar probes. 527-30 and role as manager. 858-59 and secrecy. 169-70, 373-74. 412-13; and Soviet decision to go to Moon. 395-408 and Spiral program 605 606. and vacation in Czechoslovakia. 412; and Voskhod (1) mission. 423-26; and Voskhod 2 mission, 448-60, and Voskhod proposals in 1965-66 506-11; and Vostok (1) mission. 274-77. 282, and Vostok 3/4 mission. 353-61; and Vostok 516 mission 365-73
- Koroleva, Kseniya 30
 Koroleva Natalya 30
 Koroleva, Nina P 116, 413, 513, 735
 Korostylev 574
 Korzhenevskiy, Eduard 783
 Kosberg, Semyon A 202, 203, 220, 254, 267 272, 301 302, 304, 315, 356, 389 469, 510, 541, 543, 545, and death of. 511
 Kosmonaut Hotel. 619, 773 776
Kosmonaut Vladimir Komarov tracking ship, 703-04, 707
 Kosmoplan spaceplane 241, 305-06, 311 313, 377 396, 429, and early conceptions of. 230-32; and project description, 307-09
 Kosmos booster 832
 Kosmos 3 mission 355
 Kosmos 5 mission 355
 Kosmos 47 mission 422
 Kosmos-57 mission 452-53
 Kosmos-59 mission. 453-54
 Kosmos110 mission 522-24
 Kosmos-133 mission 571-73
 Kosmos 140 mission 575-76, 630
 Kosmos-146 mission 562 738
 Kosmos-154 mission 563-64, 738
 Kosmos 159 mission. 640
 Kosmos-1861188 mission. 625-26, 629 657
 Kosmos-212/213 mission. 629-30 631 657
 Kosmos-238 mission. 633
 Kosmos 300 mission. 737 738
 Kosmos-305 mission 737 738
 Kosmos-345 mission 723
 Kosmos-379 mission. 735
 Kosmos-382 mission, 734
 Kosmos-398 mission 735
 Kosmos-434 mission 734-35
 Kosmos-496 mission 805 816
 Kosmos 557 mission 813-14
 Kosmos 573 mission. 815, 816
 Kosmos-613 mission. 817-18
 Kosmos 638 mission 826
 Kostikov, Andrey G 10-11, 13, 17 549
 Kosygin, Aleksey N 426, 428 432 436 437, 456 555 598 627, 628 692 703, 794
 Kotelnikov, Vladimir A 164, 794
 Kotov Pavel G, 228
 Kovtunenkov Vyecheslav M 44, 814
 Kozlov, Dmitry I. 44, 115 133 331, 521 693, 716 and rallies against Mishin 828 and Zvezda military space station. 596-99, 633-35
 Kozlov Frol R 172, 218, 255 270 272 282 287 311 321, 322, 363 396, 426, 473, 521 591 592 675 and gets second Hero of Socialist Labor. 284 and Vostok 314 mission. 354-60
 Kozlyavka (dog) 95, 181
 Kraft Christopher C Jr 193
Krasnaya zvezda newspaper 600
Krasnodar tracking ship 263 534
 Krasnogorsk Mechanical Optical Plant 94
 Krasnoyarsk-26, 349, 437, 746
 Krechet camera system 467 471
 Krechet-94 spacesuit 491, 495, 533, 647, 668, 685
 Kreslo instrument 767
 Kristall module for *Mir*, 840
 Krylov, Nikolay I., 379 380, 647, 786, 787, 790
 Kryukov, Sergey S 44, 73 121, 129 133 149, 151, 238 327 333, 338, 345 395, 397 462, 463, 476, 479, 481 487 518, 675 676 731 838 and background of. 391-92 and latter-day work. 848 and power struggle in TsKBEM. 828, and space station decision in 1969, 717
 Krzhizhanovich Power Institute 531
 KS-1 Kometa missile 227
 KS-50 combustion chamber. 99
 Kubasov, Valeriy N. 566 567 568 577, 588, 631, 805, 813, and moves to ASTP 814-15 and Soyuz 6/7/8 mission. 705-11; and training for *Salyut/DOS*. 770, 776-77, 786, 804-05

- Kugno. Eduard P. 817
 Kuklin, Anatoliy P. 657
 Kurashov, Sergey V. 515
 Kurbatov, Viktor. 155
 Kurchatov, Igor V. 87 116 326
 Kureytis, Stanislav A. 568
 Kurilo, Nikolay M. 29. 35
 Kurushin, Aleksandr A. 574. 680
 Kustanay. 425 673 700
 Kutakhov, Pavel S. 693
 Kutasin, Aleksandr I. 619 656
 Kutyrkin, Nikolay A. 154
 Kuybyshev. 218. 266. 281. 282. 294. 315 320. 330-32. 387. 388 390. 395 437 473. 508. 521. 549. 591. 596. 598. 633. 646 692. 716. 831
 Kuznetsov, Nikolay D. 218-19, 220, 238. 239. 315. 316-17, 320. 321 323. 330. 403. 485. 486. 547. 548. 638. 649. 684. 693. 732. 752. 759. 832. 837. 838. and death of. 846. and investigation into fourth NI launch. 823-24; and modified NI engines. 820-21 825-26. and NI engine development 387-88. and rising criticism of NI engines. 829-30
 Kuznetsov, Nikolay F. 513. 627. 777
 Kuznetsov, Nikolay N. 29. 33
 Kuznetsov, Viktor I. 29. 46. 47. 57. 72. 131. 155. 156. 177. 192. 201. 254. 258. 272. 289. 356. 359. 368. 397. 429. 480. 491. 504. 538. 545. 594. 704. and background of. 367 and death of. 846. and gets first Hero of Socialist Labor. 121, and gets second Hero of Socialist Labor. 284
 Kuznetsova, Tatyana D. 353 362
 Kvant module for *Mir*. 840
 Kvant-2 module for *Mir*. 840
-
- L**
-
- L1 circumlunar spaceship. 546. 554. 567. 570. 579. 588. 590. 607. 609 624. 626. 633 636. 639. 643. 648. 654. 661. 666 699-701 719 734. 748. 774. 795. 827. 857. and crews for. 657. 816 817. and deadlines for. 559-61 and design of spaceship. 556-58; and early conception of. 401-02 and end of program. 701 743. and ending plans for piloted flights. 686-87; and final conception of. 497-506 and launch in early 1969. 678-79; and launch record 738 and launches in early 1967. 561-64; and last mission 742-43 and mission profile of. 558-59 and response to Apollo 8 674-78; see also Zond program
 L1E test spaceship 639 643. 648. 676. 736. 738. and flight of 734
 L1S test spaceship. 546 648. 679. 682. 688. 730
 L2 lunar rover. 401-02 529-30
 L3 lunar landing program 401-02. 408. 463. 483. 485. 498. 556 557 560 567. 570 579. 588. 590. 607. 609. 633 636 643 658. 686-87. 697. 713-14. 715. 717. 721-22. 731. 740 743 745. 758. 759 760 761 765. 795. 796. 800. 804. 819. 828 841. 850. and comparison to LK-700 lunar lander project. 538-46; and conceptions of. 476-79; and cosmonaut training for 684-86. 816. 817; and decrees in. 554-55. and design of. 487-95; and development in 1970-71 732-34 and establishing deadlines for 553-56; and expenditures for. 838. and funding for. 714. 733; and limitations of. 756-57 and mission profile of lunar landing mission. 495-97; and move from EOR to LOR. 474-76; and plans for sequence of missions. 546-47. and preparations in 1967-69. 636-43 and problems in development of. 548; and program approved. 407; and refinements to plan. 527. 532-34. 546-47; and response to Apollo 8. 675-78; and schedule in early 1970s. 754-55. and termination of original project. 761-63. 821. 827. 832. 837
 L3M project, 765. 794. 803. 804. 822. 827 and approval of. 761-64; and design of. 759-61; and origins of 756-59. and termination of. 832. 834
 L3S payload. 680. 681. 691
 L4 lunar orbiter. 401-02
 L5 advanced lunar complex. 676
 L5 lunar rover 401-02
 L-18 flying laboratory. 606
 La-176 supersonic aircraft. 125
 La-350 cruise missile. see Burya
La Recherche Spatiale journal. 791
 Langemak, Georgiy E., 8. 12, 13; and arrest of. 10-11
 Langley Research Center, 193
 Lappo, Vyecheslav I. 167
 Lapshin, A. I. 63
 Launius, Roger D., 662
 Lavochkin, Semyon A. 16. 21. 125. 126. 127. 133. 223-24. 300. 437 530
 Lavochkin State Union Machine Building Plant. 528. 529. 530. 640. 675. 676. 764. 782. 795. 848; and development of lunar sample return spaceship. 641-43. and Luna missions in 1970-71. 737-42. see also OKB-301
 Lavrov, Ilya V. 146 152. 336 476. 478 745
 Lavrov, Svyatoslav S., 44 50 73
 Layka (dog). 173-74. 185
 Lazarev, Vasilii G. 508. 804. 805. and selection for Voskhod 414-18; and Soyuz 12 mission. 815-16
 Lebedev, Valentin V., and Soyuz 13 mission. 817-18
 Lebedev Physical Institute of the USSR Academy of Sciences see FIAN institute
 Lebedinskiy, Andrey V. 376 511-12
 Legostayev, Viktor P. 346. 471
 Lehesten. 29. 31. 34. 35. 55
 Lenin, Vladimir I. 716 722
 Leningrad. 4. 6. 9. 178. 262
 Leningrad Metallurgical Plant 137
 Leningrad State University. 779
 Leninsk. 264. 439. 625. 735
 Leonov, Aleksey A. 246. 247 363. 364. 421. 461. 506. 509. 512. 551. 563. 585. 610. 613. 615. 627. 657. 667. 669. 674. 690. 805. 813; and background of. 451; and moves to ASTP 814-15. and training for Moon program. 561. 651. 684-86. 699. and training for *Saljut/DOS*. 770-71. 776-77. 785. 786. 804-05 and Voskhod 2 mission 454-60
 Letunov, Yuriy V. 624
 Levitan, Yuriy B. 278
 Levkoy-2M instrument. 767
 Levkoy-3 experiment 818

CHALLENGE TO APOLLO

INDEX

Li-2 aircraft. 18, 711
 Lidorenko Nikolay S. 154
 Light Space Aircraft. *see* LKS
 Linkov, A.. 598
 liquid hydrogen rocket engines. 331, 388-89, 483, 548, 649, 687, 750, 757, 758, 759, 840, 847, and development of, 639, and early research on, 317-18
 Lira radar system. 804
 Lisa (dog). 95, 96, 181
 Lisichka (dog). 252
 Litvinov Valentin Ya. 570, 580
 LK lunar lander. 476, 495-97, 527, 531, 532-33, 547, 548, 647, 657, 676-77, 684, 731, 751, 754, 757, 760, 762, 765, 822, 825, and design of, 488-93; and development in 1970-71, 732-33; and Earth orbit test flights of, 735-36; and ground tests of, 640, 684-85, and termination of work on, 821
 LK-I circumlunar program. 395-96, 406, 407, 440, 442, 497-502, 539, 540, 543, 544, 594, 595, 807, and design of, 443-46
 LK-700 lunar lander. 594, 595, 807, and conception and design of, 538-46; and resurrection of, 645-46
 LKM lander of L3M lunar project. *see* L3M lunar project
 LK, reserve lunar lander. 533, 547, 676, 733, 827
 LKS spaceplane proposal, 835, 837
 LKSA camera. 816
 LL-1 "flying laboratory." 221
 Lobanov Nikolay A. 590
 Lodz (Poland). 462
 LOK lunar orbiter. 476, 495-97, 533, 547, 548, 639, 657, 676, 754, 757, 765, 795, 822, 825, and design of, 493-95; and development in 1970-71, 732, 733, and ground tests of, 640, 685, and termination of work on, 821
 Long-Duration Lunar Base (DLB). 764-66, 803, 834
 Long-Duration Orbital Station. *see* DOS
 Lovell, Sir Bernard. 358, 399
 Lovell, James A., Jr. 511, 667, 674
 Low, George M. 662, 794, 814
 Lozino-Lozinskiy, Cleb Ye., and Spiral program. 601-07, 789, and Buran, 836-37
 Luch laser weapon system. 790
 Luch solar panels. 251
 Luch-I cosmic ray detector. 630
 Luna probes. 297, 506, and far side sample return proposal, 796
 Luna 1 probe (Cosmic Rocket). 527
 Luna 2 probe (Second Cosmic Rocket). 527
 Luna 3 probe (Automatic Interplanetary Station). 200, 201, 527
 Luna 9 lander. 528-29, 530, 534; *see also* Ye-6 lander
 Luna 10 orbiter. 533-34, 640, 641
 Luna 11 orbiter. 534, 640, 641
 Luna 12 orbiter. 534, 640, 641
 Luna 14 orbiter. 640-41, 641, 642
 Luna 15 lander. 693-96, 737, 738. *see also* Ye-8-5 lander
 Luna 16 lander. 739-40, 742, 795. *see also* Ye-8-5 lander
 Luna 17 lander/rover. 740-42; *see also* Lunokhod 1 rover and Ye-8 rover
 Lunar Module (Apollo). 488, 489, 490

Lunar Orbital Ship. *see* LOK. 476
 Lunar Ship. *see* LK. 476
 Lunokhod 1 rover. 741-42, 795. *see also* Ye-8 rover
 Lutzin, Nikolay. 48
 Lyulka, Arkhip M.. 315, 317, 388, 483, 649, 677, 757, 759, 847

M

M bomber. 128
 M-1 booster. 226-27, 236, 302
 M2-F2 lifting body, 599
 M-4 bomber. 128
 M-SRD missile. 138, 151
 M-12 spaceplane. 311-12, 441
 M-40 cruise missile. *see* Buran
 M-48 spaceplane. 600, 718; and cancellation of, 235-36; and design of, 224-26
 M-69 Mars probe. 738
 M-220 computer. 614
 Magnus, Kurt. 30, 45, 55, 56
 Makarov, Dmitriy S.. 14
 Makarov, Oleg G.. 264, 566, 567, 657, 684, 690, 700, 804, 805; and Soyuz 12 mission, 815-16
 Makat ground tracking station. 162, 262
 Makeyev, Viktor P.. 115, 121, 349, 517
 Maksimov, Aleksandr A.. 158, 735
 Maksimov, Cleb Yu.. 85, 86, 139, 140, 141, 333-37, 477, 478, 745
 Maksimov, Nikolay D.. 46
 Malenkov, Georgiy M.. 34, 37, 73, 109-12, 117, 119, 122, 129, 144
 Malinovskiy, Rodion Ya. 266, 352, 373, 377, 380, 441, 481
 Malyshev, Vyecheslav A.. 110, 111, 112, 119, 122-24, 128-29, 144
 Malysheva (dog). 95, 181
 Manned Orbiting Laboratory (MOL). 590, 591, 595, 596, 607, 714
 Manned Spacecraft Center. 383, 386, 662, 663
 Manovtsev, German A.. 746
 Mars. early proposals for human flight to, 207, 210; and projects for human flight to, 333-38, and proposals in late 1960s, 677-78, 686-87, 697, 713-14, *see also* Aelita Mars project
 Mars robotic probes. 506
 Marshall Space Flight Center. 386
 Martian Expeditionary Complex (MEK). 746-51, 802; *see also* Aelita Mars project
 Mathes, Franz. 30
 McDonnell Aircraft Corporation. 193
 McDonnell Douglas. 714
 McDougall, Walter A.. 856
 McNamara, Robert S.. 312
 Meier, Otto. 55
 Melnikov, Mikhail V.. 17, 130, 202, 327, 389, 481, 488, 801, 820
 Menshikov, Valeriy A.. 690, 691
 Menzhinskiy Central Design Bureau. 3

- mercury program (NASA). 193 196. 220, 244 250. 253
 255 264-65 290. 295 297. 339 354. 373 383. 384. 469
 Mercury Mark II, 383 see also Gemini
 Messina I telemetry system 78
 Meteor I satellite 726. 779
 Mezon communications system 547
 Mi-4 helicopter 459
 Mi-6 helicopter 459 576. 630
 Mi-8 helicopter 684
 Mi-9 helicopter 684
 MiG fighters. 223
 MiG 15 aircraft 451. 628
 MiG-15UTI training aircraft. 248 361 627-29
 MiG 17 aircraft 606
 MiG 19 aircraft 246
 MiG 21 aircraft 606 628
 Mikoyan Anastas I 423. 456
 Mikoyan, Artem I 21. 112. 223 227 228 442 836 837. and
 Spiral program 599-607. 787-90
 Mil Mikhail L 189 545
 military control of Soviet missile and space programs.
 210-12 786-87 856-57 see also Strategic Missile Forces
 and TsUKOS
 Military-Industrial Commission (VPK) 122. 156. 179. 195
 208 217 219 233. 239. 250. 255. 269. 270. 287. 305
 362 378 379 383. 391. 403. 407. 414. 416. 419 425.
 473 443. 474 500 502. 505 506. 511 512. 525 530.
 559. 566. 569 577. 592. 596 613 633. 655. 722. 753.
 758. 762 763. 773. 800 801; and approves Voskhod pro-
 gram 385-86 and duties of 431-32. 434 and establish-
 ment of 178 and response to Apollo 8. 667-68 675
 Military Space Forces 847 and origins of 212; see also
 TsUKOS and CUKOS
 Ministry of Armaments 38. 46. 51. 59. 62 82 89 91 97.
 107. 109. 111 123 430 704. see also Ministry of Defense
 Industries
 Ministry of Armed Forces 48. 49. 51 53. 125 see also
 Ministry of Defense
 Ministry of Aviation Industries. 38. 46. 51 65. 107 133. 221.
 227 228 601 759 824. 830. 837 849
 Ministry of Chemical Industries 38
 Ministry of Communications Equipment Industry 46
 Ministry of Defense 89 125. 135 136 162 165 187. 241
 250 306 309 332 333. 379 393. 395 404. 440. 473.
 509 535 554 560 591 592 598. 636 716 721 806.
 830 835 836 838. 842 and control of space program.
 210-12 786-87 see also Ministry of Armed Forces
 Ministry of Defense Industries 124 152 165. 178 597, see
 also Ministry of Armaments
 Ministry of Electronics Industries. 38
 Ministry of Foreign Affairs. 736
 Ministry of General Machine Building (MOM). 479. 482 500.
 503 504 514. 520 538 545 548. 553 566 570 596
 613 623. 634 635. 644 645 655. 734 750. 758 773.
 776. 785. 800. 810. 833 838. and censures Mishin, 828;
 and formation and duties of 428-36 and formation of
 NPO Energiya 830-31; and reorganizes TsKBEM 794
 Ministry of Health 376. 508. 524. 776
 Ministry of Internal Affairs 110
 Ministry of Machine Building and Instrument Building. 38
 Ministry of Medium Machine Building. 110. 111. 119. 120
 122. 139. 677
 Ministry of Radio-Technical Industry. 165
 Ministry of Ship Building Industries. 38
 Mir data recorder. 783
 Mir space station 132. 248 376 527. 567. 618 722 802.
 807. 840 843. 845. 853
 Mir-3 data recorder 471
 Mirnyy launch site. 549. see also Plesetsk
 Mishin Vasily P.. 17. 20. 21. 43-45. 49. 50 59. 60 73. 85.
 86 90 91 105 113 129-31. 133 141. 152 155 159.
 171 177. 217 219. 238. 272. 313. 315. 326. 333 361
 372. 384. 390. 391. 392 397 403 447. 461 475 479 481.
 492 498. 501. 514 515. 527. 539 546. 547. 548. 549.
 553 554. 555. 557. 561. 591. 642. 665 668-69. 671
 686-87. 688. 699. 709 734. 786 787 797 799 806 810
 815 818 840 848 857. and Aelita Mars project 750-51
 and agreement with Chelomey on space station 5 808-09
 and ballistic missile defense 790-91 and becomes
 Academician 519-20 and cancellation of Voskhod pro-
 gram 522-27. and cancellation of Zvezda. 633-35. and
 crew change on Soyuz 11 776-77 and debate over
 engines in early 1970s 825-26. and DOS station plan-
 ning. 769-70; and DOS-1/Satyut launch 772-73 and
 early life of. 19; and end of NI-L3 832-33 838. and fired
 as Chief Designer 830-32; and first LI launches in 1967
 561-64; and first NI launch 679-84 and fourth NI
 launch 822 and gets Hero of Socialist Labor. 121, and
 health of 692; and in Germany 28 31. 35 37 41 42 and
 investigation into fourth NI launch. 823 24. and
 Kosmos 557 mission 813-14; and I3 development in
 1967-68. 636-43. and L3M lunar project. 757-64; and
 last LI circumlunar mission. 742-43. and latter-day life of.
 851-54; and MOKIMKBS. 799-801. 803. and new pro-
 jects in 1973-74. 826-27 and opposition against.
 827-29. and personality of 326-27. 518-19 644-45 and
 plans for fourth NI launch. 820-21; and plans for Soyuz
 in 1969. 701-03; and preparations for first DOS launch.
 770-72; and preparations for NI launch in 1968 643-51;
 and reorganizes TsKBEM 794-95. and response to Apollo
 8. 674-78 and second NI launch 688-93 and selection
 of civilian cosmonauts 566-69 and Soyuz precursor mis-
 sions in 1966-67 569-76; and Soyuz precursor missions
 in 1967-68 624-26 629-33 and Soyuz 1 mission
 576-90; and Soyuz 2/3 mission. 657-62; and Soyuz 10
 mission 774-76 and Soyuz 11 mission 780-85; and
 space station decision in 1969 714-22 and succeeds
 Korolev. 517-21 and suspected in West as Chief
 Designer. 791; and third NI launch 755-56 and work on
 NI in 1969-71 729-33. 736-37 and Zond missions in
 1967-68 610-22 and Zond 5 mission 653-57
 Missile Forces of Strategic Designation see Strategic Missile
 Forces
 Mittelwerk plant 27. 28. 35 55
 MK 700 Mars spaceship. 751-54
 MKBS. 677-78. 716 729 766. 799-801 and description of
 801-03
 MMK-I instrument. 778

INDEX

MMZ Zenit, and Spiral project. 601-07 787-90 835 837
 see also OKB-155

Mnatsakanyan, Armen S. 366 453. 470. 492. 571. 573. 639. 659

MOK station complex. 716, 809. 827 830 and background to 799-801 and description of. 801-03, and termination of 832

MOL, see Manned Orbiting Laboratory. 590

Molniya booster 130 488 640. see also 8K78 and 8K78M

Molniya-1 satellite. 381 506. 511, 525. 703. 706 816

Molotov Vyecheslav M. 37 121 149

Montania Plant. 35

Moon early proposals for human flight to 207 and early proposals for human landing on. 399. 401. and program approved 407 and Soviet decision to go to 395-408. see also L3 program

Morozov Viktor P. 287

Morya-1 ocean reconnaissance satellite. 473

Morzhovets tracking ship. 534

Moscow Aviation Institute. 19, 90. 353. 461. 851. 854

Moscow State University 19 460. 816. 845

Moskalenko, Grigoriy M. 85 86 140

Moskalenko, Kirill S. 258. 269 272-74. 332. 377

Moskvitin, A. 531

Mozhayskiy Academy. 340

Mozzhorin Yuriy A. 138, 162, 270. 285. 286. 291 429. 477 478. 480. 481. 554. 675. 676. 678. and death of 845-46 and fate of N1 rocket 819, 829-30, and role in press reports 696-97

MP-1 spaceplane 310 311

Mrykin Aleksandr G. 25 147 155, 156, 157, 188, 211-12 256. 330 365

MTKVP reusable ship 835

Mueller George E. 637

Mukha (dog) 173

Muller Rudolf 63

Multirole Orbital Complex, see MOK

Multirole Space Base Station, see MKBS

Munnich Karl. 55

Mushka (dog). 259

Myasishchev, Vladimir M. 14 112 126-28, 133 223-27, 242. 301, 302 521 599. 600. 606. 718. 837. and fired from OKB-23 235-36; and NPO Molniya. 836

N

N1 booster 80, 130, 303 333. 334. 336. 337 338. 350. 373. 377 381. 420 521, 529. 611 657 752 758. 765. 794. 795. 799 800 802 803 839 841, 846 850. 851 857 858 859. and "all-up" testing. 392; and approval of. 331; and changes made because of switch to single-launch profile. 474-83; and circumlunar proposal, 498-501; and comparisons with UR 700 538-46; and debates over engines and early design. 319-33; and decision to go to Moon. 396-408; and defense of draft plan 328-31 and design changes in 1971-72. 819-20 and design of. 483-87; and destruction of rockets. 838; and development in 1967-68 636-43 and development in 1969-71, 729-33, 736-37; and development of launch complex 393 549-50 and

draft plan signed 327. and early conceptions of. 314-17 and engines for. 387-88; and expenditures on 552-53 643-44 838, and fate of its Chief Designers. 848 and first launch of. 679-84; and ground testing of. 477-78 and improved N1 vehicles. 649-50, 676. 677 750 and initial specifications. 328 and investigation into fourth launch. 823-24; and KORD system. 325; and lack of funding. 394-95 478-79. 733 and military missions. 332-33, 790-91 and new engines for in early 1970s. 824-26; and origins of. 236-41 and plans in 1973-74 827. and preparations for launch in 1968 643-51 and problems in development in mid-1960s. 546-49 554-56 and problems in early development of. 386-95, 481; and profile for fourth launch 821 and program canceled 832-34 837, and program suspended 830-31 and publicly revealed. 852-53 and response to Apollo 8. 674-78; and rising criticism of 829-30 and second launch of 688-93 701 729-30 754 and third launch of. 754-56. 780 818-19 and U.S. intelligence on 550-51 636-37, 647 792-93 822

N1 R&D theme 97-99 101 102

N1F booster 759-61 802

N1F-V2 booster. 649

N1F-V3 booster. 649-50, 676 677. 750

N1F-V4 booster 649-50 676

N1 L3 program see L3 program

N1M booster. 750 757

N2 booster. 240, 319 and early development of 314-17

N2 RGD theme 97 101 102

N3 RGD theme 97 102-09

N-4 satellite 439-40 see also Proton satellite

N11 booster. 327-28 482 758-59 and approval of. 331 and circumlunar project 443. 498-501

N111 booster 327-28, 482 and approval of. 331

Nadiradre, Aleksandr D. 228-29

Narr, Anton. 81

NASA. see National Aeronautics and Space Administration

National Advisory Committee for Aeronautics. 192 209

National Aeronautics and Space Administration (NASA).

179 203. 250. 258. 263. 265. 295 296. 299, 325. 331. 354. 383. 389. 397 399 408. 443. 446. 460 475. 483 488 502 511 522 525 526. 535. 540. 541. 551 553. 562 565. 599 623. 629. 631. 636. 637. 639 648 650 651 658. 662 682. 684 687. 688. 694. 695 702. 714. 724. 734. 740 751 757 759 765. 770. 782. 796. 804. 810. 813 814, 818. 835 839. and astronauts. 245 363. 415, 624. and cooperation with Russians. 840 and cooperation with Soviets. 793-94 and decision on Apollo 8. 662-63, and decision to go to Moon. 296-97 and formation of. 192, 193 209

National Air and Space Museum. 854

NATO see North Atlantic Treaty Organization

Navaho missile. 106

Nedelin, Mitrofan I. 36-37 87 88. 105. 121, 124 133-36.

155. 156 157. 159 165. 215. 251. 273. 377. 426 and appointed as Commander of Strategic Missile Forces 211 and R-16 disaster. 256-58

Nedelin disaster. see R-16 disaster

NEK. see Scientific-Experimental Complex

- Nelyubov, Grigoriy G. 246, 247, 249, 261, 272-74, 291, 352, 353 and background, 262, and dismissal and death of 374-75
- Neman Iosif G. 14
- NERVA nuclear rocket project, 318
- Nesmeyanov, Aleksandr N. 141, 142, 165
- Nesterenko, Aleksey I. 39, 67, 88, 102, 135, 136, 155, 156
- Nevel tracking ship, 534
- Newsweek* magazine, 666
- New York Times, The, 89, 285, 373-74, 515, 550, 620, 712, 792, 794
- NIEI PDS institute, 198, 340, 413, 472, 524, 589-90
- NII-1 institute, 17-21, 22, 25, 26, 28, 29, 46, 47-48, 51-53, 66, 76, 79, 98, 99, 101, 106, 107, 125, 127, 130, 177, 189, 200, 225, 226, 304, 309, 318, 331, 339, 389, 467, 823, 849 see also Scientific-Research Institute for Thermal Processes
- NII-1 Branch No. 2, 63, 65
- NII-2 institute (of Ministry of Aviation Industries), 309
- NII-2 institute (of Air Defense Forces), 598
- NII-3 institute, 10-13, 15, 17, 30, 44, 63, 68, 90, 200; see also RNII
- NII-4 institute, 39, 48, 65, 66, 68, 75, 84, 85, 88, 89, 102, 103, 124, 134, 135, 138, 139, 141, 142, 144, 149, 151, 152, 162, 183, 186, 212, 262-63, 270, 277, 278, 287, 325, 331, 364, 372, 535, 536, 537, 582, 618
- NII-10 institute, 46, 72, 131, 367
- NII-20 institute, 46, 78
- NII-49 institute, 78
- NII-88 institute, 38-39, 43-46, 48, 49, 50, 54, 56-58, 63, 65, 66, 68, 71, 73, 76, 78, 81-83, 85, 90-92, 94, 98, 99, 101, 104, 105, 107, 113-117, 119, 121, 123, 125, 129, 130, 133, 139, 141, 150, 151, 178, 212, 258, 285, 286, 309, 331, 339, 364, 429, 462, 471, 477, 480, 530, 675, 704, 795, see also TsNII Mash
- NII-88 Branch No. 1, 45, 80, 82
- NII-88 Branch No. 2, 58, 83, 137
- NII-125 institute, 90, 199
- NII-137 institute, 259
- NII-229 Institute, 258, 331, 389, 483; see also Scientific-Research Institute for Chemical Machine Building
- NII-380 institute, 353, 411, 450
- NII-627 Institute, 487, 594 see also All-Union Scientific-Research Institute for Electromechanics
- NII-642 institute, 227
- NII-648 institute, 340, 366, 453, 470, 471, 492, see also Scientific Research Institute for Precision Instruments
- NII-695 institute, 201, 226, 272, 274, 471
- NII-885 institute, 46, 78, 91, 99, 131, 200, 201, 331, 471, 503, 504, 536, 704, 705, see also Scientific-Research Institute of Radio Instrument Building
- NII-944 institute, 201, 258, 367, 429, 480, 594
- NII RP institute, 340
- NII TekhnoMash, 732
- NII Yaf institute, 56, 69, 407
- NII P 5 launch range, 135, 136, 138, 157; see also Tyura-Tam
- Nikitin, Nikifor, 135
- Nikitin, Nikolay K., 247, 365
- Nikolayev, Andrian G., 246, 247, 249, 261, 274, 291, 292, 352, 353, 363, 370, 378, 568, 577, 580, 588, 607, 631, 674, 703, 779, and background of, 356, and Soyuz 9 mission, 723-29; and Vostok 314 mission, 356-61; and wedding of, 373-74
- Nikolayeva, Elena, 726
- NIP-16 ground tracking station, 536, 582, 703 see also Yevpatoriya
- NITI 40, 331, 732
- Nitochkin, Aleksey A., 135, 136
- Nixon, Richard M., 765, 794
- NK-9 engine, 316-17, 322, 387, 388, 482, 486
- NK-9V engine, 322, 387, 388
- NK-15 engine, 387, 388, 479, 485, 486, 548, 644, 692, 730, 731
- NK-15V engine, 387, 485, 547, 649, 731
- NK-19 engine, 387, 487
- NK 21 engine, 387, 485, 731
- NK 31 engine, 825, 825
- NK-33 engine, 820, 825, 837, 846
- NK-35 engine, 752
- NK-41 engine, 825
- NK-43 engine, 820, 825, 846
- NKVD secret police, 10-15, 18, 19, 258
- NORAD, see North American Air Defense Command
- Nordhausen, 24, 27, 29, 32, 34, 35, 40, 56
- North American Air Defense Command (NORAD), 232
- North American Aviation, 397
- North Atlantic Treaty Organization (NATO), 102
- Nosov, Aleksandr I., 155, 157, 166
- Nova heavy boosters, 541, 751
- Novikov, Aleksandr A., 21
- Novikov, Mikhail A., 266
- NPO Energiya, 833, 834, 839, 848, and acquires Chelomey's Fili Branch, 842, and Energiya-Buran program, 836, and formation of, 830-31, and work in 1970s and 1980s, 839-41; see also OKB-1 and TsKBEM
- NPO Mashinostroyeniya, 843, see also OKB 52 and TsKBM
- NPO Molniya, formation of, 836-37
- NPO Trud, 846, see also OKB-276 and KB Trud
- nuclear power sources, 335, 749-50
- nuclear rocket engines, 318, 389, 482, 677, 752, and discussions about, 208, and early proposals for, 207
- Nudel'man, Aleksandr E., 594, 596

O

- Oazis-1 greenhouse, 778
- Oazis-2 greenhouse, 818
- Oberth, Hermann, I., 4, 716, 799
- Object A warhead, 151
- Object B warhead, 151
- Object D satellite, 149, 150, 151, 152, 154, 155, 162, 164, 172, 180, 186, 187, 191; and goals of, 153, and instruments on, 175, and launches of, 175-76 see also Sputnik 3
- Object G warhead, 151
- Object K Kosmoplan, see Kosmoplan

INDEX

- Object K spaceship. 193–95, 205, 210, 221, 225, 226, 232, 235, 240, 244; and design of. 195–201; and renamed Vostok. 250. see also Object OD-2 satellite and Vostok spaceship
- Object KL spaceship. 240
- Object KMV spaceship. 240, 333
- Object KS spaceship. 240
- Object MV tracking station. 536
- Object OD-1 satellite. 187
- Object OD-2 satellite. 187, 188, and design of. 189–92, 193–95
- Object R Raketoplan, see Raketoplan
- Object V warhead IS1
- Obraztsov (Academician) 609
- OD-4 viewfinder, 767
- OD-5 viewfinder, 593
- Ogorodnikov, Kirill F. 146
- OKB-1 (Korolev), 90–91, 104, 107, 108, 113, 115, 120, 121, 125, 129, 130, 133, 137, 138, 146, 149, 159, 160, 161, 162, 172, 175, 178, 183, 185, 186, 187, 189, 190, 195, 197, 198, 200–03, 208, 209, 212, 220, 224, 225, 236, 238, 239–41, 243, 248–50, 252, 255, 256, 259, 264, 266, 273, 285, 309, 319, 321, 324–27, 329, 331, 332, 351, 355, 363, 364, 370, 377–79, 414, 417, 429, 434–45, 462, 463, 472, 473, 474, 511, 512, 513, 514, 517, 521, 529, 536, 538, 602, 745, 764, 848; and decision to pick successor to Korolev. 517–21; and design of. 152; and design of N1. 483–87; and design of post-Vostok spaceship. 337–45; and design of Voskhod. 409–13; and early development of N1 rocket. 386–95; and "extended Vostok" plans. 380–83 and L3 lunar landing program. 474–83 and lack of money. 383, 395, 404, and projects for Mars missions. 333–37, and renamed TsKBEM. 520, and selection of N1 engines. 314–18; and separation from NII-88. 151–52; and size of. 290, 437, and Soviet decision to go to Moon. 395–408, and Soyuz circumlunar project. 345–50, and Voskhod 2 mission. 448–60, and Voskhod proposals for 1965–66, 506–11. see also TsKBEM and NPO Energiya
- OKB-1 Branch No. 2. 437
- OKB-1 Branch No. 3. 331, 437, 469, 473, 508, 521, see also TsKBEM Branch No. 3
- OKB-2 (Isayev). 102, 199, 217, 315, 340, 388, 389, 429, 466, 495, 531, 548, 768, 795, and separation from NII-88. 200, see also Design Bureau of Chemical Machine Building
- OKB-3 (Sevruk), 114
- OKB-4 (Bisnovat), 836
- OKB-10 (Reshetnev), 349
- OKB-12 (Abramov), 331
- OKB-16 (Nudelman), 594
- OKB-23 (Myasishchev), 126, 128, 133, 223–26; and attached to OKB-52. 235–36, 242, 299–300, 718. see also OKB-52 Branch No. 1
- OKB-36 (Kolesov), 604
- OKB-51 (Sukhoy), 235, 236
- OKB-52 (Chelomey), 229–32, 305, 307, 308, 309, 310, 312, 344, 393–94, 395, 407, 419, 420, 429, and end of conception of L1 Zond project. 497–506; and expansion of. 299–300, and fall of Khrushchev. 436–46; and formation of. 228, and projects in early 1960s. 313, and renamed TsKBEM. 520; see also TsKBEM
- OKB-52 Branch No. 1, 236, 301, 302, 303, 439, see also TsKBEM Branch No. 1
- OKB-52 Branch No. 2. 299–300
- OKB-52 Branch No. 3. 300, 437
- OKB115 (Yakovlev), 64
- OKB-117 (Izotov), 545
- OKB-124 (Voronin) 199, 264, 271, 472, 490, 524; see also KB Nauka
- OKB-154 (Kosberg). 202, 220, 301, 315, 389, 429, 469, 511, 524, 525, 541, 592, 752. see also Design Bureau of Chemical Automation
- OKB 155 (Mrkoyan), 223, 227, 442, and work on Spiral spaceplane. 599–607, see also MMZ Zenit
- OKB-156 (Tupolev), 126, 128, 236, 415, 599, 600, 605
- OKB-165 (Lyulka), 315, 388, 389, 487. see also KB Saturn
- OKB-240 (Ilyushin), 721
- OKB-256 (Tsybin), 221–23
- OKB-276 (Kuznetsov), 218–19, 220, 236, 315, 316–17, 326, 331, 387, 390, 393, 395, 485, 547, 548; see also KB Trud
- OKB-300 (Tumanskiy), 340, 488
- OKB-301 (Lavochkin), 125–26, 133, 223–24, 300, 437–38, 530, see also OKB-52 Branch No. 3 and Lavochkin Machine Building Plant
- OKB-329 (Mil), 189, 340
- OKB-456 (Clushko), 46, 50, 57, 76, 100, 109, 129, 201, 217, 258, 303, 315, 318, 329, 331, 481, 613, see also KB EnergoMash
- OKB-482 (Myasishchev), 126
- OKB-586 (Yangel), 114, 164, 212, 214, 241, 492; see also KB Yuzhnoye
- OKB-670 (Bondaryuk), 107, 125, 318
- OKB-692 (Konoplev), 257–58
- OKB MEI (Bogomolov), 155, 172, 175, 201, 340, 411, 421, 820
- OKB-SD (Clushko), 16, 17, 21, 22, 30, 46
- Okhapkin, Sergey O., 50, 73, 121, 133, 151, 152, 327, 391, 395, 397, 479, 554, 580, 634, 638, 644, 716, 794, 821, 827, and background of. 521; and death of. 848, and demotion of. 833, and gets Hero of Socialist Labor. 177; and power struggle in TsKBEM. 828; and space station decision in 1969. 717
- Okhotsimskiy, Dmitriy Ye., 103, 641
- Operation *Bereza*, 229–30
- Operation Kedr, 418–21, 427
- Operation *Ost*, 29–30
- OPM MIAN, 75, 102, 103, 105, 139, 141, 161, 177, 187, 189, 344, 353, 849
- Organization of Soviet space industry, description of. 284–90; and proposals for. 205, 206, 208–10, 428–36
- Orion-1 telescope, 766, 768, 778, 818
- Orion-2 telescope, 817, 818
- Orlan spacesuit, 493, 647, 668
- OSK-4 optical instrument, 597
- Osoaviakhim, 4, 6
- OSTI telescope, 767, 773, 778
- Ostashev, Arkady I., 44, 256
- Ostashev, Yevgeniy, 256

Osvoyeniye lunar base. 764
OTK technical commission in Germany. 28. 29-37, 40, 41, 49
O'Toole, Thomas. 784
Ozerov, Georgiy A. 16

P

P 5 naval cruise missile 228-29 721
P 6 naval cruise missile 241
P 70 Ametist naval cruise missile 437
Pacific Ocean Hydrographic Expedition No 4 263
Paine, Thomas O. 663 793
Pallo, Arvid V. 17 25 29 31 198 260
Pallo, Vladimir V. 719
Parin, Vasily V. 93 173 291 376 620
Pashinin, Mikhail M. 224
Pashkov, Georgiy N. 40 123 129 139 142 146 147 155
156 305 06 446 547 655
Patrick Air Force Base 153
Patsayev, Viktor I. 684 799 818 and becomes primary crew
for Soyuz 11 776-77 and reconstruction of Soyuz 11
accident 783 84 and Soyuz 11 mission 777-81 785
and training for Salyut/DOS 1 772
Paton, Boris Ye. 486 623 710
Paton Institute of Electro Welding 331 486 623 702
Pavlov, Aleksandr P. 121
Pchelka (dog) 259
Pe 8 bomber 22
Peenemunde 18 24-27 30 32 35 42 51 55 56 75 83
Peleng beacon system 197 201
Peoples Commissariat of Ammunitions 33
Peoples Commissariat of Armaments 30 33 37
Peoples Commissariat of Aviation Industry 20 22 25 33
Peoples Commissariat of Heavy Industry 7
Peoples Commissariat of Internal Affairs see NKVD
Peresypkin, Ivan 156
Pershing missiles 844
Pervukhin 149
Petlyakov, Vladimir M. 14 218
Petrov, Boris N. 740 750 814
Petrov, Georgiy I. 79 189 586 770 and appointment to
Institute of Space Research 436
Petrovich, G. (pseudonym for Glushko) 791
Petrovskiy, Boris V. 514
Phillips, Samuel C. 662 663
Physical Power Institute 335 389
PIK ground tracking network 156-57
piloted spaceships approval of 193 and early design of
189 92 and early work on 186-89 see also Object OD
2 satellite Object K spaceship and Vostok spaceship
Pilyugin, Nikolay A. 19 28 29 34 35 39 46 47 57 72
78 99 120 131 155 156 157 159 166 177 192 200
201 237 254 272 289 331 356 359 393 403 429
439 453 459 486 491 510 519 558 676 677 704
820 851 and background of 503-05 and becomes
Academician 519 20 and death of 846 and gets first
Hero of Socialist Labor 121 and gets second Hero of
Socialist Labor 284
Pingvin spacesuit 725 767 780

Pitsunda. 281, 304. and meeting in 1962. 322-24. 330
PKA spaceplane. 225. 226. 338. 448. 600. and design of
221-22. 223
Planeta radar. 489. 491 496. 639
Plant No 1 (in Germany) see Design Bureau Olimpiya
Plant No 2. 218
Plant No 2 (in Germany), see Montania Plant
Plant No 3 (in Germany), see Zentralwerke
Plant No 4 (in Germany) see Sonderhausen
Plant No 16 15. 16
Plant No 18 223
Plant No 19 613
Plant No 22 462
Plant No 23 126 224. 235-36 242 see also Khrunichev
Machine Building Plant
Plant No 51 23, 227
Plant No 66. 115
Plant No 8 196. 340. 410. 469. 471
Plant No 84 46
Plant No 88. 38. see also Experimental Machine Building
Plant (of TsKBEM)
Plant No 166. 606. 787
Plant No 293, 17, 19
Plant No 385, 115
Plant No 500. 227
Plant No 586 97. 113. 285 431
Plant No 642. 299
Plant No 918, 172, 181, 198, 264 267. 340. 362. 472 490.
509. 511 and Voskhod 2 airlock. 448-50. see also KB
Zvezda
Platform ground test system 471
Plesetsk. 72. 549; see also Mirnyy
Plotnost instrument. 767. 778
Pobedonostsev, Yuriy A. 5. 6. 7 8. 13. 18. 19. 28. 29. 32. 34.
44. 45 53 59. 81. 85 90. 115 199
Podgorniy 628
Poisk newspaper. 852
Pokrovskiy, Aleksey V. 93
Poland. 18 31
Polet 1 satellite 394
Polkarpov, Nikolay N. 22 112
Polinon-2M instrument. 767 778
Politburo 36. 109 110 129. 149 177 178. 180 213 270.
385. 423. 428. 433. 517. 598. 703 724. 831. 832 844. 849
Poyakov, Boris I. 414
Polyakov, Valeriy A. 840
Polyarniy, Aleksandr P. 76. 99
Ponomareva, Valentina L. 353. 362. 365 366 369. 509
Popkov, Ivan V. 512
Popov, Vitaliy I. 93
Popovich, Pavel R. 246. 247. 249. 261. 267. 274 352. 353.
363. 378 563 581 598 610. 613. 615. 616. 627 653.
655. 667. 717. 811. 813; and background of. 356 and cap-
corn on Vostok (1) mission 275-76 277, and Soyuz-VI
program. 636. and training for Moon program. 561 657
and Vostok 314 mission. 357-61
Potopalov, Aleksandr V. 836
Potsdam conference 36
POU 11 instrument. 593

CHALLENGE TO APOLLO

INDEX

Powers, Francis Gary. 253
Pravda newspaper. 168, 169, 295, 529, 791, 846
 Presidium. *see* Politburo
 Priboy life support instrument. 593
 Priroda module for *Mir*. 840, 843
 Progress M spaceship. 840
 Progress Machine Building Plant. 315, 331, 390, 549, 598, 646
 Progress spaceship. 826, 839
 Project Starfish. 357
 propellants. debates over. 212-19, 320-21, 327, 328-30
 Proton booster. 130, 440, 487, 541, 542, 548, 550, 559, 560, 563, 591, 610, 612, 615, 616, 621, 639, 641-42, 654, 665, 666, 679, 681, 687, 688, 693, 718, 719, 734, 741, 742, 748, 773, 793, 802, 811, 812, 813, 824, 835, 840, 843, and summary of poor launch record in 1967-70, 738-39; *see also* UR-500 and UR-500K boosters
 Proton satellite. 440
 Prudnikov, Ivan S. 44, 488, 576
 PS-1 satellite. 154-55, 160, 172, 175, 180; and design of. 161-64 and launch of. 166-68; and permission to launch. 165; *see also* Sputnik
 PS-2 satellite. 154-55, 174, 175, 180; and design of. 171-73; *see also* Sputnik 2
 Putilov, Aleksandr I. 14

R

R-020 high-speed aircraft. *see* RSR high-speed aircraft
 R-1 missile. 41, 49, 53, 56, 57, 58, 72-76, 78, 79, 83, 85, 86, 93, 94, 96, 100, 101, 109, 113, 118, 172, 180, 183, 538, and approval of. 61; and description of. 50, and launches of. 61-62, 71
 R-1 Raketoplan. 441-42, 599, 600
 R-1A missile. 70, 71, 94
 R-1B missile. 94-97, 180, 182, 183
 R-1D missile. 180-81
 R-1M missile. 113
 R-1V missile. 94-97, 180
 R-1Ye missile. 151, 180, 181-82, 185
 R-2 missile. 42, 49-50, 59-61, 63, 68, 72, 74-76, 78, 79, 85, 86, 97, 100, 103, 113, 118, 143, 152, 172, 183, 185, 192; and description of. 57-58, and launches of. 72-73; and sent to China. 290
 R-2 Raketoplan. 441-42, 599, 600
 R-2A missile. 172, 185, 186, 250
 R-2E missile. 72, 76
 R-2R missile. 138
 R-3 missile. 73-80, 81, 84-86, 97-99, 101, 103, 105, 108, 125; and approval of. 73, and cancellation of. 105, 111-12, and description of. 78
 R-3A missile. 78-79, 98, 99, 101
 R-5 missile. 99, 114, 119, 143, 172, 192, and description of. 99-100; and launches of. 100-01, 115, 120
 R-5A missile. 151, 250
 R-5M missile. 124, 128, 151, 858, and launches of. 120, 149
 R-5R missile. 138, 151
 R-5V missile. 506
 R6-117 engine. 444

R-7 ICBM. 128, 129, 130, 135-43, 147, 149-51, 154, 156, 163, 173, 175, 179, 180, 186, 187, 195, 199, 201, 202, 206, 210, 211, 215, 221, 223, 224, 236, 240, 251, 256, 276, 277, 307, 308, 319, 332, 364, 394, 402, 473, 488, 495, 499, 500, 549, 567, 605, 659, 735, 832, 855, 857, and declared operational. 213; and design of. 131-33, and launches of. 157-61, 213
 R-7A ICBM. 251, 469, and declared operational. 213
 R-9 ICBM. 238, 240, 272, 316, 321-323, 327, 381, 388, 391; and origins and debate over. 214-19
 R-9A ICBM. 217, 328, 418, 421, 832
 R-9M ICBM. 316, 322
 R-9V ICBM. 217
 R-11 missile. 102, 106, 114, 115, 118, 119, 126
 R-11FM missile. 151, 195
 R-11M missile. 120, 151, 195
 R-12 missile. 114, 127, 164, 211, 212, 215, 232, 310, 311, 323, and BOR spaceplanes. 788-89
 R-14 missile. 211, 212, 215, 232, 308, 323
 R-16 disaster in 1960. 256-58, 275, 319, 367
 R-16 ICBM. 418, 707, 796, 832, and conflicts over. 214-19, 256-58
 R-36 ICBM. 323, 418, 419, 482, 796, 832
 R-36M ICBM. 796, 832
 R-36-O orbital bombardment system. 323, 324, 482
 R-56 booster. 323, 324, 333, 402-03, 406, 408, 539, 796
 R-101 missile. 101
 Rachevskaya, Esfir M. 16
 Radio journal. 165
 Radio satellites. 852
 Raduga communications system. 197, 201
 Raduga Instrument. 767
 Rafikov, Mars Z. 246, 247, 374
 Raketa group. 19-21, 25, 26, 29, 46
Raketi i lyudi memoirs. 848
Raketno-kosmicheskaya tekhnika journal. 595
 Raketoplan spaceplane. 305-06, 313, 377, 395, 396, 443, 445, 540, and early conceptions of. 230, 232, 241-42, and project. 308-12; and termination of. 440-42, 599
 Range Measurement Complex. *see* PIK
 Raushenbakh, Boris V. 252, 262, 273, 340, 355, 370, 458, 469, 507-08, 573, 575, 580, 582, 584, 585, 740 and background of. 200, 792, and evaluation of Korolev. 858-59; and leaves TsKBEM, 814; and name revealed, 791-92, and space station decision in 1969, 717
 Razumikhin, B. 85
 RD-012U ramjet engine. 126
 RD-018A ramjet engine. 127
 RD-040 ramjet engine. 107
 RD-0105 engine. 202, 203, 259
 RD-0108 engine. 422, 469
 RD-0109 engine. 203, 259, 277
 RD-0110 engine. 469
 RD-0215 engine. 541
 RD-0225 engine. 592
 RD-0410 nuclear engine. 752
 RD-1KhZ engine. 16
 RD-2 engine. 16
 RD-3 engine. 16

- RD-36-35K turbojet engine, 604
 RD-100 engine, 46, 50, 57, 58, 79
 RD-101 engine, 57, 100
 RD-103 engine, 100
 RD-105 engine, 109, 129
 RD-106 engine, 109, 129
 RD-107 engine, 130
 RD-108 engine, 130, 137
 RD-109 engine, 202
 RD-110 engine, 76, 98, 99, 304, 329
 RD-111 engine, 218, 219, 238, 329
 RD-211 engine, 114–15, 127
 RD-212 engine, 127
 RD-213 engine, 127
 RD-253 engine, 303, 316, 320, 329, 388, 439, 480, 543, 548, 751, 824; and UR-700M booster, 751–52
 RD-254 engine, 316, 320, 542, 543
 RD-270 engine, 479, 480, 751; and UR-700 booster, 541–46
 RD-410 nuclear engine, 752
 RD-858 engine, 493
 RD-859 engine, 493
 RDKS-100 engine, 53
 Reactive Scientific-Research Institute, see RNII and NII-3
 Rebrov, Mikhail F., 850
 Regulus missile, 229
 Reikhrudol, Ye., 70
 Reusable Vertical-Landing Transport Craft, see MTKVP
 Reutov Mechanical Plant, 228
 Rezeda-2M instrument, 767
 Rezeda-5 experiment, 778
 Rheinmetall-Borzig company, 35
 Rheintochter, 40
 Rifma spectrometer, 741
 Ristna tracking ship, 534
 RKK Energiya, 44, 567, 840, 845, 848; see also NPO Energiya
 RL-10 engine, 759
 RNII institute, 7–10, 15, 16, 19, 45; see also NII-3 institute
 Romanov, Aleksandr P., 111
 Roshchin, Vladimir F., 338, 339
 Rosselevich, Igor A., 471
 Rotor training device, 248
 Rozenplenter, Gunther, 28
 RP-318 rocket-plane, 9, 11, 13
 RS high-speed aircraft, 221
 RS-132 rocket, 49
 RSR high-speed aircraft, 221, 222
 RSS-1 spectrograph, 672
 RSS-2 spectrograph, 710, 726, 779, 818
 RT-1 missile, 381
 RT-2 ICBM, 381, 645, 658
 RT-2PLU ICBM, 794
 RT-4 telescope, 767, 810
 RTS-9 telemeasurement system, 768
 Rubin trajectory measurement system, 197, 201, 768–69
 Rudenko, Sergey I., 356, 365, 373, 417, 418, 422, 459, 567, 629
 Rudnev, Konstantin N., 91, 113, 146, 155, 178, 180, 193, 210, 215, 217, 264, 269, 284, 285, 332, 359, 585; and background of, 179; and becomes Chairman of State Commission for Vostok, 258; and gets Hero of Socialist Labor, 284; and Vostok (1) mission, 271–75
 Rudnitskiy, Viktor A., 28, 31, 35
 Rudolf, 63
 Rukavishnikov, Nikolay N., 657, 684, 690, 785; and Soyuz 10 mission, 774–76; and training for *Salyut*/DOS-1, 770, 772
 Ryabikov, Vasilii M., 34, 37, 58, 91, 123, 124, 129, 142, 147, 148, 155, 157, 158, 159, 160, 165, 166, 167, 168; and appointment as Chairman of State Commission for Sputnik, 156; and death of, 845
 Ryazanov, Yevgeniy F., 147, 152
 Ryazanskiy, Mikhail S., 28, 35, 46, 47, 57, 78, 92, 109–10, 131, 134, 146, 154, 155, 156, 167, 177, 192, 201, 254, 272, 275, 289, 330, 331, 429, 453, 471, 503, 504, 505, 536, 562, 573, 611, 675, 676, 727; and background of, 704–05; and death of, 846; and gets Hero of Socialist Labor, 121
 Rybinsk Design Bureau of Engine Building, 604
 Ryzhaya (dog), 186
 Ryzhik (dog), 181
 Ryzhikh, Mikhail I., 718, 719
-
- S**
-
- S1.5400 engine, 329
 S2.1100 engine, 126
 S2.1500 engine, 126
 S2.253 engine, 102, 106
 S5.5A engine, 528
 S5.35 engine, 466, 673
 S5.53 engine, 558
 S5.61 engine, 642, 739
 S5.66 engine, 768
 S-75 missile system, 253
 Sadovskiy, Igor N., 801
 Sagdeyev, Roald Z., 623
 Sakhalin tracking ship, 263
 Sakharov, Andrey D., 116, 117, 128, 129, 377
 SALT talks, 432
 Salyut-1 computer, 614
 Salyut (1) space station (DOS-1), 795, 803, 809, 840, 845, 853; and crews for, 770–71, 772; and launch of, 773–74; and naming of, 773; and reentry of, 785; and Soyuz 10 mission, 774–76; and Soyuz 11 mission, 777–82; see also DOS space station
 Salyut 2 space station, 811–12, 814
 Salyut 3 space station, 841
 Salyut 4 space station, 827, 839
 Salyut 5 space station, 841
 Salyut 6 space station, 827, 839, 848
 Salyut 7 space station, 840
 Samoylov, Valeriy Ye., 234
 Sänger, Eugen, 32, 53
 Sänger-Bredt bomber, 32, 48, 65, 73, 74, 76, 79, 80, 107, 127, 225, 232, 606; and description of, 51–53
 Sarafanov, Gennadiy V., 811
 Sarychev, Vasilii A., 103
 Sary-Shagan launch range, 162, 198, 224, 262
 Saturn I booster, 397, 406

INDEX

- Saturn IB booster. 502. 553
 Saturn C-5 booster. 331, 332. 386. 541
 Saturn V booster. 325. 386–87. 382. 397. 420. 475. 481. 482. 483. 497. 499. 502. 543. 551. 553. 611. 636. 637. 643. 644. 646. 648. 649. 651. 662. 714. 824. 840
 Schmetterling missile. 32. 40
 Schmidt, T.. 45
 Schwartz, R., 45
 Scientific-Experimental Complex (NEK). 749
 Scientific-Research and Experimental Institute of the Parachute Landing Service, *see* NIEI PDS
 Scientific-Research and Testing Range No. 5. *see* NIIP-5 and Tyura-Tam
 Scientific-Research Institute for Applied Mechanics. 491. 594: *see also* NII-944
 Scientific-Research Institute for Automated Devices. 624. 629. 665, *see also* NIEI PDS
 Scientific-Research Institute for Chemical and Construction Machines, 640
 Scientific-Research Institute for Chemical Machine Building. 638, *see also* NII-229
 Scientific-Research Institute for Current Sources. 154
 Scientific-Research Institute for Nuclear Physics, *see* NII YaF
 Scientific-Research Institute for Precision Instruments. 571. 639. 659. 711. 772. *see also* NII-648
 Scientific-Research Institute for Thermal Processes (NII TP). 541. 752. 823: *see also* NII-1
 Scientific-Research Institute of Automation and Instrument Building. 429. 439. 486. 491. 504. 505. 677. 820
 Scientific-Research Institute of Digital Electronic Computing Technology. 558
 Scientific-Research Institute of Machine Building. 768
 Scientific-Research Institute of Measurement Technology. 823
 Scientific-Research Institute of Radio Instrument Building. 429. 505. 704. *see also* NII-885
 Scott, David R., 609
 Scud-B missile. 102
 Seamans, Robert C., 383
 Second Chief Directorate of the USSR Council of Ministers. 111
 Second Territory, of OKB-I. 195. 462
 secrecy in Soviet space program. 169–70. 791–92. 795, and loosening of during *glasnost*. 852–53
 Secretariat of the Central Committee of the Communist Party. 177–78. 179
 Sedov, Leonid I., 145. 148. 151. 169. 412. 610. 661. 662. 667. 697. 711
 Seliger TV system. 172
 Semenov, Anatoliy I., 19. 20. 25. 211–12
 Semenov, Yuriy P., 827. and background of. 719. and power struggle in TsKBEM. 828, and space station decision in 1969. 719–22
 Semlchastnyy, V., 453
Semyon Chelyuskin transport ship. 742
 Serbin, Ivan D., 233. 272. 300. 314. 373. 416. 515. 554. 568. 590. 611. 675. 770
 Serebrov, Aleksandr. 840
 Seregin, Vladimir S., 376. 627–29
 Sergeyev, K., pseudonym for Korolev. 169
 Serov, Ivan A., 38. 42. 51. 54–56. 62
 Seryapin, Aleksandr D., 93. 183
 Sevastyanov, Vitaliy I., 615. 616. 657. 666. 667. 703. 708. 806, and Soyuz 9 mission. 723–29
 Seventh Chief Directorate of Ministry of Armaments (or State Committee for Defense Technology). 38. 54. 61. 188. 428. 704
 Sever spaceship. 338–45. 348. 465, and space station. 344
 Severin, Gay I., 448–50. 452. 490. 491. 509. 561. 580. 587. 632. 640. 647. 727. 785
 Sevruk, Dominik D., 114
 Shabarov, Yevgeniy V., 44. 137. 166. 168. 256. 458. 518. 611. 616. 619. 654. 830; and power struggle in TsKBEM. 828
 Shabranskiy, Vitaliy L., 31. 35
 Shakespeare. 425
 Shakhurin, Aleksey I., 18. 20–21. 33
 Shargey, Aleksandr, *see* Kondratyuk, Yuriy V.
 Shatalov, Vladimir A., 375. 522. 524. 657. 658. 685. 779. 792. 805. 817; and background of. 669. and replaces Kamanin as Air Force aide for space, 804–05; and Soyuz 415 mission. 669–74; and Soyuz 61718 mission. 703. 705–11; and Soyuz 10 mission. 774–76; and training for *Salyut/DOS-1*. 772. 773
 Shcheulov, Viktor I., 677
 Sheffer, Ursula. 58
 Sheldon, Charles S., 822
 Shepard, Alan B., Jr., 295. 296. 351
 Sheremetyevskiy, Nikolay N., 683
 Shishkin, Oleg N., 823
 Shonin, Georgiy S., 246. 247. 249. 352. 353. 509. 631; and preparations for Voskhod 3. 522–24; and Soyuz 61718 mission. 705–11; and training for *Salyut/DOS-1*. 770. 772
 Shor, Yakov B., 67
 Shparkasse group, 35
 Shternberg Astronomical Institute, 742
 Shtokolov, Vladimir A., 66. 68
 Shubnikov, Georgiy M., 135. 136. 512
 Shuster, Petr A., 601
 Shustin, Konstantin S., 189
 Shutka (dog). 259
Sibir tracking ship. 263
 Signal communications system. 196. 201. 425. 524
 Simferopol, 262. 640. 642
 Sinilshchikov, Yevgeniy V., 40
 Sirobaba, Yakov Ya., 811
 Sisakyan, Norair M., 93. 188. 291. 524
 SKB-385. 115. 349. 517
 SKB-567. 536
 SKB Biofizpribor. 172
 Skylab program. 714. 770. 793. 802. 804. 811. 815. 818. 839. and competition with Soviets, 810. and launch of. 813–14
 Slayton, Donald K. (Deke), 415. 796
 Smelaya (dog). 95
 Smirnov, Leonid V., 285. 291. 293. 311. 314. 320–21. 363. 373. 386. 407. 408. 420. 425–27. 499. 500. 501. 509. 525. 526. 545. 547. 553. 554. 560. 561. 611. 618. 620. 631. 632. 634. 682. 699. 701. 703. 714. 728. 750. 786. 797. 800. 803. 824; and background of. 431–34; and end of NII-L3 project. 832–34; and latter-day career. 844. and on-

gins of Buran 835 and Soyuz 1 mission. 577, and Vostok 3/4 mission 354-61

SMK-4 sextant. 705. 706

SMK-6 sextant 726

Sochi. 171. 291

Sokol (SK-1) spacesuit. 198-99, 265. 274

Sokol-K1 spacesuit. 785. 804. 805. 816

Sokolov, Andrey I. 25. 26. 32. 39. 61. 124

Soldatova, Lidiya N. 85. 139. 140

Solovyev, Yuriy D. 130

Solovyeva, Irina B. 353. 362. 366. 369. 509

Sommerda. 35

Sonderhausen. 35. 39. 42

Sorokin, Aleksey V. 414-15. 508

Sotsialisticheskaya industriya newspaper 773

SODU see System of Orientation Motion and Control

Soviet Air Defense Forces, 375. 393. 431. 728. 781. 786. 790

Soviet Air Force. 21. 24. 51. 90. 173. 183. 220. 222. 227. 262. 287. 291. 306. 312. 352. 354. 363. 374-76. 381-383. 403. 425. 431. 441. 459. 479. 481. 506. 507. 508. 509. 510. 572. 574. 576. 586. 606. 607. 614. 623. 624. 625. 632. 650. 679. 684. 718. 728. 770. 773. 781. 796. 816. 817. and debates over Voskhod crew selection 413-18; and resistance to civilian cosmonauts. 565-69, and selection of 1960 cosmonauts. 243-49; and struggle to control space program 377-80. 786-87

Soviet Army 628. 680

Soviet Navy, 228. 230. 243. 375. 431. 536. 561. 786

Soviet News journal. 666

Soyuz booster. 130. 401. 502. 605. 769. see also 11A511

Soyuz circumlunar project. 345-50. 355. 358. 373. 375. 377. 380-82. 384. 386. 395. 402. 405. 406. 409. 443. 445. 461. 497. and approval of 383, and cancellation of. 407. see also 7K spaceship. 9K rocket blok. and 11K spaceship

Soyuz spaceship/program 64. 402. 461. 465. 492. 493. 494. 495. 497. 498. 501. 502. 504. 513. 522. 526. 527. 535. 546. 556. 557. 560. 561. 562. 564. 565. 567. 590. 607. 613. 614. 622. 675. 715. 717. 766. 768. 769. 772. 779. 786. 795. 801. 802. 807. 810. 815. 816. 817. 839. 840. 857. and decisions over piloted missions in 1968. 631-33 and design of. 463-73, and docking system of. 471; and early stage of project 345-50; and launch escape system of 469 and plans for missions in 1972. 805-06 and precursor missions in 1966-67. 571-76, and precursor missions in 1967-68. 624-26. 629-30, and precursors to. 337-45; and preparations for flight in 1966. 569-71; and redesign for two cosmonauts 783. 785, and rendezvous system of. 469-71 and variants in the early 1970s. 804. 810. see also 7K-OK spaceship and 7K-T spaceship

Soyuz 1 mission, 597. 609. 610. 622. 625. 629. 631. 632. 657. 669. 814. 827. and actual mission. 581-88; and crews for. 568-69, and investigation of 588-90; and preparations for. 576-81

Soyuz 213 mission 657-62. 757. 827

Soyuz 415 mission. 675. 678. 680. 701. 703. 729. 770. and actual mission 668-74

Soyuz 617/8 mission. 723. 726. 727. 757. 777. 827. and actual mission. 705-11; and plans for. 701-02

Soyuz 9 mission 771. and actual mission, 724-29; and background to. 722-24

Soyuz 10 mission. 774-76. 791. 827

Soyuz 11 mission. 796. 799. 803. 804. 805. 814. 818. 827. and accident investigation. 782-86, and actual mission. 777-81

Soyuz 12 mission, 816

Soyuz 13 mission. 817-18

Soyuz-P anti-satellite spaceship. 473

Soyuz-R reconnaissance spaceship. 473. 591. 597. 635

Soyuz-T spaceship, 826. 839

Soyuz-TM spaceship. 826. 840

Soyuz-VI military station program, 633-36. 716; and termination of. 722

spaceplanes, early research on. 220-23. 224-27; see also PKA. M-48. Raketoplan. Kosmoplan. and Spiral

Space Shuttle (NASA). 414. 793. 835-37 and decision to build 765-66

space stations. decision to build in late 1960s 677-78. 686. 697. 713-22

Space Task Group at Langley Research Center 193

Special Committee for Armaments for the Army and Navy 146. 147. 155. 156. 165. and formation of. 122-23

Special Committee for Reactive Technology. 37-38. 40. 50. 51. see also Special Committee No 2

Special Committee No 2. 51. 53. 55. 73. 80. 97. 105. 107. 109. 111. 117. 122. 177. 367

Special Committee on the Atomic Bomb. 36

Special Design Bureau No. 1 see OKB-1

Special Experimental Design Bureau of the Flight Research Institute. 467. 490. 614. 650

Special Purpose Brigade of the Supreme High Command Reserve. 39

Special Technical Commission in Germany, see OTK

Spektr module for *Mir*. 840. 843

Spiral spaceplane program. 442. 473. 836. 841; and design of. 602-07 and end of. 835. 837 and origins of. 599-602; and work in late 1960s. 787-90

Spiridinov, Aleksey S. 63. 150

Spitsa, Ivan I. 535

Sputnik (1) 171. 173. 220. 224. 242. 243. 295. 297. 314. 318. 330. 335. 350. 406. 408. 421. 482. 512. 653. 694. 791. 845. 847. 852. 855. 858. 859 and design of. 161-64; and launch of. 166-68; and origins of 154-55 and per mission to launch. 165 and press release for. 168; see also PS-1

Sputnik 2 174. 185; and design of. 171-73, see also PS-2

Sputnik 3. 176. 191. 421; see also Object D

SR Raketoplan. 308

SR-71A Blackbird. 221

SS-1 missile. see R-1 missile

SS-2 missile. see R-2 missile

SS-3 missile. see R-5 and R-5M missiles

SS-4 missile. see R-12 missile

SS-5 missile. see R-14 missile

SS-6 missile. see R-7 missile

SS-9 missile. see R-36 missile

SS-10 missile. see UR-200 missile

SS-11 missile. see UR-100 missile

CHALLENGE TO APOLLO

INDEX

- SS-18 missile, *see* R-36M missile
- SS-20 missile. 229
- Stafford, Thomas P. 782
- Stalin, Iosif V.. 10, 14, 16, 19, 21-24, 33, 36, 37, 51, 53, 57, 60, 64, 65, 68, 73, 74, 86, 87, 91, 112, 117, 119, 126, 140, 176, 227, 367, 442, 462, 705, 855, 858 and death of. 100, 109-10
- Star City, *see* Zvezdnyy Gorodok
- State Central Test Range No. 4, *see* GTsP-4
- State Commission for A-4. 54-55
- State Commission for Almaz. 811
- State Commission for LI. 560-61, 687, 845, and in 1969, 678-79, 701, and launches in early 1967, 561-64, and launches in late 1967 and early 1968, 610-22; and Zond 5 mission. 653-57
- State Commission for Luna landers. 694-96, 737, 739-42
- State Commission for NI. 826, and first launch. 679-84; and fourth NI launch. 822-24, 830, and second launch. 692, and third launch. 820
- State Commission for R-1. 61
- State Commission for R-5. 121
- State Commission for R-7. 155-56, 157, 159, 161, 164, 165, 179
- State Commission for R-16. 256
- State Commission for *Salyut*. 771, 773, 774, 776, 777, 780, 781, 785
- State Commission for Soyuz. 570, 571, 572, 624-26, 629-33, 668, 670, 701, 816, 833, 845, and Soyuz I mission. 576-90, and Soyuz 2/3 mission. 657-62, and Soyuz 9 mission. 723-29
- State Commission for Sputnik. 165, 166, 167, 845
- State Commission for Voskhod. 422, 426, 431, 451, 845, and Voskhod 2 mission. 454-60
- State Commission for Vostok, 251, 253, 258, 260, 264, 283, 291, 355, 845; and Vostok (1) mission, 268-75, 282, and Vostok 3/4 mission. 356-61, and Vostok 5/6 mission. 364-70
- State Committee for Aviation Technology. 220, 222, 225, 233, 255, 379, 415, 429
- State Committee for Defense Technology. 178, 179, 188, 255, 257, 284, 285, 287, 291, 320, 332, 354, 364, 379, 393, 429, 430, 463
- State Committee for Radio Electronics. 255, 429
- State Committee for Ship Building. 255, 429
- State Committee for the Coordination of Scientific Research. 285
- State Committee for War. 21
- State Institute for Applied Chemistry. 202
- State Institute for Reactive Technology. 17
- State Red Banner Scientific Research Institute of the Air Force. 568, 669
- Stechkin, Boris S. 15
- Steinhoff, Ernst. 28
- Stels radar system. 470
- Stepanov, Vladimir C.. 488, 491
- Strategic Missile Forces. 251, 258, 263, 264, 269, 287, 301, 306, 330, 332, 363, 368, 381, 383, 389, 431, 457, 479, 509, 570, 625, 677, 679, 706, 723, 724, 731, 796, 813; and control of ground communications network. 535-38, and formation of. 211-12, 235, and struggle to control space program. 377-80, 786-87, and transfer of men to Ministry of General Machine Building. 434-36
- Strelka (dog). 253
- Stroganov, Boris A.. 553, 675, 680
- Struminskiy, Vladimir V.. 222, 602
- suborbital piloted program (1980s). 183-85
- Suchan tracking ship. 263
- Sukhoy, Pavel O.. 16, 235, 604, 836
- Suslov, M.. 697
- Svinets experiment. 522, 597, 702, 707, 780
- Syromyatnikov, Vladimir S.. 346, 471
- System of Orientation Motion and Control (of Soyuz spaceship). 469, 471

T

- T1 R&D theme. 107-09, 125, 128
- T1 test spaceship. 639-40, 643, 676, 734
- T2 R&D theme. 107, 109, 125
- T2 test spaceship. 639-40, 643, 676, and description of. 735, and flights of. 734-36
- T-4 experimental aircraft. 836
- Tabakov, Cleb M.. 58, 258, 482
- Taman* rescue ship. 742
- Taran anti-ballistic missile system. 313, 438
- Taratynova, Galina P.. 103
- TASS (news agency). 168, 251, 269, 270, 278, 369, 515, 563, 571, 575, 587, 616, 625, 685, 696, 706, 735, 740, 741, 812
- Tayga hypersonic program. 606
- Tayga stations. 156
- TB-5 bomber. 4
- Tbilisi ground tracking station. 262
- TBK-12 training chamber. 248
- TBK-60 barometric chamber. 451, 452
- TDK-1 spaceship simulator. 249
- TDK-2 spaceship simulator. 352
- TDK-3TD spaceship simulator. 451
- TDK-3V spaceship simulator. 415
- TDU-1 engine. 197, 200, 251, 252, 259, 261, 265, 279, 411
- TEB telescope. 767, 778
- Tereshkova, Valentina V., 353, 362, 369, 381, 396, 397, 508, 674, 726; and selection of for flight. 365; and Vostok 5/6 mission. 365-73; and wedding of. 373-74
- Thagard, Norman E.. 840
- thermonuclear weapons. *see* hydrogen bomb
- Third Chief Directorate of the Ministry of General Machine Building. 430, 570, 634, 833
- Third Chief Directorate of the USSR Council of Ministers. 111, 123
- Third Directorate of CURVO. 212, 284, 380
- Thor missile. 355
- Tikhomirov, Nikolay I.. 6
- Tikhonravov, Mikhail K.. 5, 6, 8, 13, 18, 19, 22, 27, 48, 49, 63-66, 75, 87, 103, 124, 134, 140, 153, 154, 169, 180, 183, 185-87, 199, 201, 210, 267, 269, 327, 335, 338, 529, and death of. 847; and design of first piloted spaceship. 189-92; and early satellite studies. 84-86, 88-81, 139-44, 146-51, and launch vehicle studies in late 1940s. 66-68.

and moves from NII-4 to OKB-I 152; and proposals for long-range space plans. 206-08; and secrecy, 169-70

Tishkin, Anatoliy P. 828

Titan IICBM 217, 302

Titan IIC booster. 590

Titov, German S. 246, 247, 249, 261, 271-74, 296, 314, 319, 351, 352, 354, 356, 357, 370, 372, 412, 413, 627, 667, 693, and background of. 262, 291; and Spiral. 606-07; and Vostok (1) mission preparations. 274-76, and Vostok 2 mission. 292-95

Tkachev, Fedor D. 198, 356, 472-73, 524, 587, 589, 629, 632, 727

TKS spaceship, see Transport-Supply Ship

TMK Mars spaceship. 334-37, 745-46

TMK-I Mars spaceship. 334, 399

TMKB Soyuz. 488, 491

TNA-400 communications dish, 640

Tokaty-Tokayev, Grigoriy A. 53

Tolstoy, Aleksey N. 745

Tomilin, Arkadiy S. 188

Tonomer instrument, 767

Topaz camera system. 196, 424, 450

Topaz radio control system. 78

Topchiyev, Gennadiy V. 147

TOS space station. 337, 715-16, see also Zverda station

Tral telemetry system. 155, 157, 172, 175, 573

Tral D telemetry system. 175

Tral-PI telemetry system. 197, 201

Tral-T communication system. 197

Tral-IP telemetry system. 421, 422

Transport-Supply Ship (TKS) 595, 809, 841, 844, and approval of. 806 and design of. 807

Tregub, Yakov I. 327, 537-38, 576, 578, 582, 644, 650, 724, 734, 775, 785, 813, 821, 827; and fired from TskBEM. 814

Tritko, Karl I. 43, 90, 91

Trubachev, Pavel. 155

Trufanov, Yuriy N. 616, 654

Truman, Harry S. 87

TsAGI institute. 4, 48, 103, 126, 222, 236, 309, 339, 599, 600, 602, 606, 787, 789

TsAKB. 195

Tsander, Fridrikh A. 3, 4, 5, 6, 9, 208, 333

Tselinograd. 630

Tsetsior, Yevgeniy M. 29

TsIAM institute. 21, 53, 79, 91, 106, 309, 541, 692

Tsiklon booster. 832

Tsiolkovskiy, Konstantin E. 1-2, 4, 7, 8, 27, 66, 74, 89, 150, 182, 205, 206, 208, 215, 317, 333, 337, 404, 475, 512, 686, 716, 799, 851, and 100th birthday of. 165

TskB-29. 14, 15

TskBEM. 520, 527, 537, 539, 561, 563, 607, 623, 665, 676, 677, 685, 700, 742, 743, 755, 764, 783, 790, 791, 809, 810, 815, 817, 821, 848; and Aelita Mars project. 746-51; and becomes part of NPO Energiya. 830-31; and cancellation of Voskhod program. 522-27; and conception of LI circumlunar project. 556-61; and decision on space station in 1969. 714-22, and development of NII-L3 complex in 1967-68. 636-43 and DOS design. 769-70; and finances. 549, and Kosmos-557 mission. 813-14, and LI launches in 1967-68. 610-22; and L3M project. 758-64; and MOK/MKB5 station. 801-02, and new projects in 1973-74. 826-27; and organization of. 520-21, 794-95; and power struggle within. 827-29; and preparations for first DOS launch. 770-72, and preparations for NII launch in 1968. 643-51 and problems in NII-L3 development in mid-1960s. 546-56, and selection of civilian cosmonauts. 565-69, 669, 724, and Soyuz precursor missions in 1966-67. 569-76; and Soyuz precursor missions in 1967-68. 624-26, 629-33; and Soyuz 1 mission. 576-90 and Soyuz 213 mission. 657-62; and Soyuz 5 accident. 673-74; and Soyuz-VI program. 633-36; and termination of original L3 project. 761-63 and work on NI in 1969-71. 729-33, 736-37; see also OKB-I

TskBEM Branch No. 3. 591, 646, 716-17; and Zvezda military space station. 596-99, 633-35, see also OKB-I Branch No. 3

TskBM. 520, 716-18, 738, and Aelita Mars project. 750-54; and Almaz 1/Salyut 2 mission. 810-12; and cosmonauts from. 717; and UR-7001LK-700 program. 538-46, and work on TKS. 806-07; see also OKB-52

TskBM Branch No. 1 (at Fili). 539, 752, 769, 843; and becomes part of NPO Energiya. 842, and development of TKS. 806-07, and space station decision in 1969. 718-22, see also OKB-52 Branch No. 1

TsNII-30 institute. 463

TsNII-50 institute. 847

TsNII-58 institute. 195

TsNIIIMash institute. 537, 552, 554, 618, 637, 655, 675, 678, 684, 696, 819, 829, 845; see also NII-88

TsPI-31 Institute. 135

TsUKOS. 435, 634, 655 and becomes CUKOS. 786-87; and formation of. 380

Tsybin, Pavel V. 220-23, 225-27, 302, 338, 448, 573, 580, 587, 599, 600, 601, 615, 636, 650, 769, 837

Tsygan (dog). 95, 96

Tsyganka (dog). 181

Tu-2 bomber. 15

Tu-16 bomber. 223, 630

Tu-95 bomber. 128, 218, 263, 600, 605, 788

Tu-95K carrier aircraft. 837

Tu-95KM carrier aircraft. 605

Tu-104 aircraft. 248, 361, 451, 452, 610, 806

Tu-104L aircraft. 375

Tu-114 aircraft. 218

Tu-124 aircraft. 615

Tukhachevskiy, Mikhail I. 7, 8, 10, 11

Tupolev, Andrey N. 3, 14-16, 21, 92, 126, 218, 415, 521, 604, 605, 837 and spaceplane research. 599-601

Tushino Machine Building Plant. 837

Tveretskiy, Aleksandr F. 39

Typhoon missile. 32

Tyulin, Georgiy A. 19, 20, 25, 26, 27, 29, 31, 32, 35, 39, 49, 142, 258, 285, 369, 417, 422, 451, 457, 459, 518, 536, 560, 563, 566, 570, 621, 647, 678, 687, 701, 737, 741; and background of. 364-65; and death of. 845, and LI program. 610, 615, 616, 618, 619, 655, 657, and Luna 15 mission. 694-96; and Luna 16 mission. 739-40 and

CHALLENGE TO APOLLO

© 1997 by NASA

NASA SP-4001-87-001-1

INDEX

Voskhod program cancellation. 522-25, and Vostok 516 mission. 366-70

Tyulpan launch pad. 131-32

Tyura-Tam launch range. 135-38, 153, 156, 157, 159, 162, 165, 168, 173, 174, 223, 251, 252, 256, 261, 262, 264, 266, 271-75, 277, 282, 292, 319, 325, 331, 332, 349, 355, 357, 365, 366, 394, 413, 417, 418, 422, 426, 427, 431, 453, 454, 458, 460, 477-478, 480, 482, 495, 512, 525, 528, 532, 537, 555, 559, 560, 561, 562, 563, 571, 573, 575, 578, 579, 582, 583, 584, 585, 586, 611, 613, 615, 619, 621, 625, 629, 636, 643, 646, 648, 649, 653, 659, 663, 666, 667, 668, 675, 678, 681, 693, 705, 707, 723, 724, 737, 754, 771, 772, 776, 780, 813, 822, and construction of 135-37; and construction of NI complexes. 393, 549-50, 755, control site at. 535-36 and creation of Baykonur name. 284 and description of. 439; and Operation Kedr. 418-421; and second NI launch. 688-93; and selection of. 133-34; see also NIIP-5

Tyurin, Petr A., 648

U

U-2000 engine. 101

Udarov, Grigoriy. 155, 156

Ugolek (dog). 523-24

Ulan-Ude ground tracking station. 263

Ulrikh, Vasily V., 12

Ulybyshev, Boris N., 746

Umpfenbach, Joachim. 30, 35, 45, 58, 63

United Nations. 256, 400, 401

UPMK, see Cosmonaut Maneuvering and Motion Unit

UR-100 ICBM. 313, 539, 540, 545, 602, 603, 718

UR-200 ICBM. 234-35, 242, 302-05, 308, 311, 313, 322, 393-94, 439, 445, 541, 600, 718; and cancellation of. 418-20, 436-37; and description of. 301

UR-500 booster. 311, 313, 320, 322, 333, 388, 407, 419-20, 438, 443, 445, 499, 500, 545, 549, 718; and approval for, 324, and development of. 439, and first launch of. 440, and origins and design of. 302-05; see also Proton booster

UR-500K booster. 530, 532, 541, 546, 548, 554, 591, 610, 639, 679, 687, 701, 743, 840, and L1 launches in early 1967. 561-64; and L1 launches in 1967-68. 611-22 and LK-1 project. 443-46 and origins of L1 Zond project. 500-06; and role in L1 circumlunar program. 556-61; and summary of poor launch record in 1967-70. 738-39; see also Proton booster

UR-700 booster. 420, 480, 481, 751, 762, 825; and conception and design of. 538-46; and resurrection of. 645-46

UR-700M booster. 751-54, 841

Ural Electromechanical Company. 495

US ocean reconnaissance satellite. 235, 241-42, 304, 307, 312, 394, 419, 540, 812-13

U S Air Force. 211, 220, 599, 606

U S intelligence on Soviet missile and space programs. 133, 205, 278, 374, 408, 432, 550-51, 620, 636-37, 647, 662, 687, 708, 734, 784, 792-93, 822

U S Navy. 229, 656

USSR Academy of Artillery Sciences. 65, 67, 69, 84, 87, 88, 93, 124

USSR Academy of Medical Sciences. 93, 244, 414

USSR Academy of Sciences. 8, 48, 71, 93, 95, 115, 141, 145-49, 152, 165, 177, 181, 182, 187, 188, 219, 228, 243, 244, 248, 255, 263, 272, 283, 287, 320, 328, 333, 353, 379, 381, 399, 431, 438, 479, 481, 497, 508, 519, 520, 535, 537, 610, 641, 677, 696, 703, 750, 763, 770, 789, 792, 795, 848, 849, 850, and cosmonauts from. 623-24 and decision to go to Moon. 401; and formation of Institute of Space Research. 436

USSR Hydrometeorological Service. 726

Ussuriysk tracking station. 561

Ustinov, Dmitriy F., 33-34, 36, 37, 40, 54-60, 62, 81, 87, 88, 90, 91, 100, 105, 109-14, 123, 124, 129, 132, 133, 141, 142, 146, 149, 164, 165, 179, 180, 210, 215, 217, 219, 250, 254, 258, 269, 285, 287, 305, 311, 314, 323, 354, 357, 363, 378, 418, 426, 430, 431, 456, 462, 480, 482, 517, 518, 539, 545, 553, 554, 555, 560, 561, 563, 577, 579, 586, 587, 590, 611, 613, 618, 620, 628, 631, 632, 633, 645, 688, 699, 701, 702, 703, 714, 730, 746, 769, 770, 771, 782, 785, 786, 797, 799, 800, 803, 804, 806, 810, 813, 824, 836, 845, 853, 858, and background of. 433-34, and becomes VPK Chairman. 178; and critical of NI. 829, and death of. 844; and end of NI-L3 project. 832-34; and firing of Mishin. 830-31; and gets second Hero of Socialist Labor. 284, and power struggle within TsKBEM. 828-29; and relationship with Chelomey. 233, 419-20, 787, 842-43; and space station decision in 1969. 715-22

Utkin, Ivan I., 471

Utkin, Viktor V., 588, 624, 626, 657

V

V-1 missile, see Fi 103

V-2 missile, see A-4

V-10 helicopter. 650

V-300 missile. 126, 200

Vakhnichenko, Vladimir V., 392

Van Allen, James. 145

Van Allen radiation belts. 523, 524

Vandenberg Air Force Base. 835-36

Vanguard project. 154, 297

Vannikov, Boris L., 33

Varlamov, Valentin S., 246, 249

Vasily Golounin ship. 656

Vasilyevskiy, Aleksandr M., 93, 139, 142

Vasilyev, Anatoliy. 155

Vasilyev, M. (pseudonym for Mishin). 791

Vavilov, Anatoliy. 24

Vavilov, Sergey I., 56

Vavilov State Optical Institute. 187

Vazhenkov, Nikolay I., 14

Vechernaya Moskva newspaper. 4

Velikhov, Yevgeniy. 313

Venera robotic probes. 506

Vernadskiy Institute of Geochemistry and Analytical Chemistry. 740

- Verne, Jules. 7
- Vernov, Sergey N., 49, 56, 69, 70, 169, 355
- Vershinin, Konstantin A., 245, 246, 269, 281, 282, 352, 363, 375, 377, 379, 441, 442, 459, 509, 651
- Vertikal-M instrument, 767
- Veterok (dog), 523-24
- Vetoshkin, Sergey I., 38, 40, 54, 58, 59, 61, 91, 110
- Vetrov, Georgiy S., 44, 237, 384, 445, 480
- VIAM institute, 127, 222, 541
- Viebach, Fritz, 55
- Viktorenko, Aleksandr, 840
- Vishnevskiy, Aleksandr A., 514
- Vladimirov, Professor (pseudonym for Barmin), 846
- Vladimirovka launch range, 223, 310, 311, 574, 614
- Vladimirskiy, Sergey, 156
- VNIИ-100 institute, 529
- Volchok simulator, 614
- Volga airlock, 448-50, 455
- Volga high-altitude tests, 815
- Volga infrared instrument, 593
- Volga river, 281
- Volga simulator, 622
- Volgograd, 54
- Volkodav, 116
- Volkov, Vladislav N., 566, 567, 799, 818; and becomes primary crew for Soyuz 11, 776-77; and reconstruction of Soyuz 11 accident, 783-84; and Soyuz 6/7/8 mission, 705-11; and Soyuz 11 mission, 777-81, 785; and training for *Salyut*/DOS-1, 772
- Volna-20 fuel cell, 495, 755
- Voloshin, Valeriy A., 610, 615, 657
- Volynkin, Yuvenaliy, 365
- Volynov, Boris V., 246, 247, 249, 353, 356, 363, 364, 366, 657, 658, 717, 770; and preparations for Voskhod 3, 522-24; and selection for Soyuz 4/5, 630-31; and Soyuz 4/5 mission, 669-74; and Voskhod crew selection, 415-18
- von Braun, Werner, 18, 24, 27, 28, 76, 81, 83, 265, 519, 687
- Vorobyev, Lev V., 817
- Vorobyev, Yevgeniy I., 727
- Voronezh, 189, 315, 389, 524
- Voronin, Grigoriy I., 199, 264, 271, 272, 356, 457, 490, 510, 523, 525, 561, 632
- Voronov, Anatoliy F., 684
- Voronov, Nikolay N., 36, 87
- Voroshilov, Kliment, 37
- Vorotnikov, V., 390
- Voskhod program, 421, 463, 471, 472, 513, 535, 565, 567, 570, 578, 590, 623, 669, 673, 674, 785, 795, 815, 816, 817, 857; and approved, 386; and cancellation of, 525-27; and debates over crew selection, 413-18; and design of, 409-13; and origins of, 384-86; and proposals for 1965-66, 506-11
- Voskhod (1) mission, 507, 510, 669; and actual mission, 423-26; and Khrushchev overthrow, 427-28; and preparations for launch, 421-23
- Voskhod 2 mission, 461, 506, 507, 508, 509, 511, 551, 561, 578; and actual mission, 454-60; and design of spaceship, 448-51; and preparations for, 446-54
- Voskhod 3 (proposed) mission, 507-11, 533, 597, 658; and preparations for, 522-27
- Voskhod 4 (proposed) mission, 507-11, 522
- Voskhod 5/6 (proposed) missions, 511, 522; see also Voskhod program
- Voskresenskiy, Leonid A., 19, 29, 31, 35, 43, 50, 121, 133, 151, 152, 155, 157, 158, 159, 166, 171, 264, 275, 276, 292, 327, 346, 368, 512, 681; and conflict with Korolev, 477-78; and death of, 478; and gets Hero of Socialist Labor, 177
- Vostok booster, 130, 202-03, 321, 381, 542; see also 8K72 and 8K72K boosters
- Vostok program, 220, 297, 334, 337, 338, 339, 341, 350, 375, 377, 384-86, 395, 409-13, 446, 448, 463, 469, 471, 477, 512, 530, 535, 565, 567, 570, 590, 673, 795, 816, 817, 857; and approval for first piloted spaceflight, 254-55; and approval of, 193; and design of spaceship, 195-201; and "extended Vostok" plans, 378-79, 380-83, 385, 447; and plans for group flight, 351-52; and plans for women flight, 362-64; and precursor missions of, 250-56, 264-68; see also Object OD-2 satellite
- Vostok (1) mission, 619; and actual mission, 276-81; and preparations for, 274-76
- Vostok 2 mission, 319, 412; actual mission, 292-95; and goals of, 292
- Vostok 3/4 mission, 364, 369, 561, 724; and actual mission, 356-61; preparations for, 353-56
- Vostok 5/6 mission, preparations for, 362-68
- Vostok 7, 8, and 9 (proposed) missions, 382-83
- Vostok 1 spaceship variant, 250, 252, 254, 255, 258-60; see also 1K
- Vostok 1P spaceship variant, 251; see also 1KP
- Vostok 3A spaceship variant, 250, 252, 254, 255, 258, 260, 264-66, 268, 271, 343; see also 3KA
- Vostok 7 spaceship variant, 342-46; see also 1L spaceship
- Voznyuk, Vasilii I., 54, 100, 133, 134
- VPK, see Military-Industrial Commission
- VR-190 missile, 64, 65, 66, 180, 185
- VR-210 missile, 49, 56, 63
- Vulkan welding instrument, 623, 702, 705; and experiment on Soyuz 6, 709-10
- Vykhod EVA experiment, 382, 386, 421, 447, 451; see also Voskhod 2 mission
- Vyshinskiy, Andrey Yu., 13
- Vystrel group, 31, 35, 40
- Vzor instrument, 196, 412, 467, 469-70

W

- Washington Post, *The*, 784, 794
- Wasserfall missile, 32, 38, 40, 101, 102
- Webb, James E., 296, 483, 551, 637
- White, Edward H., 460, 562
- White Sands, 32, 57
- Wilford, John Noble, 620, 792
- Wolff, Waldemar, 30, 45, 58, 63, 82-83
- women cosmonauts, selection of, 352-53; and proposal for second mission, 508-09, 526; and training of, 361-62

CHALLENGE TO APOLLO

X

X-15 rocket-plane. 600
 X-20A Dyna-Soar. *see* Dyna Soar
 X-24 lifting body. 835

Y

YaERD-2200 nuclear rocket engine. 389
 Yak-18 aircraft. 353
 YaKhR-2 booster. 318
 Yakovlev, Aleksandr S. 16, 21, 64, 218, 604
 Yakovlev, Nikolay D. 36, 37, 38, 40, 54, 55, 62, 91
 Yakubovskiy, Ivan I. 635
 Yangel, Mikhail K. 112, 113, 114, 115, 119, 127, 164, 230, 233, 241, 242, 306, 308, 310, 311, 314, 315, 322-24, 330, 333, 427, 432-34, 439, 482, 495, 512, 539, 684, 734, 786, 791, 832, 841, 852. and Aelita Mars project. 750. and agrees to build LK lander engine. 492. and becomes Academician. 519-20. and "civil war" over missiles. 787. and death of. 796. and gets second Hero of Socialist Labor. 284. and Operation Kedr. 418-21. and R-16 disaster. 256-58. and R-56 proposal. 323, 324, 402-03, 406, 408. and struggle over R-9 and R-16 ICBMs. 212-19. and supported by Ustinov. 787
 Yantar reconnaissance satellites. 635
 Yantar-2K reconnaissance satellite. 634
 Yastreb spacesuit. 559, 580, 668, 671
 Yatsunskiy, Igor M. 66, 68, 85, 139, 140, 141
 Yazdovskiy, Valeriy A. 817
 Yazdovskiy, Vladimir A. 92-94, 173, 183, 243, 244, 247, 253, 254, 264, 274, 291, 354, 357, 365, 372
 Ye-1 lunar probe. 527
 Ye-2 lunar probe. 527
 Ye-2A lunar probe. 200
 Ye-3 lunar probe. 527
 Ye-4 lunar probe. 527
 Ye-6 lunar lander. 511, 528, 533. *see also* Luna missions
 Ye-6LF lunar orbiter. 534
 Ye-6LS lunar orbiter. 534, 640, 643
 Ye-6M lunar lander. 528
 Ye-6S lunar orbiter. 533
 Ye-7 lunar orbiter. 528
 Ye-8 lunar rover. 541, 547, 641-43, 647, 676, 733, 738, 827. and design of. 530-33. and first launches of. 679, 681. and launches in 1971. 740-42. *see also* Luna missions
 Ye-8.5 lunar sample return spaceship. 668, 738. and design of. 641-43. and launches in 1969. 687-88, 693-96. and launches in 1970. 737-40. *see also* Luna missions
 Ye-8LS lunar orbiter. 532, 643
 Yelremov, Cerbert A. 234, 442, 443, 843
 Yelremov, Nikolay I. 7, 267
 Yefremov, Vladimir G. 200
 Yegorov, Boris B. 422. and selection for Voskhod. 414-18. and Voskhod (1) mission. 423-26
 Yegorov, Boris G. 414, 417
 Yegorov, Vsevolod A. 103, 142

Yeliseyev, Aleksey S. 566, 567, 568, 568, 577, 579, 583, 588, 632, 684, 773, 779, 792. and selection for Soyuz. 415, 630-31. and Soyuz 4/5 mission. 669-74. and Soyuz 6/1718 mission. 703, 705-11. and Soyuz 10 mission. 774-76. and training for *Saiyut/DOS 1*. 770, 772
 Yelizovo ground tracking station. 162, 262, 278, 453
 Yeniseysk ground tracking station. 162, 262
 Yerkina, Zhanna D. 353, 362
 Yershov, Valentin C. 623, 624
 Yesenin, Tolya. 168
 Yevpatoriya ground tracking station. 536-37, 572, 582, 583, 584, 586, 616, 618, 625, 629, 654, 655, 656, 659, 703, 728, 777, 779, 781, 812, 813. *see also* NIP-16
 Yezhov, Nikolay I. 12
 York, Herbert F. 237
 Yuganov, Yevgeniy M. 183, 291

Z

Zagorsk. 58, 83, 137, 138, 156, 331, 389, 483, 638, 642, 685
 Zakharov, Matvey V. 378, 560
 Zarya communications system. 197, 201, 226, 471, 524, 768
 Zarya module of International Space Station. 807, 840, 843
 Zarya village. 136, 137
 Zaykin, Dmitriy A. 246, 247, 452, 509
 Zelenyy. 248, 249, 266, 353, 374, 375, 513. *see also* Zvezdnyy Gorodok
Zemlya i usemennaya journal. 852
 Zenit reconnaissance satellites. 250, 323, 473, 590
 Zenit 2 reconnaissance satellite. 352, 354, 381, 412, 420, 473, 506
 Zenit-2M reconnaissance satellite. 634
 Zenit-4 reconnaissance satellite. 412, 453, 473, 506, 571, 723
 Zenit-4M reconnaissance satellite. 634
 Zentralwerke. 29, 35, 42
 Zernov, Pavel M. 121
 Zhukov, Georgiy K. 134
 Zhukovskiy Central Aerohydrodynamics Institute. *see* TsAGI
 Zhukovskiy Military Air Engineering Academy. 568, 606, 626-27
 Zond program. 678, 748. and end of program. 701, 743. and launch in early 1969. 678-79. and launch record. 738. and launches in late 1967 and early 1968. 610-22. *see also* LI program
 Zond 4 mission. 616-19, 666, 738
 Zond 5 mission. 653-57, 663, 666, 704, 738, 743
 Zond 6 mission. 663-65, 666, 678, 738, 743
 Zond 7 mission. 699-01, 738, 743
 Zond 8 mission. 742-43, 743
 Zritel optical sight. 294
 Zubovich, Ivan G. 38, 105
 Zvezda heavy space station. 337, 715
 Zvezda military space station. 607. and cancellation of. 633-35. and origins and design of. 596-99
 Zvezda Moon base. 834-35
 Zvezda spaceplane. 600
 Zvezdnyy Gorodok. 248, 723, 728, 792. *see also* Zelenyy
 Zvezdochka (dog). 267

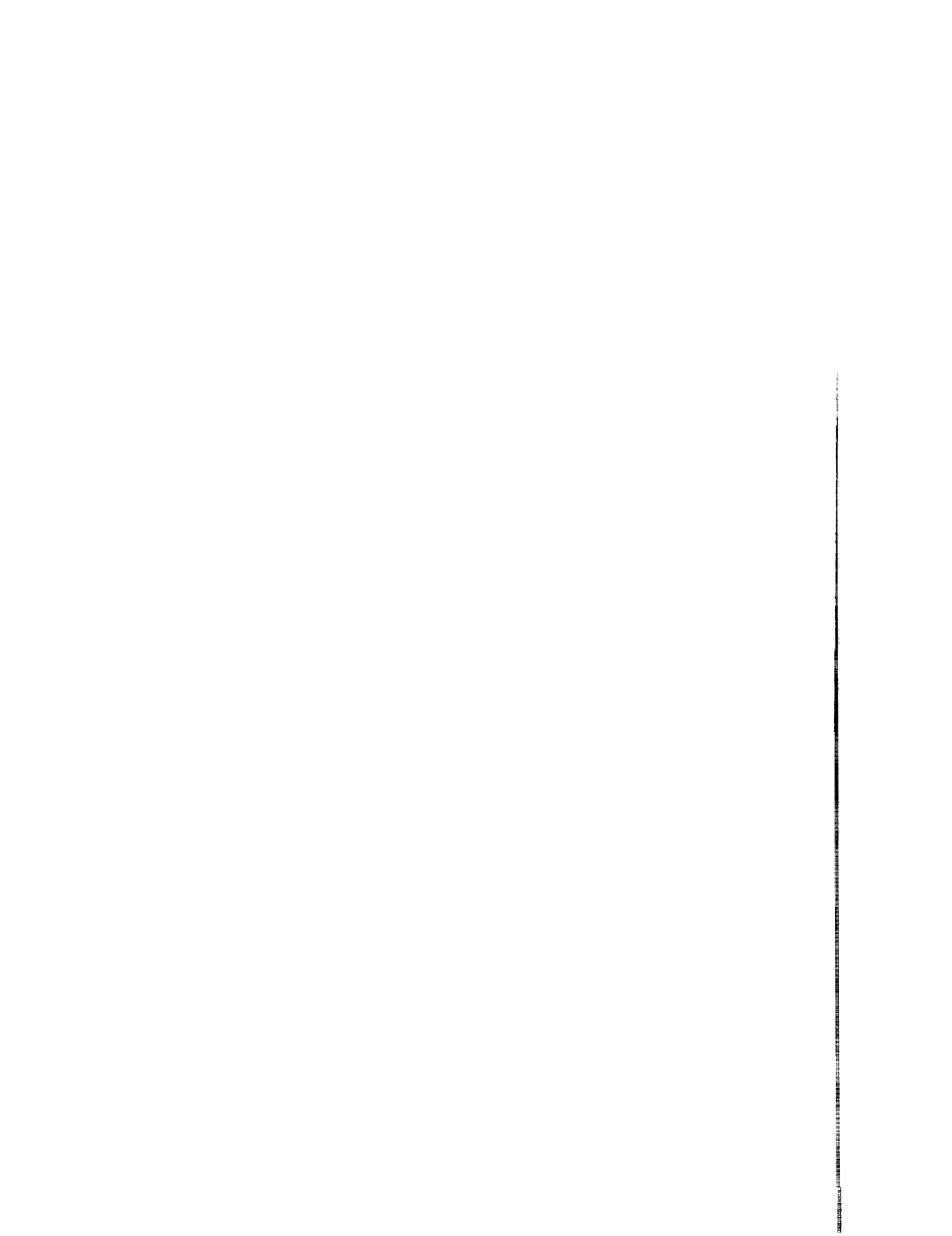

THE NASA HISTORY SERIES

Reference Works, NASA SP-4000

- Grimwood, James M. Project Mercury. A Chronology (NASA SP-4001, 1963)
- Grimwood, James M., and Hacker, Barton C., with Vorzimmer, Peter]. Project *Gemini* Technology and Operations. A Chronology (NASA SP-4002, 1969).
- Link, Mae Mills. Space Medicine in Project Mercury (NASA SP-4003, 1965)
- Astronautics and Aeronautics. 1963: Chronology of *Science*, Technology, and Policy (NASA SP-4004, 1964).
- Astronautics and Aeronautics. 1964: Chronology of *Science*, Technology, and Policy (NASA SP-4005, 1965)
- Astronautics and Aeronautics. 1965: Chronology of *Science*, Technology, and Policy (NASA SP-4006, 1966)
- Astronautics and Aeronautics. 1966: Chronology of *Science*, Technology, and Policy (NASA SP-4007, 1967)
- Astronautics and Aeronautics. 1967: Chronology of *Science*, Technology, and Policy (NASA SP-4008, 1968)
- Ertel, Ivan D., and Morse, Mary Louise. The Apollo Spacecraft. A Chronology. Volume I. Through November 7, 1962 (NASA SP-4009, 1969)
- Morse, Mary Louise, and Bays, Jean Kernahan. The Apollo *Spacecraft*. A Chronology. Volume II. November 8, 1962–September 30, 1964 (NASA SP-4009, 1973).
- Brooks, Courtney G., and Ertel, Ivan D. The Apollo Spacecraft: A Chronology, Volume III, October 1, 1964–January 20, 1966 (NASA SP-4009, 1973).
- Ertel, Ivan D., and Newkirk, Roland W., with Brooks, Courtney G. The Apollo Spacecraft: A Chronology. Volume IV, January 21, 1966–July 13, 1974 (NASA SP-4009, 1978).
- Astronautics and Aeronautics. 1968: Chronology of *Science*, Technology, and Policy (NASA SP 4010, 1969)
- Newkirk, Roland W., and Ertel, Ivan D., with Brooks, Courtney G. *Skylab*. A Chronology (NASA SP-4011, 1977).
- Van Nimmen, Jane, and Bruno, Leonard C., with Rosholt, Robert L. NASA *Historical Data Book*. Volume I. NASA Resources 1958–1968 (NASA SP 4012, 1976, rep. ed. 1988)
- Ezell, Linda Neuman. NASA *Historical Data Book*. Volume II. Programs and Projects 1958–1968 (NASA SP-4012, 1988)

Ezell Linda Neuman *NASA Historical Data Book Volume III Programs and Projects 1969-1978* (NASA SP 4012 1988)

Gawdiak Ihor Y with Fedor Helen *Compilers NASA Historical Data Book Volume IV NASA Resources 1969-1978* (NASA SP 4012 1994)

Rumernan Judy A *Compiler NASA Historical Data Book Volume V NASA Launch Systems Space Transportation Human Spaceflight, and Space Science 1979-1988* (NASA SP 4012 1999)

Rumernan Judy A. *Compiler NASA Historical Data Book. Volume VI NASA Space Applications. Aeronautics and Space Research and Technology, Tracking and Data Acquisition/Support Operations Commercial Programs, and Resources 1979-1988* (NASA SP-2000-4012, 2000)

Astronautics and Aeronautics 1969 Chronology of Science Technology, and Policy (NASA SP 4014, 1970)

Asironautcs and Aeronautics. 1970 Chronology of Science, Technology, and Policy (NASA SP-4015, 1972)

Asironautcs and Aeronautics. 1971 Chronology of Science Technology, and Policy (NASA SP-4016, 1972)

Astronautics and Aeronautics 1972 Chronology of Science Technology and Policy (NASA SP-4017 1974)

Astronautcs and Aeronautics 1973 Chronology of Science Technology and Policy (NASA SP 4018 1975)

Astronautcs and Aeronautcs 1974 Chronology of Science, Technology, and Policy (NASA SP-4019, 1977)

Astronautics and Aeronautics. 1975 Chronology of Science, Technology, and Polrcy (NASA SP-4020, 1979)

Astronautics and Aeronautcs 1976 Chronology of Science Technology and Polrcy (NASA SP-4021 1984)

Astronautics and Aeronautcs 1977 Chronology of Science Technology and Policy (NASA SP-4022 1986)

Astronautics and Aeronautics. 1978 Chronology of Science, Technology and Policy (NASA SP-4023, 1986)

Astronautics and Aeronautcs. 1979-1984 Chronology of Science, Technology and Policy (NASA SP-4024 1988)

Astronautics and Aeronautics 1985 Chronology of Scrcnce Technoiogy and Polrcy (NASA SP 4025, 1990)

Noordung Herrmann *The Problem of Space Travel The Rocket Motor Stuhlinger Ernst and Hunley J D with Garland Jennifer Editors* (NASA SP 4026 1995)

Astronautics and Aeronautics 1986-1990 A Chronology (NASA SP-4027, 1997)

Gawdiak, Ihor Y., and Shetland, Charles. *Compilers Astronautics and Aeronautics. 1991-1995 A Chronology* (NASA SP-2000-4028, 2000)

Management Histories, NASA SP-4100

Rosholt, Robert L *An Administrative History of NASA. 1958-1963* (NASA SP-4101, 1966)

Levine Arnold S *Managing NASA in the Apollo Era* (NASA SP4102 1982)

Roland Alex *Model Research The National Advisory Committee for Aeronautcs 1915-1958* (NASA SP-4103 1985)

Fries Sylvia D *NASA Engineers and the Age of Apollo* (NASA SP-4104, 1992)

Glennan, T Keith *The Birth of NASA The Diary of T Keith Glennan* Hunley, J D Editor (NASA SP-4105 1993)

CHALLENGE TO APOLLO

Seamans, Robert C. Jr. *Aiming at Targets The Autobiography of Robert C. Seamans, Jr* (NASA SP-4106 1996).

Project Histories, NASA SP-4200

Swenson, Loyd S. Jr., Grimwood, James M. and Alexander, Charles C. *This New Ocean A History of Project Mercury* (NASA SP-4201, 1966: rep. ed. 1998)

Green, Constance McL., and Lomask, Milton *Vanguard A History* (NASA SP-4202 1970, rep. ed. Smithsonian Institution Press, 1971).

Hacker, Barton C. and Grimwood, James M. *On Shoulders of Titans A History of Project Gemini* (NASA SP 4203 1977)

Benson, Charles D. and Faherty, William Barnaby *Moonport A History of Apollo Launch Facilities and Operations* (NASA SP-4204 1978)

Brooks, Courtney G. Grimwood, James M. and Swenson, Loyd S. Jr. *Chariots for Apollo A History of Manned Lunar Spacecraft* (NASA SP-4205 1979)

Bilstein, Roger E. *Stages to Saturn A Technological History of the Apollo/Saturn Launch Vehicles* (NASA SP-4206 1980 rep. ed. 1997)

SP-4207 not published

Compton, W. David and Benson, Charles D. *Living and Working in Space A History of Skylab* (NASA SP-4208 1983)

Ezell, Edward Clinton and Ezell, Linda Neuman *The Partnership A History of the Apollo Soyuz Test Project* (NASA SP-4209 1978)

Hall, R. Cargill *Lunar Impact A History of Project Ranger* (NASA SP-4210, 1977)

Newell, Homer E. *Beyond the Atmosphere Early Years of Space Science* (NASA SP 4211, 1980)

Ezell, Edward Clinton, and Ezell, Linda Neuman. *On Mars Exploration of the Red Planet, 1958-1978* (NASA SP-4212, 1984).

Pitts, John A. *The Human Factor Biomedicine in the Manned Space Program to 1980* (NASA SP-4213 1985)

Compton, W. David *Where No Man Has Gone Before A History of Apollo Lunar Exploration Missions* (NASA SP-4214 1989)

Naugle, John E. *First Among Equals The Selection of NASA Space Science Experiments* (NASA SP-4215, 1991)

Wallace, Lane E. *Airborne Trailblazer Two Decades with NASA Langley's Boeing 737 Flying Laboratory* (NASA SP-4216, 1994)

Butrica, Andrew J. Editor *Beyond the Ionosphere: Fifty Years of Satellite Communication* (NASA SP-4217, 1997).

Butrica, Andrew J. *To See the Unseen A History of Planetary Radar Astronomy* (NASA SP-4218, 1996)

Mack, Pamela E. Editor *From Engineering Science to Bragg Science The NACA and NASA Collier Trophy Research Project Winners* (NASA SP-4219, 1998).

Reed, R. Dale With Lister, Darlene *Wingless Flight The Lifting Body Story* (NASA SP-4220, 1997)

Heppenheimer T A *The Space Shuttle Decision: NASA's Search for a Reusable Space Vehicle* (NASA SP-4221, 1999)

Hunley, J D Editor. *Toward Mach 2: The Douglas D-558 Program* (NASA SP-4222, 1999)

Swanson Glen E Editor. *"Before This Decade Is Out" - Personal Reflections on the Apollo Program* (NASA SP-4223, 1999)

Center Histories, NASA SP-4300

Rosenthal. Alfred *Venture into Space: Early Years of Goddard Space Flight Center* (NASA SP-4301, 1985)

Hartman, Edwin. P. *Adventures in Research: A History of Ames Research Center, 1940-1965* (NASA SP-4302, 1970)

Hallion Richard P *On the Frontier: Flight Research at Dryden, 1946-1981* (NASA SP-4303, 1984)

Muenger, Elizabeth A *Searching the Horizon: A History of Ames Research Center, 1940-1976* (NASA SP-4304, 1985)

Hansen James R *Engineer in Charge: A History of the Langley Aeronautical Laboratory 1917-1958* (NASA SP-4305, 1987)

Dawson Virginia P *Engines and Innovation: Lewis Laboratory and American Propulsion Technology* (NASA SP-4306, 1991)

Dethloff, Henry C *"Suddenly Tomorrow Came...": A History of the Johnson Space Center* (NASA SP-4307, 1993)

Hansen, James R *Spaceflight Revolution: NASA Langley Research Center from Sputnik to Apollo* (NASA SP-4308, 1995)

Wallace, Lane E *Flights of Discovery: 50 Years at the NASA Dryden Flight Research Center* (NASA SP-4309, 1996)

Herring Mack R *Way Station to Space: A History of the John C. Stennis Space Center* (NASA SP-4310, 1997)

Wallace, Harold D. Jr. *Wallops Station and the Creation of the American Space Program* (NASA SP-4311, 1997)

Wallace, Lane E *Dreams, Hopes, Realities: NASA's Goddard Space Flight Center, The First Forty Years* (NASA SP-4312, 1999)

Dunar, Andrew J. and Waring, Stephen P *Power to Explore: A History of Marshall Space Flight Center, 1960-1990* (NASA SP-4313, 1999)

General Histories, NASA SP-4400

Corliss William R *NASA Sounding Rockets 1958-1968: A Historical Summary* (NASA SP-4401, 1971)

Wells, Helen T., Whiteley, Susan H., and Karegeannes, Carrie. *Origins of NASA Names* (NASA SP-4402, 1976)

Anderson Frank W. Jr *Orders of Magnitude: A History of NACA and NASA, 1915-1980* (NASA SP-4403, 1981)

Sloop, John L *Liquid Hydrogen as a Propulsion Fuel, 1945-1959* (NASA SP-4404, 1978)

Roland, Alex *A Spacefaring People: Perspectives on Early Spaceflight* (NASA SP-4405, 1985)

CHALLENGE TO APOLLO

THE NASA HISTORY SERIES

Bilstein, Roger E. *Orders of Magnitude: A History of the NACA and NASA, 1915-1990* (NASA SP-4406, 1989).

Logsdon, John M., Editor. With Lear, Linda J., Warren-Findley, Jannelle, Williamson, Ray A., and Day, Dwayne A. *Exploring the Unknown: Selected Documents in the History of the U.S. Civil Space Program, Volume I: Organizing for Exploration* (NASA SP-4407, 1995).

Logsdon, John M., Editor. With Day, Dwayne A., and Launius, Roger D. *Exploring the Unknown: Selected Documents in the History of the U.S. Civil Space Program, Volume II: External Relationships* (NASA SP-4407, 1996).

Logsdon, John M., Editor. With Launius, Roger D., Onkst, David H., and Garber, Stephen E. *Exploring the Unknown: Selected Documents in the History of the U.S. Civil Space Program, Volume III: Using Space* (NASA SP-4407, 1998).

Logsdon, John M., Editor. With Williamson, Ray A., Launius, Roger D., Acker, Russell J., Garber, Stephen J., and Friedman, Jonathan L. *Exploring the Unknown: Selected Documents in the History of the U.S. Civil Space Program, Volume IV: Accessing Space* (NASA SP-4407, 1999).

